

EN

User manual

Fridge Freezer

USER MANUAL

ZRB632FW

ZRB634FW

ZRB638FW

[Downloaded from Fridge-Manual.com](http://Fridge-Manual.com) Manuals

la vita è bella

ZANUSSI

ITALIAN SINCE 1916

Contents

Safety information	2	Care and cleaning	6
Operation	4	What to do if... ..	7
First use	4	Technical data	9
Daily use	4	Installation	9
Helpful hints and tips	5	Environmental concerns	12

Subject to change without notice



Safety information

In the interest of your safety and to ensure the correct use, before installing and first using the appliance, read this user manual carefully, including its hints and warnings. To avoid unnecessary mistakes and accidents, it is important to ensure that all people using the appliance are thoroughly familiar with its operation and safety features. Save these instructions and make sure that they remain with the appliance if it is moved or sold, so that everyone using it through its life will be properly informed on appliance use and safety.

For the safety of life and property keep the precautions of these user's instructions as the manufacturer is not responsible for damages caused by omission.

Children and vulnerable people safety

- This appliance is not intended for use by persons (including children) with reduced physical, sensory or mental capabilities, or lack of experience and knowledge, unless they have been given supervision or instruction concerning use of the appliance by a person responsible for their safety.
Children should be supervised to ensure that they do not play with the appliance.
- Keep all packaging well away from children. There is risk of suffocation.
- If you are discarding the appliance pull the plug out of the socket, cut the connection cable (as close to the appliance as you can) and remove the door to prevent playing children to suffer electric shock or to close themselves into it.
- If this appliance featuring magnetic door seals is to replace an older appliance having a spring lock (latch) on the door or lid, be sure to make that spring lock unusable before you discard the old appliance. This will prevent it from becoming a death trap for a child.

General safety



Caution! Keep ventilation openings clear of obstruction.

- The appliance is intended for keeping foodstuff and/or beverages in a normal household as explained in this instruction booklet.
- Do not use a mechanical device or any artificial means to speed up the thawing process.
- Do not use other electrical appliances (such as ice cream makers) inside of refrigerating appliances, unless they are approved for this purpose by the manufacturer.
- Do not damage the refrigerant circuit.
- The refrigerant isobutane (R600a) is contained within the refrigerant circuit of the appliance, a natural gas with a high level of environmental compatibility, which is nevertheless flammable.
During transportation and installation of the appliance, be certain that none of the components of the refrigerant circuit become damaged.
If the refrigerant circuit should become damaged:
 - avoid open flames and sources of ignition
 - thoroughly ventilate the room in which the appliance is situated
- It is dangerous to alter the specifications or modify this product in any way. Any damage to the cord may cause a short-circuit, fire and/or electric shock.



Warning! Any electrical component (power cord, plug, compressor) must be replaced by a certified service agent or qualified service personnel to avoid hazard.

1. Power cord must not be lengthened.
2. Make sure that the power plug is not squashed or damaged by the back of the appliance. A squashed

or damaged power plug may overheat and cause a fire.

3. Make sure that you can come to the mains plug of the appliance.
 4. Do not pull the mains cable.
 5. If the power plug socket is loose, do not insert the power plug. There is a risk of electric shock or fire.
 6. You must not operate the appliance without the lamp cover¹⁾ of interior lighting.
- This appliance is heavy. Care should be taken when moving it.
 - Do not remove nor touch items from the freezer compartment if your hands are damp/wet, as this could cause skin abrasions or frost/freezer burns.
 - Avoid prolonged exposure of the appliance to direct sunlight.
 - Bulb lamps²⁾ used in this appliance are special purpose lamps selected for household appliances use only. They are not suitable for household room illumination.

Daily Use

- Do not put hot pot on the plastic parts in the appliance.
- Do not store flammable gas and liquid in the appliance, because they may explode.
- Do not place food products directly against the air outlet on the rear wall.³⁾
- Frozen food must not be re-frozen once it has been thawed out.
- Store pre-packed frozen food in accordance with the frozen food manufacturer's instructions.
- Appliance's manufacturers storage recommendations should be strictly adhered to. Refer to relevant instructions.
- Do not place carbonated or fizzy drinks in the freezer compartment as it creates pressure on the container, which may cause it to explode, resulting in damage to the appliance.
- Ice lollies can cause frost burns if consumed straight from the appliance.

1) If the lamp cover is foreseen.

2) If the lamp is foreseen.

3) If the appliance is Frost Free.

4) If a water connection is foreseen.

Care and cleaning

- Before maintenance, switch off the appliance and disconnect the mains plug from the mains socket.
- Do not clean the appliance with metal objects.
- Do not use sharp objects to remove frost from the appliance. Use a plastic scraper.
- Regularly examine the drain in the refrigerator for defrosted water. If necessary, clean the drain. If the drain is blocked, water will collect in the bottom of the appliance.

Installation

Important! For electrical connection carefully follow the instructions given in specific paragraphs.

- Unpack the appliance and check if there are damages on it. Do not connect the appliance if it is damaged. Report possible damages immediately to the place you bought it. In that case retain packing.
- It is advisable to wait at least four hours before connecting the appliance to allow the oil to flow back in the compressor.
- Adequate air circulation should be around the appliance, lacking this leads to overheating. To achieve sufficient ventilation follow the instructions relevant to installation.
- Wherever possible the back of the product should be against a wall to avoid touching or catching warm parts (compressor, condenser) to prevent possible burn.
- The appliance must not be located close to radiators or cookers.
- Make sure that the mains plug is accessible after the installation of the appliance.
- Connect to potable water supply only. ⁴⁾

Service

- Any electrical work required to do the servicing of the appliance should be carried out by a qualified electrician or competent person.
- This product must be serviced by an authorized Service Centre, and only genuine spare parts must be used.

Environment Protection

 This appliance does not contain gasses which could damage the ozone layer, in either its refrigerant circuit or insulation materials. The appliance shall not be discarded together with the urban refuse and rubbish. The

insulation foam contains flammable gases: the appliance shall be disposed according to the applicable regulations to obtain from your local authorities. Avoid damaging the cooling unit, especially at the rear near the heat exchanger. The materials used on this appliance marked by the symbol  are recyclable.

Operation

Switching on

Insert the plug into the wall socket.
Turn the Temperature regulator clockwise to a medium setting.

Switching off

To turn off the appliance, turn the Temperature regulator to the "0" position.

Temperature regulation

The temperature is automatically regulated.
To operate the appliance, proceed as follows:

- turn the Temperature regulator toward lower settings to obtain the minimum coldness.
- turn the Temperature regulator toward higher settings to obtain the maximum coldness.

 A medium setting is generally the most suitable.

However, the exact setting should be chosen keeping in mind that the temperature inside the appliance depends on:

- room temperature
- how often the door is opened
- the quantity of food stored
- the location of the appliance.

Important! If the ambient temperature is high or the appliance is fully loaded, and the appliance is set to the lowest temperatures, it may run continuously causing frost to form on the rear wall. In this case the dial must be set to a higher temperature to allow automatic defrosting and therefore reduced energy consumption.

First use

Cleaning the interior

Before using the appliance for the first time, wash the interior and all internal accessories with lukewarm water and some neutral soap so as to remove the typical smell of a brand-new product, then dry thoroughly.

Important! Do not use detergents or abrasive powders, as these will damage the finish.

Daily use

Freezing fresh food

The freezer compartment is suitable for freezing fresh food and storing frozen and deep-frozen food for a long time.

To freeze fresh foods it is not necessary to change the medium setting.

However, for a faster freezing operation, turn the temperature regulator toward higher settings to obtain the maximum coldness.

Important! In this condition, the refrigerator compartment temperature might drop below 0°C. If this occurs reset the temperature regulator to a warmer setting.

Place the fresh food to be frozen on the top compartment.

Storage of frozen food

When first starting-up or after a period out of use, before putting the products in the compartment let the appliance run at least 2 hours on the higher settings.

Important! In the event of accidental defrosting, for example due to a power failure, if the power has been off for longer than the value shown in the technical characteristics chart under "rising time", the defrosted food must be consumed quickly or cooked immediately and then re-frozen (after cooling).

Thawing

Deep-frozen or frozen food, prior to being used, can be thawed in the refrigerator compartment or at room temperature, depending on the time available for this operation. Small pieces may even be cooked still frozen, directly from the freezer: in this case, cooking will take longer.

Movable shelves

The walls of the refrigerator are equipped with a series of runners so that the shelves can be positioned as desired.

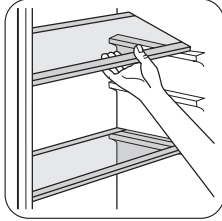

Positioning the door shelves

To permit storage of food packages of various sizes, the door shelves can be placed at different heights.

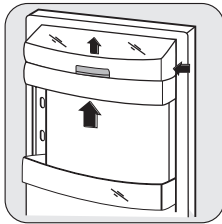

Gradually pull the shelf in the direction of the arrows until it comes free, then reposition as required.

Bottle rack

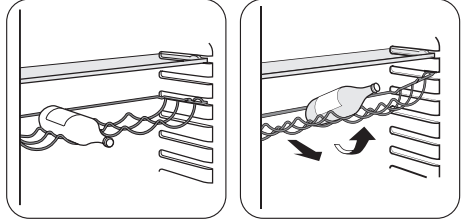

Place the bottles (with the opening facing front) in the pre-positioned shelf.

Important! If the shelf is positioned horizontally, place only closed bottles.

This bottle holder shelf can be tilted in order to store previously opened bottles. To obtain this result, pull the shelf up so it can rotate upwards and be placed on the next higher level.

Removal of freezing baskets from the freezer

The freezing baskets have a limit stop to prevent their accidental removal or falling out. At the time of its removal from the freezer, pull the basket towards yourself and, upon reaching the end point, remove the basket by tilting its front upwards.

At the time of putting it back, slightly lift the front of the basket to insert it into the freezer. Once you are over the end points, push the baskets back in their position.

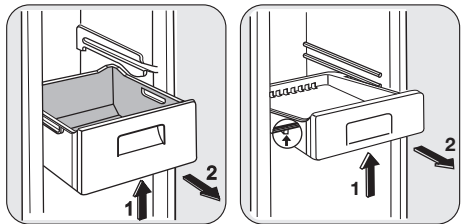

Helpful hints and tips

Hints for energy saving

- Do not open the door frequently or leave it open longer than absolutely necessary.
- If the ambient temperature is high and the Temperature Regulator is set to low temperature and the appliance is fully loaded, the compressor may run continuously,

causing frost or ice on the evaporator. If this happens, set the Temperature Regulator toward warmer settings to allow automatic defrosting and so a saving in electricity consumption.

Hints for fresh food refrigeration

To obtain the best performance:

- do not store warm food or evaporating liquids in the refrigerator
- do cover or wrap the food, particularly if it has a strong flavour
- position food so that air can circulate freely around it

Hints for refrigeration

Useful hints:

Meat (all types) : wrap in polythene bags and place on the glass shelf above the vegetable drawer.

For safety, store in this way only one or two days at the most.

Cooked foods, cold dishes, etc...: these should be covered and may be placed on any shelf.

Fruit and vegetables: these should be thoroughly cleaned and placed in the special drawer(s) provided.

Butter and cheese: these should be placed in special airtight containers or wrapped in aluminium foil or polythene bags to exclude as much air as possible.

Milk bottles: these should have a cap and should be stored in the bottle rack on the door.

Bananas, potatoes, onions and garlic, if not packed, must not be kept in the refrigerator.

Hints for freezing

To help you make the most of the freezing process, here are some important hints:

- the maximum quantity of food which can be frozen in 24 hrs. is shown on the rating plate;
- the freezing process takes 24 hours. No further food to be frozen should be added during this period;
- only freeze top quality, fresh and thoroughly cleaned, foodstuffs;

Care and cleaning



Caution! Unplug the appliance before carrying out any maintenance operation.



This appliance contains hydrocarbons in its cooling unit; maintenance and recharging must therefore only be carried out by authorized technicians.

Periodic cleaning

The equipment has to be cleaned regularly:

- clean the inside and accessories with lukewarm water and some neutral soap.
- regularly check the door seals and wipe clean to ensure they are clean and free from debris.

- prepare food in small portions to enable it to be rapidly and completely frozen and to make it possible subsequently to thaw only the quantity required;
- wrap up the food in aluminium foil or polythene and make sure that the packages are airtight;
- do not allow fresh, unfrozen food to touch food which is already frozen, thus avoiding a rise in temperature of the latter;
- lean foods store better and longer than fatty ones; salt reduces the storage life of food;
- water ices, if consumed immediately after removal from the freezer compartment, can possibly cause the skin to be freeze burnt;
- it is advisable to show the freezing in date on each individual pack to enable you to keep tab of the storage time.

Hints for storage of frozen food

To obtain the best performance from this appliance, you should:

- make sure that the commercially frozen foodstuffs were adequately stored by the retailer;
- be sure that frozen foodstuffs are transferred from the foodstore to the freezer in the shortest possible time;
- not open the door frequently or leave it open longer than absolutely necessary.
- Once defrosted, food deteriorates rapidly and cannot be refrozen.
- Do not exceed the storage period indicated by the food manufacturer.

- rinse and dry thoroughly.

Important! Do not pull, move or damage any pipes and/or cables inside the cabinet.

Never use detergents, abrasive powders, highly perfumed cleaning products or wax polishes to clean the interior as this will damage the surface and leave a strong odour.

Clean the condenser (black grill) and the compressor at the back of the appliance with a brush or a vacuum cleaner. This operation will improve the performance of the appliance and save electricity consumption.

Important! Take care of not to damage the cooling system.

Many proprietary kitchen surface cleaners contain chemicals that can attack/damage the plastics used in this appliance. For this reason it is recommended that the outer casing of this appliance is only cleaned with warm water with a little washing-up liquid added.

After cleaning, reconnect the equipment to the mains supply.

Defrosting of the refrigerator

Frost is automatically eliminated from the evaporator of the refrigerator compartment every time the motor compressor stops, during normal use. The defrost water drains out through a trough into a special container at the back of the appliance, over the motor compressor, where it evaporates.

It is important to periodically clean the defrost water drain hole in the middle of the refrigerator compartment channel to prevent the water overflowing and dripping onto the food inside. Use the special cleaner provided, which you will find already inserted into the drain hole.

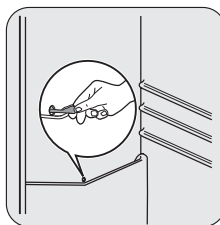

Defrosting of the freezer

The freezer compartment of this model, on the other hand, is a "no frost" type. This means that there is no buildup of frost when it is in operation, neither on the internal walls nor on the foods.

The absence of frost is due to the continuous circulation of cold air inside the compartment, driven by an automatically controlled fan.

What to do if...

⚠ Caution! Before troubleshooting, disconnect the power supply.

Only a qualified electrician or competent person must do the troubleshooting that is not in this manual.

Important! There are some sounds during normal use (compressor, refrigerant circulation).

Problem	Possible cause	Solution
The appliance is noisy.	The appliance is not supported properly.	Check if the appliance stands stable (all the four feet should be on the floor).
The compressor operates continually.	The Temperature regulator may be set incorrectly.	Set a warmer temperature.
	The door is not closed correctly.	Refer to "Closing the door".
	The door has been opened too frequently.	Do not keep the door open longer than necessary.
	The product temperature is too high.	Let the product temperature decrease to room temperature before storage.
	The room temperature is too high.	Decrease the room temperature.
Water flows on the rear plate of the refrigerator.	During the automatic defrosting process, frost defrosts on the rear plate.	This is correct.
Water flows into the refrigerator.	The water outlet is clogged.	Clean the water outlet.
	Products prevent that water flows into the water collector.	Make sure that products do not touch the rear plate.

Problem	Possible cause	Solution
Water flows on the ground.	The melting water outlet does not flow in the evaporative tray above the compressor.	Attach the melting water outlet to the evaporative tray.
There is too much frost and ice.	Products are not wrapped properly.	Wrap the products better.
	The door is not closed correctly.	Refer to "Closing the door".
	The Temperature regulator may be set incorrectly.	Set a higher temperature.
The temperature in the appliance is too low.	The Temperature regulator may be set incorrectly.	Set a higher temperature.
The temperature in the appliance is too high.	The Temperature regulator may be set incorrectly.	Set a lower temperature.
	The door is not closed correctly.	Refer to "Closing the door".
	The product temperature is too high.	Let the product temperature decrease to room temperature before storage.
	Many products are stored at the same time.	Store less products at the same time.
The temperature in the refrigeration is too high.	There is no cold air circulation in the appliance.	Make sure that there is cold air circulation in the appliance.
The temperature in the freezer is too high.	Products are too near to each other.	Store products so that there is cold air circulation.
The appliance does not operate.	The appliance is switched off.	Switch on the appliance.
	The mains plug is not connected to the mains socket correctly.	Connect the mains plug to the mains socket correctly.
	The appliance has no power. There is no voltage in the mains socket.	Connect a different electrical appliance to the mains socket. Contact a qualified electrician.
The lamp does not work.	The lamp is in stand-by.	Close and open the door.
	The lamp is defective.	Refer to "Replacing the lamp".

If your appliance is still not working properly after making the above checks, contact the After Sales Centre.

Replacing the lamp

1. Disconnect the appliance.
2. Push the movable part to unhook the lamp cover (1).
3. Remove the lamp cover (2).
4. Replace the lamp with one of the same power and specifically designed for domestic appliances only.
5. Install the lamp cover.
6. Connect the appliance.

7. Open the door. Make sure that the lamp comes on.

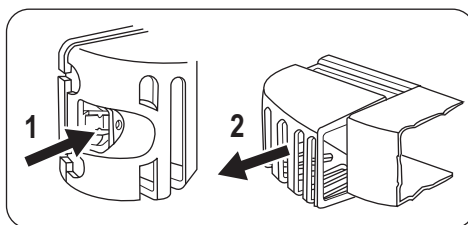

Closing the door

1. Clean the door gaskets.

2. If necessary, adjust the door. Refer to "Installation".

3. If necessary, replace the defective door gaskets. Contact the Service Center.

Technical data

		ZRB632FW	ZRB634FW	ZRB638FW
Dimension				
	Height	1750 mm	1850 mm	2010 mm
	Width	595 mm	595 mm	595 mm
	Depth	658 mm	658 mm	658 mm
Rising Time		16 h	18 h	18 h
Voltage		230 V	230 V	230 V
Frequency		50 Hz	50 Hz	50 Hz

The technical information are situated in the rating plate on the internal left side of the appliance and in the energy label.

Installation

! **Caution!** Read the "Safety Information" carefully for your safety and correct operation of the appliance before installing the appliance.

Positioning

Install this appliance at a location where the ambient temperature corresponds to the climate class indicated on the rating plate of the appliance:

Climate class	Ambient temperature
SN	+10°C to + 32°C
N	+16°C to + 32°C
ST	+16°C to + 38°C
T	+16°C to + 43°C

Location

The appliance should be installed well away from sources of heat such as radiators, boilers, direct sunlight etc. Ensure that air can circulate freely around the back of the cabinet. To ensure best performance, if the appliance is positioned below an overhanging wall unit, the minimum distance between the top of the cabinet and the wall unit must be at least 100 mm. Ideally, however, the appliance should not be positioned below overhanging wall units.

Accurate levelling is ensured by one or more adjustable feet at the base of the cabinet.

! **Warning!** It must be possible to disconnect the appliance from the mains power supply; the plug must therefore be easily accessible after installation.

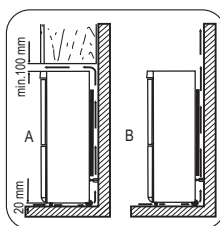

Electrical Connection

! **Caution!** Any electrical work required to install this appliance should be carried out by a qualified electrician or competent person.

! **Warning!** This appliance must be earthed. The manufacturer declines any liability should these safety measures not be observed.

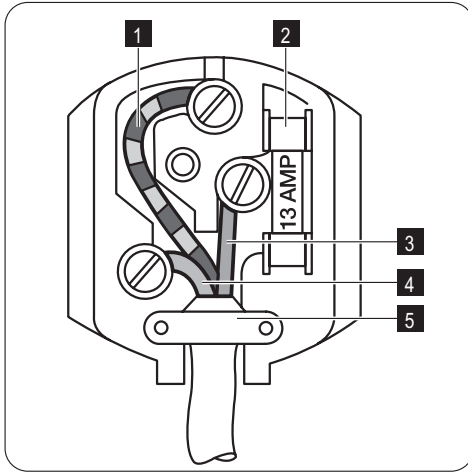

Important! The wires in the mains lead are coloured in accordance with the following code:

- | | | |
|----------|-------------------|---------|
| 1 | Green and Yellow: | Earth |
| 3 | Brown: | Live |
| 5 | Blue: | Neutral |

As the colours of the wires in the mains lead of this appliance may not correspond with the coloured markings identifying the terminals in your plug, proceed as follows:

1. Connect the wire coloured green and yellow to the terminal marked either with the letter "E" or by the earth symbol \oplus or coloured green and yellow.
2. Connect the wire coloured blue to the terminal either marked with the letter "N" or coloured black.
3. Connect the wire coloured brown to the terminal either marked with the "L" or coloured red.
4. Check that no cut, or stray strands of wire is present and the cord clamp **4** is secure over the outer sheath.
5. Make sure the electricity supply voltage is the same as that indicated on the appliance rating plate.
6. Switch on the appliance.

The appliance is supplied with a 13 amp plug fitted **2**. In the event of having to change the fuse in the plug supplied, a 13 amp ASTA approved (BS 1362) fuse must be used.

Warning! A cut off plug inserted into a 13 amp socket is a serious safety (shock) hazard. Ensure that it is disposed of safely.

Rear spacers

You can find the two spacers in the bag with documentation.

Do these steps to install the spacers:

1. Release the screw.
2. Engage the spacer below the screw.
3. Turn the spacer to the right position.
4. Tighten again the screws.

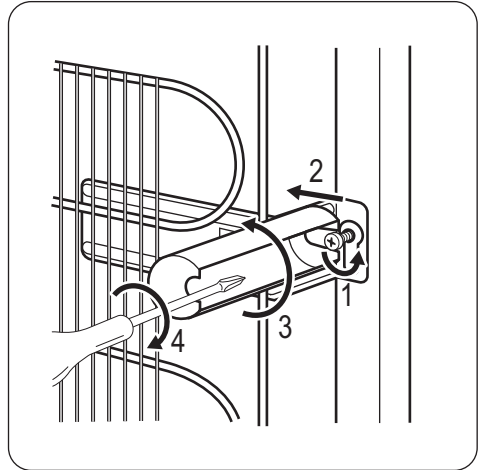

Levelling

When placing the appliance ensure that it stands level. This can be achieved by two adjustable feet at the bottom in front.

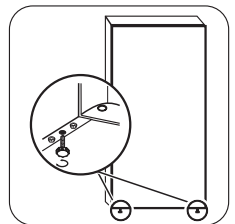

Removing the shelf holders

Your appliance is equipped with shelf retainers that make it possible to secure the shelves during transportation.

To remove them proceed as follows:

1. Move the shelf holders in the direction of the arrow (A).
2. Raise the shelf from the rear and push it forward until it is freed (B).
3. Remove the retainers (C).

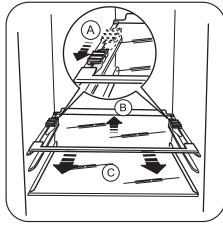

Door reversibility

Warning! Before carrying out any operations, remove the plug from the power socket.

Important! To carry out the following operations, we suggest that this be made with another person that will keep a firm hold on the doors of the appliance during the operations.

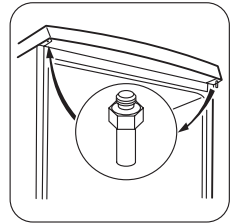
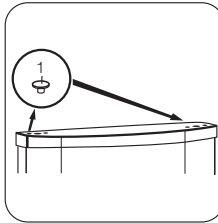
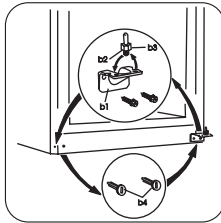
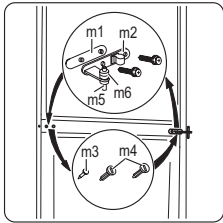

- Open the doors. Unscrew the middle hinge (m2). Remove the plastic spacer (m1).
- Remove the spacer (m6) and move to the other side of the hinge pivot (m5).
- Remove the doors.
- Remove the left-hand cover pin of the middle hinge (m3,m4) and move to the other side.
- Fit the pin of the middle hinge (m5) into the left-hand hole of the lower door.
- Unscrew the lower hinge (b1)
- Remove the left-hand cover pins (b4) and move to the other side.
- Re-screw the lower hinge (b1) on the opposite side.
- Unscrew the lower hinge pivot (b2) and the spacer (b3) and place them on the opposite side.
- Remove the plugs (1) on the upper side of both doors and move them to the other side.
- Re-insert the lower door on the lower hinge pivot (b2).
- Insert the middle hinge (m2) into the left drill of the lower door.
- Unscrew the upper hinge pivot and place it on the opposite side.
- Fit the upper door on the upper door pivot.
- Re-insert the upper door on the middle hinge pivot (m5) slightly tilting both doors.
- Re-screw the middle hinge (m2). Do not forget the plastic spacer (m1).

Do a final check to make sure that:

- All screws are tightened.
- The edges of the doors run parallel to the side edge of the appliance.
- The magnetic seal adheres to the cabinet.
- The door opens and closes correctly.

If the ambient temperature is cold (i.e. in Winter), the gasket may not fit perfectly to the cabinet. In that case, wait for the natural fitting of the gasket.

In case you do not want to carry out the above mentioned operations, contact the nearest After Sales Service Force. The After Sales Service specialist will carry out the reversibility of the doors at your cost.

Environmental concerns

The symbol  on the product or on its packaging indicates that this product may not be treated as household waste. Instead it should be taken to the appropriate collection point for the recycling of electrical and electronic equipment. By ensuring this product is disposed of correctly, you will help prevent potential

negative consequences for the environment and human health, which could otherwise be caused by inappropriate waste handling of this product. For more detailed information about recycling of this product, please contact your local council, your household waste disposal service or the shop where you purchased the product.



www.zanussi.com/shop

