



user manual

Washing Machine

EWF 86110W
EWF 106110W
EWF 126110W

Electrolux. Thinking of you.

Share more of our thinking at www.electrolux.com

Contents

| | | | |
|------------------------|----|-----------------------|----|
| Safety information | 2 | Care and cleaning | 13 |
| Product description | 4 | What to do if... | 16 |
| Control panel | 5 | Technical data | 19 |
| First use | 7 | Consumption values | 19 |
| Daily use | 7 | Installation | 20 |
| Helpful hints and tips | 9 | Electrical connection | 23 |
| Washing programmes | 11 | Environment concerns | 23 |

Subject to change without notice



Safety information

Important! Read carefully & keep for future reference.

- The safety of Your appliance complies with the industry standards and with legal requirements on the safety of appliances. However, as manufacturers, we feel it is our duty to provide the following safety notes.
- It is most important that this instruction book should be retained with the appliance for future reference. Should the appliance be sold or transferred to another owner, or should you move house and leave the appliance, always ensure that the book is supplied with the appliance in order that the new owner can get to know the functioning of the appliance and the relevant warnings.
- You **MUST** read them carefully before installing or using the appliance.
- Before first starting up, check the appliance for any damage incurred during transport. Never connect up a damaged appliance. If parts are damaged, contact your supplier.
- If the appliance is delivered in the winter months when there are minus temperatures. Store it at room temperature for 24 hours before using for the first time.

General safety

- It is dangerous to alter the specifications or attempt to modify this product in any way.
- During high temperature wash programmes the door glass may get hot. Do not touch it!

- Make sure that small pets do not climb into the drum. To avoid this, please check into the drum before using.
- Any objects such as coins, safety pins, nails, screws, stones or any other hard, sharp material can cause extensive damage and must not be placed into the machine.
- Only use the advised quantities of fabric softener and detergent. Damage to the fabric can ensue if you over-fill. Refer to the manufacturer's recommendations of quantities.
- Wash small items such as socks, laces, washable belts etc in a washing bag or pillow case as it is possible for such items to slip down between the tub and the inner drum.
- Do not use your washing machine to wash articles with whalebones, material without hems or torn material.
- Always unplug the appliance and turn off the water supply after use, cleaning and maintenance.
- Under no circumstances should you attempt to repair the machine yourself. Repairs carried out by inexperienced people may cause injury or serious malfunctioning. Contact your local Service Centre. Always insist on genuine spare parts.

Installation

- This appliance is heavy. Care should be taken when moving it.
- When unpacking the appliance, check that it is not damaged. If in doubt, do not use it and contact the Service Centre.

- All packing and transit bolts must be removed before use. Serious damage can occur to the product and to property if this is not adhered to. See relevant section in the user manual.
- After having installed the appliance, check that it is not standing on the inlet and drain hose and the worktop is not pressing the electrical supply cable against the wall.
- If the machine is situated on a carpeted floor, please adjust the feet in order to allow air to circulate freely under the appliance.
- Always be sure, that there is no water leakage from hoses and their connections after the installation.
- If the appliance is installed in a location subject to frost, please read the “dangers of freezing” chapter.
- Any plumbing work required to install this appliance should be carried out by a qualified plumber or competent person.
- Any electrical work required to install this appliance should be carried out by a qualified electrician or competent person.

Use

- This appliance is designed for domestic use. It must not be used for purposes other than those for which it was designed.
- Only wash fabrics which are designed to be machine washed. Follow the instructions on each garment label.
- Do not overload the appliance. See the Washing Programme Table.
- Before washing, ensure that all pockets are empty and buttons and zips are fastened. Avoid washing frayed or torn articles and treat stains such as paint, ink, rust, and grass before washing. Under-wired bras must NOT be machine washed.
- Garments which have been in contact with volatile petroleum products should not be machine washed. If volatile cleaning fluids are used, care should be taken to ensure that the fluid is removed from the garment before placing in the machine.
- Never pull the power supply cable to remove the plug from the socket; always take hold of the plug itself.

- Never use the appliance if the power supply cable, the control panel, the working surface or the base are damaged so that the inside of the washing machine is accessible.

Child safety

- This appliance is not intended for use by person (including children) with reduced physical sensory or mental capabilities or lack of experience and knowledge unless they have been given supervision or instruction concerning use of the appliance by a person responsible for their safety.
- The packaging components (e.g. plastic film, polystyrene) can be dangerous to children - danger of suffocation! Keep them out of children's reach.
- Keep all detergents in a safe place out of children's reach.
- Make sure that children or pets do not climb into the drum. To prevent children and pets becoming trapped inside the drum the machine incorporates a special feature. To activate this device, rotate the button (without pressing it) inside the door clockwise until the groove is horizontal. If necessary use a coin.

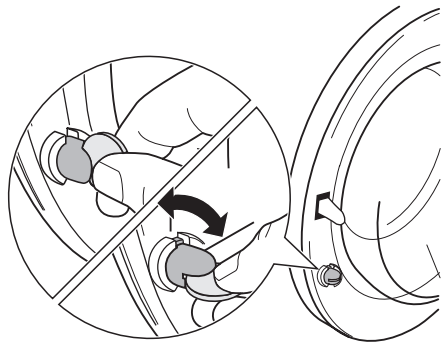

To disable this device and restore the possibility of closing the door, rotate the button counterclockwise until the groove is vertical.

Product description

i Your new appliance meets all modern requirements for effective treatment of laundry with low water, energy and detergent consumption. Its new washing system allows total use of detergent and reduces water consumption so saving energy.

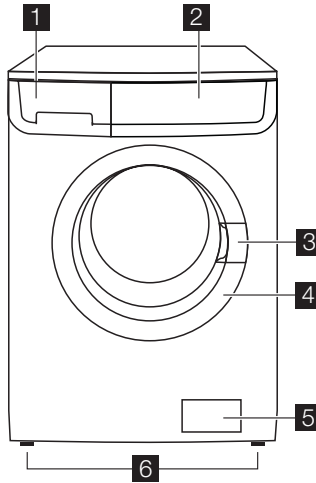

1 Detergent dispenser drawer

2 Control panel

3 Door opening handle

4 Rating Plate

5 Drain pump

6 Adjustable feet

Detergent dispenser drawer

 Compartment for detergent used for pre-wash and soak phase or for stain remover used during the stain action phase (if available). The prewash and soak detergent is added at the beginning of the wash programme. The stain remover is added during the stain action phase.

 Compartment for powder or liquid detergent used for main wash. If using liquid detergent pour it **just before** starting the programme.

 Compartment for liquid additives (fabric softener, starch).

Follow the product manufacturer's recommendations on quantities to use and do not exceed the «**MAX**» mark in the detergent dispenser drawer. Any fabric softener or starching additives must be poured into the compartment before starting the wash programme.

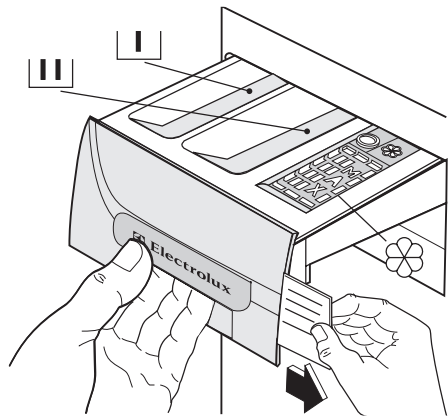

Programme Chart

Various programme charts in different languages are supplied with the appliance. One is on the front side of the detergent dispenser drawer and the others are attached into the

user manual assy. The chart in the drawer can be replaced easily: remove the chart from the drawer by pulling it towards the right and insert the chart with the language required.

Control panel

i Below is a picture of the control panel. It shows the programme selector dial as well as the buttons and the pilot lights. These are presented by relevant numbers on the following pages.

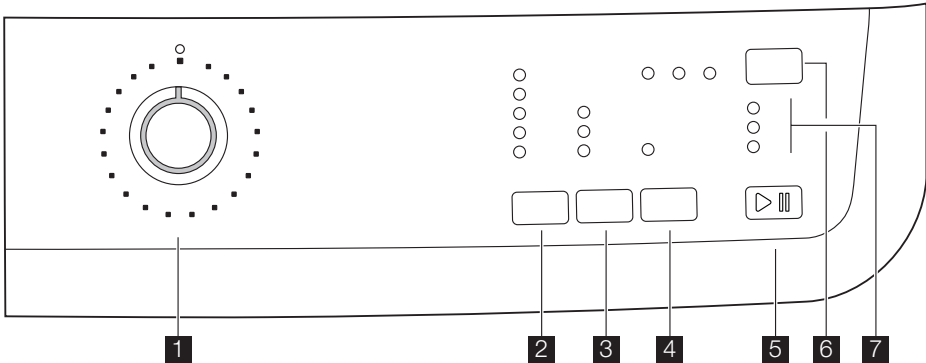

- 1 PROGRAMME selector dial**
- 2 SPIN reduction button**
- 3 OPTIONS button**
- 4 EXTRA RINSE button**
- 5 START/PAUSE button**
- 6 DELAY START button**
- 7 Pilot Lights**

Programme Selector Dial

It allows you to switch the appliance on/off and/or to select a programme.

Spin Reduction

By pressing this button you can change the spin speed of the selected programme.

Night Cycle

By selecting this function the machine will not drain the water of the last rinse and all spinning phases will be suppressed, so as not to wrinkle the laundry. This washing cycle is very quiet and it can be selected at night or in times with a more economical power rate. On some programmes the rinses will be performed with more water. Before opening the door it will be necessary to empty out the

water. To empty out the water, please read the paragraph «At the end of the programme».

Rinse hold

By selecting this function the water of the last rinse is not emptied out to prevent the fabrics from creasing. Before opening the door it will be necessary to empty out the water. To empty out the water, please read the paragraph «At the end of the programme».

Prewash

By selecting this option the machine performs a prewash cycle before the main wash phase. The washing time will be prolonged. This option is recommended for heavily soiled laundry.

Daily

By pressing this button the washing duration will be reduced. To be used for lightly soiled laundry.

Super Quick

Short cycle for lightly soiled items or for laundry which needs only freshening up. We recommend you to reduce the fabrics loading.

Extra Rinse

This appliance is designed to save energy. If it necessary to rinse the laundry using an extra quantity of water (extra rinse), select this option. Some additional rinses will be performed. This option is recommended for people who are allergic to detergents, and in areas where the water is very soft.

Delay Start

The start of the programme can be delayed by 2, 4 or 8 hours by means of this button.

Start Pause

This button allows you to start or to interrupt the selected programme.

Indicator pilot lights

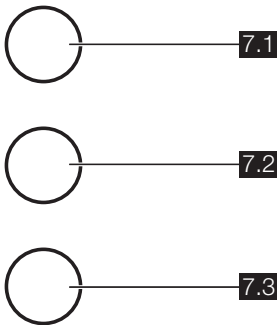

After having pressed the button **5** , the WASHING pilot light (7.1) illuminates. When the pilot light 7.1 comes on this means that the machine is operating.

When the programme has finished the END CYCLE pilot light (7.3) comes on.

The DOOR pilot light (7.2) illuminates when the programme starts and indicates if the door can be opened:

- light on: the door cannot be opened. The machine in working or has stopped with water left in the tub.
- light off: the door can be opened. The programme is finished or the water has been emptied out.
- light flashing: the door is opening.

Table of symbols

Selector dial symbols:

| | |
|--|-----------------------------------|
| | Cotton |
| | Economy (Energy saving programme) |
| | Cold wash |
| | Synthetic |
| | Delicate |
| | Wool/Handwash |
| | Rinse |
| | Drain |
| | Spin |
| | Mini |

| | |
|--|----------------|
| | Night Cycle |
| | Rinse Hold |
| | Spin reduction |
| | Prewash |
| | Daily |
| | Super Quick |
| | Options |
| | Extra Rinse |
| | Delay Start |
| | Washing |
| | Door locked |
| | End |

Push buttons and pilot lights:

First use

- i** • Ensure that the electrical and water connections comply with the installation instructions.
- Remove the polystyrene block and any material from the drum.
- Pour 2 liters of water into the main wash compartment  of the detergent drawer in order to activate the

ECO valve. Then run a cotton cycle at the highest temperature without any laundry in the machine, to remove any manufacturing residue from the drum and tub. Pour 1/2 a measure of detergent into the main wash compartment and start the machine.

Daily use

Load the laundry

Open the door by carefully pulling the door handle outwards. Place the laundry in the drum, one item at a time, shaking them out as much as possible. Close the door.

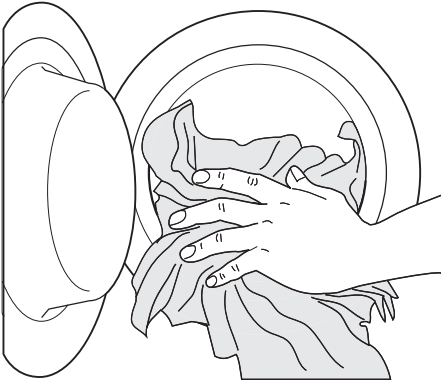

Measure out the detergent and the fabric softener

Pull out the dispenser drawer until it stops. Measure out the amount of detergent required, pour it into the main wash compartment  or in the appropriate compartment if the selected programme/option it requires (see more details in «Detergent dispenser drawer»).

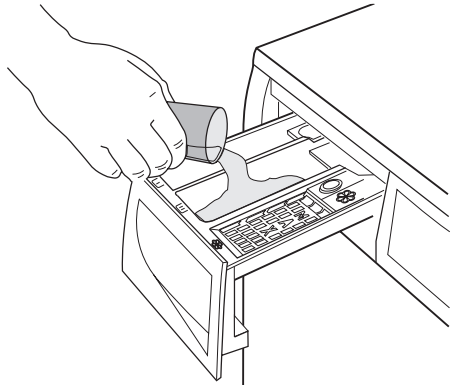

If required, pour fabric softener into the compartment marked  (the amount used must not exceed the «MAX» mark in the drawer). Close the drawer gently.

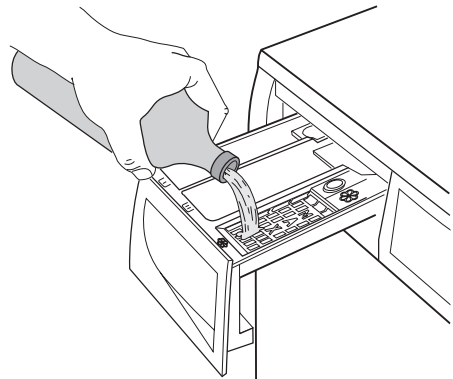

Select the required programme by turning the programme selector dial (1)

Turn the programme selector dial to the required programme. The washing machine

will automatically select the maximum spin value provided for the programme you have chosen. You can change this value by pressing the corresponding button. The **green** pilot light of the button **5** starts to flash. The selector dial can be turned either clockwise or counterclockwise. Turn to position « **O** » to reset programme/ Switching the machine off.

At the end of the programme the selector dial must be turned to position O, to switch the machine off.

 **Caution!** If you turn the programme selector dial to another programme when the machine is working, the **red** pilot light of button **5** will blink 3 times to indicate a wrong selection. The machine will not perform the new selected programme.

Reduce the spin speed by pressing button 2

By selecting a programme, the appliance proposes automatically the maximum spin speed provided for that programme. Press button **2** repeatedly to change the spin speed, if you want your laundry to be spun at a different speed. The relevant light illuminates.

Select the available options by pressing buttons 2, 3 and 4

Depending on the programme, different functions can be combined. These must be selected after choosing the desired programme and before starting the programme. When these buttons are pressed, the corresponding pilot lights illuminate. When they are pressed again, the pilot lights go out. If an incorrect option is selected, the integrated **red** pilot light of the button **5** flashes 3 times.

 For the compatibility among the washing programmes and the options see chapter «Washing Programmes».

Select the Delay Start by pressing button 6

Before you start the programme, if you wish to delay the start, press the button **6** repeatedly, to select the desired delay. The relevant light illuminates.

You must select this option after you have set the programme and before you start the programme.

You can cancel or modify the delay time at any moment, before you press button **5**. Selecting the delayed start:

1. Select the programme and the required options.
2. Select the delay start by pressing the button **6**.
3. Press button **5**:
 - the machine starts its hourly countdown.
 - The programme will start after the selected delay has expired.

Canceling the delayed start after having started the programme:

1. Set the washing machine to PAUSE by pressing button **5**.
2. Press button **6** once, the light relevant to the selected delay goes off
3. Press button **5** again to start the programme.

The Delay Start **can not** be selected with **DRAIN** programme.

Important! The selected delay can be changed only after selecting the washing programme again.

The door will be locked throughout the delay time. If you need to open the door, you must set the machine to PAUSE (by pressing the button **5**) and then wait a few minutes. After you have closed the door, press the button **5** again.

Start the programme by pressing button 5

To start the selected programme, press the button **5**, the corresponding green pilot light stops blinking. The pilot lights **7.1** and **7.2** illuminate to indicate that the appliance starts operating and the door is locked.

To interrupt a programme which is running, press the button **5**; the corresponding green pilot light starts blinking.

To restart the programme from the point at which it was interrupted, press the button **5** again. If you have chosen a delayed start, the machine will begin the countdown. If an incorrect option is selected, the **red** pilot light of the button **5** blinks for 3 times.

Altering an option or a running programme

It is possible to change some options before the programme carries them out.

Before you make any change, you must PAUSE the appliance by pressing the button **5**.

Changing a running programme is possible only by resetting it. Turn the programme selector dial to **O** and then to the new programme position. Start the new programme by pressing the button **5** again. The washing water in the tub will be not emptied out.

Interrupting a programme

Press the button **5** to interrupt a programme which is running, the corresponding green pilot light starts blinking.

Press the button again to **restart** the programme.

Cancelling a programme

Turn the selector dial to **O** to cancel a programme which is running.

You can select now a new programme.

Opening the door

After the programme has started (or during the delay time) the door is locked, if you need to open it, set first the machine to PAUSE by pressing the button **5**. After a few minutes the light **7.2** goes out and it is possible to open the door.

If this light remains lit and the door is locked, this means that the machine is already heating or that the water level is too high. In any case, do not try to force the door!

If you cannot open the door but you need to open it you have to switch the machine off by

turning the selector dial to **O**. After a few minutes the door can be opened (**pay attention to the water level and temperature!**).

After closing the door, it is necessary to select the programme and options again and to press button **5**.

At the end of the programme

The machine stops automatically. The pilot light of button **5**, the pilot lights **7.1** and **7.2** go off. The light **7.3** illuminates.

If a programme or an option that ends with water left in the tub has been selected, the pilot light **7.2** remains on and the door is locked to indicate that the water must be emptied out before opening the door.

Follow the below instructions to empty out the water:

1. Turn the programme selector dial to **O**.
2. Select the draining or spinning programme.
3. Reduce the spin speed if needed, by pressing the relevant button.
4. Press button **5**.

At the end of the programme, the pilot light **7.2** goes off to indicate that the door can be now opened. Turn the programme selector dial to **O** to switch the machine off.

Remove the laundry from the drum and carefully check that the drum is empty. If you do not intend to carry out another wash, close the water tap. Leave the door open to prevent the formation of mildew and unpleasant smells.

i Stand by : once the programme has finished after a few minutes the energy saving system is enabled with the pilot lights

switched on. By pressing any button the appliance will come out of the energy saving status.

Helpful hints and tips

Sorting out the laundry

Follow the wash code symbols on each garment label and the manufacturer's washing instructions. Sort the laundry as follows: whites, coloureds, synthetics, delicates, woollens.

Before loading the laundry

Never wash whites and coloureds together. Whites may lose their «whiteness» in the wash.

New coloured items may run in the first wash; they should therefore be washed separately the first time.

Button up pillowcases, close zip fasteners, hooks and poppers. Tie any belts or long tapes.

Remove persistent stains before washing. Rub particularly soiled areas with a special detergent or detergent paste.

Treat curtains with special care. Remove hooks or tie them up in a bag or net.

Removing stains

Stubborn stains may not be removed by just water and detergent. It is therefore advisable to treat them prior to washing.

Blood: treat fresh stains with cold water. For dried stains, soak overnight in water with a special detergent then rub in the soap and water.

Oil based paint: moisten with benzine stain remover, lay the garment on a soft cloth and dab the stain; treat several times.

Dried grease stains: moisten with turpentine, lay the garment on a soft surface and dab the stain with the fingertips and a cotton cloth.

Rust: oxalic acid dissolved in hot water or a rust removing product used cold. Be careful with rust stains which are not recent since the cellulose structure will already have been damaged and the fabric tends to hole.

Mould stains: treat with bleach, rinse well (whites and fast coloureds only).

Grass: soap lightly and treat with bleach (whites and fast coloureds only).

Ball point pen and glue: moisten with acetone¹⁾, lay the garment on a soft cloth and dab the stain.

Lipstick: moisten with acetone as above, then treat stains with methylated spirits. Treat any residual marks with bleach.

Red wine: soak in water and detergent, rinse and treat with acetic or citric acid, then rinse. Treat any residual marks with bleach.

Ink: depending on the type of ink, moisten the fabric first with acetone¹⁾, then with acetic acid; treat any residual marks on white fabrics with bleach and then rinse thoroughly.

Tar stains: first treat with stain remover, methylated spirits or benzine, then rub with detergent paste.

Detergents and additives

Good washing results also depend on the choice of detergent and use of the correct

quantities to avoid waste and protect the environment.

Although biodegradable, detergents contain substances which, in large quantities, can upset the delicate balance of nature.

The choice of detergent will depend on the type of fabric (delicates, woollens, cottons, etc.), the colour, washing temperature and degree of soiling.

All commonly available washing machine detergents may be used in this appliance:

- powder detergents for all types of fabric
- powder detergents for delicate fabrics (60°C max) and woollens
- liquid detergents, preferably for low temperature wash programmes (60°C max) for all types of fabric, or special for woollens only.

The detergent and any additives must be placed in the appropriate compartments of the dispenser drawer before starting the wash programme.

If using liquid detergents, a programme **without** prewash must be selected.

Your appliance incorporates a recirculation system which allows an optimal use of the concentrated detergent.

Follow the product manufacturer's recommendations on quantities to use and do **not exceed the «MAX» mark in the detergent dispenser drawer**.

Quantity of detergent to be used

The type and quantity of detergent will depend on the type of fabric, load size, degree of soiling and hardness of the water used. Follow the product manufacturers' instructions on quantities to use.

Use less detergent if:



















- you are washing a small load
- the laundry is lightly soiled
- large amounts of foam form during washing.

















Degrees of water hardness





Water hardness is classified in so-called "degrees" of hardness. Information on hardness of the water in your area can be obtained from the relevant water supply company, or from your local authority. If the water hardness degree is medium or high we suggest you to add a water softener following always the manufacturer's instructions. When the

degree of hardness is soft, readjust the quantity of the detergent.

Washing programmes

| Programme Maximum and Minimum Temperature Cycle Description Maximum Spin Speed Maximum Fabrics Load Type of Laundry | Options | Detergent Compartment |
|---|---|---|
| COTTONS  95°-60° Main wash - Rinses Long spin at maximum spin speed (800/1000/1200 rpm depending on a model) Max. load 6 kg - Red. load 3 kg For white and fast coloured cottons (heavily and normally soiled items). | SPIN NIGHT CYCLE RINSE HOLD PREWASH DAILY SUPER QUICK ¹⁾ EXTRA RINSE |  ²⁾   |
| COTTONS ECONOMY   60° Main wash - Rinses Long spin at maximum spin speed (800/1000/1200 rpm depending on a model) Max. load 6 kg For white and fast coloured cotton (normally soiled items) This programme can be selected for slightly or normally soiled cotton items. The temperature will decrease and the washing time will be extended. This allows to obtain a good washing efficiency so saving energy. | SPIN NIGHT CYCLE RINSE HOLD PREWASH EXTRA RINSE |  ²⁾   |
| COTTONS ECONOMY   40° Main wash - Rinses Long spin at maximum spin speed (800/1000/1200 rpm depending on a model) Max. load 6 kg For coloured cotton (lightly soiled items). This programme can be selected for slightly or normally soiled cotton items. The temperature will decrease and the washing time will be extended. This allows to obtain a good washing efficiency so saving energy. | SPIN NIGHT CYCLE RINSE HOLD PREWASH EXTRA RINSE |  ²⁾   |
| COTTONS  40°- COLD Main wash - Rinses Long spin at maximum spin speed (800/1000/1200 rpm depending on a model) Max. load 6 kg - Red. load 3 kg For coloured cottons (lightly soiled items). | SPIN NIGHT CYCLE RINSE HOLD PREWASH DAILY SUPER QUICK ¹⁾ EXTRA RINSE |  ²⁾   |

| Programme Maximum and Minimum Temperature Cycle Description Maximum Spin Speed Maximum Fabrics Load Type of Laundry | Options | Detergent Compartment |
|--|--|---|
| SYNTHETICS  60°- COLD Main wash - Rinses Maximum spin speed 900 rpm or 800 rpm - depending on a model Max. load 3 kg - Red. load 1,5 kg Synthetic or mixed fabrics: underwear, coloured garments, non-shrink shirts, blouses. | SPIN NIGHT CYCLE RINSE HOLD PREWASH DAILY SUPER QUICK ¹⁾ EXTRA RINSE |  ²⁾   |
| DELICATES  40°-30° Main wash - Rinses Maximum spin speed 700 rpm Max. load 3 kg- Red. load kg 1,5 Delicate fabrics: acrylics, viscose, polyester. | SPIN (only for model EWF 86110W) NIGHT CYCLE RINSE HOLD PREWASH DAILY SUPER QUICK ¹⁾ EXTRA RINSE |  ²⁾   |
| HANDWASH/WOOL     40° - COLD Main wash - Rinses Maximum spin speed 800/900/1000 rpm - depending on a model) Max. load 2 kg Washing programme for machine washable wool as well as for hand washable woollens and delicate fabrics with «hand washing» care symbol. Note : A single or bulky item may cause imbalance. If the appliance doesn't perform the final spin phase, add more items, redistribute the load manually and then select the spinning programme. | SPIN NIGHT CYCLE RINSE HOLD |   |
| RINSE  Rinses Long spin at maximum spin speed (800/1000/1200 rpm depending on a model) Max. load 6 kg With this programme it is possible to rinse and spin cotton garments which have been washed by hand. To intensify the rinsing action, select the option EXTRA RINSE. The appliance will add some additional rinses. | SPIN NIGHT CYCLE RINSE HOLD EXTRA RINSE |  |
| DRAIN  Draining of water Max. load 6 kg For emptying out the water of the last rinse in programmes with the Night Cycle and Rinse Hold option selected. | | |

| Programme Maximum and Minimum Temperature Cycle Description Maximum Spin Speed Maximum Fabrics Load Type of Laundry | Options | Detergent Compartment |
|---|----------------------------------|---|
| SPIN  Drain and long spin Long spin at maximum spin speed (800/1000/1200 rpm depending on a model) Max. load 6 kg Separate spin for hand washed garments and after programmes with the Rinse Hold and Night Cycle option selected. You can choose the spin speed by pressing the relevant button to adapt it to the fabrics to be spun. | SPIN | |
| MINI  30° Main wash - Rinses - Short spin Maximum spin speed 700 rpm Max. load 3 kg Ideal for laundry which is lightly soiled or which only needs freshening up. | SPIN (only for model EWF 86110W) |  |
|  = OFF For cancelling the programme which is running or to switch the machine off . | | |

- 1) If you select the Super Quick option by pressing button **3** , we recommend that you reduce the maximum load as indicated. (Red. load = reduced load). Full loading is possible however with somewhat reduced cleaning results.
 2) If using liquid detergent, a programme without PREWASH must be selected.

Care and cleaning

 **Warning!** You must disconnect the appliance from the electricity supply, before you can carry out any cleaning or maintenance work.

Descaling

The water we use normally contains lime. It is a good idea to periodically use a water softening powder in the machine. Do this separately from any laundry washing, and according to the softening powder manufacturer's instructions. This will help to prevent the formation of lime deposits.

After each wash

Leave the door open for a while. This helps to prevent mould and stagnant smells forming inside the appliance. Keeping the door open after a wash will also help to preserve the door seal.

Maintenance wash

With the use of low temperature washes it is possible to get a build up of residues inside the drum.

We recommend that a maintenance wash be performed on a regular basis.

To run a maintenance wash:

- The drum should be empty of laundry.
- Select the hottest cotton wash programme.
- Use a normal measure of detergent, must be a powder with biological properties.

External cleaning

Clean the exterior cabinet of the appliance with soap and water only, and then dry thoroughly.

Important! Do not use methylated spirits, solvents or similar products to clean the cabinet.

Cleaning the dispenser drawer

The detergent dispenser drawer should be cleaned regularly.

1. Remove the detergent dispenser drawer by pulling it firmly. Remove any traces of accumulated powder. To aid cleaning, the top part of the additive compartment should be removed.

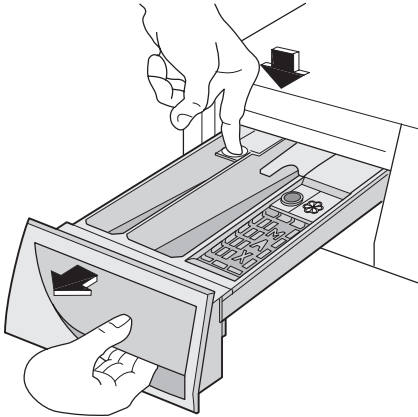

2. Remove the conditioner insert from the appropriate compartment.

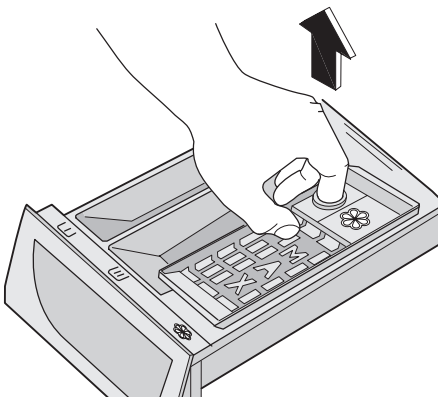

3. Clean all parts with water.
4. Put the conditioner insert in as far as it will go, so that it is firmly in place
5. Clean all parts of the machine, especially the nozzles in the top of the washing-in chamber, with a brush.

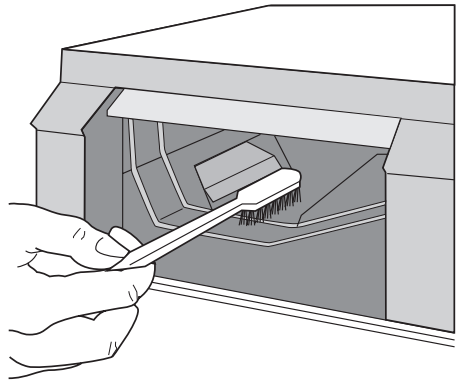

6. Insert the detergent dispenser drawer in the guide rails and push it in.

Washing drum

Rust deposits in the drum may occur due to rusting foreign bodies in the washing or tap water containing iron.

Important! Do not clean the drum with acidic descaling agents, scouring agents containing chlorine or iron or steel wool.

1. Remove any rust deposits on the drum with a cleaning agent for stainless steel.
2. Run a washing cycle without any washing to clean off any cleaning agent residues. Programme: Short Cotton Programme at maximum temperature and add approx. 1/4 measuring cup of detergent.

Door seal

Check from time to time the door seal and eliminate eventual possible objects that could be trapped in the fold.

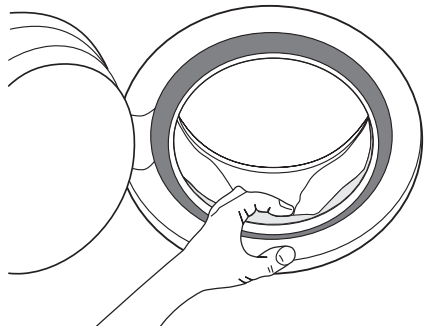

Drain pump

The pump should be inspected regularly and particularly if:

- the machine does not empty and/or spin
- the machine makes an unusual noise during draining due to objects such as safety pins, coins etc. blocking the pump.

Proceed as follows:

1. Disconnect the appliance.
2. If necessary wait until the water has cooled down.
3. Open the pump door.

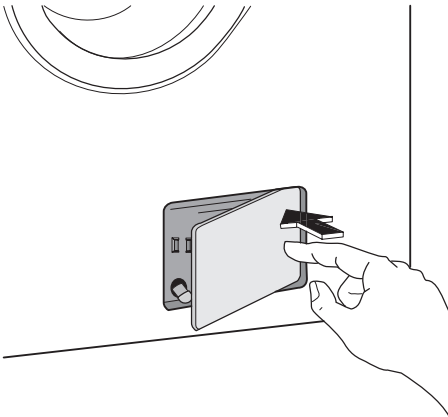

4. Place a container close to the pump to collect any spillage.
5. Release the emergency emptying hose, place it in the container and remove its cap cover.

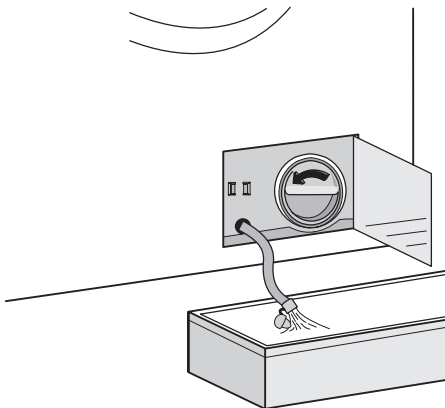

6. When no more water comes out, unscrew the pump and remove it. Always

keep a rag nearby to dry up spillage of water when removing the pump.

7. Remove any objects from the pump impeller by rotating it.

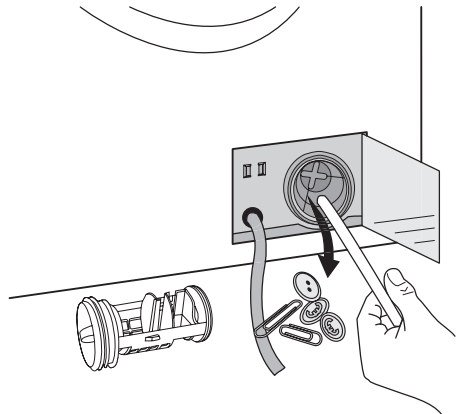

8. Refit the cap on the emergency emptying hose and place the latter back in its seat.
9. Screw the pump fully in.
10. Close the pump door.

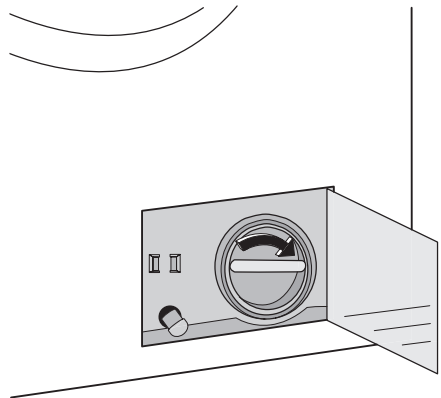

Warning!

When the appliance is in use and depending on the programme selected there can be hot water in the pump. Never remove the pump cover during a wash cycle, always wait until the appliance has finished the cycle, and is empty. When replacing the cover, ensure it is securely retightened so as to stop leaks and young children being able to remove it.

Cleaning the water inlet filters

If you notice that the machine is taking longer to fill, check that the filter in the water inlet hose is not blocked.

1. Turn off the water tap.
2. Unscrew the water inlet hose.
3. Clean the filter in the hose using a hard bristle brush.

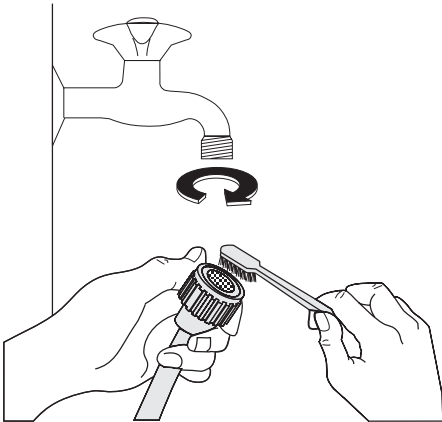

4. Screw the hose back onto the tap.
5. Unscrew the hose from the machine. Keep a rug nearby because some water may flow.
6. Clean the filter in the valve with a stiff brush or with the piece of cloth.

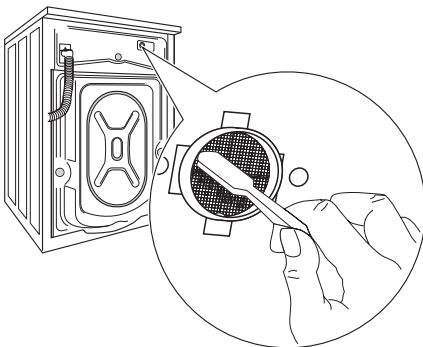

7. Screw the hose back to the machine and make sure the connection is tight.
8. Turn on the water tap.

What to do if...

Certain problems are due to lack of simple

maintenance or oversights which can be

Emergency emptying out

If the water is not discharged, proceed as follows to empty out the machine:

1. pull out the plug from the power socket;
2. close the water tap;
3. if necessary, wait until the water has cooled down;
4. open the pump door;
5. place a bowl on the floor and place the end of the emergency emptying hose into the bowl. Remove its cap. The water should drain by gravity into the bowl. When the bowl is full, put the cap back on the hose. Empty the bowl. Repeat the procedure until water stops flowing out;
6. clean the pump if necessary as previously described;
7. replace the emergency emptying hose in its seat after having plugged it;
8. screw the pump again and close the door.

Frost precautions

If the machine is installed in a place where the temperature could drop below 0°C, proceed as follows:

1. close the water tap and unscrew the water inlet hose from the tap;
2. place the end of the emergency emptying hose and that of the inlet hose in a bowl placed on the floor and let water drain out;
3. screw the water inlet hose back on and reposition the emergency emptying hose after having put the cap on again.

By doing this, any water remaining in the machine is removed, avoiding ice forming and consequently damage to the appliance.

When you use the machine again, make sure that the ambient temperature is above 0°C.

Important! Every time you drain the water through the emergency emptying hose you must pour 2 litres of water into the main wash compartment of the detergent drawer and then run the drain programme. This will activate the **ECO Valve** device avoiding that part of the detergent remains unused at next washing.

solved easily without calling out an engineer. Before contacting your local Service Centre, please carry out the checks listed below. During machine operation it is possible that the **red** pilot light of button **5** blinks to indicate that the machine is not working.

Once the problem has been eliminated, press the button **5** to restart the programme. If after all checks, the problem persists, contact your local Service Centre.

| Problem | Possible cause/Solution |
|---|--|
| The washing machine does not start: | <p>The door has not been closed (the button 5 red light blinks).</p> <ul style="list-style-type: none"> • Close the door firmly. <p>The plug is not properly inserted in the power socket.</p> <ul style="list-style-type: none"> • Insert the plug into the power socket. <p>There is no power at the socket.</p> <ul style="list-style-type: none"> • Please check your domestic electrical installation. <p>The main fuse has blown.</p> <ul style="list-style-type: none"> • Replace the fuse. <p>The programme selector dial is not correctly positioned and the button 5 has not been pressed.</p> <ul style="list-style-type: none"> • Please turn the selector dial and press the button 5 again. <p>The delay start has been selected.</p> <ul style="list-style-type: none"> • If the laundry are to be washed immediately, cancel the delay start. |
| The machine does not fill: | <p>The water tap is closed (the button 5 red light blinks).</p> <ul style="list-style-type: none"> • Open the water tap. <p>The inlet hose is squashed or kinked(the button 5 red light blinks).</p> <ul style="list-style-type: none"> • Check the inlet hose connection. <p>The filter in the inlet hose or the inlet valve filter are blocked (the button 5 red light blinks).</p> <ul style="list-style-type: none"> • Clean the water inlet filters (See "Cleaning the water inlet filters" for more details). <p>The door is not properly closed (the button 5 red light blinks).</p> <ul style="list-style-type: none"> • Close the door firmly. |
| The machine fills then empties immediately: | <p>The end of the drain hose is too low.</p> <ul style="list-style-type: none"> • Refer to relevant paragraph in «water drainage» section. |
| The machine does not empty and/or does not spin: | <p>The drain hose is squashed or kinked (the button 5 red light blinks).</p> <ul style="list-style-type: none"> • Check the drain hose connection. <p>The drain filter is clogged (the button 5 red light blinks).</p> <ul style="list-style-type: none"> • Clean the drain filter. <p>An option or a programme that ends with the water still in the tub or a that eliminates all the spinning phases has been selected.</p> <ul style="list-style-type: none"> • Select the draining or spinning programme. <p>The laundry is not evenly distributed in the drum.</p> <ul style="list-style-type: none"> • Redistribute the laundry. |
| There is water on the floor: | <p>Too much detergent or unsuitable detergent (creates too much foam) has been used.</p> <ul style="list-style-type: none"> • Reduce the detergent quantity or use another one. <p>Check whether there are any leaks from one of the inlet hose fittings. It is not always easy to see this as the water runs down the hose; check to see if it is damp.</p> <ul style="list-style-type: none"> • Check the water inlet hose connection. <p>The drain or inlet hose is damaged.</p> <ul style="list-style-type: none"> • Replace it with a new one. <p>The cap on the emergency emptying hose has not been replaced or the filter has not been properly screwed in after cleaning action.</p> <ul style="list-style-type: none"> • Refit the cap on the emergency emptying hose or screw the filter fully in. |

| Problem | Possible cause/Solution |
|---|---|
| Unsatisfactory washing results: | <p>Too little detergent or unsuitable detergent has been used.</p> <ul style="list-style-type: none"> • Increase the detergent quantity or use another one. <p>Stubborn stains have not been treated prior to washing.</p> <ul style="list-style-type: none"> • Use commercial products to treat the stubborn stains. <p>The correct temperature was not selected.</p> <ul style="list-style-type: none"> • Check if you have selected the correct temperature. <p>Excessive laundry load.</p> <ul style="list-style-type: none"> • Reduce the laundry load. |
| The door will not open: | <p>The programme is still running.</p> <ul style="list-style-type: none"> • Wait the end of washing cycle. <p>The door lock has not been released.</p> <ul style="list-style-type: none"> • Wait until the light 7.2 has gone out. <p>There is water in the drum.</p> <ul style="list-style-type: none"> • Select drain or spin programme to empty out the water. |
| The machine vibrates is noisy: | <p>The transit bolts and packing have not been removed.</p> <ul style="list-style-type: none"> • Check the correct installation of the appliance. <p>The support feet have not been adjusted</p> <ul style="list-style-type: none"> • Check the correct levelling of the appliance. <p>The laundry is not evenly distributed in the drum.</p> <ul style="list-style-type: none"> • Redistribute the laundry. <p>Maybe there is very little laundry in the drum.</p> <ul style="list-style-type: none"> • Load more laundry. |
| Spinning starts late or the machine does not spin: | <p>The electronic unbalance detection device has cut in because the laundry is not evenly distributed in the drum. The laundry is redistributed by reverse rotation of the drum. This may happen several times before the unbalance disappears and normal spinning can resume. If, after 10 minutes, the laundry is still not evenly distributed in the drum, the machine will not spin. In this case, redistribute the load manually and select the spin programme.</p> <ul style="list-style-type: none"> • Redistribute the laundry. <p>The load is too small.</p> <ul style="list-style-type: none"> • Add more items, redistribute the load manually and then select the spinning programme. |
| The machine makes an unusual noise: | <p>The machine is fitted with a type of motor which makes an unusual noise compared with other traditional motors. This new motor ensures a softer start and more even distribution of the laundry in the drum when spinning, as well as increased stability of the machine.</p> |
| No water is visible in the drum: | <p>Machines based on modern technology operate very economically using very little water without affecting performance.</p> |

If you are unable to identify or solve the problem, contact our service centre. Before telephoning, make a note of the model, serial number and purchase date of your machine: the Service Centre will require this information.

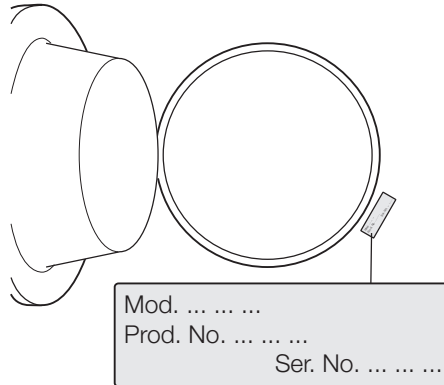

Technical data

| | | |
|---|---|---|
| Dimensions | Width Height Depth Depth (Overall dimensions) | 60 cm 85 cm 60 cm 63 cm |
| Electrical connection Voltage - Overall power - Fuse | Information on the electrical connection is given on the rating plate, on the inner edge of the appliance door. | |
| Water supply pressure | Minimum Maximum | 0,05 MPa 0,8 MPa |
| Maximum Load | Cotton | 6 kg |
| Spin Speed | Maximum | 800 rpm (EWF 86110W) 1000 rpm (EWF106110W) 1200 rpm (EWF 126110W) |

Consumption values

| Programme | Energy consumption (KWh) | Water consumption (litres) | Programme duration (Minutes) |
|--------------------------|--------------------------|----------------------------|------------------------------|
| White Cottons 95° | 2 | 61 | 135 |
| Cottons 60° | 1.3 | 58 | 125 |
| Cotton ECO 60° 1) | 1.02 | 46 | 150 |
| Cottons 40° | 0.7 | 58 | 120 |
| Synthetics 40° | 0.5 | 50 | 80 |
| Delicates 40° | 0.55 | 60 | 65 |
| Wool/ Handwash 30° | 0.25 | 53 | 55 |

1) «Cottons Eco» at 60°C with a load of 6 kg is the reference programme for the data entered in the energy label, in compliance with EEC 92/75 standards.

i The consumption data shown on this chart is to be considered purely indicative, as it may vary depending on the quantity and type of laundry, on the inlet water temperature and on the ambient temperature.

Installation

Unpacking

All transit bolts and packing must be removed before using the appliance. You are advised to keep all transit devices so that they can be refitted if the machine ever has to be transported again.

1. After removing all the packaging, carefully lay machine on it's back to remove the polystyrene base from the bottom.

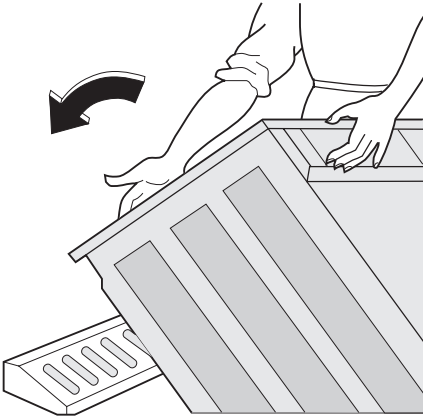

2. Remove the power supply cable and the draining and inlet hose from the hose holders on the rear of the appliance.

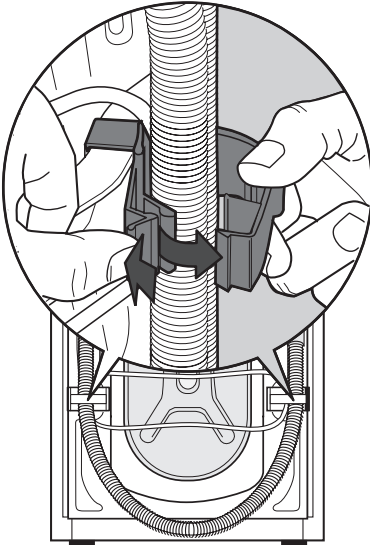

3. Unscrew the three bolts.

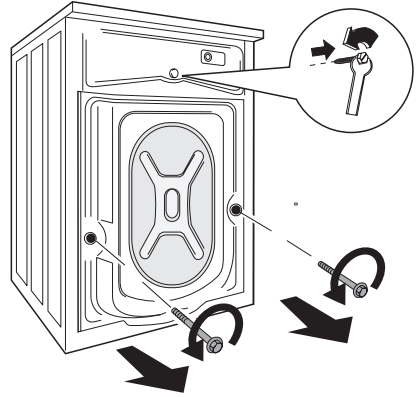

4. Slide out the relevant plastic spacers.

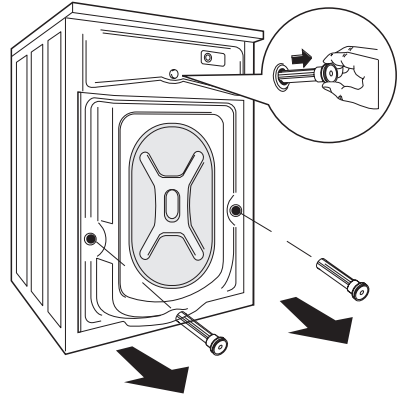

5. Fill the smaller upper hole and the two large ones with the corresponding plastic plug caps supplied in the bag containing the instruction booklet.

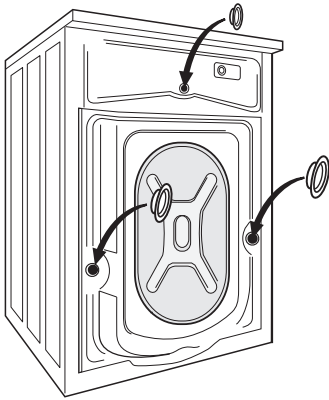

Positioning

Install the machine on a flat hard floor. Make sure that air circulation around the machine is not impeded by carpets, rugs etc. Check that the machine does not touch the wall or other kitchen units. Level the washing machine by raising or lowering the feet. The feet may be tight to adjust as they incorporate a self locking nut, but the machine **MUST** be level and stable. If necessary, check the setting with a spirit level. Any necessary adjustment can be made with a spanner. Accurate levelling prevents vibration, noise and displacement of the machine during operation.

Caution! Never place cardboard, wood or similar materials under the machine to compensate for any unevenness in the floor.

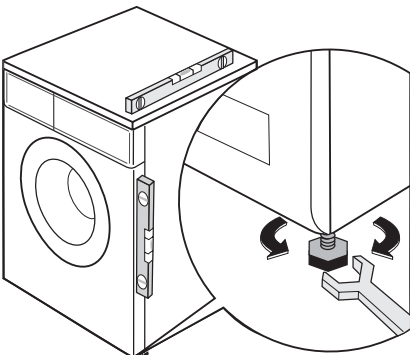

Water inlet

Warning! This appliance must be connected to a cold water supply.

1. Connect the water inlet hose supplied with the machine to a tap with a 3/4" thread. Always use the hose supplied with the appliance.

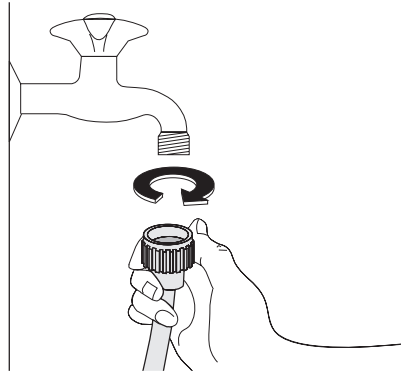

Important! Do not use the hose from your previous machine to connect to the water supply.

2. The other end of the inlet hose which connects to the machine can be turned as showed in the picture. Do not place the inlet hose downwards. Angle the hose to the left or right depending on the position of your water tap.

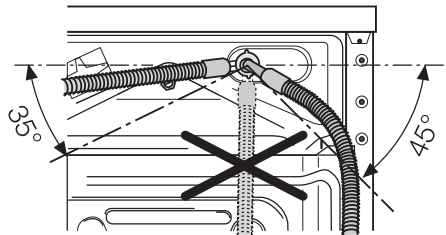

3. Set the hose correctly by loosening the ring nut. After positioning the inlet hose, be sure to tighten the ring nut again to prevent leaks. The inlet hose must not be lengthened. If it is too short and you do not wish to move the

tap, you will have to purchase a new, longer hose specially designed for this type of use.

Important! Before connecting up the machine to new pipework or to pipework that has not been used for some time, run off a reasonable amount of water to flush out any debris that may have collected in the pipes.

Water drainage

The end of the drain hose can be positioned in three ways.

- **Hooked over the edge of a sink** using the plastic hose guide supplied with the machine. In this case, make sure the end cannot come unhooked when the machine is emptying. This could be done by tying it to the tap with a piece of string or attaching it to the wall.

- **In a sink drain pipe branch.** This branch must be above the trap so that the bend is at least 60 cm above the ground.
- **Directly into a drain pipe** at a height of not less than 60 cm and not more than 90 cm. The end of the drain hose must always be ventilated, i.e. the inside diameter of the drain pipe must be larger than the outside diameter of the drain hose. The drain hose must not be kinked.

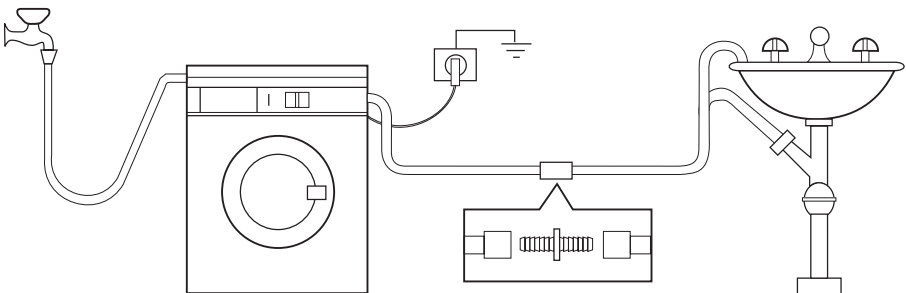
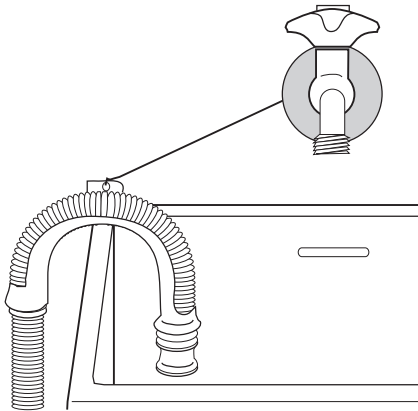

The drain hose may be extended to a maximum of 4 metres. An additional drain hose and joining piece is available from your local Service Centre.

Electrical connection

Information on the electrical connection is given on the rating plate on the inner edge of the appliance door.

Check that your domestic electrical installation can take the maximum load required, also taking into account any other appliances in use.

 **Connect the machine to an earthed socket.**

 **The manufacturer does not accept any responsibility for damage or**

injury through failure to comply with the above safety precaution.

 **The power supply cable must be easily accessible after installing the machine.**

 **Should the appliance power supply cable need to be replaced, this must be carried out by a Service Centre.**

Environment concerns

The symbol  on the product or on its packaging indicates that this product may not be treated as household waste. Instead it should be taken to the appropriate collection point for the recycling of electrical and electronic equipment. By ensuring this product is disposed of correctly, you will help prevent potential negative consequences for the environment and human health, which could otherwise be caused by inappropriate waste handling of this product. For more detailed information about recycling of this product, please contact your local council, your household waste disposal service or the shop where you purchased the product.

Packaging materials

The materials marked with the symbol  are recyclable.

>PE<=polyethylene

>PS<=polystyrene

>PP<=polypropylene

This means that they can be recycled by disposing of them properly in appropriate collection containers.

Ecological hints

To save water, energy and to help protect the environment, we recommend that you follow these tips:

- Normally soiled laundry may be washed without prewashing in order to save detergent, water and time (the environment is protected too!).
- The machine works more economically if it is fully loaded.
- With adequate pre-treatment, stains and limited soiling can be removed; the laundry can then be washed at a lower temperature.
- Measure out detergent according to the water hardness, the degree of soiling and the quantity of laundry being washed.

www.electrolux.com