



ELECTRIC RANGE

Use & Care Guide

For questions about features, operation/performance,
parts accessories or service, call:
1-800-253-1301

or visit our website at...
www.whirlpool.com

Table of Contents 2

MODELS **RF350PXH** **RF350BXG**
 RF354BXG **RF344BXH**

TABLE OF CONTENTS

RANGE SAFETY	3
The Anti-Tip Bracket	3
PARTS AND FEATURES	6
COOKTOP USE	7
Control Knobs	7
Ceramic Glass	7
Coil Elements and Burner Bowls	8
Lift-up Cooktop	8
Home Canning	8
Cookware	9
OVEN USE	10
Electronic Oven Control	10
Display	10
Indicator Lights.....	10
Start/Enter and Off/Cancel.....	10
Control Lock.....	10
Oven Temperature Control	11
Aluminum Foil.....	11
Positioning Racks and Bakeware	11
Bakeware.....	12
Oven Vent.....	12
Baking and Roasting	12
Broiling and Custom Broiling	13
RANGE CARE	14
Self-Cleaning Cycle.....	14
Cleaning.....	15
Storage Drawer	16
Oven Light	17
Oven Door	17
TROUBLESHOOTING	18
ASSISTANCE OR SERVICE	19
WARRANTY	20

RANGE SAFETY

Your safety and the safety of others are very important.

We have provided many important safety messages in this manual and on your appliance. Always read and obey all safety messages.



This is the safety alert symbol.

This symbol alerts you to potential hazards that can kill or hurt you and others.

All safety messages will follow the safety alert symbol and either the word "DANGER" or "WARNING." These words mean:

⚠ DANGER

You can be killed or seriously injured if you don't immediately follow instructions.

⚠ WARNING

You can be killed or seriously injured if you don't follow instructions.

All safety messages will tell you what the potential hazard is, tell you how to reduce the chance of injury, and tell you what can happen if the instructions are not followed.

The Anti-Tip Bracket

The range will not tip during normal use. However, the range can tip if you apply too much force or weight to the open door without the anti-tip bracket fastened down properly.



⚠ WARNING

Tip Over Hazard

A child or adult can tip the range and be killed.

Connect anti-tip bracket to rear range foot.

Reconnect the anti-tip bracket, if the range is moved.

See the installation instructions for details.

Failure to follow these instructions can result in death or serious burns to children and adults.

Anti-Tip Bracket

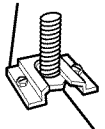

Range Foot

Making sure the anti-tip bracket is installed:

- Slide range forward.
- Look for the anti-tip bracket securely attached to floor.
- Slide range back so rear range foot is under anti-tip bracket.

IMPORTANT SAFETY INSTRUCTIONS

WARNING : To reduce the risk of fire, electrical shock, injury to persons, or damage when using the range, follow basic precautions, including the following:

- **WARNING :** TO REDUCE THE RISK OF TIPPING OF THE RANGE, THE RANGE MUST BE SECURED BY PROPERLY INSTALLED ANTI-TIP DEVICES. TO CHECK IF THE DEVICES ARE INSTALLED PROPERLY, SLIDE RANGE FORWARD, LOOK FOR ANTI-TIP BRACKET SECURELY ATTACHED TO FLOOR, AND SLIDE RANGE BACK SO REAR RANGE FOOT IS UNDER ANTI-TIP BRACKET.
- **CAUTION :** Do not store items of interest to children in cabinets above a range or on the back-guard of a range – children climbing on the range to reach items could be seriously injured.
- Proper Installation – Be sure the range is properly installed and grounded by a qualified technician.
- Never Use the Range for Warming or Heating the Room.
- Do Not Leave Children Alone – Children should not be left alone or unattended in area where the range is in use. They should never be allowed to sit or stand on any part of the range.
- Wear Proper Apparel – Loose-fitting or hanging garments should never be worn while using the range.
- User Servicing – Do not repair or replace any part of the range unless specifically recommended in the manual. All other servicing should be referred to a qualified technician.
- Storage in or on the Range – Flammable materials should not be stored in an oven or near surface units.
- Do Not Use Water on Grease Fires – Smother fire or flame or use dry chemical or foam-type extinguisher.
- Use Only Dry Potholders – Moist or damp potholders on hot surfaces may result in burns from steam. Do not let potholder touch hot heating elements. Do not use a towel or other bulky cloth.
- DO NOT TOUCH SURFACE UNITS OR AREAS NEAR UNITS – Surface units may be hot even though they are dark in color. Areas near surface units may become hot enough to cause burns. During and after use, do not touch, or let clothing or other flammable materials contact surface units or areas near units until they have had sufficient time to cool. Among those areas are the cooktop and surfaces facing the cooktop.
- Use Proper Pan Size – The range is equipped with one or more surface units of different size. Select utensils having flat bottoms large enough to cover the surface unit heating element. The use of under-sized utensils will expose a portion of the heating element to direct contact and may result in ignition of clothing. Proper relationship of utensil to burner will also improve efficiency.
- Never Leave Surface Units Unattended at High Heat Settings – Boilover causes smoking and greasy spillovers that may ignite.
- Make Sure Reflector Pans or Drip Bowls Are in Place – Absence of these pans or bowls during cooking may subject wiring or components underneath to damage.
- Protective Liners – Do not use aluminum foil to line surface unit drip bowls or oven bottoms, except as suggested in the manual. Improper installation of these liners may result in a risk of electric shock, or fire.
- Glazed Cooking Utensils – Only certain types of glass, glass/ceramic, ceramic, earthenware, or other glazed utensils are suitable for range-top service without breaking due to the sudden change in temperature.
- Utensil Handles Should Be Turned Inward and Not Extend Over Adjacent Surface Units – To reduce the risk of burns, ignition of flammable materials, and spillage due to unintentional contact with the utensil, the handle of a utensil should be positioned so that it is turned inward, and does not extend over adjacent surface units.
- Do Not Soak Removable Heating Elements – Heating elements should never be immersed in water.
- Do Not Cook on Broken Cooktop – If cooktop should break, cleaning solutions and spillovers may penetrate the broken cooktop and create a risk of electric shock. Contact a qualified technician immediately.
- Clean Cooktop With Caution – If a wet sponge or cloth is used to wipe spills on a hot cooking area, be careful to avoid steam burn. Some cleaners can produce noxious fumes if applied to a hot surface.
- Use Care When Opening Door – Let hot air or steam escape before removing or replacing food.
- Do Not Heat Unopened Food Containers – Build-up of pressure may cause container to burst and result in injury.

SAVE THESE INSTRUCTIONS

IMPORTANT SAFETY INSTRUCTIONS

- Keep Oven Vent Ducts Unobstructed.
- Placement of Oven Racks – Always place oven racks in desired location while oven is cool. If rack must be moved while oven is hot, do not let potholder contact hot heating element in oven.
- DO NOT TOUCH HEATING ELEMENTS OR INTERIOR SURFACES OF OVEN – Heating elements may be hot even though they are dark in color. Interior surfaces of an oven become hot enough to cause burns. During and after use, do not touch, or let clothing or other flammable materials contact heating elements or interior surfaces of oven until they have had sufficient time to cool. Other surfaces of the appliance may become hot enough to cause burns – among these surfaces are oven vent openings and surfaces near these openings, oven doors, and windows of oven doors.

For self-cleaning ranges –

- Do Not Clean Door Gasket – The door gasket is essential for a good seal. Care should be taken not to rub, damage, or move the gasket.
- Do Not Use Oven Cleaners – No commercial oven cleaner or oven liner protective coating of any kind should be used in or around any part of the oven.
- Clean Only Parts Listed in Manual.
- Before Self-Cleaning the Oven – Remove broiler pan and other utensils.

For units with ventilating hood –

- Clean Ventilating Hoods Frequently – Grease should not be allowed to accumulate on hood or filter.
- When flaming foods under the hood, turn the fan on.

SAVE THESE INSTRUCTIONS

The California Safe Drinking Water and Toxic Enforcement Act requires the Governor of California to publish a list of substances known to the State of California to cause cancer, birth defects, or other reproductive harm, and requires businesses to warn of potential exposure to such substances.

WARNING: This product contains a chemical known to the State of California to cause cancer, birth defects, or other reproductive harm.

This appliance can cause low-level exposure to some of the substances listed, including benzene, formaldehyde, carbon monoxide, and toluene.

PARTS AND FEATURES

This manual covers several different models. The range you have purchased may have some or all of the parts and features listed. The location and appearance of the features shown here may not match your model.

Control Panel

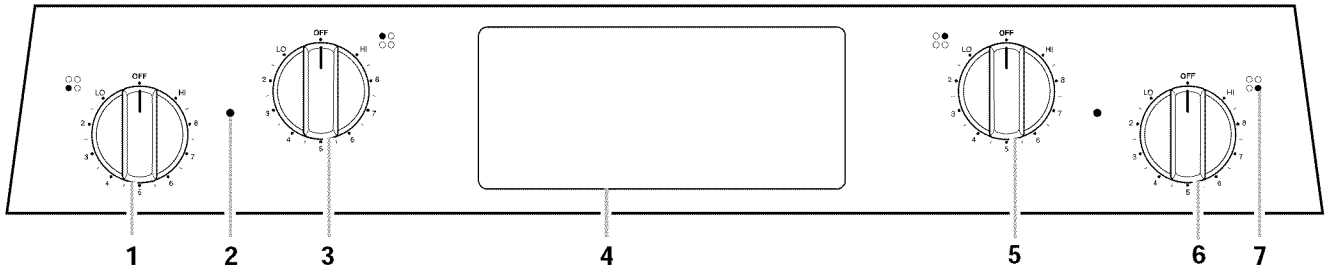

- 1. Left Front Control Knob
- 2. Surface Heating Indicator Light

- 3. Left Rear Control Knob
- 4. Electronic Oven Control

- 5. Right Rear Control Knob
- 6. Right Front Control Knob
- 7. Surface Cooking Area or Element Marker

Range

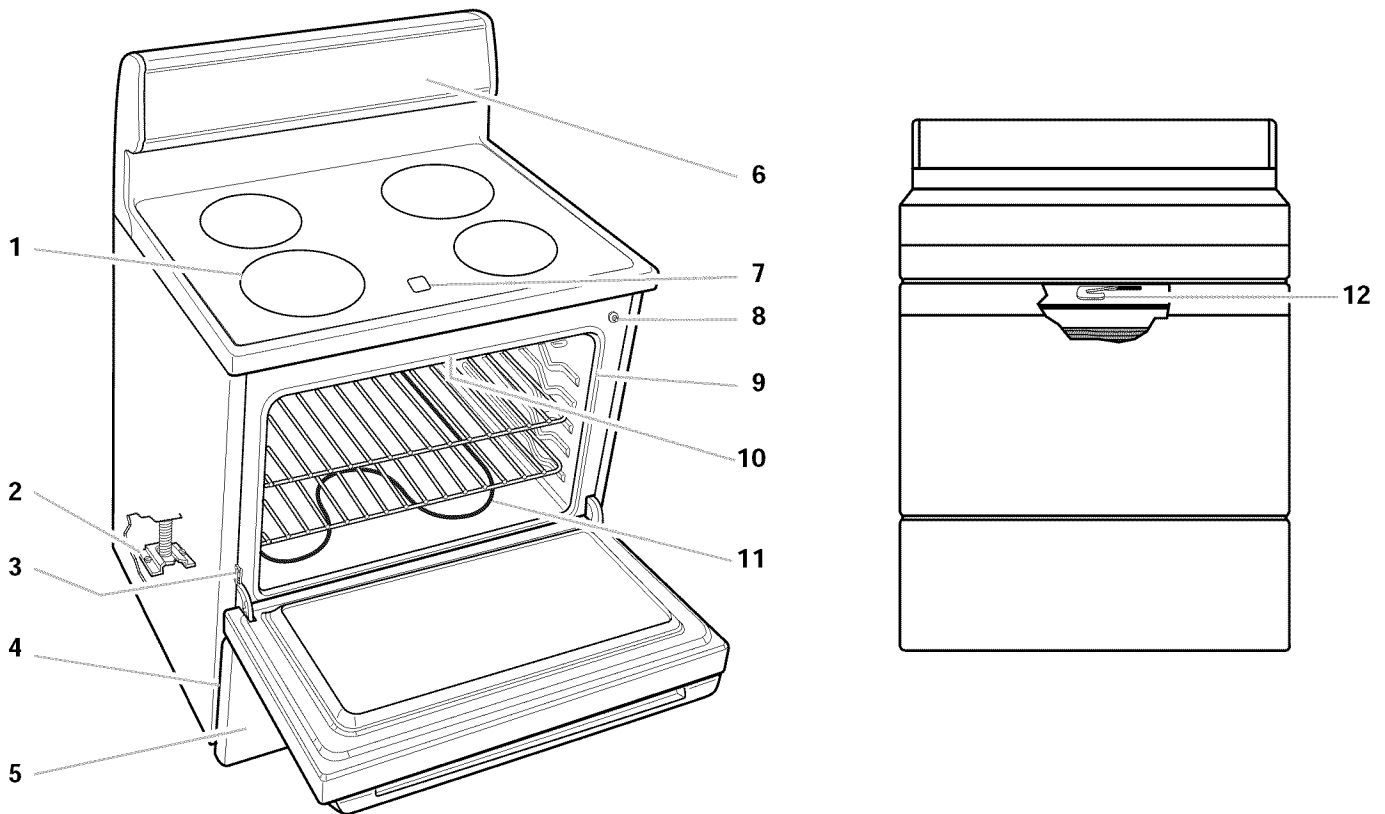

- 1. Surface Cooking Area or Element
- 2. Anti-Tip Bracket
- 3. Door Stop Clip
- 4. Model and Serial Number Plate (behind left side of storage drawer)
- 5. Storage Drawer
- 6. Control Panel

- 7. Hot Surface Indicator Light (on ceramic glass models)
- 8. Automatic Oven Light Switch (on some models)
- 9. Gasket
- 10. Broil Element (not shown)
- 11. Bake Element

- 12. Self-Clean Latch (on some models)
- Parts and Features not shown** (on some models)
- CLEANTOP® Ceramic Glass
 - Oven Door Window
 - Oven Light
 - Manual Oven Light Switch

COOKTOP USE

Control Knobs

⚠ WARNING



Fire Hazard

**Turn off all controls when done cooking.
Failure to do so can result in death or fire.**

The control knobs can be set anywhere between HI and LO. Push in and turn to setting. Use the following chart as a guide when setting heat levels.

SETTING	RECOMMENDED USE
HI	<ul style="list-style-type: none"> Start food cooking. Bring liquid to a boil.
6-8 [MED- HI]	<ul style="list-style-type: none"> Hold a rapid boil. Quickly brown or sear food.
5 [MED]	<ul style="list-style-type: none"> Maintain a slow boil. Fry or sauté foods. Cook soups, sauces and gravies.
2-4 [MED- LO]	<ul style="list-style-type: none"> Stew or steam food. Simmer.
LO	<ul style="list-style-type: none"> Keep food warm. Melt chocolate or butter.
ACCUSIMMER™ setting (on some models)	<ul style="list-style-type: none"> Precise simmer control.
Dual Watt Element (on some ceramic glass models)	<ul style="list-style-type: none"> Home canning. Large diameter cookware. Large quantities of food.
Keep Warm Element (on some ceramic glass models)	<ul style="list-style-type: none"> Keep cooked foods warm.

Ceramic Glass

(on some models)

The surface cooking area will glow red when an element is on. It will cycle on and off, at all settings, to maintain the selected heat level. Wiping off the cooktop before and after each use will help keep it free from stains and provide the most even heating. For more information, see "Cleaning" section.

- Do not cook foods directly on the cooktop.
- Do not allow objects that could melt, like plastic or aluminum foil, to touch a hot cooktop.
- Clean up sugary spills and soils as soon as hot surface indicator light goes off. If not wiped up while warm, surface pitting can occur.
- Do not cook popcorn in prepackaged aluminum containers on the cooktop. It could leave aluminum marks that cannot be removed completely.
- Do not store jars or cans above the cooktop. Dropping a heavy or hard object on the cooktop could crack it.
- Do not use the cooktop as a cutting board.
- Use cookware about the same size as the surface cooking area. Cookware should not extend more than 1 in. (2.5 cm) outside the area.

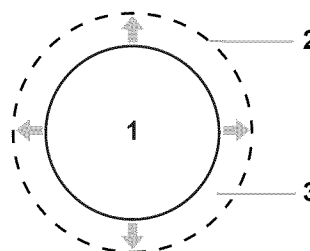

1. Surface Cooking Area
2. Cookware/Canner
3. 1" (2.5 cm) Maximum Overhang

- Make sure the bottoms of pots and pans are clean and dry before using them. Residue and water can leave deposits when heated.
- Lift pots and pans on and off the cooktop. Sliding pots, pans and skillets that have aluminum or copper bases could leave permanent scratches and marks on the cooktop.
- Use flat-bottomed cookware for best heat conduction and energy efficiency. Cookware with rounded, warped, ribbed or dented bottoms could cause uneven heating and poor cooking results.
- Cookware designed with slightly indented bottoms or small expansion channels can be used.
- Determine flatness by placing the straight edge of a ruler across the bottom of the cookware. While rotating the ruler, no space or light should be visible between it and the cookware.

Hot Surface Indicator Light (under ceramic glass)

The hot surface indicator light will glow as long as any surface cooking area is too hot to touch, even after the surface cooking area(s) are turned off.



REMEMBER: When range is in use or during the Self-Cleaning cycle, the entire cooktop area may become hot.

Coil Elements and Burner Bowls

(on some models)

Coil elements should be level for optimal cooking results. Burner bowls, when clean, reflect heat back to the cookware. They also help catch spills.

Cookware should not extend more than 1 in. (2.5 cm) over the coil element. If cookware is uneven or too large, it can produce excess heat causing the burner bowl to change color. For more information, see the "Cleaning" section.

Before removing or replacing coil elements and burner bowls, make sure they are cool and the control knobs are off.

To Remove :

1. Push in the edge of coil element toward the receptacle. Then lift it just enough to clear the burner bowl.

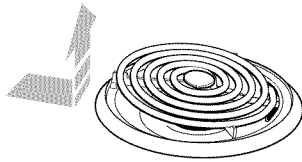

2. Pull the coil element straight away from the receptacle.

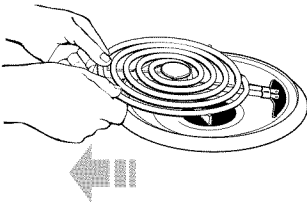

3. Lift out the burner bowl.

To Replace :

1. Line up openings in the burner bowl with the coil element receptacle.

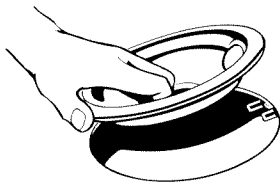

2. Holding the coil element as level as possible, carefully push coil element terminal into the receptacle.
3. When the terminal is pushed into the receptacle as far as it will go, push down the edge of the coil element opposite the receptacle.

Lift-up Cooktop

(on some models)

The lift-up cooktop provides easy access underneath it for cleaning. Be careful not to drop it because damage could occur to the finish and the cooktop frame. For more information, see the "Cleaning" section.

To Lift :

1. Lift the front of the cooktop at both front corners until the support rods lock into place.

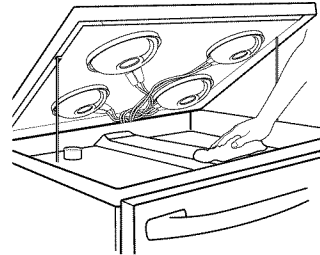

To Replace :

1. Lift the cooktop from both sides while pressing the support rods back to unlock them.
2. Slowly lower the cooktop into place.

Home Canning

When canning for long periods, alternate the use of surface cooking areas, elements or surface burners between batches. This allows time for the surrounding areas to cool.

- Center the canner on the grate or largest surface cooking area or element. Canners should not extend more than 1 in. (2.5 cm) outside the cooking area.
- Do not place canner on two surface cooking areas, elements or surface burners at the same time.
- On ceramic glass models, only use flat-bottomed canners.
- On coil element models, the installation of a Canning Unit Kit is recommended. If not installed, the life of the coil element will be shortened. See "Assistance or Service" for ordering instructions.
- For more information, contact your local U.S. Government Agricultural Department Extension Office. In Canada, contact Agriculture Canada. Companies who manufacture home canning products can also offer assistance.

Cookware

IMPORTANT: Never leave empty cookware on a hot surface cooking area, element or surface burner.

Ideal cookware should have a flat bottom, straight sides, a well-fitting lid and the material should be of medium-to-heavy thickness.

Cookware material is a factor in how quickly and evenly heat is transferred, ultimately affecting cooking results. A non-stick finish has the same characteristics as its base material. For example, aluminum cookware with a non-stick finish will take on the properties of aluminum.

Use the following chart as a guide for cookware material characteristics.

COOKWARE	CHARACTERISTICS
*Aluminum	<ul style="list-style-type: none">■ Heats quickly and evenly.■ Suitable for all types of cooking.■ Medium or heavy thickness is best for most cooking tasks.
Cast iron	<ul style="list-style-type: none">■ Heats slowly and evenly.■ Good for browning and frying.■ Maintains heat for slow cooking.■ Rough surfaces may scratch cooktop.
Ceramic or Ceramic glass	<ul style="list-style-type: none">■ Follow manufacturer's instructions.■ Rough surfaces may scratch cooktop.■ Heats slowly, but unevenly.■ Best results on low to medium heat settings.
*Copper	<ul style="list-style-type: none">■ Heats very quickly and evenly.
Earthenware	<ul style="list-style-type: none">■ Follow manufacturer's instructions.■ Use on low heat settings.
Porcelain enamel-on-steel or cast iron	<ul style="list-style-type: none">■ See stainless steel or cast iron.
Stainless steel	<ul style="list-style-type: none">■ Heats quickly, but unevenly.■ A core or base of aluminum or copper on stainless steel provides even heating.

*Aluminum and copper may be used as core or base in cookware and can leave permanent marks on the cooktop or grates.

OVEN USE

Electronic Oven Control

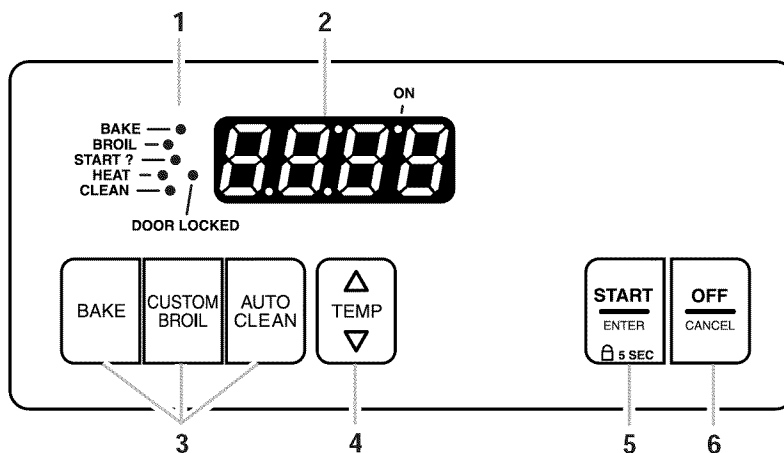

1. Indicator Lights

2. Display

3. Oven Selectors

4. Temperature

5. Start/Enter

6. Off/Cancel

Display

After installing the appliance according to the Installation Instructions and connecting the power supply, "PF" will appear on the display. Press OFF/CANCEL to clear "PF".

If "PF" appears again, a power failure has occurred. Press OFF/CANCEL to clear display.

- When using the oven, the display shows preheat time and temperature setting.
- The ON light will come on when the oven is on.
- When not using the oven, the display is blank.

Control Lock

The Control Lock shuts down the control panel to prevent unintended use of the oven. Do not use when the oven is in use or a control has been set.

To Lock Control :

Press and hold START/ENTER for 5 seconds.

A tone will sound. "Loc" will appear on the display and the START? indicator light will come on. Both will go off in 5 seconds.

When the control is locked and any pad is pressed, "Loc" will appear on the display and the START? indicator light will come on. Both will go off in 5 seconds.

To Unlock Control :

Press and hold START/ENTER for 5 seconds.

During those 5 seconds "Loc" will appear on the display and the START? indicator light will come on. A tone will sound, then both will go off.

Indicator Lights

The BAKE, BROIL and CLEAN indicator lights will come on when that setting is selected. For example, when the BAKE pad is pressed and during the bake cycle the BAKE indicator light will come on.

The HEAT indicator light will come on and go off periodically as the oven elements cycle during baking, broiling or self-cleaning.

The DOOR LOCKED indicator light will come on when the oven door is locked.

Start/Enter and Off/Cancel

START/ENTER begins any function. If START/ENTER is not pressed within 5 seconds, the "START?" indicator light will flash. If START/ENTER is not pressed within 5 minutes, the function will be canceled.

OFF/CANCEL stops any function except for the Control Lock.

Oven Temperature Control

IMPORTANT: Do not use a thermometer to measure oven temperature because opening the oven door and element or burner cycling may give incorrect readings.

The oven provides accurate temperatures, however, it may cook differently than your previous oven, so the temperature calibration can be adjusted.

A minus sign means the oven will be cooler by the displayed amount. No sign means the oven will be warmer by the displayed amount. Use the following chart as a guide.

ADJUSTMENT °F	COOKS FOOD
10°F (5°C)	...a little more
20°F (10°C)	...moderately more
30°F (15°C)	...much more
-10°F (-5°C)	...a little less
-20°F (-10°C)	...moderately less
-30°F (-15°C)	...much less

To Adjust Oven Temperature Calibration:

- Press and hold BAKE for 5 seconds.
The display will show the current oven temperature calibration, for example, "00", if not yet adjusted.



- Press TEMP (▲) or (▼) to change the temperature in 10°F (5°C) amounts. The adjustment can be set between -30°F (-15°C) and 30°F (15°C).

When decreasing, a minus sign (-) appears in front of the number. When increasing, nothing appears in front of the number.

- Press START/ENTER.

Aluminum Foil

IMPORTANT: Do not line the oven bottom with any type of foil, liners or cookware because permanent damage will occur to the oven bottom finish. On gas models, do not block the oven bottom vents.

- Do not cover entire rack with foil because air circulation and overall oven performance will decrease.
- To catch spills, place foil on rack below dish. Make sure foil is at least 1 in. (2.5 cm) larger than the dish and turn up at edges.

Positioning Racks and Bakeware

Racks

Position racks before turning the oven on. Do not move racks with bakeware on them. Make sure racks are level. Use the following graphic and chart as a guide to place racks for specific foods.

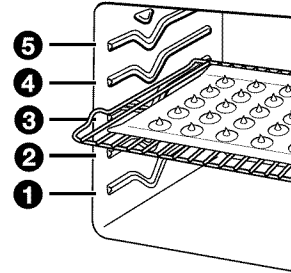

On ACCUBAKE® models, when baking two sheets of cookies at the same time, use rack positions 2 and 4. At about ¾ of the way through baking, switch sheets. Increase baking time if necessary.

FOOD	RACK POSITION(S)
Frozen pies, large roasts, turkeys, angel food cakes	1 or 2
Bundt cakes, most quick breads, yeast breads, casseroles, meats	2
Cookies, biscuits, muffins, cakes, non frozen pies	2 or 3

Bakeware

Hot air must be able to circulate around food to cook evenly, so allow 2 in. (5 cm) of space around bakeware and oven walls. Use the following chart as a guide.

BAKEWARE NUMBER	POSITION ON RACK
1	Center of rack.
2	Side by side or slightly staggered.
3 or 4	Opposite corners on each rack. Make sure bakeware is not directly over another.

Bakeware

The bakeware material affects cooking results. Follow manufacturer's recommendations and use the bakeware size recommended in the recipe. Use the following chart as a guide.

BAKEWARE/ RESULTS	RECOMMENDATIONS
Light colored aluminum <ul style="list-style-type: none"> Light golden crusts Even browning 	<ul style="list-style-type: none"> Use temperature and time recommended in recipe.
Dark aluminum and other bakeware with dark, dull and/or non-stick finish <ul style="list-style-type: none"> Brown, crisp crusts 	<ul style="list-style-type: none"> May reduce baking temperatures 25°F (15°C). Use suggested baking time. For pies, breads and casseroles, use temperature recommended in recipe. Place rack in center of oven.
Insulated cookie sheets or baking pans <ul style="list-style-type: none"> Little or no bottom browning 	<ul style="list-style-type: none"> Place in the bottom third of oven. May need to increase baking time.
Stainless steel <ul style="list-style-type: none"> Light, golden crusts Uneven browning 	<ul style="list-style-type: none"> May need to increase baking time.
Stoneware <ul style="list-style-type: none"> Crisp crusts 	<ul style="list-style-type: none"> Follow manufacturer's instructions.
Ovenproof glassware, ceramic glass or ceramic <ul style="list-style-type: none"> Brown, crisp crusts 	<ul style="list-style-type: none"> May reduce baking temperatures 25°F (15°C).

Oven Vent

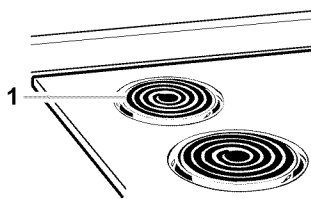

1. Oven Vent (coil element model)

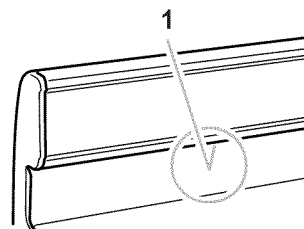

1. Oven Vent (ceramic glass model)

The oven vent releases hot air and moisture from the oven, and should not be blocked or covered. Doing so will cause poor air circulation, affecting cooking and cleaning results. Never set plastics, paper or other items that could melt or burn near the oven vent.

On coil element models, the element can be used when the oven is in use as long as the cookware does not extend more than 1 in. (2.5 cm) over the element.

On ceramic glass models, Cooktop Polishing Creme can be used to minimize soiling in the vent area. See "Assistance or Service" section to order.

To Minimize Soiling (ceramic glass models):

1. Use the Self-Cleaning cycle often, before the oven becomes too soiled.
2. Before Self-Cleaning, apply Cooktop Polishing Creme on the control panel directly above the vent area. On stainless steel models, do not allow creme to contact stainless steel.
3. Rub creme into surface with a damp paper towel or soft cloth. Continue rubbing until white film disappears.

Baking and Roasting

IMPORTANT: Never place food or cookware directly on the oven door or the oven bottom.

Before baking and roasting, position racks according to the "Positioning Racks and Bakeware" section. When roasting, it is not necessary to wait for the oven preheat conditioning time to end before putting food in unless recommended in the recipe.

To Bake or Roast:

1. Press **BAKE**.
Press **TEMP** (▲) or (▼) to set a temperature other than 350°F (175°C) in 5° amounts. The bake range can be set between 170°F and 500°F (75°C and 260°C).
2. Press **START/ENTER**.
The temperature can be changed after this step. **START/ENTER** does not need to be pressed again. The preheat time will not change if the temperature is reset before the countdown ends.
3. Press **OFF/CANCEL** when finished.

Preheating

After START/ENTER is pressed, the oven will enter a fixed preheat time based on the temperature selected.

The preheat time countdown will appear on the display unless the actual oven temperature is greater than 170°F (75°C).

When the preheat conditioning time ends, a tone will sound and the selected temperature will appear on the display.

Preheat temperatures are affected by varying factors such as room temperature and peak energy usage times. It is normal for the temperature showing on the display and the actual oven temperature to differ.

Waiting an additional ten minutes after the preheat conditioning time ends to put food in the oven is suggested when baking foods with leavening ingredients, such as yeast, baking powder, baking soda and eggs.

Broiling and Custom Broiling

Broiling uses direct radiant heat to cook food. Changing the temperature when Custom Broiling allows more precise control when cooking. The lower the temperature, the slower the cooking. Thicker cuts and unevenly shaped pieces of meat, fish and poultry may cook better at lower broiling temperatures.

- Use only the broiler pan and grid provided with the range. It is designed to drain juices and help prevent spatter and smoke.
- For proper draining, do not cover the grid with foil. The bottom of the pan may be lined with aluminum foil for easier cleaning.
- Trim excess fat to reduce spattering. Slit the remaining fat on the edges to prevent curling.
- Pull out oven rack to stop position before turning or removing food. Use tongs to turn food to avoid the loss of juices. Very thin cuts of fish, poultry or meat may not need to be turned.
- After broiling, remove the pan from the oven when removing the food. Drippings will bake on the pan if left in the heated oven, making cleaning more difficult.

Before broiling, position rack according to Broiling Chart. It is not necessary to preheat the oven before putting food in unless recommended in the recipe. Position food on grid in the broiler pan, then place it in the center of the oven rack. Close the door to the broil stop position to ensure proper broiling temperature.

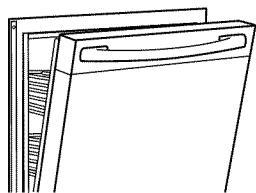

To Broil :

1. Press CUSTOM BROIL.
2. Press START/ENTER.
3. Press OFF/CANCEL when finished.

To Custom Broil :

1. Press CUSTOM BROIL.
2. Press TEMP (▼) or (▲) to change the temperature in 5° amounts. The broil range can be set between 300°F and 500°F (150°C and 260°C).
3. Press START/ENTER.
4. Press OFF/CANCEL when finished.

Broiling Chart

For best results, place food 3 in. (7 cm) or more from the broil element. Times are guidelines only and may need to be adjusted for individual foods and tastes. Recommended rack positions are numbered from the bottom (1) to the top (5). For diagram, see the "Positioning Racks and Bakeware" section.

FOOD	RACK POSITION	COOK TIME minutes	
		Side 1	Side 2
Steak			
1 in. (2.5 cm) thick medium rare	4	14-15	7-8
medium	4	15-16	8-9
well done	4	18-19	9-10
*Ground meat patties			
¾ in. (2 cm) thick well done	4	13-14	7-8
Pork chops			
1 in. (2.5 cm) thick	4	20-22	10-11
Ham slice, precooked			
½ in. (1.25 cm) thick	4	8-10	4-5
Frankfurters			
	4	5-7	3-4
Lamb chops			
1 in. (2.5 cm) thick	4	14-17	8-9
Chicken			
bone-in pieces	3	17-20	17-20
boneless breasts	4	11-16	11-16
Fish			
Fillet ¼- ½ in. (.6-1.25 cm) thick	4	8-10	4-5
Steaks ¾- 1 in. (2-2.5 cm) thick	4	16-18	8-9

* Place up to 9 patties, equally spaced, on broiler grid.

RANGE CARE

Self-Cleaning Cycle (on some models)

⚠ WARNING



Burn Hazard

Do not touch the oven during the Self-Cleaning cycle.

Keep children away from oven during Self-Cleaning cycle.

Do not use commercial oven cleaners in your oven.

Failure to follow these instructions can result in burns, or illness from inhaling dangerous fumes.

IMPORTANT: The health of some birds is extremely sensitive to the fumes given off during the Self-Cleaning cycle. Exposure to the fumes may result in death to certain birds. Always move birds to another closed and well ventilated room.

Self-clean the oven before it is heavily soiled. Heavy soil results in longer cleaning and more smoke.

Keep the kitchen well-ventilated during the Self-Cleaning cycle to help get rid of heat, odors, and smoke.

Do not block the oven vent during the Self-Cleaning cycle. Air must be able to move freely. See "Oven Vent" section.

Prepare Oven:

- Do not let water, cleaner, etc. enter slots on door frame. Use a dampened cloth to clean this area.
- Remove the broiler pan, grid, cookware and bakeware from the oven.
- Remove any foil from the oven because it may burn or melt, damaging the oven.
- Remove oven racks to keep them shiny and easy to slide. If leaving in, place them on rack positions 2, 3 or 4. For diagram, see "Positioning Racks and Bakeware". Racks will discolor and become harder to slide. See "Cleaning" for more information.

- Hand clean inside door edge and the 1½ in. (3.8 cm) area around the inside oven cavity frame, being careful not to move or bend the gasket. This area does not get hot enough during self-cleaning to remove soil.
- Wipe out any loose soil to reduce smoke and avoid damage. At high temperatures, foods react with porcelain. Staining, etching, pitting or faint white spots can result. This will not affect cooking performance.

Prepare Cooktop and Storage Drawer (on ranges):

- Remove plastic items from the cooktop because they may melt.
- Remove all items from the storage drawer.

How the Cycle Works

IMPORTANT: The heating and cooling of porcelain on steel in the oven may result in discoloring, loss of gloss, hairline cracks and popping sounds.

The Self-Cleaning cycle uses very high temperatures, burning soil to a powdery ash.

The oven is preset for a 3½ hour clean cycle, however the time can be changed. Suggested clean times are 2½ hours for light soil and between 3½ to 4½ hours for average to heavy soil.

Once the oven has completely cooled, remove ash with a damp cloth. **The oven light will not work during the Self-Cleaning cycle.**

Before self-cleaning, make sure the door is closed completely or it will not lock and the cycle will not begin.

To Self-Clean:

1. Press AUTO CLEAN.
Press TEMP (▲) or (▼) to set a clean time other than 3½ hours. It can be set between 2½ and 4½ hours.
2. Press START/ENTER.
The door will lock automatically after START/ENTER is pressed. It will not unlock until the oven cools to an appropriate temperature.
3. When the cycle is complete, "End" will appear on the display. Press any pad to clear the display.

To Stop Self-Clean (at any time):

1. Press OFF/CANCEL.
If the oven temperature is too high, "cool" will appear on the display. The door will remain locked until the oven has cooled to an appropriate temperature.



If and when the oven temperature is appropriately cool, "End" will appear on the display. Press any pad to clear the display.

Cleaning

IMPORTANT: Before cleaning, make sure all controls are off and the oven and cooktop are cool. Always follow label instructions on cleaning products.

Soap, water and a soft cloth or sponge are suggested first unless otherwise noted.

EXTERIOR PORCELAIN ENAMEL SURFACES (on some models)

Food spills containing acids, such as vinegar and tomato, should be cleaned as soon as the entire appliance is cool. These spills may affect the finish.

- Glass cleaner, mild liquid cleaner or non-abrasive scrubbing pad:
Gently clean around the model and serial number plate because scrubbing may remove numbers.

STAINLESS STEEL (on some models)

Do not use steel wool or soap-filled scouring pads.

Do not use Cooktop Polishing Creme or abrasive cleansers. Rub in direction of grain to avoid damaging.

- Stainless Steel Cleaner & Polish:
See "Assistance or Service" to order.
- Liquid detergent or all-purpose cleaner:
Rinse with clean water and dry with soft, lint-free cloth.
- Vinegar for hard water spots

CERAMIC GLASS (on some models)

Do not use steel wool, abrasive powder cleansers, chlorine bleach, rust remover or ammonia because damage may occur.

Always wipe with a clean, wet cloth or sponge and dry thoroughly to prevent streaking and staining.

Use Cooktop Polishing Creme regularly to help prevent scratches, pitting and abrasions and to condition the cooktop. See "Assistance or Service" to order.

A Cooktop Scraper is also recommended for certain soils. See "Assistance or Service" to order.

Light to moderate soil

- Paper towels or clean damp sponge:
Clean while the cooktop is still warm. You may want to wear oven mitts while doing so.

Sugary spills (jellies, candy, syrup)

- Cooktop Scraper:
Clean while the cooktop is still warm. You may want to wear oven mitts while doing so.
- Cooktop Polishing Creme and clean damp paper towel:
Clean as soon as cooktop has cooled down. Rub creme into surface with a damp paper towel or soft cloth. Continue rubbing until white film disappears.

Heavy soil, dark streaks, specks and discoloration

- Cooktop Polishing Creme or non-abrasive cleanser:
Rub product into soil with a damp paper towel or soft cloth. Continue rubbing until white film disappears.

Burned-on soil

- Cooktop Polishing Creme and Cooktop Scraper:
Rub creme into soil with damp paper towel. Hold scraper as flat as possible on surface and scrape. Repeat for stubborn spots. Polish entire cooktop with creme and paper towel.

Metal marks from aluminum and copper

- Cooktop Polishing Creme:
Clean as soon as cooktop has cooled down. Rub creme into surface with a damp paper towel or soft cloth. Continue rubbing until white film disappears. The marks will not totally disappear but after many cleanings become less noticeable.

Tiny scratches and abrasions

- Cooktop Polishing Creme:
Rub creme into surface with a damp paper towel or soft cloth. Continue rubbing until white film disappears. Scratches and abrasions do not affect cooking performance and after many cleanings become less noticeable.

CONTROL KNOBS

Do not use steel wool, abrasive cleansers or oven cleaner.

Do not soak.

When replacing knobs, make sure knobs are in the OFF position.

On some models, do not remove seals under knobs.

- Soap and water or dishwasher:
Pull knobs straight away from control panel to remove.

COIL ELEMENTS (on some models)

Do not clean or immerse in water. Soil will burn off when hot. For more information, see "Coil Elements and Burner Bowls".

- Damp cloth:
Make sure control knobs are off and elements are cool.

BURNER BOWLS (on some models)

- Solution of ½ cup (125 mL) ammonia to 1 gallon (3.75 L) water:
Soak for 20 minutes, then scrub with stainless steel wool pad.
- Oven cleaner:
Follow product label instructions.
- Mildly abrasive cleanser:
Scrub with wet scouring pad.

Porcelain enamel only, not chrome

- Dishwasher

SURFACE UNDER COOKTOP (on some models)

Do not remove the cooktop to avoid product damage.
For more information, see "Lift-up Cooktop" section.

- Steel wool pad

CONTROL PANEL

- Glass cleaner and soft cloth or sponge:
Apply glass cleaner to soft cloth or sponge, not directly on panel.

OVEN CAVITY

Food spills should be cleaned when oven cools. At high temperatures, foods react with porcelain and staining, etching, pitting or faint white spots can result.

Self-Cleaning models

- Self-Cleaning cycle:
See "Self-Cleaning Cycle" first.

Standard-Cleaning models

On some models, the oven door can be removed. See "Oven Door" first.

- Steel wool pad
- Oven cleaner:
Follow product label instructions. Do not let cleaner contact gasket, thermostat or exterior surfaces. Line the floor with newspaper.

OVEN DOOR GLASS (on some models)

- Glass cleaner and paper towels or non-abrasive plastic scrubbing pad

OVEN RACKS

- Self-Cleaning cycle:
See "Self-Cleaning Cycle" first. Racks will discolor and become harder to slide. After cleaning, a light coating of vegetable oil applied to the rack guides will help them slide.
- Steel wool pad

BROILER PAN AND GRID

Do not clean in the Self-Cleaning cycle.

- Mildly abrasive cleanser:
Scrub with wet scouring pad.
- Solution of ½ cup (125 mL) ammonia to 1 gallon (3.75 L) water:
Soak for 20 minutes, then scrub with scouring or steel wool pad.
- Oven cleaner:
Follow product label instructions.

Porcelain enamel only, not chrome

- Dishwasher

STORAGE DRAWER

Make sure drawer is cool and empty before cleaning.
For more information, see "Storage Drawer" section.

- Mild detergent

Storage Drawer

The storage drawer can be removed. Before removing, make sure drawer is cool and empty.

To Remove :

1. Pull drawer straight out to the first stop.
2. Lift up the back of the drawer and pull out.

To Replace :

1. Fit the ends of the drawer rails into the guides in the cavity.
2. Slide the drawer closed.

Oven Light

(on some models)

The oven light is a standard 40-watt appliance bulb. It will come on when the oven door is open. It will not work during the Self-Cleaning cycle. On some models, when the oven door is closed, press the manual oven light switch to turn on and off.

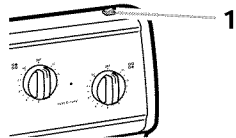

1. Manual Oven Light Switch (on some models)

Before replacing, make sure the oven and cooktop are cool and the control knobs are off.

To Replace:

1. Unplug range or disconnect power.
2. Turn the glass bulb cover in the back of the oven counterclockwise to remove.

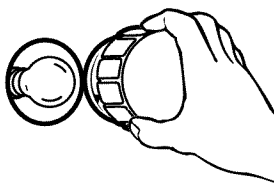

3. Turn bulb counterclockwise to remove from socket.
4. Replace bulb, then bulb cover by turning clockwise.
5. Plug in range or reconnect power.

Oven Door

For normal range use, it is not suggested to remove the oven door. However, if necessary, follow these instructions. The oven door is heavy.

Before Removing:

1. Use a putty knife or screwdriver and insert it at the bottom corner of the door stop clip.

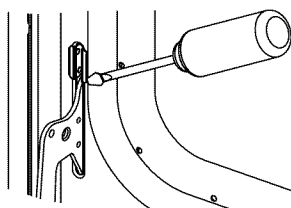

2. Pry door stop clip free and remove from front frame hinge slot. Take care not to scratch finish.
3. Repeat procedure for other door stop clip.

To Remove:

1. Open the oven door. Insert door removal pins, included with your range, into both hinge hangers. Do not remove the pins while the door is removed from the range.

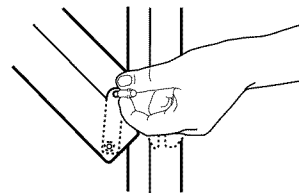

2. Carefully close the door until it rests against the door removal pins.
3. Grasp the door on the sides with your fingers on the front of the door and your thumbs on the inside surface.
4. Pull door straight up, then toward you. Hinge hangers will slide out of front frame hinge slot. Do not remove door removal pins until the door is replaced on the range.

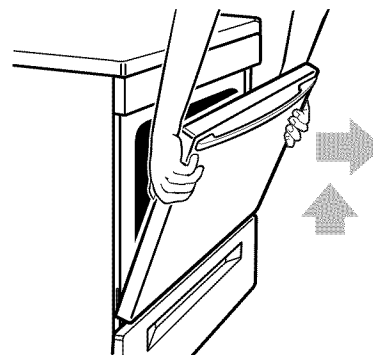

To Replace:

1. Grasp the door on the sides with your fingers on the front of the door and your thumbs on the inside surface.
2. Hold oven door so that the top edge of each hinge hanger is horizontal. Insert hinge hangers into the front frame hinge slots.
3. Tilt top of door toward range. Slide hinge hangers down onto front frame support pins. Make sure the hinge hangers are fully seated and engaged on the support pins.

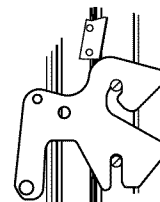

4. Insert the door stop clip with the angular surface at the top of the frame hinge slot, then push in the bottom of the clip until flanges are flush with the front frame.

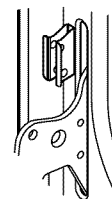

5. Open the door completely and remove the door removal pins. Save door removal pins for future use.
6. Close the door.

TROUBLESHOOTING

Try the solutions suggested here first in order to avoid the cost of an unnecessary service call.

Nothing will operate

- **Is the power supply cord unplugged?**
Plug into a grounded 3 prong outlet.
 - **Has a household fuse been blown or has the circuit breaker been tripped?**
Replace the fuse or reset the circuit.
-

Cooktop will not operate

- **Is the control knob set correctly?**
Push in knob before turning to a setting.
 - **On coil element models, is the element inserted properly?**
See "Coil Elements and Burner Bowls" section.
-

Excessive heat around cookware on cooktop

- **Is the cookware the proper size?**
Use cookware about the same size as the surface cooking area, element or surface burner. Cookware should not extend more than 1 in. (2.5 cm) outside the cooking area.
-

Oven will not operate

- **Is the electronic oven control set correctly?**
See "Electronic Oven Control" section.
 - **On some models, is the Control Lock set?**
See "Control Lock" section.
-

Oven temperature too high or too low

- **Does the oven temperature calibration need adjustment?**
See "Oven Temperature Control" section.
-

Display shows messages

- **Is the display showing "PF"?**
There has been a power failure. Press OFF/CANCEL to clear the display. On some models, reset the clock, if needed. See "Clock" section.
 - **Is the display showing "F" followed by a number?**
Press OFF/CANCEL to clear the display. If an "F" code reappears, call for service. See "Assistance or Service" section.
-

Self-Cleaning cycle will not operate

- **Is the oven door open?**
Close the oven door all the way.
 - **Has START/ENTER been pressed?**
Press START/ENTER.
 - **On some models, has a delay start been set?**
See "Timed Cooking" section.
-

Cooktop cooking results not what expected

- **Is the proper cookware being used?**
See "Cookware" section.
 - **Is the control knob set to the proper heat level?**
See "Control Knobs" section.
 - **Is the appliance level?**
Level the appliance. See the Installation Instructions.
 - **On coil element models, is the element inserted properly?**
See "Coil Elements and Burner Bowls" section.
-

Oven cooking results not what expected

- **Is the appliance level?**
Level the appliance. See the Installation Instructions.
 - **Is the proper temperature set?**
Double check the recipe in a reliable cookbook.
 - **Is the proper oven temperature calibration set?**
See "Oven Temperature Control" section.
 - **Was the oven preheated?**
See "Baking and Roasting" section.
 - **Is the proper bakeware being used?**
See "Bakeware" section.
 - **Are the racks positioned properly?**
See "Positioning Racks and Bakeware" section.
 - **Is there proper air circulation around bakeware?**
See "Positioning Racks and Bakeware" section.
 - **Is the batter evenly distributed in the pan?**
Check to make sure batter is level in the pan.
 - **Is the proper length of time being used?**
Adjust cooking time.
 - **Has the oven door been opened while cooking?**
Oven peeking releases oven heat and can result in longer cooking times.
 - **Are baked items too brown on the bottom?**
Move rack to higher position in the oven.
 - **Are pie crust edges browning early?**
Use aluminum foil to cover the edge of the crust.
-

ASSISTANCE OR SERVICE

Before calling for assistance or service, please check "Troubleshooting." It may save you the cost of a service call. If you still need help, follow the instructions below.

When calling, please know the purchase date and the complete model and serial number of your appliance. This information will help us to better respond to your request.

If you need replacement parts

If you need to order replacement parts, we recommend that you only use FSP® replacement parts. FSP® replacement parts will fit right and work right because they are made with the same precision used to build every new WHIRLPOOL® appliance.

To locate FSP® replacement parts in your area, call our Customer Interaction Center telephone number or your nearest Whirlpool Corporation designated service center.

In the U.S.A.

Call the Whirlpool Corporation Customer Interaction Center toll free: **1-800-253-1301**.

Our consultants provide assistance with:

- Features and specifications on our full line of appliances.
- Installation information.
- Use and maintenance procedures.
- Accessory and repair parts sales.
- Specialized customer assistance (Spanish speaking, hearing impaired, limited vision, etc.).
- Referrals to local dealers, repair parts distributors, and service companies. Whirlpool Corporation designated service technicians are trained to fulfill the product warranty and provide after-warranty service, anywhere in the United States.

To locate the Whirlpool Corporation designated service company in your area, you can also look in your telephone directory Yellow Pages.

For further assistance

If you need further assistance, you can write to Whirlpool Corporation with any questions or concerns at:

Whirlpool Brand Home Appliances
Customer Interaction Center
c/o Correspondence Dept.
MD 8020
553 Benson Road
Benton Harbor, MI 49022-2400

Please include a daytime phone number in your correspondence.

Accessories

To order accessories, call the Whirlpool Corporation Customer Interaction Center toll free at **1-800-253-1301** and follow the menu prompts. Or visit our website at www.whirlpool.com and click on "Buy Accessories Here".

Canning Unit Kit

(coil element models)
Order Part #242905.

Cooktop Polishing Creme

(ceramic glass models)
Order Part #4392916

Cooktop Scraper

(ceramic glass models)
Order Part #3183488

Stainless Steel Cleaner & Polish

(stainless steel models)
Order Part #4396095

WHIRLPOOL® COOKTOP, BUILT-IN OVEN AND RANGE WARRANTY

FULL ONE-YEAR WARRANTY

For one year from the date of purchase, when this appliance is operated and maintained according to instructions attached to or furnished with the product, Whirlpool Corporation will pay for FSP® replacement parts and repair labor to correct defects in materials or workmanship. Service must be provided by a Whirlpool Corporation designated service company.

FULL FIVE-YEAR WARRANTY

On ceramic glass ranges and ceramic glass cooktops, for five years from the date of purchase, when this appliance is operated and maintained according to instructions attached to or furnished with the product, Whirlpool Corporation will pay for FSP® replacement parts and repair labor for the CLEANTOP® ceramic glass cooktop.

Whirlpool Corporation warrants that the ceramic glass cooktop will not discolor, the cooktop pattern will not wear off, the rubber seal between the ceramic glass cooktop and porcelain edge will not crack, the ceramic glass cooktop will not crack due to thermal shock and the surface unit elements will not burn out. Service must be provided by a Whirlpool Corporation designated service company.

Whirlpool Corporation will not pay for:

1. Service calls to correct the installation of your appliance, to instruct you how to use your appliance, to replace house fuses or correct house wiring, or to replace owner-accessible light bulbs.
 2. Repairs when your appliance is used in other than normal, single-family household use.
 3. Pickup and delivery. Your appliance is designed to be repaired in the home.
 4. Damage resulting from accident, alteration, misuse, abuse, fire, flood, improper installation, acts of God or use of products not approved by Whirlpool Corporation.
 5. Repairs to CLEANTOP® ceramic glass cooktop if it has not been cared for as recommended in the Use and Care Guide.
 6. Repairs to parts or systems resulting from unauthorized modifications made to the appliance.
 7. Replacement parts or repair labor costs for units operated outside the United States.
-

WHIRLPOOL CORPORATION SHALL NOT BE LIABLE FOR INCIDENTAL OR CONSEQUENTIAL DAMAGES.

Some states do not allow the exclusion or limitation of incidental or consequential damages, so this exclusion or limitation may not apply to you. This warranty gives you specific legal rights and you may also have other rights which may vary from state to state.

Outside the 50 United States, this warranty does not apply. Contact your authorized Whirlpool dealer to determine if another warranty applies.

If you need service, first see the "Troubleshooting" section of this book. After checking "Troubleshooting," additional help can be found by checking the "Assistance or Service" section or by calling the Whirlpool Corporation Customer Interaction Center, 1-800-253-1301 (toll-free), from anywhere in the U.S.A.

3/00

Keep this book and your sales slip together for future reference. You must provide proof of purchase or installation date for in-warranty service.

Write down the following information about your range to better help you obtain assistance or service if you ever need it. You will need to know your complete model number and serial number. You can find this information on the model and serial number label/plate, located on your appliance as shown in the "Parts and Features" section.

Dealer name _____

Address _____

Phone number _____

Model number _____

Serial number _____

Purchase date _____