



MULTIMEDIA PROJECTOR

SX80 Mark II

SX800

User's Manual



Table of Contents

Safety Instructions

Before Use

Projecting an Image

Useful Functions Available During a Presentation

Setting Up Functions from Menus

Projecting an Image from a Digital Camera or an
USB Flash Memory (SX80 II)

Connecting the Projector to Network (SX80 II)

Appendix

Index



ENG

Features of SX80 MarkII/SX800 Multimedia Projector

Thank you for purchasing a Canon projector.

The SX80 MarkII/SX800 Multimedia Projector (hereinafter referred to as "the projector") is a high-performance projector that is capable of projecting high-resolution computer screens, high-quality digital images (SX80 MarkII), images from digital cameras and USB flash memories (SX80 MarkII) on a large screen.

Major Features

Smooth and Beautiful Imaging Capability

Incorporation of AISYS, Canon's unique optical engine, and LCOS (Liquid Crystal On Silicon) achieves high brightness, high contrast ratio, and smooth and beautiful lattice-free images.

Native SXGA+ Resolution

Native SXGA+ resolution (1400 by 1050 dots) ensures projection of a high-quality image in a wider projection area with a high degree of resolution.

High-powered 1.5X Zoom Lens

1.5X zoom aspheric lens can project a 100-inch image when placed 3 m (9.8') to 4.9 m (16.1') away. (P35)

"Auto Setup Function" for Making Setup a Breeze

The keystone distortion is automatically adjusted for quick and easy setup of projector. (P52)

Equipped with HDMI Input Terminal (SX80 II)

Connecting the projector to AV equipment via HDMI terminal allows you to project high quality digital images. (P44)

Direct Projection of Images Taken by Digital Camera (SX80 II)

Capable of directly projecting images taken by PictBridge enabled digital cameras. (P114)

Direct Projection of Data on USB Flash Memories (SX80 II)

Capable of directly projecting JPEG images on USB flash memories. (P118)

"Off and Go" Feature

It can be unplugged and packed away immediately. (P68)

* Wait until the cooling fan stops before putting the projector in the carrying bag.

User-Friendly On-Screen Menu

Settings are organized by four tabs. You can easily find settings for each function. (P76-P112)

Compact and Easy-to-use Wireless Remote Control

It comes with a wireless remote control which allows you to control all functions of this projector. (P26)

Various Image Modes for a Particular Use of Your Projector (SX80 II)

When projecting a digital still photo image or an image that has been processed on an sRGB-compatible monitor, you can project the image with higher tone on the screen by incorporating the appropriate image correction function for the particular lighting environment.

It is useful when projecting the image in a photo studio, portrait studio, wedding reception hall, art museum, gallery, etc.

User's Manual (this document)

This is a User's Manual for the SX80 MarkII/SX800 Multimedia Projector. This manual provides detailed information on how to use the projector. Read this manual thoroughly to make the most of your projector and ensure safety.

Important Information and Quick Start Guide

First read document. It provides information about projector safety, cautions, quick start guide*, cleaning and replacing the air filter and lamp replacement.

* This guide shows an outline flowchart of the steps to start and stop the projector, as well as the functions available for projecting images.

Symbols of Button Operations

The projector can be operated using buttons on the remote control or the top control of the projector. The remote control allows you to operate all functions of the projector. In this document, the buttons operation is shown as below.

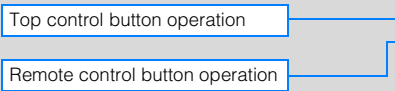

Symbols Used in This Manual

Meanings of the following symbols used in this manual are as follows:

(SX80 II): Function or description only applicable to SX80 MarkII.

(SX800): Function or description only applicable to SX800.

 A precaution about operation or restriction is given here.

Adjusting the Image Size

Use the **ZOOM** button to adjust the size of the proj. Change the projector installation position if your de adjust it with the zoom function. (P35)

1 Press the **ZOOM** button to pop up a window sho

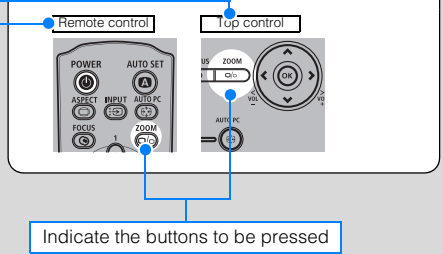

COPYRIGHT NOTICE

Please note that enlarging or reducing the size of an image for commercial purposes or public presentation may infringe on the legally protected copyright or the copyright holder of the original material.

About Trademarks

- Microsoft, Windows, Windows XP, Windows Vista and Internet Explorer are registered trademarks or trademarks of Microsoft Corporation in the United States and/or other countries.
- Macintosh and Mac are registered trademarks of Apple Computer, Inc., registered in the United States and/or other countries.
- HDMI, HDMI logo, and High Definition Multimedia Interface are registered trademarks or trademarks of HDMI Licensing, LLC.

Quick Reference Guide

This Quick Reference Guide will help you find functions that make full use of the projector, are useful in producing an attractive presentation, and so on.

Connecting the Projector

Connecting to the Computer (P40 – P43)
Connecting to AV Equipment (P44 – P47)
Connecting a Digital Camera (SX80 II)
(P48, P114 – P115)
Connecting an USB Flash Memory (SX80 II)
(P48, P118 – P119)

Projecting an Image

Starting Projection (P49 – P51)
Selecting an Input Signal (P54 – P55)
Projecting an Image from a Digital Camera
(SX80 II) (P114 – P117)
Projecting Data on USB Flash Memory
(SX80 II) (P118 – P124)

Adjusting Image

Adjusting the Image Size and Focus
(P58 – P59)
Adjusting Keystone Distortion (P60 – P61)
Adjusting Aspect Ratio (P62 – P66)
Eliminating Flickers from Computer Screen or
Adjusting Positional Shift (P82)

Adjusting Colors and Image Quality

Projecting an Image on a Greenboard (P86)
Selecting an Image Mode Suitable for the
Projecting Image (P93)
Making Fine Color Adjustments (P97, P100)
Removing Noise (P98)

Producing a Presentation

Blackened Out an Image Temporarily (P70)
Freezing the Picture (P70)
Adjusting the Volume (P71)
Muting the Sound (P71)
Zooming an Image (P72)
Showing the Elapsed Time (P73)

Ceiling Mounted Projection or Projecting from behind Screen (P87)

Changing Remote Control Channel (P107)

Resetting Projector Setting

Resetting the Image Settings (P102)
Resetting the Key Lock (P105)
Resetting Password (P108)
Resetting a Network Setting (SX80 II) (P111)
Resetting to the Default Setting (P111)

Miscellaneous Functions

Reducing the Lamp Brightness (P102)
Using the Power Saving Mode (P103)
Turning on the Projector by Connecting the
Power Cord (P104)
Disabling the Beep During the Operation
(P104)
Disabling Buttons (P105)
Hiding Guide Messages (P106)
Turning Off the Projector LED Lamps (P106)
Setting a Password (P108)

Table of Contents

Features of SX80 MarkII/SX800 Multimedia Projector	2
Quick Reference Guide.....	5
Safety Instructions.....	12
Safety Precautions	13
■ READ AND KEEP THIS OWNER'S MANUAL FOR LATER USE.....	14
AC Power Cord Requirement.....	16
Federal Communication Commission Notice	17
Canadian Radio Interference Regulations	17
Precautions on Handling the Batteries in the Remote Controller.....	18
Lamp Handling Precautions	18
Carrying/Transporting the Projector	19
Installation Precautions	19
Before Use	21
Supplied Accessories.....	22
■ Installing the Lens Cap	22
■ Putting the Projector in the Carrying Bag	23
Part Names	24
Main Unit of Projector.....	24
■ Front Side.....	24
■ Rear Side	24
■ Bottom Side.....	25
Remote Control	26
Top Control.....	28
Input Terminals.....	29
■ SX80 MarkII	29
■ SX800.....	29
Preparing the Remote Control	31
■ Installing Remote Control Batteries.....	31
■ Remote Control Operating Range	31
Projecting an Image	33
Steps for Setting Up the Projector and Projecting an Image.....	34
Setting Up the Projector	35
■ Placing in Front of the Screen.....	35
■ Placing on a Level Place.....	36
■ When Pointing the Projector Up.....	37
Connecting the Projector	38
Connectable Equipment and Input Terminals	38
■ SX80 MarkII.....	38
■ SX800.....	39
Connecting the Projector to the Computer.....	40
■ Connecting to RGB Monitor Output Terminal (analog connection).....	40
■ Connecting to DVI Monitor Output Terminal (digital connection) (SX80 II)	42
■ Outputting an Image and Audio	42
Connecting to AV Equipment.....	44
■ Connecting to Digital Video Output Terminal (digital connection) (SX80 II).....	44
■ Connecting to Analog Video Output Terminal (analog connection)	45

■ Outputting Audio to Speakers	47
■ Connecting a Digital Camera or an USB Flash Memory (SX80 II)	48
Starting Projection	49
■ When the Language Selection Screen Appears	50
■ When the Password Input Screen Appears	51
■ When "No signal" Appears.....	51
■ When Notebook Computer Screen Does Not Appear.....	51
■ Adjusting Image	51
Changing Notebook Computer Screen Output	51
■ Turning On External Monitor Output.....	51
Setting Up the Screen Automatically	52
Auto Setup	52
■ Performing the Auto Setup	53
Selecting an Input Signal (INPUT)	54
■ Types of Input Signals	54
■ Selecting an Input Signal.....	55
Adjusting Image	56
Setting the Display Resolution of the Computer	56
■ Windows Vista	56
■ Windows XP.....	56
■ Macintosh OSX.....	56
AUTO PC.....	57
■ Performing the Auto PC Function	57
Adjusting the Image Size	58
Adjusting the Focus	59
■ Auto focusing (SX80 II).....	59
■ Manual focusing	59
Adjusting Keystone Distortion.....	60
■ Auto adjustment.....	60
■ Manual adjustment	60
■ Resetting the Keystone Adjustment	61
Selecting Screen Aspect and Aspect	62
Selecting Screen Aspect.....	62
■ Moving Image with 16:9 D. Image Shift.....	64
■ Resetting the Image Shift	64
Selecting Aspect Ratio.....	65
■ Types of Aspect Ratios.....	65
■ How to Select an Aspect Ratio	66
Selecting an Image Mode	67
■ Image modes.....	67
■ How to Select an Image Mode	67
Turning Off the Projector.....	68
Useful Functions Available During a Presentation	69
Useful Functions Available During a Presentation	70
Blackened Out an Image Temporarily	70
Freezing the Picture.....	70
Adjusting the Volume.....	71

Muting the Sound	71
Zooming an Image	72
Showing the Elapsed Time.....	73
Projecting Image Without Computer (SX80 II)	73
Setting Functions from Menus	75
How to Use Menus	76
■ Menu Configuration.....	76
■ Basic Operation of Menu	77
Setting Display Status	79
Selecting an Image Projection Mode.....	79
Selecting an Input Signal Type (ANALOG PC)	80
Selecting an Input Signal Type (VIDEO/S-VIDEO)	80
Selecting an Input Signal Type (COMPONENT).....	81
Adjusting Input Signal (ANALOG PC) – Total Dots.....	81
Adjusting Input Signal (ANALOG PC) – Tracking	82
Adjust Input Signal (ANALOG PC) – Horizontal position	82
Adjust Input Signal (ANALOG PC) – Vertical position.....	83
Adjust Input Signal (ANALOG PC) – Horizontal pixels.....	83
Adjust Input Signal (ANALOG PC) – Vertical pixels.....	84
Selecting HDMI Input Level (SX80 II).....	84
Select HDMI Over Scan (SX80 II)	85
Performing Progressive Processing	85
Selecting a Menu Position.....	86
Correcting the Screen Color.....	86
Reversing projection.....	87
Capturing a Logo (SX800).....	88
Selecting the User Logo Display Position (SX800)	88
No Signal Screen (SX80 II)	89
Screen When Blank (SX80 II)	89
Selecting a Logo at Startup (SX80 II).....	90
No Signal Screen (SX800)	90
Screen When Blank (SX800)	91
Selecting a Logo at Startup (SX800).....	91
Selecting Aspect Ratio of Screen.....	92
Setting the Image Quality	93
Selecting an Image Quality	93
Adjusting the Brightness.....	94
Adjusting the Contrast.....	94
Adjusting the Sharpness	95
Making a Gamma Correction	95
Making Color Adjustment (HDMI) (SX80 II)	96
Making Color Adjustment (Digital PC/Analog PC/USB) (SX80 II).....	96

Making Color Adjustment (COMPONENT/VIDEO/S-VIDEO) (SX80 II)	97
Making Color Adjustment (Analog PC) (SX800)	97
Making Color Adjustment (COMPONENT/VIDEO) (SX800)	98
Making Advanced Adjustment (Noise reduction)	98
Making Advanced Adjustment (Dynamic gamma)	99
Making Advanced Adjustment (Mem. color correct) (SX80 II)	99
Making Advanced Adjustment (Auto fleshtone) (SX800)	100
Adjusting Fine Color Adjustment (6-axis color adjust) (SX80 II)	100
Correcting the Image According to the Ambient Light (SX80 II)	101
Reducing the Lamp Brightness	102
Resetting the Image Settings	102
Setting Various Function	103
Setting Auto Setup Function	103
Selecting the Power Management Mode	103
Skip the POWER Button Operation	104
Enabling/Disabling the Beep	104
Prohibiting the Projector Operation	105
Selecting a Display Language	105
Showing/hiding the Guide Screen	106
Turning on/off LED Illumination	106
Setting for Slideshow (SX80 II)	107
Setting up the Remote Control Channel	107
Extending the Menu Display Time	108
Setting a Password	108
Registering a Password	109
Resetting the Lamp Counter	109
■ About the Display of the Lamp Counter	110
Initializing network settings (SX80 II)	111
Resetting to the Default Setting	111
Checking the Information of the Projector	112
Projecting an Image from a Digital Camera or an USB Flash Memory (SX80 II)	113
Projecting an Image from a Digital Camera (SX80 II)	114
Connecting a Digital Camera	114
Operating the Projected Image	116
■ Switching to the Next Image	116
■ Rotating an Image	116
Running a Slideshow	117
■ Setting a Slideshow Interval	117
■ Finishing projection	117
Projecting Data on USB Flash Memory (SX80 II)	118
Connecting an USB Flash Memory	118
Description of USB File Browser	120

Selecting an Image for Projection	121
■ Selecting a Drive	121
■ Selecting a Folder	121
■ Selecting an Image File for Projection	122
Operating the Projected Image	123
■ Switching to the Previous/Next Image	123
■ Rotating an Image.....	123
■ Returning to the USB File Browser.....	123
Running a Slideshow of Data saved in a USB Flash Memory	124
■ Creating an Image File Folder	124
■ Setting a Slideshow Interval.....	124
Connecting the Projector to Network (SX80 II).....	125
Setting an IP Address (SX80 II).....	126
■ Setting IP Address of the Computer	126
■ Resetting the IP Address Setting of the Computer	127
Setting Network (SX80 II).....	128
■ Displaying the Network Configuration Screen	128
■ Setting the Network.....	129
■ Resetting the Network Setting.....	134
■ Error Notification Message.....	135
■ Projector Control	136
Appendix	137
Troubleshooting.....	138
WARNING Lamp Flash Patterns.....	138
Symptoms and Solutions.....	139
■ You cannot turn on the projector	139
■ You cannot project an image from the projector.	139
■ A digital camera or USB flash memory is not recognized. (SX80 II)	140
■ You cannot hear sound.....	140
■ The projected image is blur	141
■ You cannot project an image appropriately.	141
■ The projector is forced to be turned off.	141
■ You cannot operate the remote control.	142
Maintenance	143
Cleaning the Projector.....	143
Cleaning and Replacing the Air Filter.....	144
■ Cleaning the Air Filter.....	144
■ Replacing the Air Filter.....	144
Replacing the Lamp	145
■ About the Replacing Lamp	145
■ Replacing the Lamp.....	146
Relationship between Aspect and Screen Aspect.....	147
When Projecting an Image from a Computer.....	147
When Projecting an Image from Image Software.....	148
When Projecting an Image from a Digital Camera or a USB Flash Memory (SX80 II)	149

Supported Computer Signal Types	150
Relationship between Screen Size and Projecting Distance	151
Glossary	152
Specifications	156
■ Projector	156
■ Remote Control	156
■ External View	157
■ ANALOG PC-1 (SX800), ANALOG PC-2/COMPONENT IN terminal	157
■ Service Port (CONTROL)	158
Index	160
Menu Configuration	164





Safety Instructions

Before operating this projector, read this manual thoroughly in order to operate the projector properly.

This projector offers many convenient features and functions. Operating the projector properly enables you to manage those features and maintain it in good condition for a long period.

Improper operation may result in not only reducing the product-life, but also malfunctions, fire hazards, or other accidents.

If your projector is not operating correctly, read this manual again, check operations and cable connections, and try the solutions shown in the "Troubleshooting" section at the end of this booklet. If the problem still persists, contact the service center or the dealer where you purchased the projector.

	CAUTION RISK OF ELECTRIC SHOCK DO NOT OPEN	
CAUTION: TO REDUCE THE RISK OF ELECTRIC SHOCK, DO NOT REMOVE COVER (OR BACK). THERE ARE NO USER-SERVICEABLE PARTS INSIDE EXCEPT LAMPS. REFER SERVICING TO QUALIFIED SERVICE PERSONNEL.		
	THIS SYMBOL INDICATES THAT DANGEROUS VOLTAGE CONSTITUTING A RISK OF ELECTRIC SHOCK IS PRESENT WITHIN THIS UNIT.	
	THIS SYMBOL INDICATES THAT THERE ARE IMPORTANT OPERATING AND MAINTENANCE INSTRUCTIONS FOR THIS UNIT IN THE OWNER'S MANUAL.	

CAUTION Not for use in a computer room as defined in the Standard for the Protection of Electronic Computer/Data Processing Equipment, ANSI/NFPA 75.
--

Safety Precautions

WARNING: TO REDUCE THE RISK OF FIRE OR ELECTRIC SHOCK, DO NOT EXPOSE THIS APPLIANCE TO RAIN OR MOISTURE.

- This projector projects intense light from the projection lens. Do not stare directly into the lens if possible, as doing so may result in eye damage. Be especially careful that children do not stare directly into the beam.
- Install the projector in an appropriate position. Installing the projector in an inappropriate position may result in a fire hazard.
- Allow for appropriate space above, beside and behind of the projector cabinet for allowing air circulation and cooling of the projector. Minimum clearances must be maintained. If the projector is to be built into a compartment or similarly space, the minimum distances must be maintained. Do not cover the ventilation slot on the projector. Heat build-up can reduce the service life of your projector, and can also be dangerous.

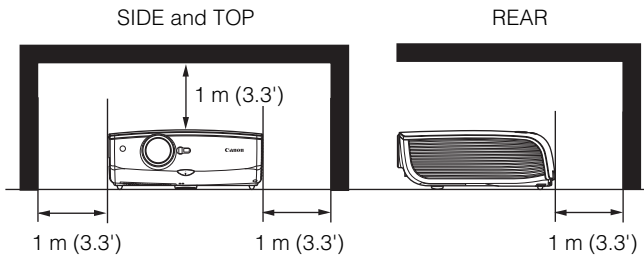

- Do not put any flammable objects or spray cans near the projector, as the hot air exhausted from the ventilation holes may result in an explosion.
- If the projector is not to be used for an extended period of time, unplug it from the power outlet.

■ **READ AND KEEP THIS OWNER'S MANUAL FOR LATER USE.**

All the safety and operating instructions should be read before beginning to operate the product.

Read all of the instructions given here and retain them for later use. Unplug this projector from the AC power supply before cleaning. Do not use liquid or aerosol cleaners on the projector. Use a damp cloth for cleaning.

Follow all warnings and instructions marked on the projector.

For added protection of the projector during a lightning storm, or when it is left unattended or unused for long periods of time, unplug it from the wall outlet. This will prevent damage due to lightning and power surges.

Do not expose this unit to rain or use near water... for example, in a wet basement, near a swimming pool, etc...

Do not use attachments not recommended by the manufacturer as they may result in hazards.

Do not place this projector on an unstable cart, stand, or table. The projector may fall, causing serious injury to a child or adult, and serious damage to the projector. Use only with a cart or stand recommended by the manufacturer, or sold with the projector. Wall or shelf mounting should be carried out in accordance with the manufacturer's directions, and should use a mounting kit approved by the manufacturers.

An appliance and cart combination should be moved with care.

Sudden stops, excessive force, and uneven surfaces may cause the appliance and cart combination to overturn.



Slots and openings in the back and bottom of the cabinet are provided for ventilation, to insure reliable operation of the equipment and to protect it from overheating.

The openings should never be covered with cloth or other materials, and the bottom opening should not be blocked by placing the projector on a bed, sofa, rug, or other similar surface. This projector should never be placed near or over a radiator or heat register.

This projector should not be placed in a built-in installation such as a book case unless proper ventilation is provided.

Never push objects of any kind into this projector through cabinet slots as they may touch dangerous voltage points or short out parts that could result in a fire or electric shock. Never spill liquid of any kind onto the projector.

Do not install the projector near the ventilation duct of air-conditioning equipment.

This projector should be operated using only the type of power source indicated on the marking label. If you are not sure of the type of power supplied, consult your authorized dealer or local power company.

Do not overload wall outlets and extension cords as this can result in fire or electric shock. Do not allow anything to rest on the power cord. Do not locate this projector where the cord may be damaged by people walking on it.

Do not attempt to service this projector yourself as opening or removing covers may expose you to dangerous voltages or other hazards. Refer all servicing to qualified service personnel.

Unplug this projector from the wall outlet and refer servicing to qualified service personnel under the following conditions:

- a. When the power cord or plug is damaged or frayed.
- b. If liquid has been spilled into the projector.
- c. If the projector has been exposed to rain or water.
- d. If the projector does not operate normally after following the operating instructions. Adjust only those controls that are covered in the operating instructions as improper adjustment of other controls may result in damage and will often require extensive work by a qualified technician to restore the projector to normal operating condition.
- e. If the projector has been dropped or the cabinet has been damaged.
- f. When the projector exhibits a distinct change in performance-this indicates a need for servicing.

When replacement parts are required, be sure the service technician uses replacement parts specified by the manufacturer that have the same characteristics as the original parts. Unauthorized substitutions may result in fire, electric shock, or injury.

Upon completion of any service or repairs to this projector, ask the service technician to perform routine safety checks to determine that the projector is in safe operating condition.

AC Power Cord Requirement

The AC Power Cord supplied with this projector meets the requirements for use in the country you purchased it.

AC Power Cord for the United States and Canada:

The AC Power Cord used in the United States and Canada is listed by the Underwriters Laboratories (UL) and certified by the Canadian Standard Association (CSA).

The AC Power Cord has a grounding-type AC line plug. This is a safety feature to ensure the plug fits into the power outlet. Do not try to tamper with this safety feature. Should you be unable to insert the plug into the outlet, contact your electrician.

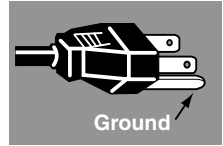

THE SOCKET-OUTLET SHOULD BE INSTALLED NEAR THE EQUIPMENT AND EASILY ACCESSIBLE.

NOTE FOR CUSTOMERS IN THE US

(Hg) LAMP(S) INSIDE THIS PRODUCT CONTAIN MERCURY AND MUST BE RECYCLED OR DISPOSED OF ACCORDING TO LOCAL, STATE OR FEDERAL LAWS.



European Union (and EEA) only.

These symbols indicate that this product is not to be disposed of with your household waste, according to the WEEE Directive (2002/96/EC), the Battery Directive (2006/66/EC) and/or your national laws implementing those Directives. If a chemical symbol is printed beneath the symbol shown above, in accordance with the Battery Directive, this indicates that a heavy metal (Hg = Mercury, Cd = Cadmium, Pb = Lead) is present in this battery or accumulator at a concentration above an applicable threshold specified in the Battery Directive. This product should be handed over to a designated collection point, e.g., on an authorized one-for-one basis when you buy a new similar product or to an authorized collection site for recycling waste electrical and electronic equipment (EEE) and batteries and accumulators. Improper handling of this type of waste could have a possible impact on the environment and human health due to potentially hazardous substances that are generally associated with EEE. Your cooperation in the correct disposal of this product will contribute to the effective usage of natural resources. For more information about the recycling of this product, please contact your local city office, waste authority, approved scheme or your household waste disposal service or visit www.canon-europe.com/environment.



(EEA: Norway, Iceland and Liechtenstein)

Federal Communication Commission Notice

Multimedia Projector, Model: SX80 MarkII/SX800

This device complies with Part 15 of the FCC Rules. Operation is subject to the following two conditions:

- (1) This device may not cause harmful interference, and
- (2) this device must accept any interference received, including interference that may cause undesired operation.

Note: This equipment has been tested and found to comply with the limits for a Class B digital device, pursuant to Part 15 of the FCC Rules. These limits are designed to provide reasonable protection against harmful interference in a residential installation. This equipment generates, uses and can radiate radio frequency energy and, if not installed and used in accordance with the instructions, may cause harmful interference to radio communications. However, there is no guarantee that interference will not occur in a particular installation. If this equipment does cause harmful interference to radio or television reception, which can be determined by turning the equipment off and on, the user is encouraged to try to correct the interference by one or more of the following measures:

- Reorient or relocate the receiving antenna.
- Increase the separation between the equipment and receiver.
- Connect the equipment into an outlet on a circuit different from that to which the receiver is connected.
- Consult the dealer or an experienced radio/TV technician for help.

The cable with a ferrite core provided with the projector must be used with this equipment in order to comply with Class B limits in Subpart B of Part 15 of the FCC rules.

Use of a shielded cable is required to comply with class B limits in Subpart B of Part 15 of FCC Rules.

Do not make any changes or modifications to the equipment unless otherwise specified in the instructions. If such changes or modifications should be made, you could be required to stop operation of the equipment.

Canon U.S.A., Inc.

One Canon Plaza, Lake Success, NY 11042, U.S.A.

Tel No. (516) 328-5600

Canadian Radio Interference Regulations

This Class B digital apparatus complies with Canadian ICES-003.

Precautions on Handling the Batteries in the Remote Controller



Observe the following precautions when handling the batteries. Failure to do so may cause explosion, heat generation, fire, or leakage of the battery fluid.

- Do not heat or disassemble the batteries, or throw them into fire.
- Do not attempt to recharge the batteries.



Observe the following precautions when handling the batteries. Failure to do so may cause explosion, heat generation, fire or leakage of the battery fluid.

- Remove the batteries when they have been exhausted or not in use for an extended period of time.
- Be sure to replace both batteries at the same time. Do not mix batteries of different types.
- Insert batteries correctly according to the "+" and "-" markings.
- If a fluid from a battery leaks and comes in contact with your skin, rinse the affected skin thoroughly as soon as possible.

Lamp Handling Precautions

This projector uses a high-pressure mercury lamp which must be handled carefully and correctly as mentioned below.

The mercury lamp has the following characteristics.

- A lamp may explode with a loud sound or burn out due to a shock, scratch, or use beyond its expiry date.
- The lamp life may differ from lamp to lamp and according to the usage environment. There is no guarantee that all lamps will last for the same period of time. Some lamps may fail in a shorter period of time than other similar lamps.
- A lamp gradually becomes darker over time.



If a Lamp Explodes

- If a lamp explodes, gas or dust may come out of the exhaust vent. Open windows and doors for ventilation.
- The gas contains toxic mercury. Always keep your face away from the exhaust vent when the projector is operating to avoid inhaling mercury vapors or to prevent it from getting in your eyes or mouth.
- If you inhale the gas or the shards of the broken lamp contact your eyes or mouth, consult a doctor immediately.
- If a lamp explodes, its shards may scatter inside the projector. Ask the Canon service representative to clean and check the inside of the projector and replace the lamp.



If the projector indicates that the lamp should be replaced (i.e., the LAMP REPLACE indicator lights up twice),

- The chances of an explosion increase. Replace the lamp with a new one immediately if such is the case.



Disposal of Waste Lamp

- Dispose of the projector's mercury lamp according to local regulations just like the fluorescent lamps.

Carrying/Transporting the Projector



- This projector is a precision machine. Do not subject the projector to strong shocks or vibrations or turn it down.
- Install the lens cap to protect the lens and put the projector in the carrying bag to protect it from dust and scratches on the surface of it when you carry the projector. For details, see [P23](#).
- Wait until the cooling fan stops before putting the projector in the carrying bag. Do not put the projector in the carrying bag until the cooling fan stops rotating. The projector may be damaged due to the heat.
- Replace the adjustable foot before putting the projector in the carrying bag. The projector may be damaged if you put it in the bag without replacing the adjustable foot.
- The carrying bag is not designed to protect the projector from external shocks. When carrying the projector with it put in the carrying bag, do not give a shock to it, drop it, or place anything on it. The projector may be damaged or malfunctioned.
- Do not transport the projector through a courier or transport service with the carrying bag. Put the projector in an impact-resistant transport case if such is the case.

Installation Precautions



The area around the exhaust vent and the cabinet above the exhaust vent become hot when the projector is operating.

- Do not touch these areas, or you may get burnt. In particular, keep children away from these areas. Do not put anything that may deform or discolor due to heat on the projector.

Hot air is exhausted from the exhaust vent. Observe the following:

- Do not put any metallic object on the projector. It may become hot, resulting in accident or injury.
- Do not seat anyone near the exhaust vent. Otherwise, you may get burned.

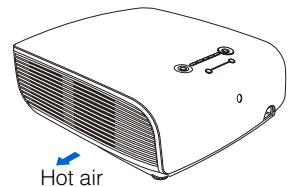

When placing the projector on a castered stand or table, be sure to lock the casters.

- Failure to do so may cause the projector to move or topple, resulting in an injury.



Position the projector in a horizontal position. Incorrect installation may cause troubles and accidents.

- Do not tilt the projector more than 20 degrees above and below the horizontal.
- When you want to use your projector pointing up or down, make sure to place the projector straight up or down.

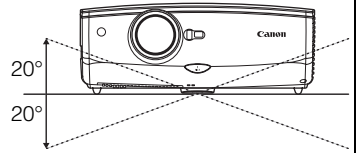

Do Not Use in the Following Environments

- Do not place the projector on an unstable or slanted surface. The projector may fall causing a personal injury.
- Do not place it in an oily, smoky, or damp location (e.g., near a cooking table or a humidifier). It may cause a fire or an electric shock.
- Place the projector with a minimum distance of 1 m (3.3') from its left, right, rear, and top panels to the neighboring object such as a wall. Otherwise, it may damage the projector due to bad exhaust ventilation.
- Do not put anything near the exhaust vent that may deform or deteriorate due to heat.
- Do not install the projector in a humid or dusty location or a position where there is a lot of oily or cigarette smoke. Optical parts such as a lens and mirror may be stained, resulting in poor picture quality.
- Do not place it near an exhaust outlet of air-conditioning equipment. Otherwise, it may be damaged.

If the projector is carried from a cold place to a warm place or the room temperature is raised rapidly, condensation may form on the lens and mirror due to the moisture in the atmosphere, resulting in a blurred picture. Wait until condensation evaporates and normal picture is shown.

Do not use the projector in a place subject to either very high or very low temperatures. Doing so may cause malfunction. The ranges of the operating and storage temperatures are as shown below:

Operating temperature: +5°C to +35°C (Humidity: 85% or below)

Storage temperature: -10°C to +60°C (Humidity: 90% or below)

Using the Projector at 2300 Meters or More Above Sea Level

- If you use the projector at 2300 meters or more above sea level, the special configuration is required to cool down the projector properly. Contact your dealer.

Before Use

Table of Contents

Safety Instructions

Before Use

Projecting an Image

Useful Functions Available During a Presentation

Setting Up Functions from Menus

Projecting an Image from a Digital Camera or an
USB Flash Memory (SX80 II)

Connecting the Projector to Network (SX80 II)

Appendix

Index

Supplied Accessories

Check whether the following accessories are supplied with the projector.

- Remote control

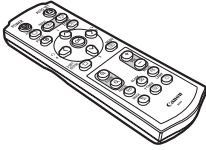

- Batteries (type AAA, two) for remote control

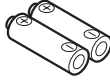

- Computer connection cable (DVI/Mini D-sub, 15-pin) (SX80 II) YH7-2052

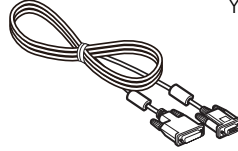

- Power cord

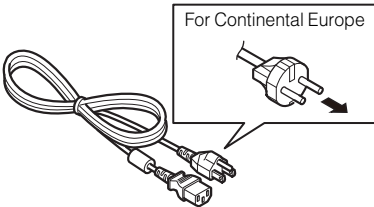

For the U.S.A and Canada

- Component cable (RCA/Mini D-sub, 15-pin) YH7-2084

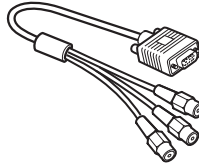

- Computer connection cable (VGA/Mini D-sub, 15-pin) (SX800) YH7-2307

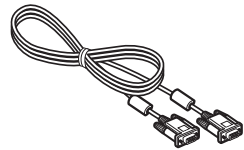

- Lens cap

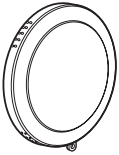

- Lens cap strap

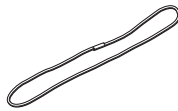

- Carrying bag

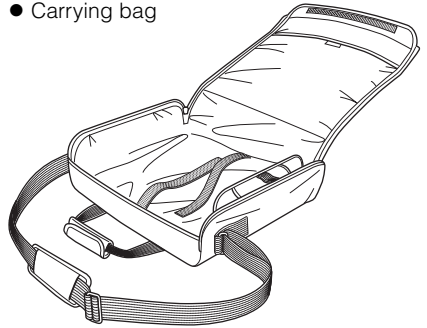

- User's Manual (CD-ROM)
- Warranty card
- Important Information and Quick Start Guide

■ Installing the Lens Cap

As shown in the illustration on the right, put the lens cap strap through the hole on the lens cap, and then through the lens cap strap insertion hole at the bottom of the projector.

- When the projector is not in use, attach the lens cap to protect the lens.

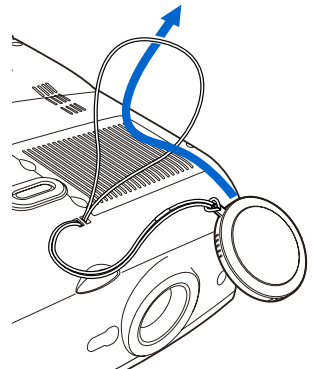

■ Putting the Projector in the Carrying Bag

Store the projector and the accessories in the carrying bag as shown in the illustration below.

The carrying bag is intended to protect the surfaces of the projector from dust or scratches, and is not designed to protect the projector from external shocks.

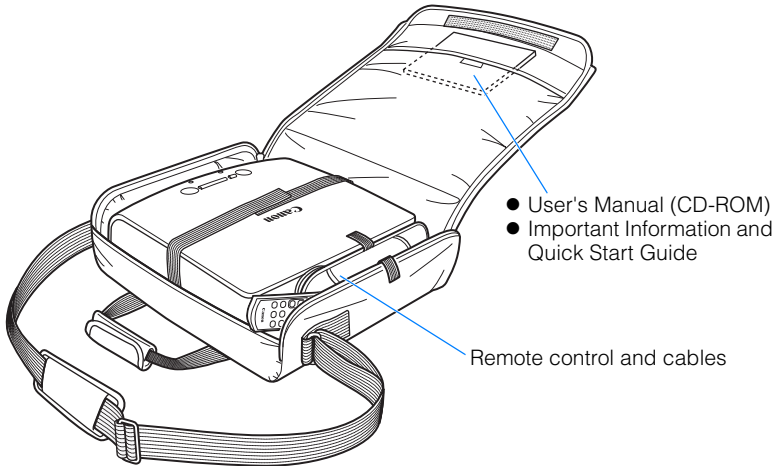



- Wait until the cooling fan stops before putting the projector in the carrying bag. Do not put the projector in the carrying bag until the cooling fan stops rotating. The projector may be damaged due to the heat.
- Attach the lens cap to the lens to protect it and put the projector in the carrying bag. Replace the adjustable foot to prevent the damage on the projector.
- When carrying the projector with it put in the carrying bag, do not give a shock to it, drop it, or place anything on it. The projector may be damaged or malfunctioned.

Part Names

Main Unit of Projector (SX80 MarkII is used in the following illustrations)

■ Front Side

 **Anti-theft lock hole**
An anti-theft wire cable available on the market can be connected.

 **Caution**
Be sure to remove the lens cap during projection. Failure to do so will result in fire hazards or cap deformation.

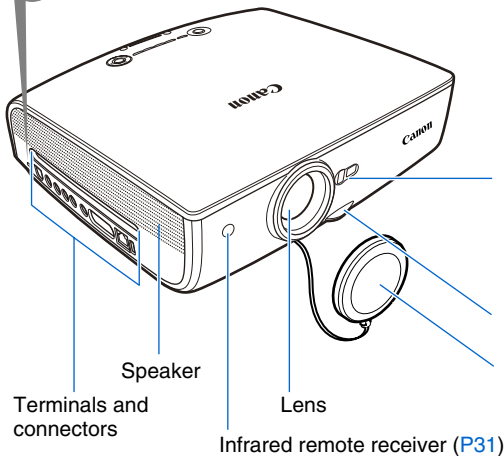



Ranging window (SX80 II)
Do not place any obstacle between the projector and the screen, as the auto focusing function may fail to operate correctly.

Adjustable foot lock button (P37)

Lens cap (P22)

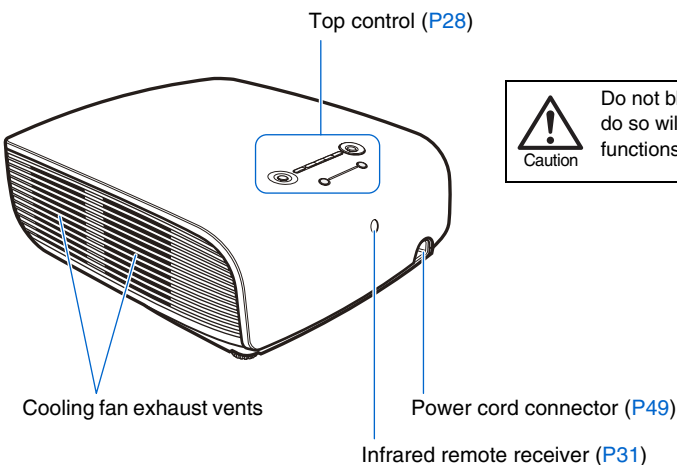
■ Rear Side



 **Caution**
Do not block the air exhaust. Failure to do so will result in fire hazards or malfunctions.

Bottom Side

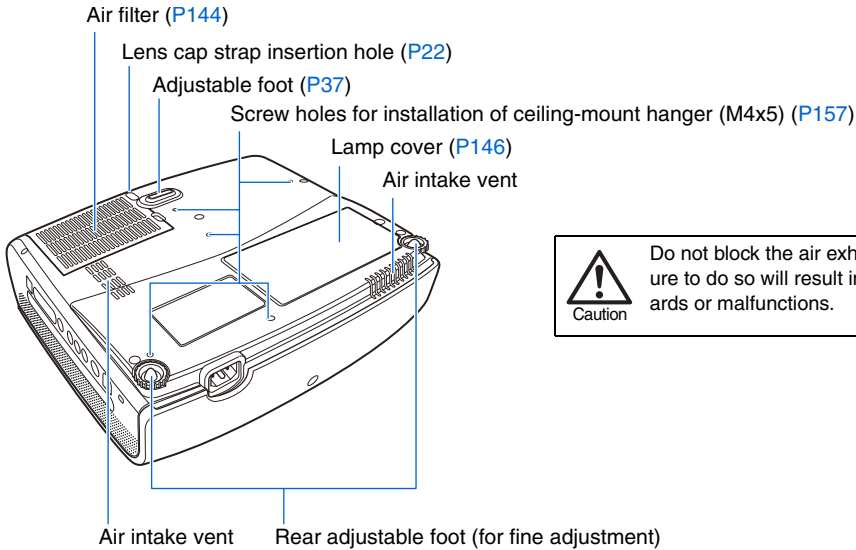

Caution

Do not block the air exhaust. Failure to do so will result in fire hazards or malfunctions.

Before Use

Mounting the Projector on the Ceiling

You can mount the projector on the ceiling. You need an optional ceiling mounting hanger (part number: RS-CL10) and an optional ceiling-mount pipe (part number: RS-CL08 or RS-CL09) when appropriate. Contact the dealer where you purchased the projector for more detailed information.



- Make sure to use the optional ceiling-mount hanger.
- You should never install the ceiling-mount hanger by yourself.
- If you mount the projector on the ceiling, you have to invert the projected image by selecting [Image flip H/V] from the menu. (P87)

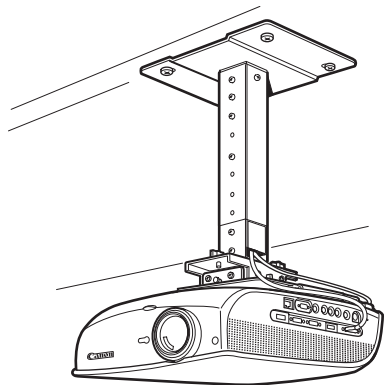

Remote Control

The projector can be operated using buttons on the remote control or the top control on the main unit.

The remote control allows you to operate all functions of the projector.

POWER button (P49, P68)

Turns the projector on or off.

ASPECT button (P66)

Toggles between the modes for aspect ratio.

FOCUS button (P59)

Adjusts focusing.

[^] [v]: For rough adjustment.

[<] [>]: For fine adjustment.

In SX80 MarkII, press **FOCUS** and then **AUTO SET** to adjust the focus automatically.

D.SHIFT/KEystone button (P60)

Corrects keystone distortion.

[^] [v]: For keystone adjustment.

Press **D.SHIFT/KEystone** and then **AUTO SET** to adjust the keystone automatically.

- Moves the image up and down when the D. image shift is selected. (P64)
- [^] [v]: Adjust the vertical position.

D. ZOOM button (P72)

Zooms the image in or out digitally.

[+]: Zooms the image in (up to 12x).

[-]: Zooms the image out (1x minimum).

[^] [v] [<] [>]: Moves an image to the desired position.

FREEZE button (P70)

Freezes the projected image.

IMAGE button (P67)

Switches among image modes (image qualities).

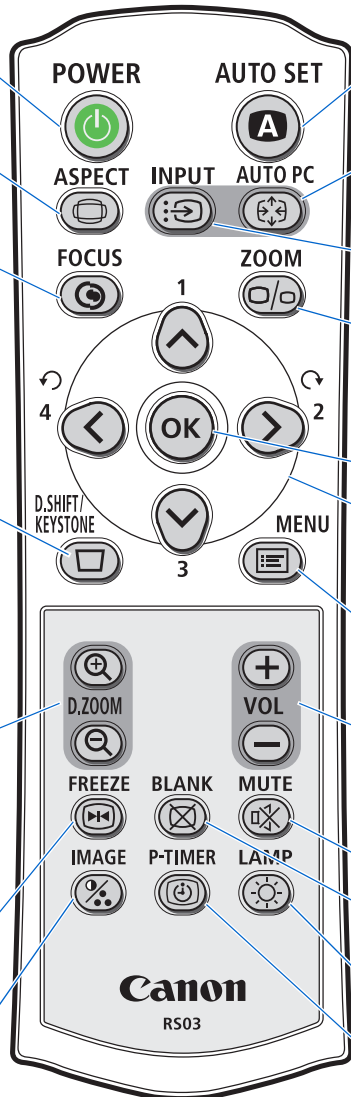

AUTO SET button (P53)

Performs input signal setting, keystone distortion adjustment, focusing (SX80 II), and screen color correction (SX80 II) automatically.

INPUT button (P55)

Switches among input signals.

ZOOM button (P58)

Adjusts the image size.

[^] [v]: For rough adjustment.

[<] [>]: For fine adjustment.

Pointer buttons (P77)

Selects the upper, lower, left or right item in the menu.

MENU button (P76)

Displays a menu on the screen.

VOL button (P71)

Adjusts the sound volume.

[+]: Increases the volume.

[-]: Decreases the volume.

BLANK button (P70)

Toggles between display/non-display of image.

P-TIMER button (P73)

Displays the time elapsed since this button was pressed.

AUTO PC button (P57)

Adjusts tracking and so on automatically in accordance with signal from a computer when ANALOG PC-1 or ANALOG PC-2 is selected.

OK button (P78)

Determines the item selected from the menu.

MUTE button (P71)

Mutes the sound.

LAMP button (P102)

Switches the lamp mode between Standard and Silent.

Top Control

KEYSTONE button (P60)

Corrects keystone distortion. (P60)
 [^] [v]: For keystone adjustment.
 Press **KEYSTONE** and then **AUTO SET** to adjust the keystone automatically.

- Moves the image up and down when the D. image shift is selected. (P64)
- [^] [v]: Adjust the vertical position.

MENU button (P76)

Displays a menu on the screen.

AUTO SET button (P53)

Performs input signal setting, keystone distortion adjustment, focusing (SX80 II), and screen color correction (SX80 II) automatically.

FOCUS button (P59)

Adjusts focusing.
 [^] [v]: For rough adjustment.
 [<] [>]: For fine adjustment.
 In SX80 MarkII, press **FOCUS** and then **AUTO SET** to adjust the focus automatically.

ZOOM button (P58)

Adjusts the image size.
 [^] [v]: For rough adjustment.
 [<] [>]: For fine adjustment.

OK button (P78)

Determines the item selected from the menu.

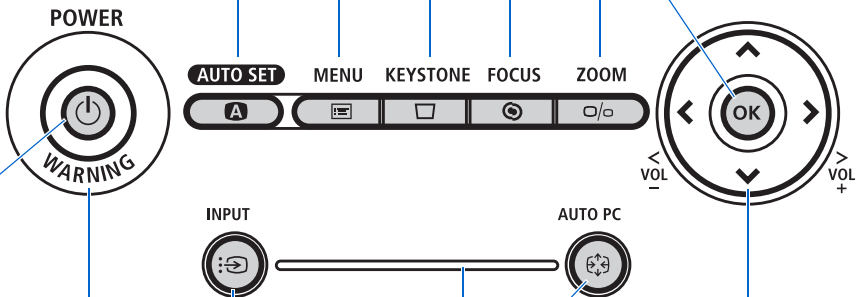

WARNING lamp (P138)

Flashes red when a problem has been detected on the projector.

POWER button/lamp (P49, P68)

Turns the projector on or off.
 Green: The projector is on.
 Flashing green: The projector is being turned on.
 Red: The projector can be turned on.
 Flashing red: The projector is being turned off (the lamp is being cooled).

INPUT button (P55)

Switches among input signals.

Pointer/VOL button (P77, P71)

Adjusts the sound volume.
 [<]: Decreases the volume.
 [>]: Increases the volume.
 Selects the upper, lower, left or right item in the menu.

AUTO PC button (P57)

Adjusts tracking and so on automatically in accordance with signal from a computer when ANALOG PC-1 or ANALOG PC-2 is selected.

LED illumination lamp (P106)

Indicates the projector status with LEDs.
 Blinking from the left: The projector is being turned on.
 Blinking from the right: The projector is being turned off.
 Middle LED flashing slowly: The image is being blanked out.
 Left and right LEDs flashing slowly: The image is freezing.

Input Terminals

■ SX80 MarkII

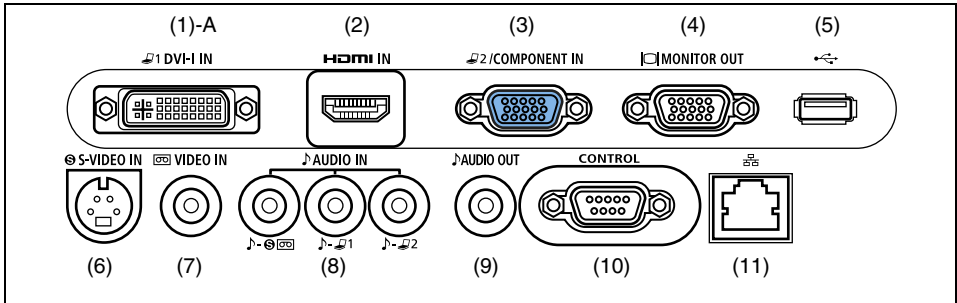

■ SX800

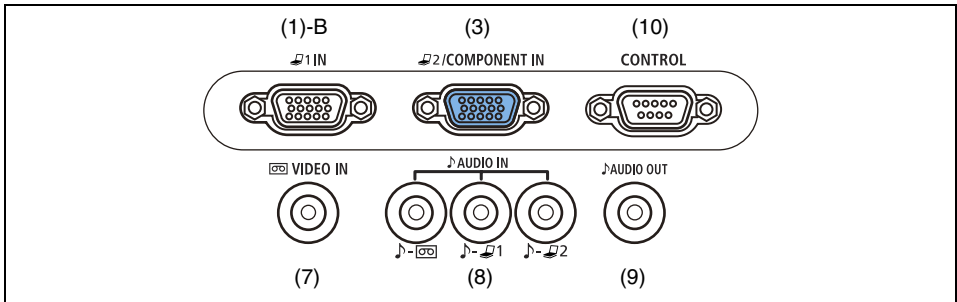

(1)-A ANALOG PC-1/DVI-I IN Input Terminal
(1 DVI-I IN) (SX80 II) (P40, P42)

(1)-B ANALOG PC-1 Input Terminal
(1 IN) (SX800) (P40)

Connects an external monitor output from a computer.

Receives an analog PC (ANALOG PC-1) or a digital signal (DIGITAL PC, SX80 II).

(2) HDMI IN Terminal (SX80 II) (P44)

Receives a digital content image signal (HDMI).

Carries both video and audio signals across a single cable.

(3) ANALOG PC-2/COMPONENT IN Terminal
(2/COMPONENT IN) (P41, P46)

Receives an analog PC signal (ANALOG PC-2).

Use a supplied component cable to receive a component image signal (COMPONENT).

(4) Monitor Output Terminal (MONITOR OUT) (SX80 II) (P42)

Outputs an analog RGB signal to display an image on an external monitor.

(5) USB Terminal (SX80 II) (P48)

Connects a digital camera or an USB flash memory.

(6) S-VIDEO IN Terminal (SX80 II) (P45)

Receives an S-Video signal from AV equipment.

(7) VIDEO IN Terminal (P45)

Receives a composite video signal from AV equipment.

(8) **♪ AUDIO IN Terminal (P40, P41, P42, P45, P46)**

The audio input terminals for 3 image input systems other than HDMI-IN.

They receive the following audio signals in order from the left.

SX80 MarkII: "S-VIDEO or VIDEO", "DIGITAL PC/ANALOG PC-1", and "ANALOG PC-2/COMPONENT"

SX800: "VIDEO", "ANALOG PC-1", and "ANALOG PC-2/COMPONENT"

The internal speaker outputs the audio signal for the selected image signal.

(9) **♪ AUDIO OUT Terminal (P43, P47)**

The audio output terminal to output an audio to external AV equipment. It outputs the audio signal corresponding to the projected image signal.

(10) **Service port (CONTROL)**

Exclusively used by the service personnel (it is not used normally).

(11) **LAN port (SX80 II) (P126)**

Connects a LAN cable.

Used to connect the projector to the network.

Preparing the Remote Control

■ Installing Remote Control Batteries

- 1** Open the battery compartment lid. Slide the lid with it pressed down.

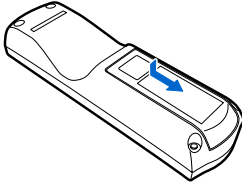

- 2** Insert batteries. Insert new two AAA-size batteries in the compartment with the + and - poles positioned correctly.

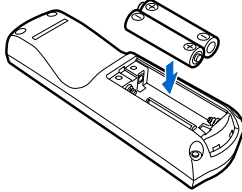

- 3** Replace the compartment lid.

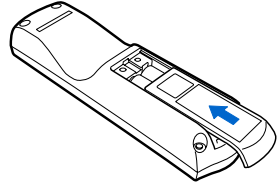

- If buttons on the remote control are inoperative when you attempt to operate the projector, replace the batteries with new ones.
- It is recommended to check the batteries before a presentation.

■ Remote Control Operating Range

Point the remote control to the infrared remote receiver on the front or rear of the projector whenever pressing any button.

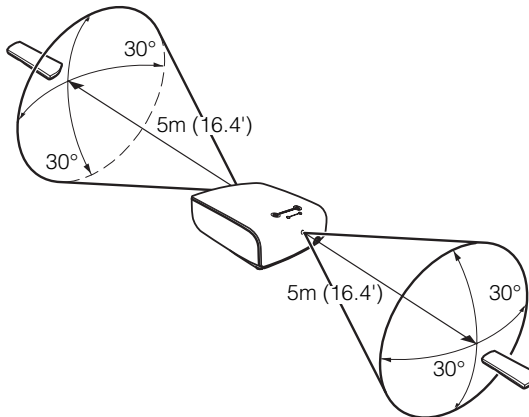

- Use the remote control within a distance of approximately 5 m (16.4') from the projector.
- Use the remote control within an angle of 30° in any direction from directly in front of the infrared remote receiver.
- The remote control may be inoperative if there is an obstacle between the remote control and main unit or the infrared remote receiver on the main unit is exposed to direct sunlight or strong light of lighting equipment.
- When you use two projectors at the same time, you can change the channel settings to prevent the two remote controls from interfering with each other. (P107)

Projecting an Image

Table of Contents

Safety Instructions

Before Use

Projecting an Image

Useful Functions Available During a Presentation

Setting Up Functions from Menus

Projecting an Image from a Digital Camera or an
USB Flash Memory (SX80 II)

Connecting the Projector to Network (SX80 II)

Appendix

Index

Steps for Setting Up the Projector and Projecting an Image

Connecting the Projector to Equipment (P38, P39)



Turning on the Power (P49)



Do you want to project an image from a notebook computer?

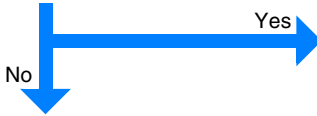

For a notebook computer, turn on the monitor output (P51) and then go to Auto Setup.

Performing the Auto Setup (P52)

Image projected properly?

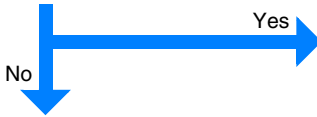

In SX800, manually adjust the focus.

Projection is complete.

Selecting an Input Signal (P54)

Image projected properly?

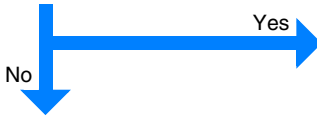

Projection is complete.

Adjusting the Image (P56)

Do the following adjustments.

- Setting the Display Resolution of the Computer (P56)
- Adjusting misaligned computer images or flickering of the screen using the Auto PC (P57)
- Adjusting the Image Size (P58)
- Adjusting the Focus (P59)
- Adjusting keystone Distortion (P60)

Making Fine Adjustments

- Selecting an Aspect Ratio of Projected Image (Screen aspect) and a Screen Mode (Aspect) (P62, P65)
- Selecting an Image Mode (P67)

Setting Up the Projector

■ Placing in Front of the Screen

Place the projector in front of the screen.



- Be sure to place the projector parallel to the screen to ensure distortion-free projections.
- The screen must not be exposed to direct sunlight or light from lighting equipment. In a bright room, it is recommended to limit ambient lighting in order to improve the image quality.

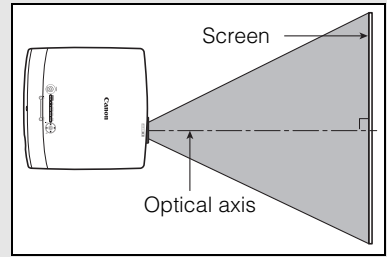

Projected Image Size

The projected image size is determined by the distance between the projector and the screen (projection distance) as well as the zoom (P58). For the relationship between the screen size and the projection distance, see also the table listed in "Relationship between Screen Size and Projecting Distance" on page 151.

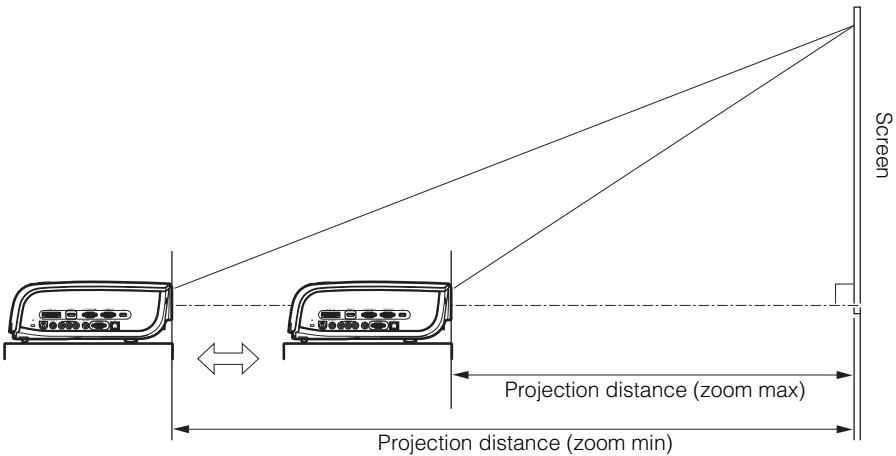

Screen size	40	60	80	100	150	180	200	250	300
Width (cm)	81	122	163	203	305	366	406	508	610
Height (cm)	61	91	122	152	229	274	305	381	457
Projection distance (zoom max)	1.2 m (3.9')	1.8 m (5.9')	2.4 m (7.9')	3.0 m (9.8')	4.5 m (14.8')	5.4 m (17.7')	6.0 m (19.7')	7.6 m (24.9')	9.1 m (29.9')
Projection distance (zoom min)	1.7 m (5.6')	2.6 m (8.5')	3.5 m (11.5')	4.4 m (14.4')	6.6 m (21.7')	8.0 m (26.3')	8.9 (29.2')	-	-

■ Placing on a Level Place

Be sure to keep the projector as horizontal as possible.

If you need to point the projector up (for example, when the screen is placed on a higher position), follow the instruction given in "When Pointing the Projector Up" on the following page.

- Adjust the tilt of the projecting image using the rear adjustable foot.

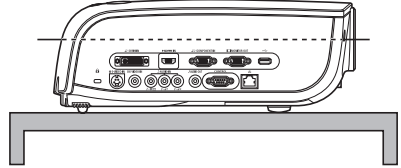
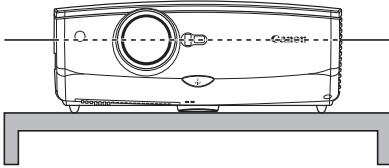

Make sure that the installation position is free from any obstacle that may block the exhaust vent on the right side of the projector and the air intake vent on the bottom of the projector.

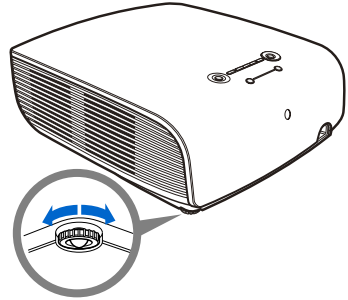

Ceiling Mounting or Rear Projection

You can mount the projector on the ceiling (Ceiling mounted) with it turned up side down or place it behind the screen (Rear) if you use a translucent screen. For ceiling mounting or rear projection, you have to invert the projected image. (P87)

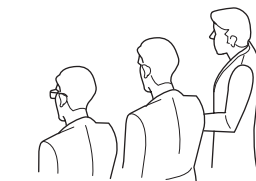
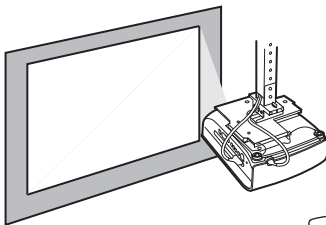

Ceiling Mounting

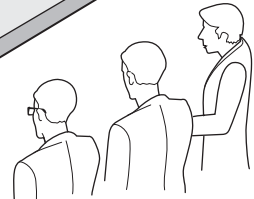
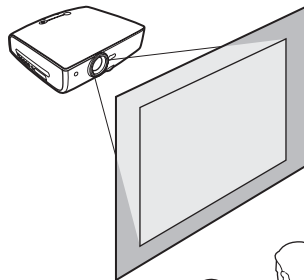

Rear Projection

■ When Pointing the Projector Up

When the screen is placed on a higher position, point the projector up using the adjustable foot.

You can point it up as far as 10 degrees.

The keystone distortion of the projecting image can be corrected with the auto keystone (P52) or by using the keystone distortion adjust function (P60).

- 1** Lift the front side of the projector and push the adjusting foot lock button to extend the adjustable foot.
- 2** Raise the image to the desired height angle, then release the button to lock the foot in place.

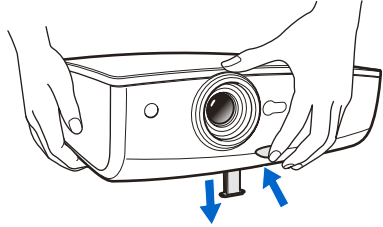

If Keystone Distortion is Too Large

If the keystone distortion is too large to adjust, adjust the projector height by, for example, placing it on a pedestal.

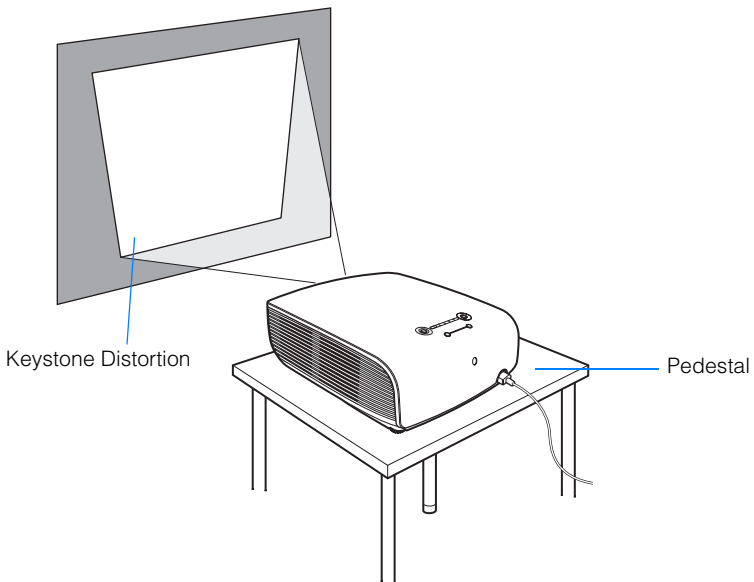

Connecting the Projector

Connectable Equipment and Input Terminals

DIGITAL PC ANALOG PC-1	Use this name to select the appropriate image.	↓ : Video signal or data flow
DVI-I IN terminal	The name of the terminal to which to connect equipment.	(Pxxx) : indicates the page(s) to refer to.

■ SX80 MarkII

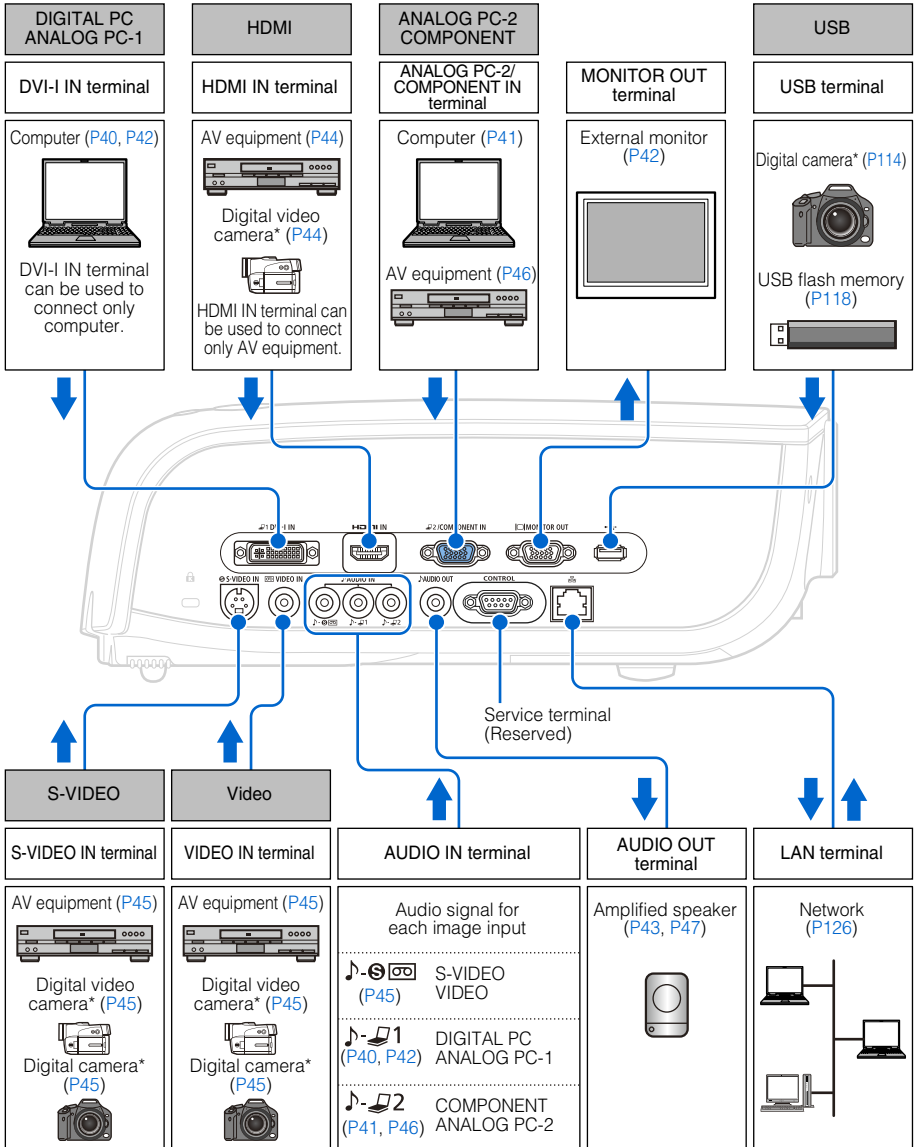

* Connect to the playback mode.

■ SX800

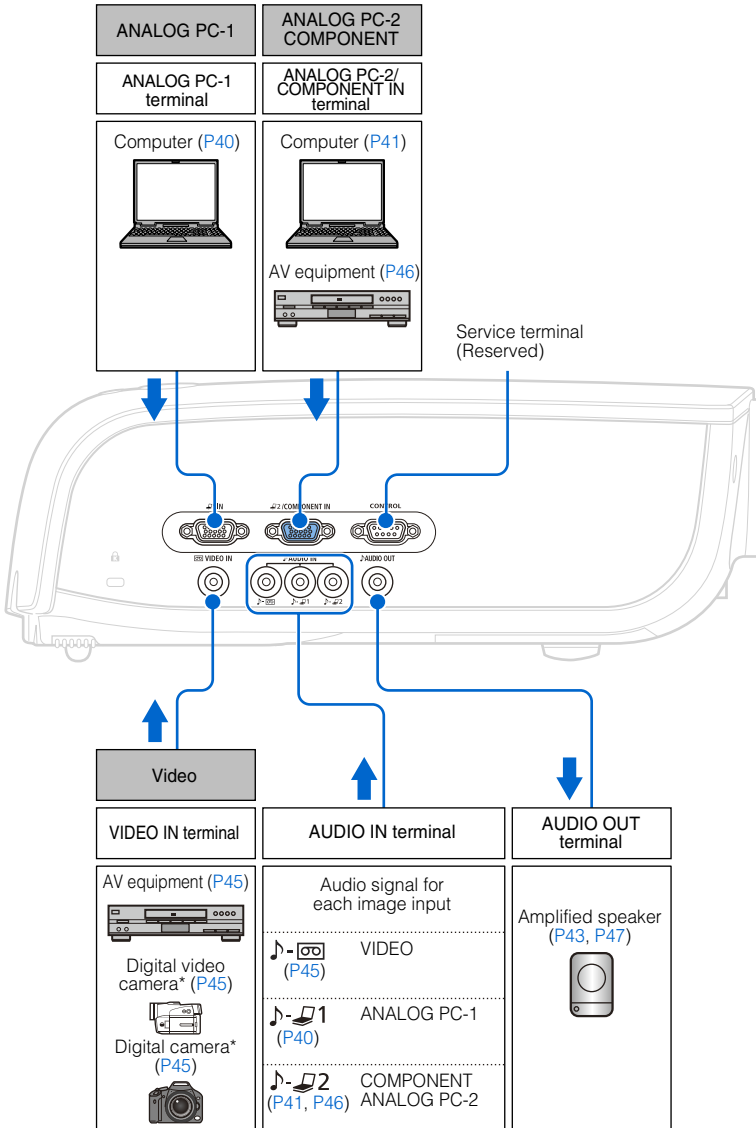

* Connect to the playback mode.

Connecting the Projector to the Computer

Connect the projector to the computer.

Before connecting the cables, turn off both the projector and computer.

■ Connecting to RGB Monitor Output Terminal (analog connection)

Supplied computer connection cable (Input signal type: [ANALOG PC-1] - P54)

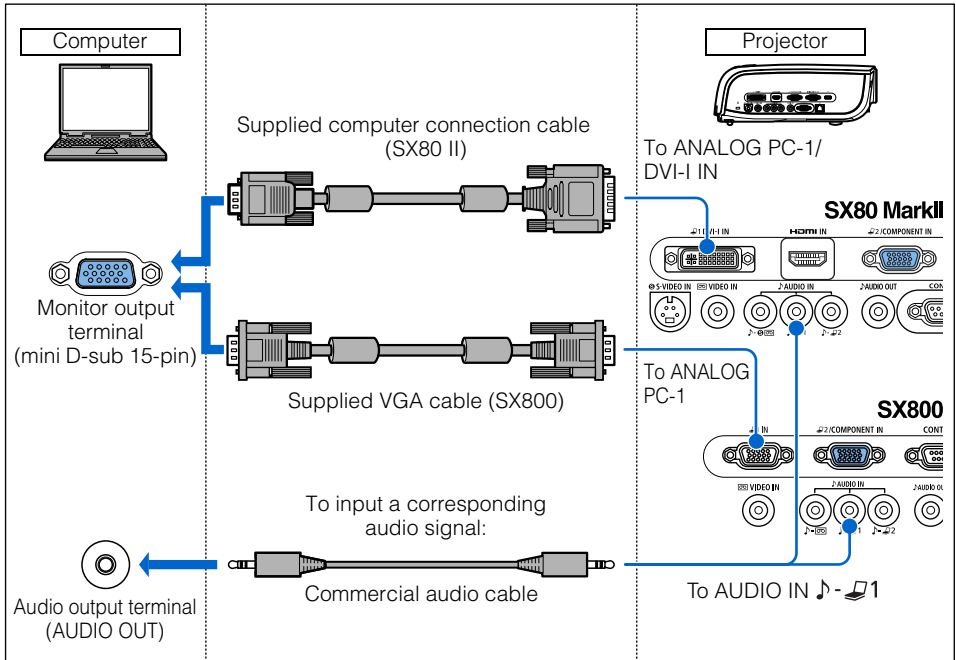

Use an audio cable without a built-in resistor. Using an audio cable with a built-in resistor turns down the sound.

Commercial or supplied VGA cable (Input signal type: [ANALOG PC-2] - P54)

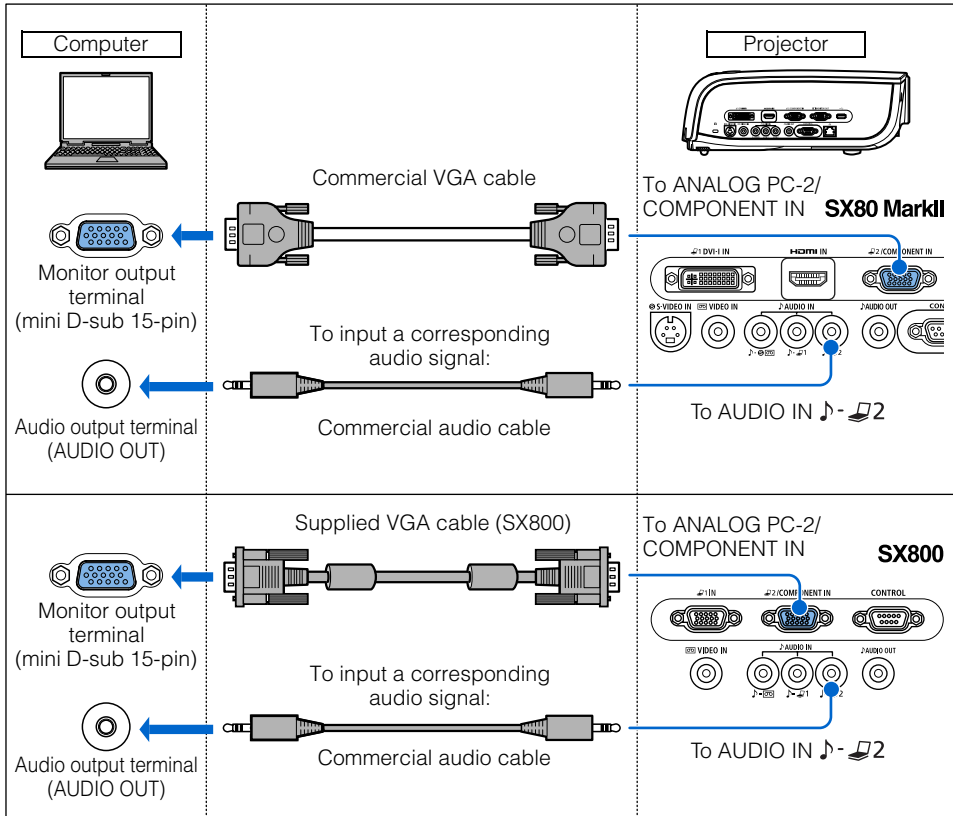

Projecting an Image

- If you use a commercial VGA cable, make sure to use a full connected VGA cable in which all pins are connected; otherwise, an image may be projected improperly.
- Use an audio cable without a built-in resistor. Using an audio cable with a built-in resistor turns down the sound.

■ Connecting to DVI Monitor Output Terminal (digital connection) (SX80 II)

DVI cable (Input signal type: [DIGITAL PC] - P54)

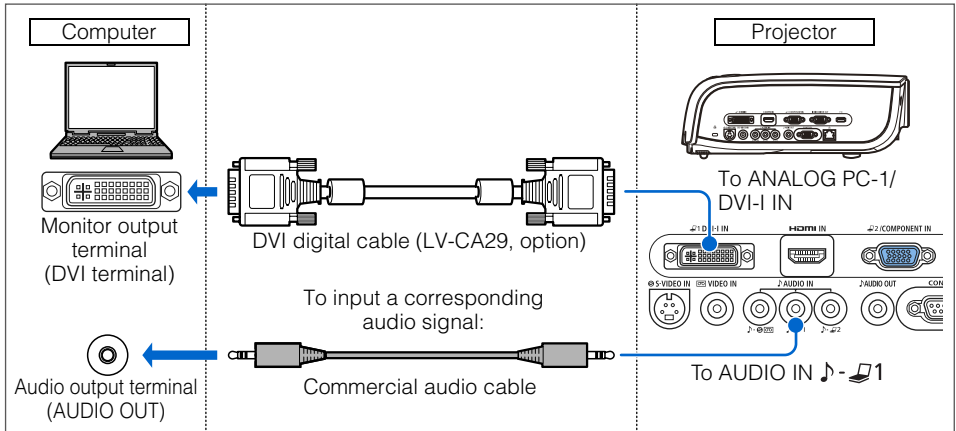

Use an audio cable without a built-in resistor. Using an audio cable with a built-in resistor turns down the sound.

■ Outputting an Image and Audio

Outputting an Image (SX80 II)

Images can be output to an external monitor via [ANALOG PC-1], [ANALOG PC-2] and [COMPONENT].

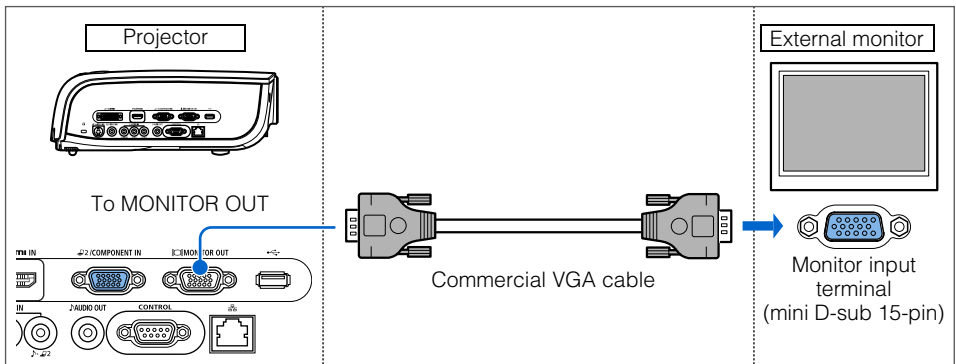

- You can connect one external monitor.
- It outputs an image of the analog PC or component video signal, whichever was previously selected

Outputting Audio to Speakers

It is possible to output sound of projected images to AV equipment or amplified speakers.

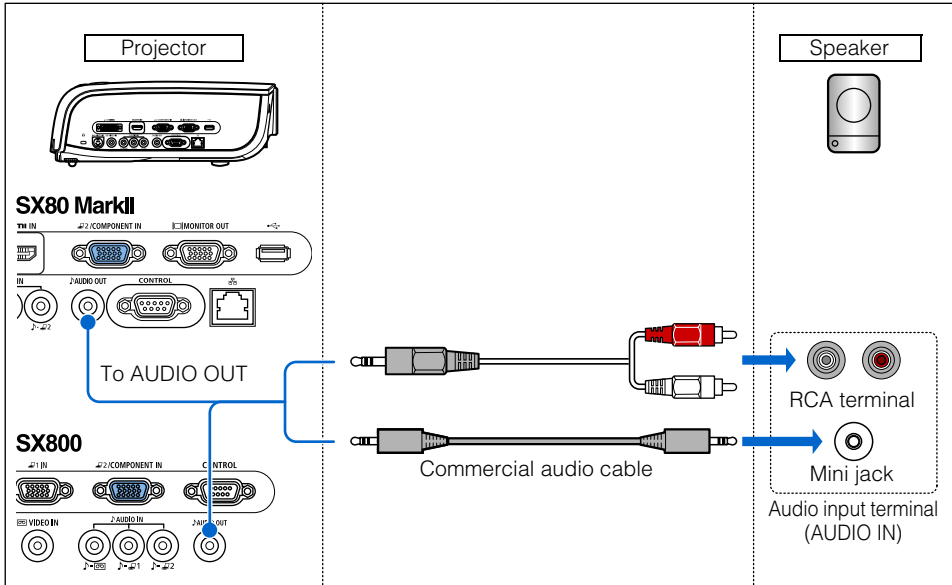

- The speaker outputs the audio signal corresponding to the selected image signal.
- Use an audio cable without a built-in resistor. Using an audio cable with a built-in resistor turns down the sound.

Connecting to AV Equipment

Connect the projector and AV equipment.

Before connecting the cables, turn off both the projector and AV equipment.

The description provided here is just examples. For more detailed information, refer to the manual for the connecting AV equipment.

■ Connecting to Digital Video Output Terminal (digital connection) (SX80 II)

HDMI cable (Input signal type: [HDMI] - P54)

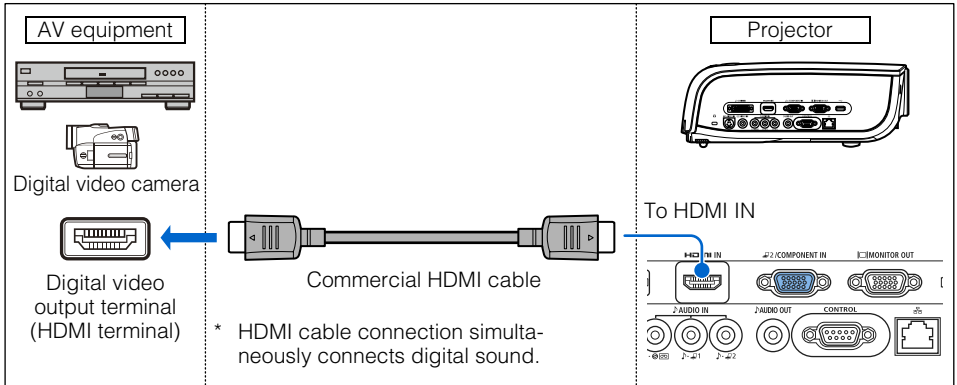

■ Connecting to Analog Video Output Terminal (analog connection)

Video cable (Input signal type: [VIDEO] or [S-VIDEO] - P54)

Connect the projector and AV equipment using a video or S-VIDEO cable that fits to the terminal type of the AV equipment.

The input signal type is [VIDEO] or [S-VIDEO].

Sound is common to [VIDEO] and [S-VIDEO].

[S-VIDEO] is supported only in SX80 MarkII.

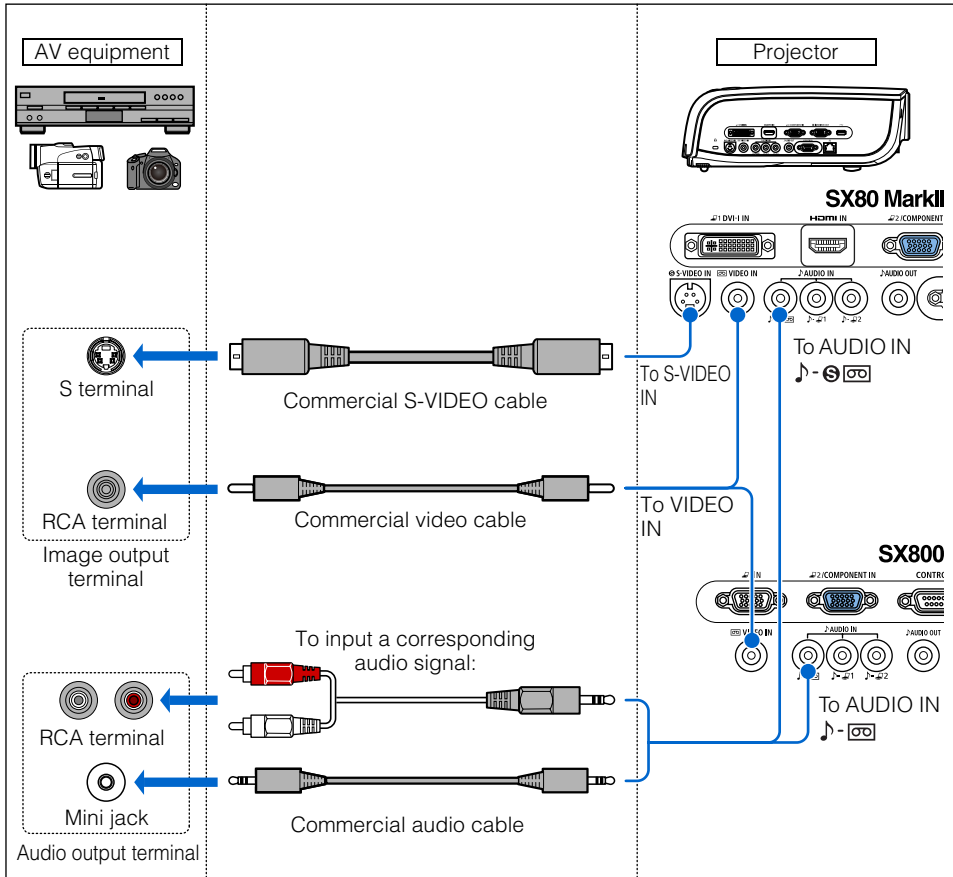

Projecting an Image



Use an audio cable without a built-in resistor. Using an audio cable with a built-in resistor turns down the sound.

Connecting the Projector

Supplied component cable (Input signal type: [COMPONENT] - P54)

A Component video signal from AV equipment can be input to the projector by connecting the supplied component cable to the ANALOG PC-2/COMPONENT IN terminal of the projector.

Use a commercial component cable that fits to the terminal type of the AV equipment to connect the supplied component cable.

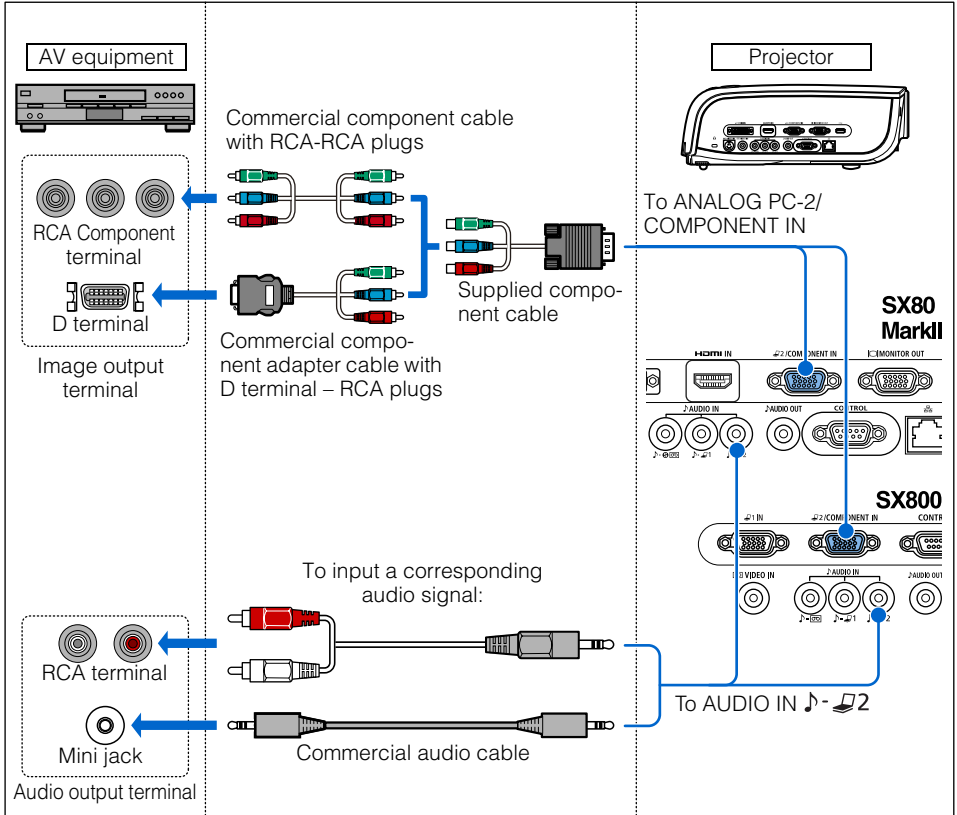

Use an audio cable without a built-in resistor. Using an audio cable with a built-in resistor turns down the sound.

■ Outputting Audio to Speakers

It is possible to output sound of projected images to AV equipment or amplified speakers.

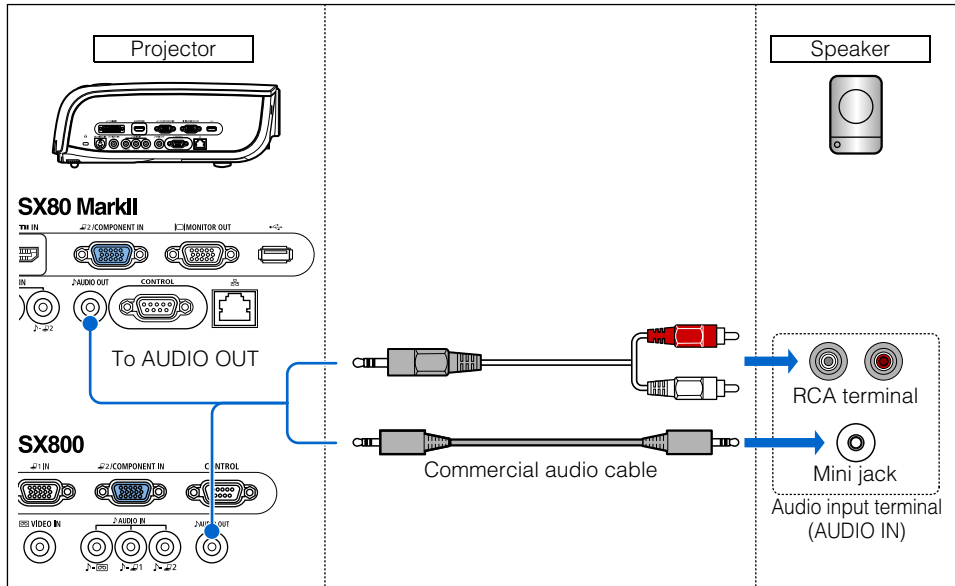

Use an audio cable without a built-in resistor. Using an audio cable with a built-in resistor turns down the sound.

■ Connecting a Digital Camera or an USB Flash Memory (SX80 II)

SX80 MarkII supports PictBridge.

You can connect a PictBridge enabled digital camera, a digital video camera, an USB flash memory, or an USB memory card reader to directly project images.

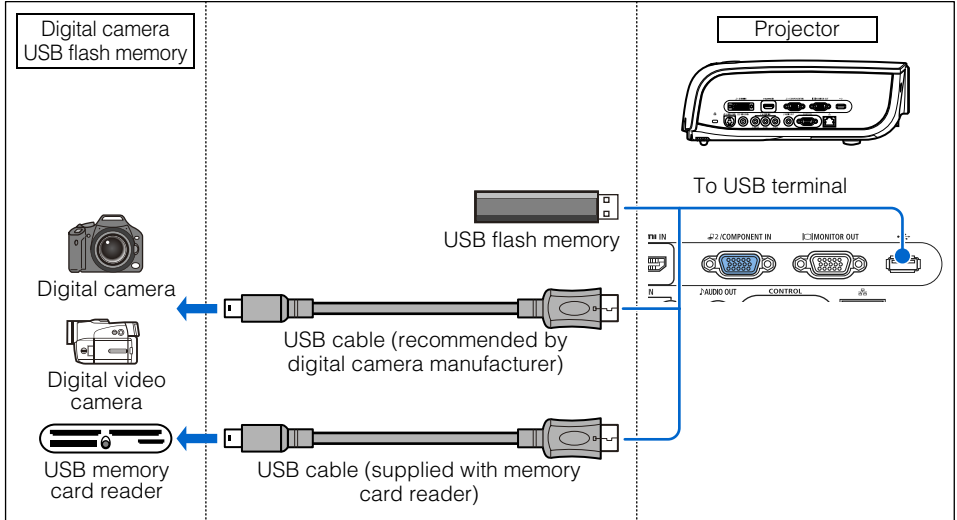

Starting Projection

- 1 Check the connection between the projector and a computer or AV equipment. (P38 – P48)
- 2 Connect the power cord and make sure that the [POWER] indicator lights up red. Flashing red [POWER] indicator indicates that the lamp is being cooled. Wait until the indicator turns a steady red.

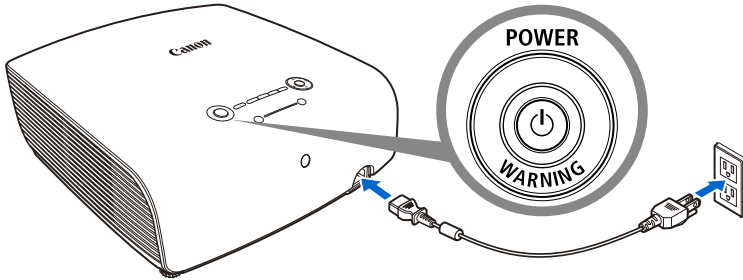

- Fully insert the power cord plug into the socket.
 - Connect the ground terminal on the power plug to ground. Otherwise, an electric shock may result or the computer may suffer electromagnetic radiation problems or be subject to poor reception by TV and radio.
 - Wait at least 5 minutes before turning on the projector when you turn off the projector. It may shorten the lamp life if you turn on the projector immediately after turning it off.
 - To save power, unplug the power cord when not in use.
- 3 Remove the lens cap and press the POWER button. The POWER indicator flashes green, and then lights in green.

Remote control

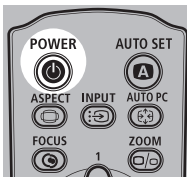

Top control

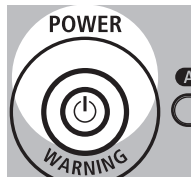

The countdown window is displayed for approximately 20 seconds, and then the projection is started. Press the **OK** button to make the countdown window disappear.

- 4 Turn on the computer or AV equipment power.

Changing Operations When Projector is Turned On

You can change operations when the projector is turned on as follows:

- You can turn on the projector by connecting the power cord without pressing the **POWER** button. (P104)
- You can specify whether to enable or disable the LED illumination lamp. (P106)
- You can change the countdown window. (P90)
- You can skip the countdown window. (P49)

Using the Power Saving Mode (power management)

When you enable the power management mode, the lamp is automatically turned off if the projector receives no signal input for a certain period of time. (P103)

5 Press the AUTO SET button.

The auto setup function performs the following operations automatically:
 SX80 MarkII: focusing and keystone distortion adjustment, input signal setting, and screen color correction

SX800: keystone distortion adjustment and input signal setting

For more details, refer to the page 52.

If the projector is projecting an image properly with [AUTO SETUP], the projection is complete.

In SX800, adjust the focus and correct the screen color manually.

For how to turn off the projector, refer to the page 68. Perform the appropriate operation depending on the following situations.

■ When the Language Selection Screen Appears

A window appears when the projector is turned on for the first time. You can select a language to be used by the projector for displaying menus and messages in the window.

Select the desired language with the pointer buttons and press the **OK** button.

You can change the language from the menu at a later time. (P105)

If you cannot check the language selection screen due to the out of focus, press the **FOCUS** button to adjust the focus. (P59)

Remote control

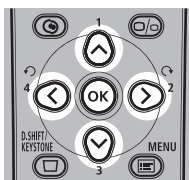

Top control

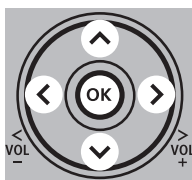

Language		
English	Русский	Čeština
Deutsch	Nederlands	Dansk
Français	Suomi	إنجليزي
Italiano	Norsk	中文简体
Español	Türkçe	中文繁體
Português	Polski	한국어
Svenska	Magyar	日本語

An item highlighted in orange will be selected.

■ When the Password Input Screen Appears

If you have set a password, the Password input screen appears. Enter your password. (P108)

■ When "No signal" Appears

A notebook computer requires to turn on the external monitor output. (P51)
Press the **INPUT** button to select an appropriate input signal. (P55)

■ When Notebook Computer Screen Does Not Appear

Set your notebook computer to output signals to an external monitor. For more details, refer to "Changing Notebook Computer Screen Output" below.

■ Adjusting Image

- For the display resolution of the computer, select "1400 x 1050 pixels" or a resolution closest to the output signal resolution of the computer. (P56)
- Use the auto PC function to adjust shift in computer image or the flickering of the screen. (P57)
- Use the **ZOOM** button to adjust the size of the projecting image. (P58)
- Use the **FOCUS** button to correct the focus adjustment if necessary. (P59)
- Use the **D.SHIFT/KEYSTONE** button to adjust keystone correction if necessary. (P60)
- Select the aspect ratio of the projecting image (screen aspect) or a screen mode (aspect) according to the aspect ratio of the screen, type of input image signal and so on. (P62 - P66)
- Select an image mode depending on the projecting image. (P67)

Changing Notebook Computer Screen Output

To use a notebook computer, you need to change the screen output on the notebook computer.

This operation is not required for a desktop computer.

■ Turning On External Monitor Output

You can turn on the external monitor output via keyboard operation.

To turn on the external monitor output, press an icon for an external monitor or a function key ([F1] to [F12]) while holding [Fn] key down.

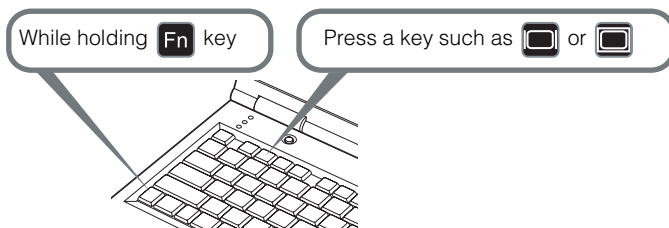

The function keys you use and the method used to turn on the external monitor output vary depending on the model. For details, see the instructions of your notebook computer.

Setting Up the Screen Automatically

Auto Setup

The auto setup function automatically makes the following settings and adjustments.

Setting image input signal (Auto input)

Focusing (Auto focus) (SX80 II)

Keystone correction (Auto keystone)

Screen color correction (Auto screen color correction)
(SX80 II)

Use the auto setup function when:

- You turned the power on and the countdown sequence was completed.
- You changed the position or angle of the projector during the projection process.



- The auto screen color correction is disabled at the factory. To enable the auto screen color correction when performing the auto setup, select the function in menu. (SX80 II) (P86)
- You cannot set a digital PC signal or an AV equipment signal ([Digital PC] and [HDMI]) with the auto setup function. Select the appropriate signal by pressing the **INPUT** button. (SX80 II) (P55)
- When "No signal" message appears, press the **INPUT** button to select an appropriate input signal. (P55)
- If focusing, keystone distortion and/or screen color correction have not been performed properly, manually adjust them. (Adjusting the focus: P59, Correcting keystone distortion: P60 and Correcting the screen color: P86)
- In SX800, the auto setup function does not adjust the focus. Please manually adjust the focus. (P59)
- If you select [16:9 D. image shift] for [Screen aspect], [Auto setup] will be disabled and the following screen appears.

SX80 MarkII

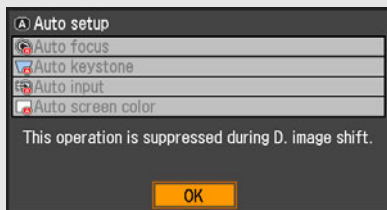

SX800

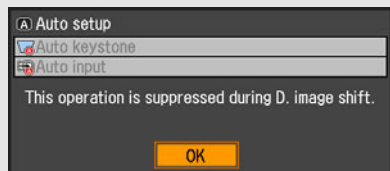

- When you press the **INPUT** button and then the **AUTO SET** button, only the input signal type is set.
- When you press the **FOCUS** button and then the **AUTO SET** button, only the focus is adjusted. (SX80 II)
If you select [16:9 D. image shift] for [Screen aspect], the auto focus function will be disabled.
- When you press the **D.SHIFT/KEYSTONE** button and then the **AUTO SET** button, only the keystone distortion is adjusted. If you select [16:9 D. image shift] for [Screen aspect], the keystone adjustment will be disabled.

■ Performing the Auto Setup

Press the **AUTO SET** button to perform the auto setup.

Remote control

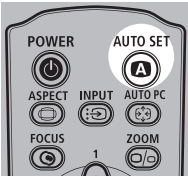

Top control

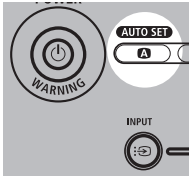

- After the auto setup is complete, the following window appears. Press the **OK** button.

SX80 MarkII

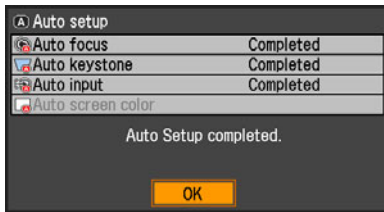

SX800

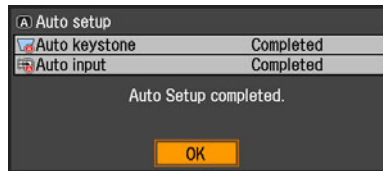











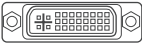
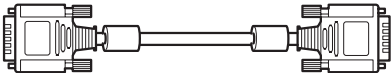

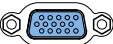
Selecting an Input Signal (INPUT)

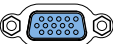
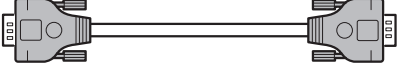
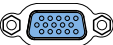
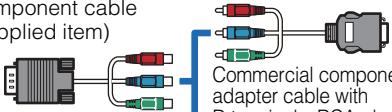
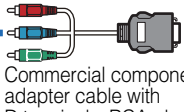
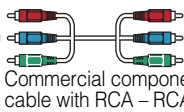
Select an appropriate input signal in the [INPUT] menu if you want to project a digital PC or AV equipment signal or you connect multiple computers or AV equipment to receive their input signals. Skip this step if you have not changed the input signal since the last projection.

Types of Input Signals

The table below shows the relationship among input signals supported by the projector, input terminals and connection cables.

Input signal	Supported model	Input terminal	Types of connection cables
HDMI	SX80 II	HDMI IN 	HDMI cable (commercial item) 
DIGITAL PC	SX80 II	ANALOG PC-1/ DVI-I IN 	DVI digital cable (LV-CA29, option) 
ANALOG PC-1	SX80 II	ANALOG PC-1/ DVI-I IN 	Computer connection cable (supplied item) 
	SX800	ANALOG PC-1 	VGA cable (supplied item) 
ANALOG PC-2	SX80 II SX800	ANALOG PC-2/ COMPONENT IN 	VGA cable (commercial item) 
COMPONENT	SX80 II SX800	ANALOG PC-2/ COMPONENT IN 	Component cable (supplied item)  Commercial component adapter cable with D terminal – RCA plugs  Commercial component cable with RCA – RCA plugs 
VIDEO	SX80 II SX800	VIDEO IN 	Video cable (commercial item) 
S-VIDEO	SX80 II	S-VIDEO IN 	S-VIDEO cable (commercial item) 
USB	SX80 II	USB 	USB cable or USB flash memory (commercial item)

■ Selecting an Input Signal

1 Press the INPUT button to pop up a window shown at the lower right.

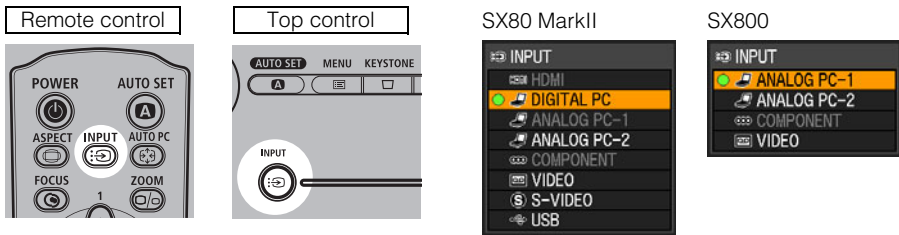

The currently active input signal is marked with a circle and highlighted in orange. An input signal that is ready for projection is displayed in white. When no signal is received, it is displayed in gray.

In SX80 MarkII, [HDMI], [DIGITAL PC], and [ANALOG PC-1] may be displayed in gray even if they are ready for projection.



When you select [USB] with no PictBridge enabled equipment or a USB flash memory connected and pressing the OK button, a window waiting for you to connect a PictBridge enabled equipment or a USB flash memory appears. For more details, refer to "Projecting an Image from a Digital Camera (SX80 II)" (P114 – P117) or "Projecting Data on USB Flash Memory (SX80 II)" (P118 – P124).

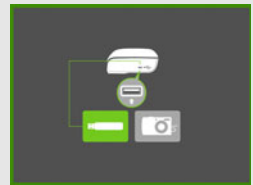

2 The selection is toggled through available input signal types by pressing the INPUT button.

- You can select the target input signal with [\wedge] / [\vee].
- Only the input signals displayed in white can be selected.

3 Press the OK button to determine the input signal type.

If no button is pressed in 4 seconds, the selected input signal type is chosen.

Adjusting Image

Setting the Display Resolution of the Computer

Set the display resolution of the computer to "1400 x 1050 pixels" or a resolution closest to the output signal resolution of the computer based on the performance of the projector (resolution: 1400 x 1050 pixels). (P150)

■ Windows Vista

- 1 Open the [Control Panel] from the start menu, then select [Appearance and Personalization] - [Adjust screen resolution] in the [Control Panel Home].
- 2 Select "1400 x 1050 pixels" or a resolution closest to the output signal resolution of the computer.
- 3 Click the OK button.

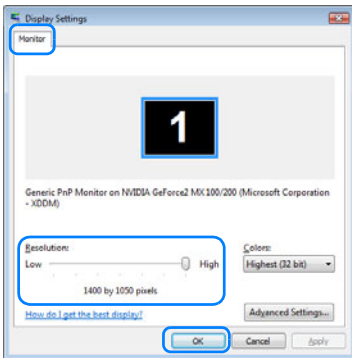

■ Windows XP

- 1 Right-click on the desktop background and select [Properties] to open the [Display Properties].
- 2 Click the [Settings] tab, and under [Screen Resolution], select "1400 x 1050 pixels" or a resolution closest to the output signal resolution of the computer.
- 3 Click the OK button.

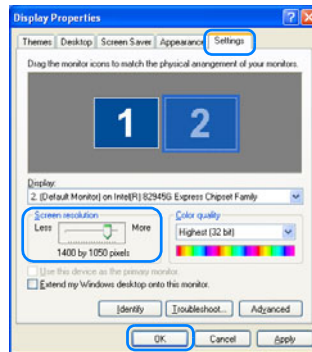

■ Macintosh OSX

- 1 Open the Apple Menu and select [System Environment Setting].
- 2 In the System Environment Setting window, click the [Displays] icon to display the Display window.
- 3 Select the [Display] tab and select "1400 x 1050" or a resolution closest to the output signal resolution of the computer from the [Resolution] list.
- 4 Close [System Environment Setting] window.

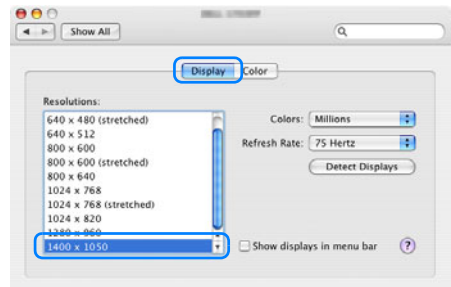

AUTO PC

When you press the **AUTO PC** button if there is a shift in image display or flickering of screen with the [ANALOG PC-1] or [ANALOG PC-2] selected, the projector is adjusted to an optimum condition.

The result of adjustment is recorded for each input signal ([ANALOG PC-1] or [ANALOG PC-2]). If you connect the projector to the same computer, you can project the image with the same settings as before simply by select the input signal.

■ Performing the Auto PC Function

Press the **AUTO PC** button to make projector adjustment.

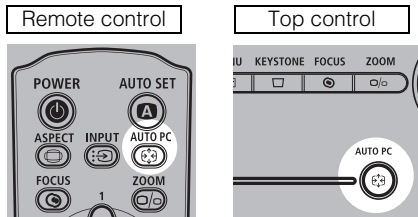

Perform the following if the project image has not been properly adjusted with the auto PC function.

- From [Input signal select], select an input signal type based on the resolution of the computer. (P80)
- If the adjustment is still insufficient, from [Input signal settings] select [Total dots], [Tracking], [Horizontal position], [Vertical position], [Horizontal pixels] and [Vertical pixels] to make adjustments. (P81 – P84)
- For the signal types supported by the projector, see the table on page 150.

Adjusting the Image Size

Use the **ZOOM** button to adjust the size of the projecting image.
 Change the projector installation position if your desired image is too large or too small to adjust it with the zoom function. (P35)

- 1 Press the **ZOOM** button to pop up a window shown at the lower right.

Remote control

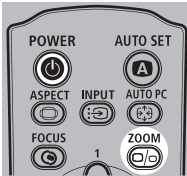

Top control

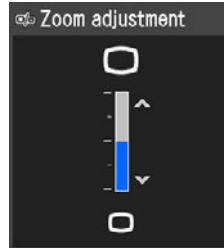
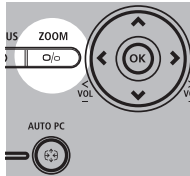

- 2 Press the pointer buttons to adjust the image size.

Remote control



Top control

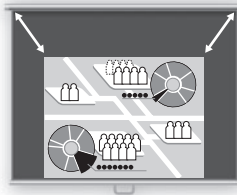
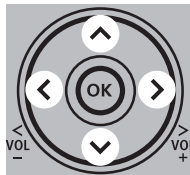

[^] / [v]: Rough adjustment.
 [<] / [>]: Fine adjustment.

- 3 When the image size is determined, press the **OK** button or the **ZOOM** button.

Adjusting the Focus

You can adjust the focus with the **FOCUS** button. The projection image may be out of focus if the projection distance is beyond the range of 1.2 m (3.9') to 9.1 m (29.6'). Move the projector installation position if such is the case. (P35)

■ Auto focusing (SX80 II)

Press the **FOCUS** button, and then the **AUTO SET** button.



If you select [16:9 D. image shift] for [Screen aspect], the auto focus function will be disabled.

■ Manual focusing

- 1 Press the **FOCUS** button to pop up a window shown at the lower right.

Remote control

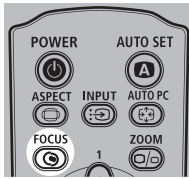

Top control

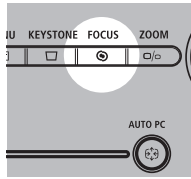

Focus adjustment

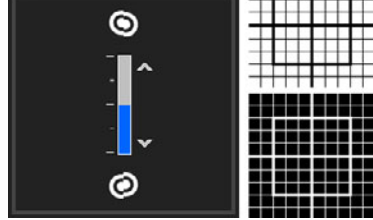

- 2 Press the pointer buttons to adjust the focus.

Remote control

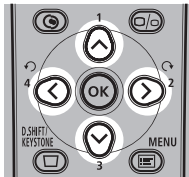

Top control

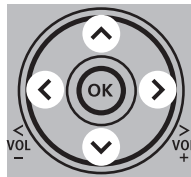

[\wedge] / [\vee]: Rough adjustment.

[<] / [>]: Fine adjustment.

- 3 When the focus is adjusted optimally, press the **OK** button or the **FOCUS** button.

Adjusting Keystone Distortion

The D.SHIFT/KEYSTONE button corrects the keystone distortion.



- Keystone can be adjusted within the range of ± 20 degrees. If the keystone distortion is too large to adjust, move the projector installation position. (P35)
- The amount of adjustment may be smaller depending on type of input signal.
- The result of keystone adjustment is memorized. If you place the projector at the same position, the keystone adjustment is not necessary.
- Signals are processed digitally when keystone distortion is corrected. The image may look different from the original one. In addition, the aspect ratio of the image may change.
- If you select [16:9 D. image shift] for [Screen aspect], the keystone adjustment will be disabled. Project the image at right angle to the screen.

■ Auto adjustment

Press the D.SHIFT/KEYSTONE button, and then the AUTO SET button.

■ Manual adjustment

1 Press the D.SHIFT/KEYSTONE button to pop up a window shown at the lower right.

Remote control

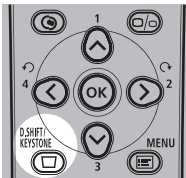

Top control

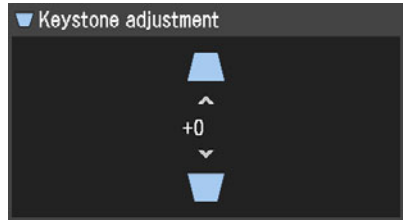
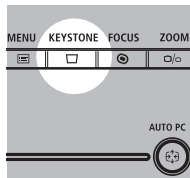

2 Press the pointer buttons to adjust the focus.

Remote control

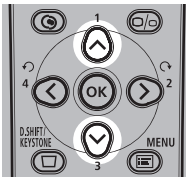

Top control

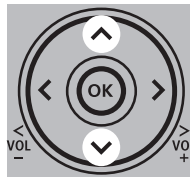

[\wedge]: Reduces the length of the upper edge.

[\vee]: Reduces the length of the lower edge.

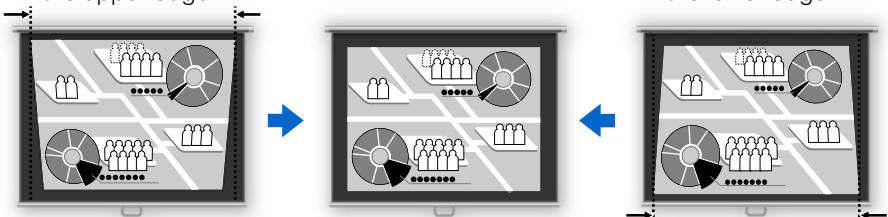

3 When the keystone distortion has been adjusted, press the OK button.

■ Resetting the Keystone Adjustment

Perform the following steps to reset the keystone adjustment.

Press the **D.SHIFT/KEystone** button twice to display the [Keystone reset] window.

On the window, select [OK] with [**<**], and then press the **OK** button.

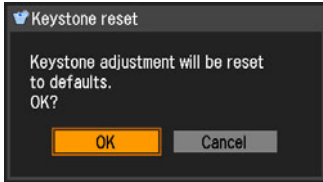

Selecting Screen Aspect and Aspect

Select an optimum aspect ratio of the projecting image (screen aspect) or an optimum screen mode (aspect) according to the aspect ratio of the screen, type of input image signal and so on for the projection making best use of the screen size.

- [Screen aspect]: Select the same aspect ratio with your screen.
- [Aspect]: Select [Auto] unless the type of input signal is [VIDEO].

You may need to change the setting depending on the resolution of the computer. If the image is not projected with a desired aspect ratio, see "Relationship between Aspect and Screen Aspect" in Appendix on page 147.

Selecting Screen Aspect

Select the aspect ratio of projecting image to the aspect ratio of the screen.
Perform the following steps to select the aspect ratio of the projecting image.

1 Press the MENU button to display a menu window.

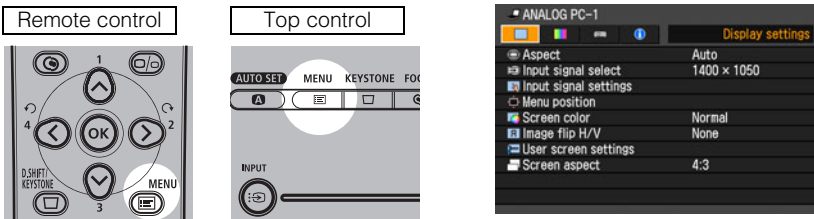

2 Use [←] / [→] to select the [Display settings] tab.

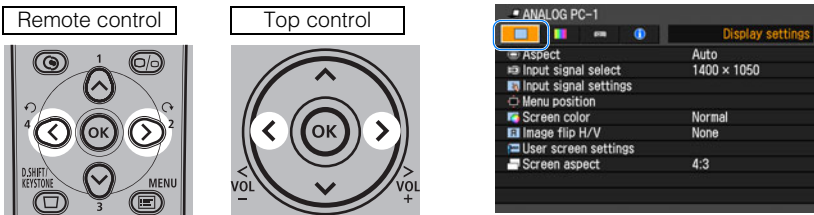

3 Select [Screen aspect] with [↑] / [↓], and then press the OK button.

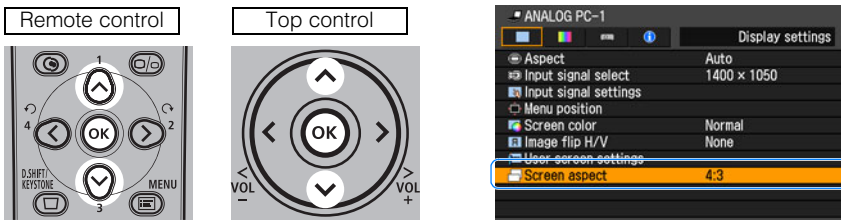

4 Use [\wedge] / [\vee] to select a screen aspect type.

Remote control

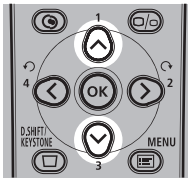

Top control

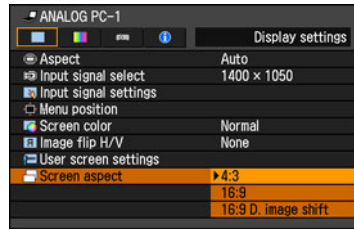
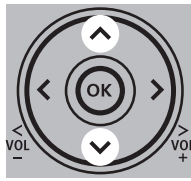

4:3

Select this when you use a screen with aspect ratio of 4:3.

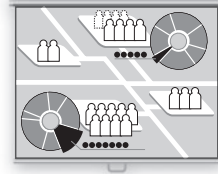

16:9

Select this when you use a screen with aspect ratio of 16:9.

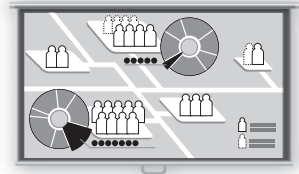

16:9 D. image shift

Select this when you use a screen with aspect ratio of 16:9. Suitable for projecting visual software having aspect ratio of 16:9.

You cannot correct the keystone distortion in this mode, but you can move the image up or down with images being projected horizontally.

See the following page on how to shift the image.



5 Press the OK button to accept your setting and then press the MENU button.

■ Moving Image with 16:9 D. Image Shift

1 Press the D.SHIFT/KEYSTONE button to pop up a window shown at the lower right.

Remote control

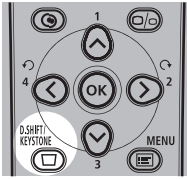

Top control

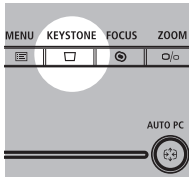

2 Use [\wedge] / [\vee] to move the image.

Remote control

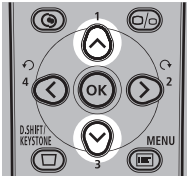

Top control

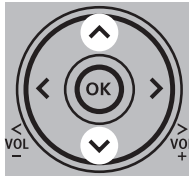

[\wedge]: Moves up the image.

[\vee]: Moves down the image.



3 When the image shift adjustment has been completed, press the OK button.

■ Resetting the Image Shift

Perform the following steps to reset the image shift adjustment.

Press the D.SHIFT/KEYSTONE button twice to display the [D.Image Shift reset] window.

On the window, select [OK] with [\leftarrow], and then press the OK button.

Selecting Aspect Ratio

Select the aspect ratio of projecting image based on the input signal type, aspect ratio of the screen and resolution.

For more details on the aspect ratios, refer to "When Projecting an Image from a Computer" on page 147.

■ Types of Aspect Ratios

Auto

An image is projected at an aspect ratio of the input signal. Select this mode for normal image projection.



- [Auto] is not available if the input signal type is [VIDEO].
- [Auto] is automatically selected if the input signal type is [USB]. (SX80 II)

4:3

An image is projected at an aspect ratio of 4:3. Select this if an image of 4:3 aspect ratio cannot be appropriately projected in the [AUTO] mode.

16:9

An image is projected at an aspect ratio of 16:9. Select this if an image of 16:9 aspect ratio cannot be appropriately projected in the [AUTO] mode.

Zoom

An image with 4:3 aspect ratio is projected in the center of the screen enlarged in 16:9 aspect ratio with the upper and lower portion of the image cut off. Select this when projecting visual software having aspect ratio of 4:3 and black belts at the top and bottom of the image.

- This mode is available when you select [16:9] or [16:9 D. image shift] for [Screen aspect] and select [HDMI (576p, 480p) (SX80 II)], [COMPONENT (576p, 480p, 576i, 480i)], [VIDEO] or [S-VIDEO (SX80 II)] for input signal.

True size

An image is projected with the original resolution of the input signal. Select this to clearly project computer screen images having a resolution SXGA+ or lower (VGA, SVGA, XGA or SXGA) or visual software having a resolution lower than 1035i.

- This mode is available when you select [HDMI (720p, 576p, 480p) (SX80 II)] or [COMPONENT (720p, 576p, 480p)] for input signal.



- It is not available for an image having a resolution higher than SXGA+ or visual software having a resolution of 1080i, 1080p, 1035i, 576i or 480i.
- It is also available if the input signal is [ANALOG PC-1], [ANALOG PC-2], or [DIGITAL PC (SX80 II)]; however, it may not be available depending on the screen aspect setting.

■ How to Select an Aspect Ratio

Press the **ASPECT** button on the remote control to select an appropriate aspect ratio. The selection is toggled among types for aspect ratios by pressing the **ASPECT** button.

For more details on the aspect ratios, refer to "When Projecting an Image from a Computer" on page 147.

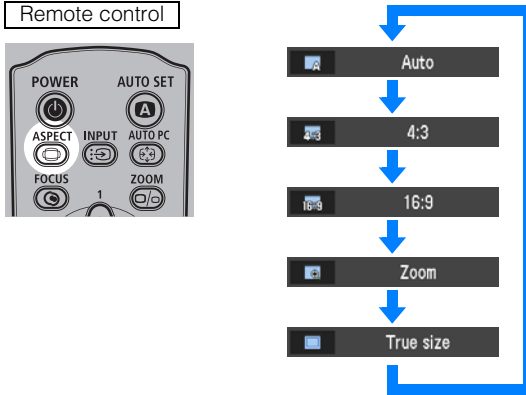

You can also select any aspect ratio from the menu. (P79)



Some aspect ratios may not appear depending on types of input signals.

Selecting an Image Mode

You can select an image mode depending on the projecting image. In each image mode, you can further adjust the brightness, contrast, sharpness, gamma, color adjustment, advanced adjustment, and lamp mode. (P93)

■ Image modes

Standard

Select this to project an image with near-original quality and a high regard for reproduction of white. It is suited to project text-based computer screens or visual software (moving pictures) in a bright room.

Presentation

Select this to project an image with quality suited for the presentation. It is also suited to project visual software (moving pictures) with a high regard for the brightness.

Movie

Select this to project common visual software (moving pictures). It is suited to easily enjoy the atmosphere of a moving theater in a dim room.

sRGB

Select this if you want to project an image in the display mode conforming to the sRGB standard (P152). It is suited to project an image shot by sRGB-compatible digital camera.

Photo (SX80 II)

If you select [Photo] for [Image mode], make sure to set [Ambient light] in the [Image adjustment] as well.

You can correct an image according to the ambient light based on [sRGB] in [Image mode] and project the image with higher tone on the screen by setting [Ambient light]. It is suited to project an ornamental photo, etc. under an ambient light.

It is available if the input signal is [ANALOG PC-1], [ANALOG PC-2], [DIGITAL PC], or [USB].

■ How to Select an Image Mode

Press the **IMAGE** button on the remote control to select your desired image mode. The selection is toggled among aspect types by pressing the button.

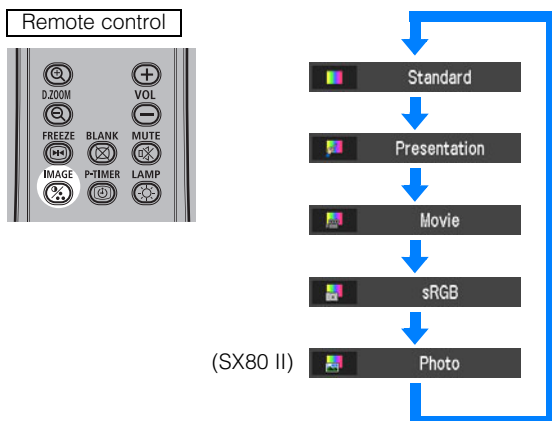

(SX80 II)

You can also select any image mode from the [Image mode] menu. (P93)

Turning Off the Projector

1 Press the **POWER** button to pop up a window shown at the lower right.

Remote control

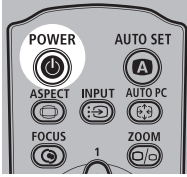

Top control

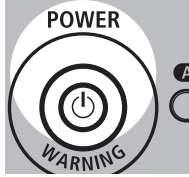

Press the **POWER** button again while the confirmation message is displayed. The lamp goes off, the [POWER] indicator starts flashing in red and the cooling fan starts.



- You cannot turn the projector on while the cooling fan is in operation.
- If you want to continue projecting, press a button other than **POWER** or wait until the confirmation message disappears.
- Wait at least 5 minutes before turning on the projector when you turn off the projector. It may shorten the lamp life if you turn on the projector immediately after turning it off.
- Using the projector for a long time may shorten the life of the lamp and internal optical components.

2 Remove the power cord from the AC outlet.

It continues to cool down the lamp even after removing the power cord. Thus, you may move or put away the projector immediately after the use.

With the power cord connected, the LED illumination lamp turns on during cooling cycle.

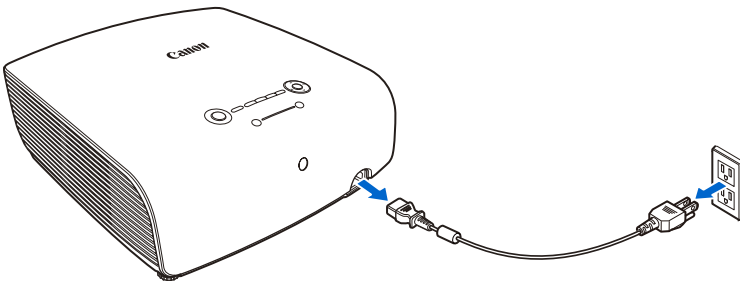

- Wait until the cooling fan stops before putting the projector in the carrying bag. Do not put the projector in the carrying bag until the cooling fan stops rotating. The projector may be damaged due to the heat.
- Attach the lens cap to the lens to protect it and put the projector in the carrying bag. Replace the adjustable foot to prevent the damage on the projector.

Useful Functions Available During a Presentation

Table of Contents

Safety Instructions

Before Use

Projecting an Image

Useful Functions Available During a Presentation

Setting Up Functions from Menus

Projecting an Image from a Digital Camera or an USB Flash Memory (SX80 II)

Connecting the Projector to Network (SX80 II)

Appendix

Index

Useful Functions Available During a Presentation

Blackened Out an Image Temporarily





Useful when:

- You finished the presentation.
- You want to divert attendees' attention from the screen.

Remote control



Press the  button to blacken out the image.

Press the  button again to show the image.

- You can set the screen state while blackening out the image on the menu. You can also set a specified image. (P89)
- The lamp keeps a turn-on state while blackening out the image.
- The (middle) LED illumination lamp on the top control flushes slowly while blackening out the image.

Freezing the Picture



Useful when:

- You want to perform a computer operation which is irrelevant to the proceedings of the presentation.
- You want to stop a moving image.

Remote control

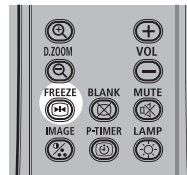

Press the  button to freeze the moving image. The projector shows the following icon.

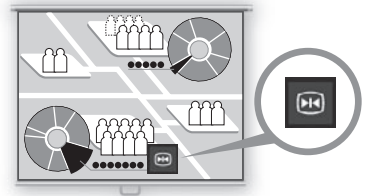

Press the  button again to cancel the FREEZE function.

- The (left and right) LED illumination lamps on the top control flushes slowly while stopping the image.
- It is cancelled once the input signal is terminated.
- You cannot zoom an image (P72) when you are freezing the image.

Adjusting the Volume



Useful when:

- You want to adjust the volume level of the projectors or external speaker.

Remote control



Press the  button. The following screen appears.

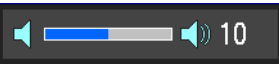

- You can also adjust the volume level with [$<$] / [$>$] of the projector.
- Adjust the volume or mute setting on the computer if the volume level is too low.
- You can also adjust the volume level of the speakers connected via the audio output terminal.

Muting the Sound



Useful when:

- You want to temporarily mute the unnecessary sound.
- You want to immediately mute the sound.

Remote control

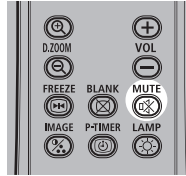

Press the  button to mute the sound. The projector shows the following icon.

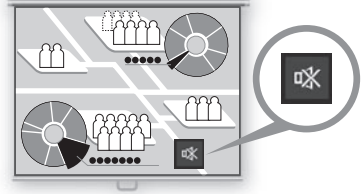

Press the  button again to cancel the MUTE function.

- You can also mute the sound of the speakers connected via the audio output terminal.

Zooming an Image



Useful when:

- Zoom in an object such as a small graph during a presentation (up to 12x).
- Focusing on the current subject.

Press the  button. A part of the image is enlarged each time pressed.

Remote control

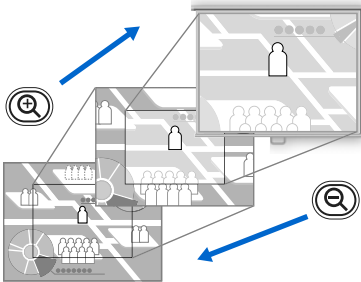

- The magnification appears on the screen.

You can move the area to the enlarged by using [\wedge] / [\vee] / [$<$] / [$>$].

Remote control

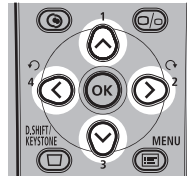

Projector

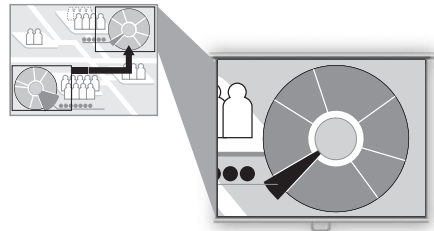
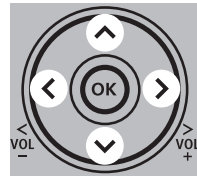

You can restore the original size of the image by pressing the  button.

Showing the Elapsed Time P-TIMER



Useful when:

- You want to manage the proceedings of the presentation.

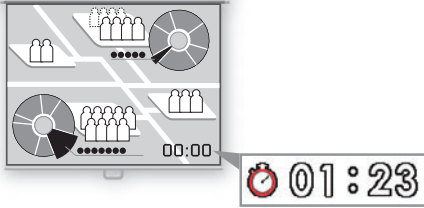



Press the  button to start counting.

- The elapsed time is displayed at the lower right corner of the screen.
- Time is counted up to 59:59. Then the timer returns to 00:00.

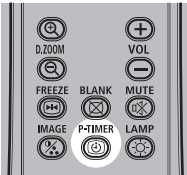
Remote control



Press the  button again to stop the timer.

- Press the  button while the timer is stopped. The timer disappears from the screen.

Then press the  button to start counting from 00:00.

Projecting Image Without Computer (SX80 II)

Useful when:

- You want to project an image from a digital camera.
- You want to project an image from USB flash memory.

You can project an image directly by connecting the projector with a PictBridge-compatible digital camera or USB flash memory.

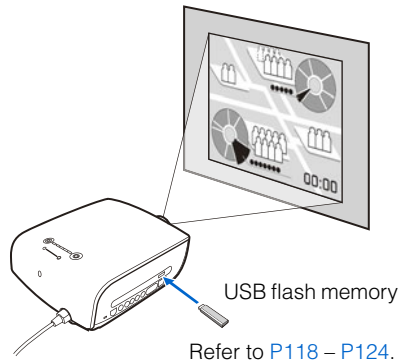
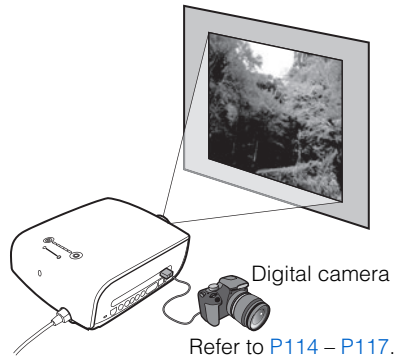

Setting Functions from Menus

Table of Contents

Safety Instructions

Before Use

Projecting an Image

Useful Functions Available During a Presentation

Setting Up Functions from Menus

Projecting an Image from a Digital Camera or an
USB Flash Memory (SX80 II)

Connecting the Projector to Network (SX80 II)

Appendix

Index

How to Use Menu

With a menu, you can set the operation of the projector in detail.

■ Menu Configuration

The menu screen is divided into four tabs as follows:

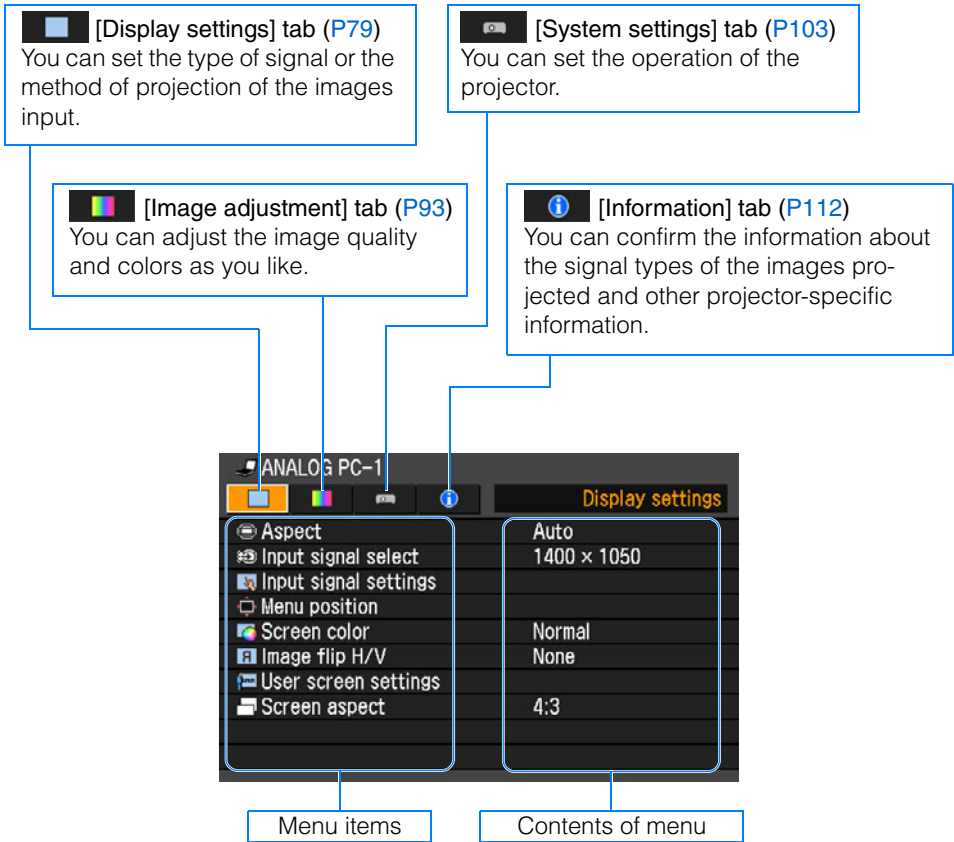

Input Signal Types for which a Menu Item is Displayed

Different menu items are displayed for different input signal types.

In the following explanation of each menu item, the input signal type for which the menu item is displayed is indicated as follows:

The following is for SX80 MarkII.

- Input signal for which the menu item is displayed
- Input signal for which the menu item is not displayed

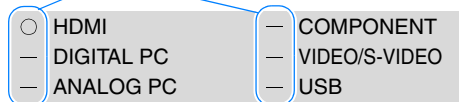

Basic Operation of Menu

1 Press the MENU button to display a menu window.

Remote control

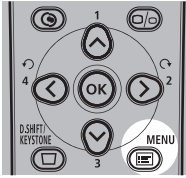

Top control

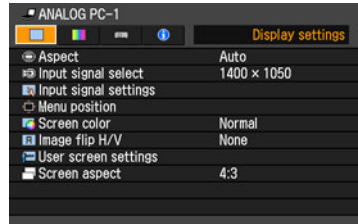
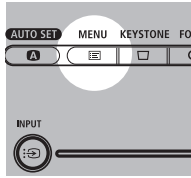

2 Use [<] / [>] to select a tab.

Remote control

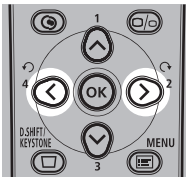

Top control

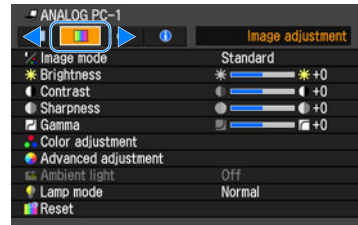
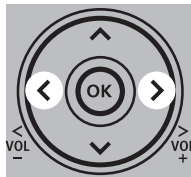

- If the tab position is not highlighted in orange, use [^] / [v] to move the highlight to the top.

3 Use [^] / [v] to select an item.

Remote control

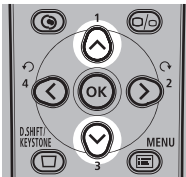

Top control

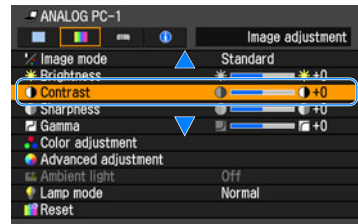
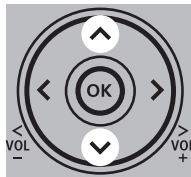

4 Select contents.

How to select the contents varies depending on items.

Selection from a list Example: Aspect

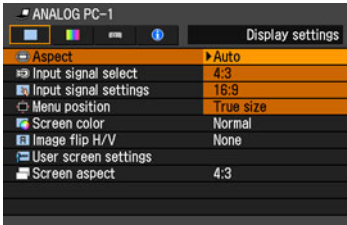

1. Press the **OK** button or [**>**], and a list of the contents is displayed.
2. Use [**^**] / [**v**] to select contents.
3. If you found the contents you desired, press the **OK** button or [**>**].

With [**<**] / [**>**] Example: Contrast

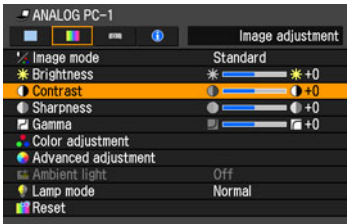

Use [**<**] / [**>**] to change the adjustment volume.

In a different screen (1) Example: Menu position

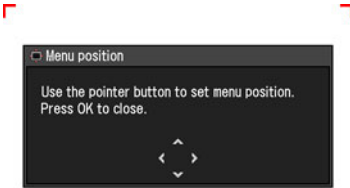

1. Press the **OK** button to display a different screen.
2. The follow the instruction on the screen.

In a different screen (2) Example: Tracking



1. Press the **OK** button to display a different screen.
2. Use [**^**] / [**v**] to select contents, and use [**<**] / [**>**] to select a value.
3. If you found the contents you desired, press the **OK** button.

5 Press the MENU button, and the menu screen disappears.

Setting Display Status

Selecting an Image Projection Mode

[Aspect]

- | | |
|----------------------------------|-------------------------------------|
| <input type="radio"/> HDMI | <input type="radio"/> COMPONENT |
| <input type="radio"/> DIGITAL PC | <input type="radio"/> VIDEO/S-VIDEO |
| <input type="radio"/> ANALOG PC | <input type="radio"/> USB |



You can select a projection mode corresponding to the aspect ratio of image.

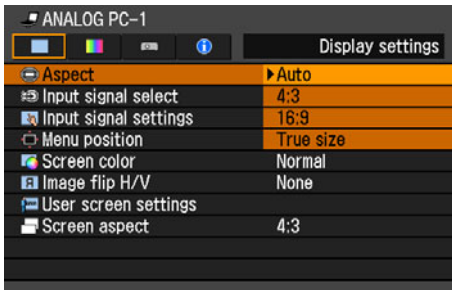

- Different contents are displayed for different screen aspects or input signal types.
- The **ASPECT** button on the remote control can also be used to select the Aspect settings.

Auto An image is projected at an aspect ratio of the input signal. Select this mode for normal image projection.

4:3 An image is projected at an aspect ratio of 4:3. Select this if an image of 4:3 aspect ratio cannot be appropriately projected in the [AUTO] mode.

16:9 An image is projected at an aspect ratio of 16:9. Select this if an image of 16:9 aspect ratio cannot be appropriately projected in the [AUTO] mode.

Zoom An image with 4:3 aspect ratio is projected in the center of the screen enlarged in 16:9 aspect ratio with the upper and lower portion of the image cut off. Select this when projecting visual software having aspect ratio of 4:3 and black belts at the top and bottom of the image.

- This mode is available when you select [16:9] or [16:9 D. image shift] for [Screen aspect] and select [HDMI (576p, 480p) (SX80 II)], [COMPONENT (576p, 480p, 576i, 480i)], [VIDEO] or [S-VIDEO (SX80 II)] for input signal.

True size An image is projected with the original resolution of the input signal. Select this to clearly project computer screen images having a resolution SXGA+ or lower (VGA, SVGA, XGA or SXGA) or visual software having a resolution lower than 1035i.

- This mode is available when you select [HDMI (720p, 576p, 480p) (SX80 II)] or [COMPONENT (720p, 576p, 480p)] for input signal.
- It is not available for an image having a resolution higher than SXGA+ or visual software having a resolution of 1080i, 1080p, 1035i, 576i or 480i.
- It is also available if the input signal is [ANALOG PC-1], [ANALOG PC-2], or [DIGITAL PC (SX80 II)]; however, it may not be available depending on the screen aspect setting.

Press the **OK** button to accept your setting and then press the **MENU** button.

- ! [Auto] and [True size] are not available if the input signal type is [VIDEO].
- [Auto] is automatically selected if the input signal type is [USB]. (SX80 II)

Selecting an Input Signal Type (ANALOG PC)

[Input signal select]

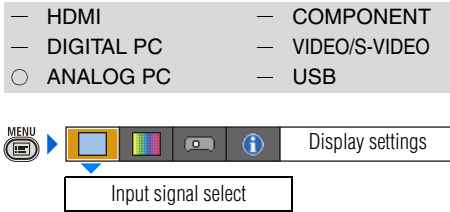

You can select a proper resolution if auto PC adjustment function (P57) cannot project a correct image from a computer.

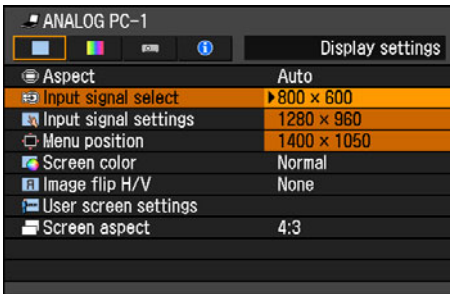

Press the **OK** button to accept your setting and then press the **MENU** button.

Select an input signal corresponding to the resolution of the computer.

- For the signal types supported by the projector, see the table on page 150.

Selecting an Input Signal Type (VIDEO/S-VIDEO*)

[Input signal select]

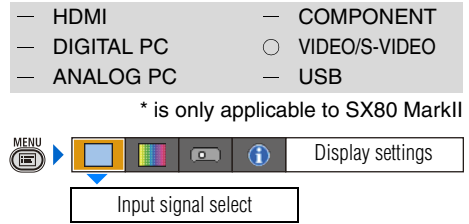

You can select a proper signal type if a video image from your AV equipment is not projected correctly.

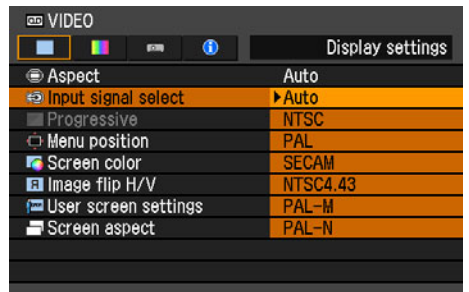

Press the **OK** button to accept your setting and then press the **MENU** button.

- [Auto] is the factory default.
- Refer to the User's Manual of your AV equipment connected to the projector to confirm the input signal type.

Selecting an Input Signal Type (COMPONENT)

[Input signal select]

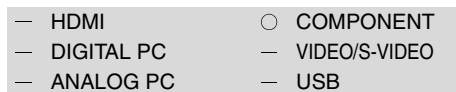

You can select a proper component signal type, if a video image from AV equipment is not projected correctly.

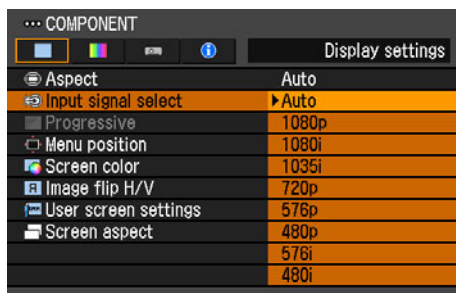

Press the **OK** button to accept your setting and then press the **MENU** button.

- [Auto] is the factory default.
- Refer to the User's Manual of your AV equipment connected to the projector to confirm the component signal type.

Adjusting Input Signal (ANALOG PC) – Total Dots

[Input signal settings] - [Total dots]

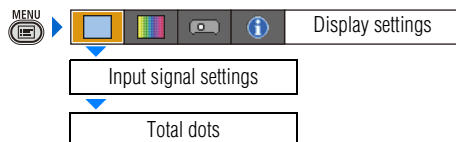

You can adjust the total number of dots in the horizontal direction. Adjust it when stripes are displayed on the screen.

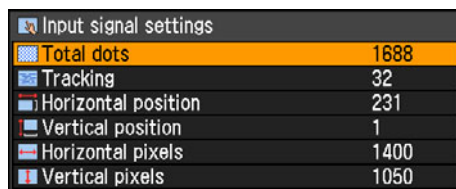

Use [**<**] / [**>**] to select a value. When you have completed the adjustment, press the **MENU** button.

- Perform this adjustment if the [AUTO PC] function (P57) cannot adjust the project image correctly.
- You can make adjustment either for [ANALOG PC-1] or [ANALOG PC-2].

Adjusting Input Signal (ANALOG PC) – Tracking

[Input signal settings] - [Tracking]

— HDMI	— COMPONENT
— DIGITAL PC	— VIDEO/S-VIDEO
<input type="radio"/> ANALOG PC	— USB

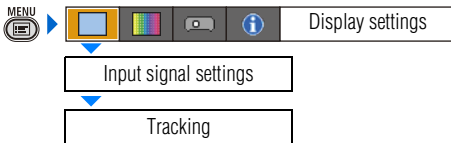

You can fine-tune the timing for generating an image from the image signal. Adjusts the tracking when the image distorts or flickers.

Input signal settings	
Total dots	1688
Tracking	32
Horizontal position	231
Vertical position	1
Horizontal pixels	1400
Vertical pixels	1050

Use [$<$] / [$>$] to select a value. When you have completed the adjustment, press the **MENU** button.

- Perform this adjustment if the [AUTO PC] function (P57) cannot adjust the project image correctly.
- You can make adjustment either for [ANALOG PC-1] or [ANALOG PC-2].

Adjust Input Signal (ANALOG PC) – Horizontal position

[Input signal settings] - [Horizontal position]

— HDMI	— COMPONENT
— DIGITAL PC	— VIDEO/S-VIDEO
<input type="radio"/> ANALOG PC	— USB

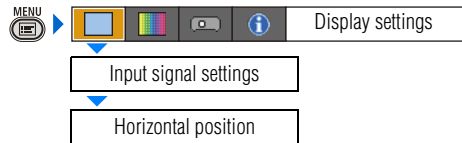

You can adjust the horizontal position of the screen when the projected image is shifted in the horizontal direction.

Input signal settings	
Total dots	1688
Tracking	32
Horizontal position	231
Vertical position	1
Horizontal pixels	1400
Vertical pixels	1050

Use [$<$] / [$>$] to select a value. As the value increases, the screen moves to the left.

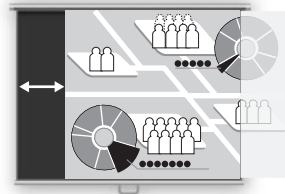

When you have completed the adjustment, press the **MENU** button.

- Perform this adjustment if the [AUTO PC] function (P57) cannot adjust the project image correctly.
- You can make adjustment either for [ANALOG PC-1] or [ANALOG PC-2].

Adjust Input Signal (ANALOG PC) – Vertical position

[Input signal settings] - [Vertical position]

— HDMI	— COMPONENT
— DIGITAL PC	— VIDEO/S-VIDEO
<input type="radio"/> ANALOG PC	— USB

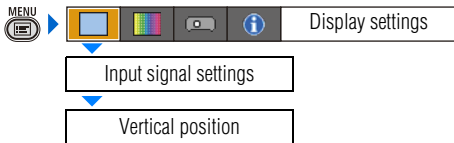

You can adjust the vertical position of the screen when the projected image is shifted in the vertical direction.

Input signal settings	
Total dots	1688
Tracking	32
Horizontal position	231
Vertical position	1
Horizontal pixels	1400
Vertical pixels	1050

Use [$<$] / [$>$] to select a value. As the value increases, the screen moves upward.

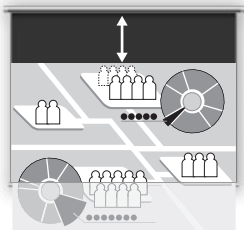

When you have completed the adjustment, press the **MENU** button.

- Perform this adjustment if the [AUTO PC] function (P57) cannot adjust the project image correctly.
- You can make adjustment either for [ANALOG PC-1] or [ANALOG PC-2].

Adjust Input Signal (ANALOG PC) – Horizontal pixels

[Input signal settings] - [Horizontal pixels]

— HDMI	— COMPONENT
— DIGITAL PC	— VIDEO/S-VIDEO
<input type="radio"/> ANALOG PC	— USB

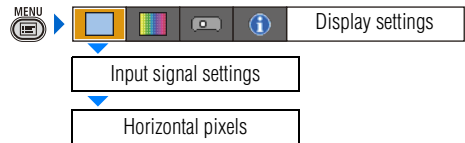

You can adjust the number of the pixels in the horizontal direction if the length of the screen is too long or too short in the horizontal direction.

Input signal settings	
Total dots	1688
Tracking	32
Horizontal position	231
Vertical position	1
Horizontal pixels	1400
Vertical pixels	1050

Use [$<$] / [$>$] to select a value.

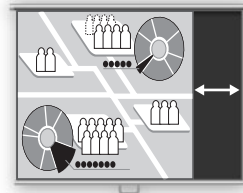

When you have completed the adjustment, press the **MENU** button.

- Perform this adjustment if the [AUTO PC] function (P57) cannot adjust the project image correctly.
- You can make adjustment either for [ANALOG PC-1] or [ANALOG PC-2].

Adjust Input Signal (ANALOG PC) – Vertical pixels

[Input signal settings] - [Vertical pixels]

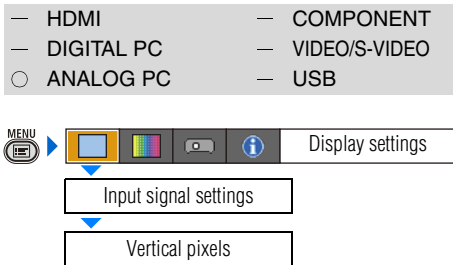

You can adjust the number of the pixels in the vertical direction if the length of the screen is too long or too short in the vertical direction.

Input signal settings	
Total dots	1688
Tracking	32
Horizontal position	231
Vertical position	1
Horizontal pixels	1400
Vertical pixels	1050

Use [**<**] / [**>**] to select a value.

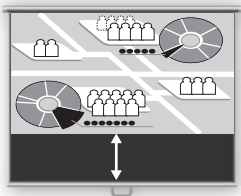

When you have completed the adjustment, press the **MENU** button.

- Perform this adjustment if the [AUTO PC] function (P57) cannot adjust the project image correctly.
- You can make adjustment either for [ANALOG PC-1] or [ANALOG PC-2].

Selecting HDMI Input Level (SX80 II)

[HDMI input level]



You can select this as required when you project visual software with the HDMI signals.

HDMI	
Display settings	
Aspect	Auto
HDMI input level	Auto
HDMI over scan	Normal
Progressive	Expanded
Menu position	
Screen color	Normal
Image flip H/V	None
User screen settings	
Screen aspect	4:3

Press the **OK** button to accept your setting and then press the **MENU** button.

- [Auto] is the factory default.
- You can select this only when the type of signal sent from AV equipment is RGB.
- The signal level is select automatically in [Auto] mode. (Some AV equipment may not support this.)
- If the HDMI output of your AV equipment allows switching between [Normal] and [Expanded], we recommend you to set [Expanded]. The contrast of images will be improved and dark scenes will be rendered more realistically. In this case, select [Auto] or [Expanded] for the HDMI input level.

For more detailed information, refer to the User's Manual of your AV equipment connected to the projector.

Select HDMI Over Scan (SX80 II)

[HDMI over scan]

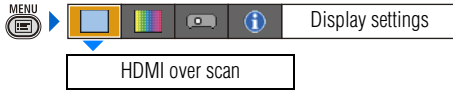

You can select this as required when you project visual software with the HDMI signals.

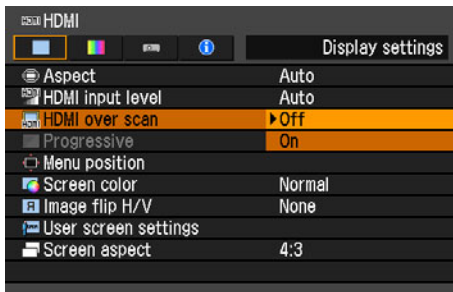

- Off** The entire input signals (100%) are projected.
The images projected may be smaller than the full projection screen.
- On** Images are projected with disorders at their peripheral section of images trimmed off. (The central 95% of the images are projected.)
A part of peripheral sections of images may be cut out depending on the resolution of the signals. In such a case, select [Off].

Press the **OK** button to accept your setting and then press the **MENU** button.

- [On] is the factory default.

Performing Progressive Processing

[Progressive]

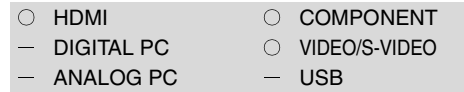

You can select this as required when the images have low resolution.

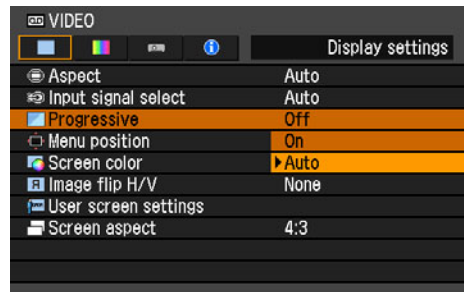

- Off** Do not perform the progressive processing.
- On** Performs the progressive processing. This mode is available when the HDMI signal is 1080i or, VIDEO/S-VIDEO or COMPONENT signal is 1080i, 1035i, 576i, or 480i.
- Auto** Performs the appropriate progressive processing according to the input signal.

Press the **OK** button to accept your setting and then press the **MENU** button.

- [Auto] is the factory default.
- You can set this mode for either [HDMI (SX80 II)], [COMPONENT], [VIDEO] or [S-VIDEO (SX80 II)].
- Select [Off] when flickers and horizontal lines are noticeable on a fast-moving picture.
- For the details of the progressive processing, refer to the page 154.

Selecting a Menu Position

[Menu position]

- | | |
|----------------------------------|-------------------------------------|
| <input type="radio"/> HDMI | <input type="radio"/> COMPONENT |
| <input type="radio"/> DIGITAL PC | <input type="radio"/> VIDEO/S-VIDEO |
| <input type="radio"/> ANALOG PC | <input type="radio"/> USB |



You can change the position of menu displayed.

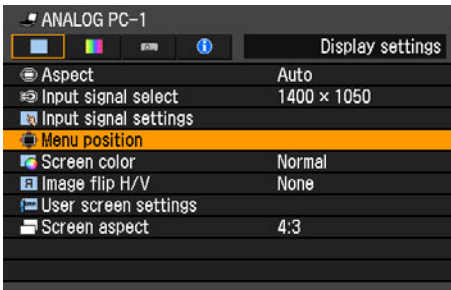

Move the menu to the desired position with [\wedge] / [\lt] / [\vee] / [\gt].



When the menu has been moved to the desired position, press the **OK** or **MENU** button.

Correcting the Screen Color

[Screen color]

- | | |
|----------------------------------|-------------------------------------|
| <input type="radio"/> HDMI | <input type="radio"/> COMPONENT |
| <input type="radio"/> DIGITAL PC | <input type="radio"/> VIDEO/S-VIDEO |
| <input type="radio"/> ANALOG PC | <input type="radio"/> USB |



You can adjust the color quality of the images projected corresponding to the color of the projection screen.

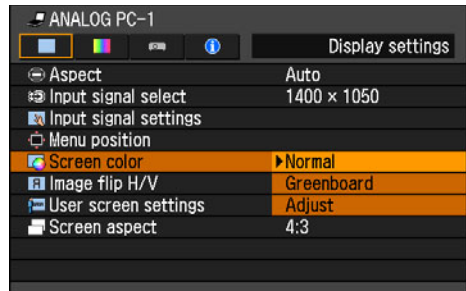

Normal Select this if a standard type of projection screen is used. The images are projected in the light quality similar to that of natural light.

Greenboard Select this if a greenboard (in dark green color) is used for the projection screen. The color quality similar to [Normal] is obtained on the greenboard.

Adjust Select this if you make detailed adjustment. The following popup screen will appear.

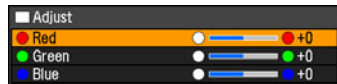

Use [\wedge] / [\vee] to select a primary color. [\gt] makes the color selected darker. [\lt] makes the color selected lighter. Press the **AUTO SET** button while the screen is displayed if you want to perform the auto color correction. (SX80 II)

Press the **OK** button to accept your setting and then press the **MENU** button.

- [Normal] is the factory default.

Reversing projection

[Image flip H/V]

- | | |
|----------------------------------|-------------------------------------|
| <input type="radio"/> HDMI | <input type="radio"/> COMPONENT |
| <input type="radio"/> DIGITAL PC | <input type="radio"/> VIDEO/S-VIDEO |
| <input type="radio"/> ANALOG PC | <input type="radio"/> USB |



You can make this setting if you want to hang the projector from the ceiling or project an image from behind the screen.

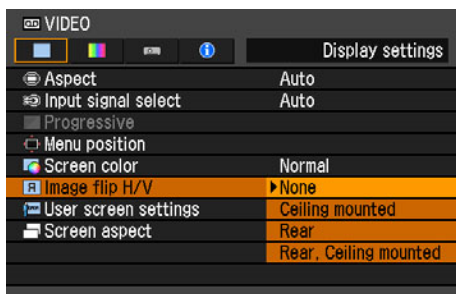

None	Select this if you project an image normally.
Ceiling mounted	Select this if you project an image with the projector hung from the ceiling. The projected images is inverted in both vertical and horizontal directions.
Rear	Select this if you project an image from behind the screen. The projected images is inverted in the horizontal direction.
Rear, Ceiling mounted	Select this if you project an image from behind the screen with the projector hung from the ceiling. The projected image is inverted in the vertical direction.

Press the **OK** button to accept your setting and then press the **MENU** button.

- [None] is the factory default.

None (Normal image)

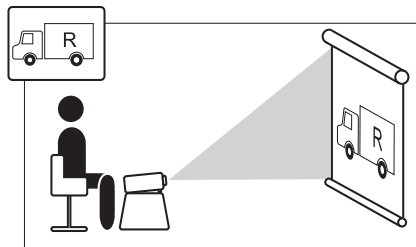

Ceiling mounted

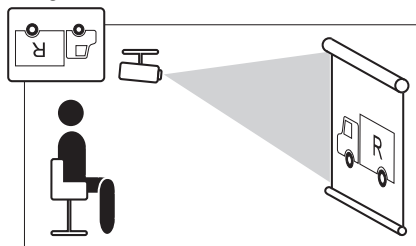

Rear

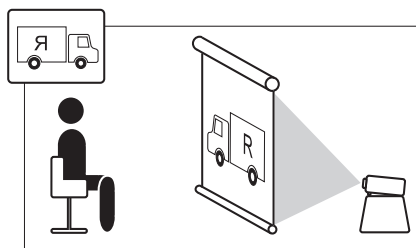

Rear, Ceiling mounted

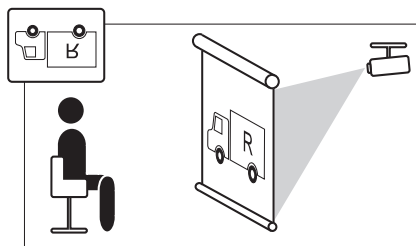

- To hang the projector from the ceiling, use the optional bracket. Contact your Canon dealer.
- The keystone distortion adjustment will be reset.

Capturing a Logo (SX800)

[User screen settings] - [Logo capture]

- ANALOG PC
- COMPONENT
- VIDEO

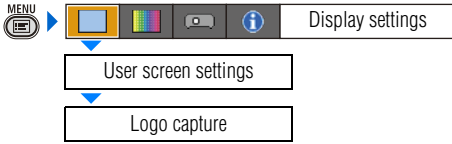

You can capture a part of the images being projected as [User logo].

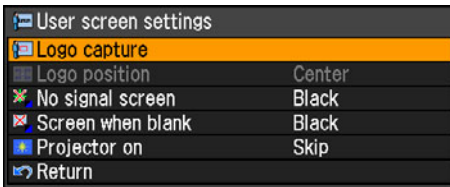

A screen for capturing images is displayed.

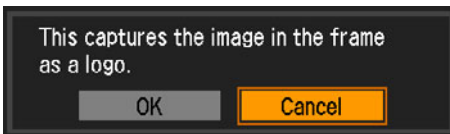

OK Press the **OK** button, and the image in the red frame is captured as [User logo].

Cancel Cancels the image capturing.

- For projecting the captured log on a screen, select [User logo] on the [Projector on], [No signal screen], [Screen when blank].
- You may not capture an image depending on the resolution and scan system.
- You cannot capture an image when [16:9] or [16:9 D. image shift] is selected for [Screen aspect].

Selecting the User Logo Display Position (SX800)

[User screen settings] - [Logo position]

- ANALOG PC
- COMPONENT
- VIDEO

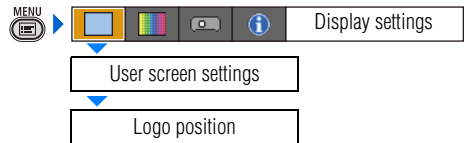

You can select a log display position.

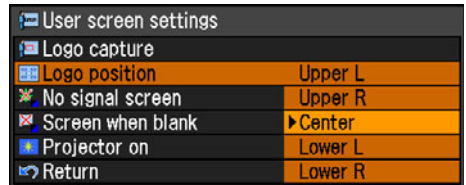

Upper L Select a position you want to display a user logo and press the

Upper R display a user logo and press the

Center OK button.

Lower L

Lower R

Press the **OK** button to accept your setting and then press the **MENU** button.

- [Center] is the factory default.
- You cannot select [Logo position] if you have not captured a user logo on the [Logo capture] screen.

No Signal Screen (SX80 II)

[User screen settings] - [No signal screen]

- HDMI COMPONENT
 DIGITAL PC VIDEO/S-VIDEO
 ANALOG PC USB

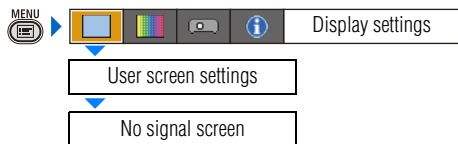

You can display either of a black or blue screen when there is no input signal.



Black	The screen is all black.
Blue	The screen is blue background.

Press the **OK** button to accept your setting and then press the **MENU** button.

- [Blue] is the factory default.

Screen When Blank (SX80 II)

[User screen settings] - [Screen when blank]

- HDMI COMPONENT
 DIGITAL PC VIDEO/S-VIDEO
 ANALOG PC USB

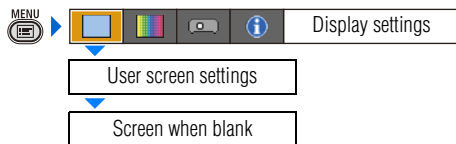

You can display a black or blue screen when the projected image is blanked off temporarily by pressing the **BLANK** button on the remote control.



Black	The screen is all black.
Blue	The screen is blue background.

Press the **OK** button to accept your setting and then press the **MENU** button.

- [Black] is the factory default.

Selecting a Logo at Startup (SX80 II)

[User screen settings] - [Projector on]

- HDMI
- DIGITAL PC
- ANALOG PC
- COMPONENT
- VIDEO/S-VIDEO
- USB

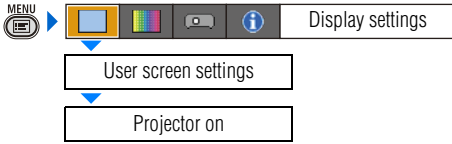

You can display a specified logo on a screen from the moment the projector is turned on to the moment it is ready for projection.

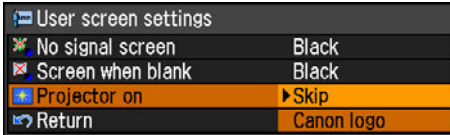

Skip	Projects an input signal immediately after turning on the projector.
Canon logo	Displays the Canon logo captured at the factory.

Press the **OK** button to accept your setting and then press the **MENU** button.

- [Canon logo] is the factory default.

No Signal Screen (SX800)

[User screen settings] - [No signal screen]

- ANALOG PC
- COMPONENT
- VIDEO

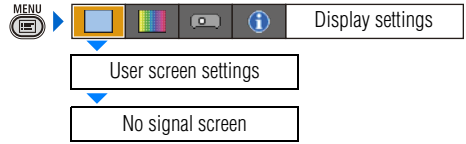

You can display a user logo on a screen when there is no input signal.

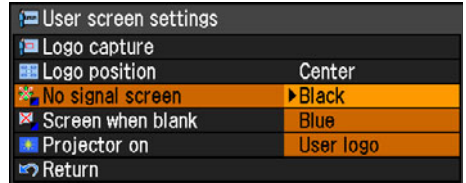

Black	The screen is all black. Displays no user logo.
Blue	The screen is blue background. Displays no user logo.
User logo	Displays a user logo.

Press the **OK** button to accept your setting and then press the **MENU** button.

- [Blue] is the factory default.
- [User logo] is available only when a user's logo has been registered.

Screen When Blank (SX800)

[User screen settings] - [Screen when blank]

- ANALOG PC
- COMPONENT
- VIDEO

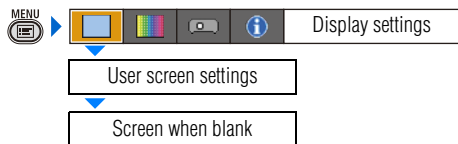

You can display a user logo a screen when the projected image is blackened out temporarily by pressing the **BLANK** button on the remote control.

User screen settings	
Logo capture	
Logo position	Center
No signal screen	Black
Screen when blank	Black
Projector on	Blue
Return	User logo

Black	The screen is all black. Displays no user logo.
Blue	The screen is blue background. Displays no user logo.
User logo	Displays a user logo.

Press the **OK** button to accept your setting and then press the **MENU** button.

- [Black] is the factory default.
- [User logo] is available only when a user's logo has been registered.

Selecting a Logo at Startup (SX800)

[User screen settings] - [Projector on]

- ANALOG PC
- COMPONENT
- VIDEO

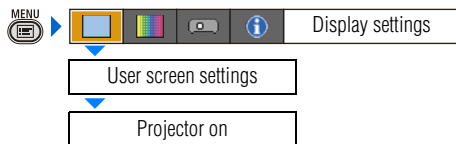

You can display a specified logo on a screen from the moment the projector is turned on to the moment it is ready for projection.

User screen settings	
Logo capture	
Logo position	Center
No signal screen	Black
Screen when blank	Skip
Projector on	Canon logo
Return	User logo

Skip	Projects an input signal immediately after turning on the projector.
Canon logo	Displays the Canon logo captured at the factory.
User logo	Displays a user logo captured on the [Logo capture] screen.

Press the **OK** button to accept your setting and then press the **MENU** button.

- [Canon logo] is the factory default.
- [User logo] is available only when a user's logo has been registered.

Selecting Aspect Ratio of Screen

[Screen aspect]

- | | |
|----------------------------------|-------------------------------------|
| <input type="radio"/> HDMI | <input type="radio"/> COMPONENT |
| <input type="radio"/> DIGITAL PC | <input type="radio"/> VIDEO/S-VIDEO |
| <input type="radio"/> ANALOG PC | <input type="radio"/> USB |



You can select proper option corresponding to the aspect ratio of the projecting screen.

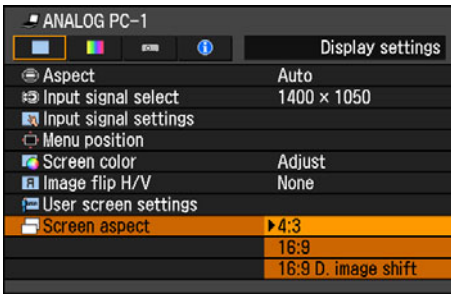

- | | |
|---------------------------|---|
| 4:3 | Select this when you use a screen with aspect ratio of 4:3.
You can adjust the keystone distortion with D.SHIFT/KEYSTONE button. |
| 16:9 | Select this when you use a screen with aspect ratio of 16:9.
You can adjust the keystone distortion with D.SHIFT/KEYSTONE button. |
| 16:9
D. image
shift | Select this when you use a screen with aspect ratio of 16:9.
You can move the screen upward or downward with D.SHIFT/KEYSTONE button. |

Press the **OK** button to accept your setting and then press the **MENU** button.

- [4:3] is the factory default.
- If you select [16:9 D. image shift], the keystone adjustment will be reset. For more details, refer to the page [63](#).
- [Auto] may be automatically selected for [Screen aspect] depending on the screen aspect setting.

Setting the Image Quality

Selecting an Image Quality

[Image mode]

- | | |
|----------------------------------|-------------------------------------|
| <input type="radio"/> HDMI | <input type="radio"/> COMPONENT |
| <input type="radio"/> DIGITAL PC | <input type="radio"/> VIDEO/S-VIDEO |
| <input type="radio"/> ANALOG PC | <input type="radio"/> USB |

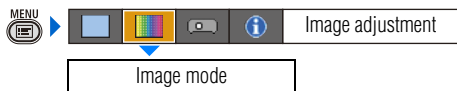

You can select an image mode suitable for the projecting image.

You can select it also with the **IMAGE** button on the remote control.

SX80 MarkII

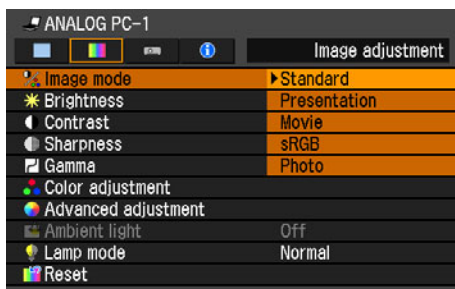

Press the **OK** button to accept your setting and then press the **MENU** button.

- [Standard] is the factory default.
- You can decide the image quality by adjusting the following items in each image mode: [Brightness], [Contrast], [Sharpness], [Gamma], [Color adjustment] and [Lamp mode].
- The adjustment you have made is stored as each combination of input signals and an image mode.

Standard	Select this to project an image with near-original quality and a high regard for reproduction of white. It is suited to showing a computer screen or watching visual software (moving pictures) in a bright room.
Presentation	Select this to project an image with quality suited for the presentation. It is also suited to project visual software (moving pictures) with a high regard for the brightness.
Movie	Select this to project moving pictures of all kinds. Its brightness is suited to easily enjoy the atmosphere of a movie theatre in a dim room.
sRGB	Select this if you want to project an image in the display mode conforming to the sRGB standard (P152). It is suited to project an image shot by sRGB-compatible digital camera.
Photo *	If you select [Photo] for [Image mode], make sure to set [Ambient light] in the [Image adjustment] as well. You can correct an image according to the ambient light based on [sRGB] in [Image mode] and project the image with higher tone on the screen by setting [Ambient light]. It is suited to project an ornamental photo, etc. under an ambient light. It is available if the input signal is [ANALOG PC-1], [ANALOG PC-2], [DIGITAL PC], or [USB].

* is only applicable to SX80 MarkII

Adjusting the Brightness

[Brightness]

- HDMI
- DIGITAL PC
- ANALOG PC
- COMPONENT
- VIDEO/S-VIDEO
- USB



You can adjust the brightness of images.

SX80 MarkII

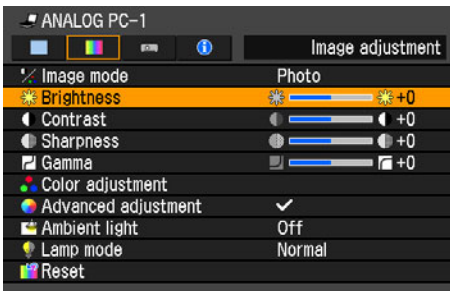

[>] Increases the brightness of an image.

[<] Decreases the brightness of an image.

When you have completed the adjustment, press the **MENU** button.

- The adjustment you have made is stored as an adjusted value of input signals being projected in an image mode.

Adjusting the Contrast

[Contrast]

- HDMI
- DIGITAL PC
- ANALOG PC
- COMPONENT
- VIDEO/S-VIDEO
- USB



You can adjust the contrast of images.

If you want to make it more or less vivid, adjust the difference in tone between the lightest and darkest portions of the image.

SX80 MarkII

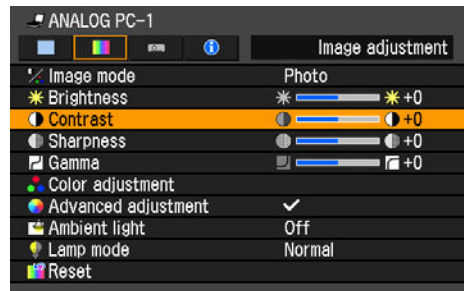

[>] Increases the contrast of an image. It emphasizes the darker portion and the bright portion on the projected image.

[<] Decreases the contrast of an image. The image becomes less vivid.

When you have completed the adjustment, press the **MENU** button.

- The adjustment you have made is stored as an adjusted value of input signals being projected in an image mode.

Adjusting the Sharpness

[Sharpness]

- HDMI
- DIGITAL PC
- ANALOG PC
- COMPONENT
- VIDEO/S-VIDEO
- USB



You can adjust the sharpness of images.
SX80 MarkII

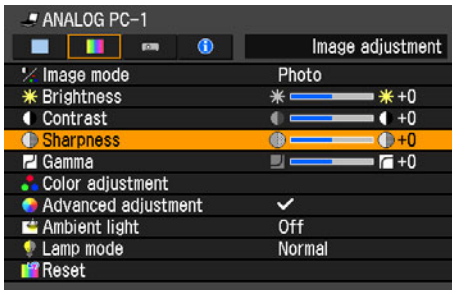

[>] Increases the sharpness of an image.

[<] Decreases the sharpness of an image.

When you have completed the adjustment, press the **MENU** button.

- The adjustment you have made is stored as an adjusted value of input signals being projected in an image mode.

Making a Gamma Correction

[Gamma]

- HDMI
- DIGITAL PC
- ANALOG PC
- COMPONENT
- VIDEO/S-VIDEO
- USB

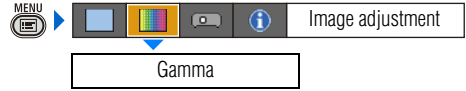

You can correct the obscure portion of an image due to too dark or bright.

SX80 MarkII

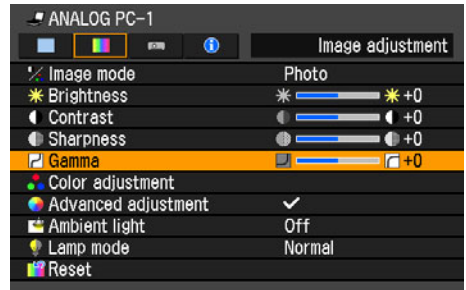

[>] Brighten the dark portion.

[<] Darken the bright portion.

When you have completed the adjustment, press the **MENU** button.

- The adjustment you have made is stored as an adjusted value of input signals being projected in an image mode.
- For the details of the gamma correction, refer to the page [154](#).

Making Color Adjustment (HDMI) (SX80 II)

[Color adjustment]

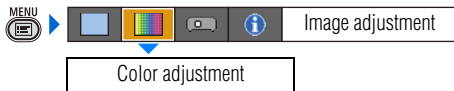
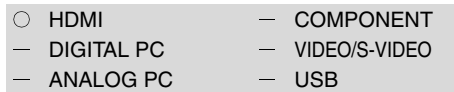

You can adjust the color quality of images for each of primary colors, red, green and blue.



R/G/B Gain Adjust the intensity of each color.
 [>] Increases the color intensity.
 [<] Decreases the color intensity.

R/G/B Offset Adjusts the color reproducibility of dark portions of each color.
 [>] Increases the color reproducibility of color.
 [<] Decreases the color reproducibility of color.

When you have completed the adjustment, press the **MENU** button.

- The adjustment you have made is stored as an adjusted value of input signals being projected in an image mode.
- Adjusting a color makes mark shown in [Color adjustment] in the menu.

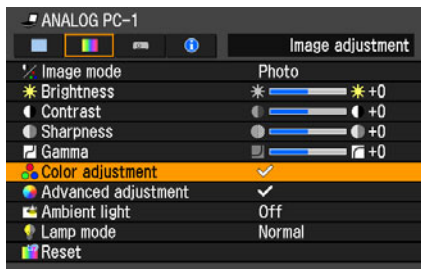

Making Color Adjustment (Digital PC/ Analog PC/USB) (SX80 II)

[Color adjustment]



You can adjust the color of an image for each of primary colors, red, green, and blue. You can also adjust the color temperature.

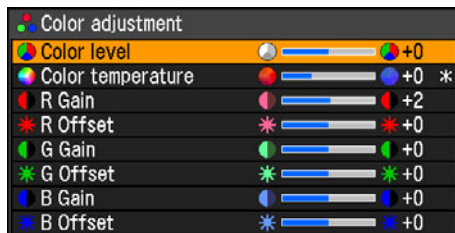

Color level* Adjusts the intensity of each color.
 [>] Increases the intensity of color.
 [<] Decreases the intensity of color.

Color temperature* Adjusts the color temperature of the image.
 [>] Changes to the blue color (cold color).
 [<] Changes to the red color (warm color).

R/G/B Gain The same as “Making Color Adjustment (HDMI)”.

R/G/B Offset The same as “Making Color Adjustment (HDMI)”.

* You can set this if you have selected [Photo] for [Image mode].

When you have completed the adjustment, press the **MENU** button.

- The adjustment you have made is stored as an adjusted value of input signals being projected in an image mode.
- If you change R/G/B Gain or Offset once color temperature has been specified, the "*" mark is displayed at the right side of the setting value to indicate the color temperature has been specified.

Making Color Adjustment (COMPONENT/VIDEO/S-VIDEO) (SX80 II)

[Color adjustment]

- HDMI ○ COMPONENT
- DIGITAL PC ○ VIDEO/S-VIDEO
- ANALOG PC — USB



You can adjust the color depth and hue of images for each of primary colors, red, green and blue.



Color level Adjusts the intensity of each color.
 [>] Increases the intensity of color.
 [<] Decreases the intensity of color.

Color balance Adjusts the color balance of a reddish or greenish image.
 [>] Corrects a reddish image.
 [<] Corrects a greenish image.

R/G/B Gain The same as “Making Color Adjustment (HDMI)”.

R/G/B Offset The same as “Making Color Adjustment (HDMI)”.

When you have completed the adjustment, press the **MENU** button.

- You cannot adjust the [Color balance] in [Video] or [S-Video] except NTSC.
- The adjustment you have made is stored as an adjusted value of input signals being projected in an image mode.

Making Color Adjustment (Analog PC) (SX800)

[Color adjustment]

- ANALOG PC
- COMPONENT
- VIDEO



You can adjust the color quality of images for each of primary colors, red, green and blue.



R/G/B Gain Adjust the intensity of each color.
 [>] Increases the color intensity.
 [<] Decreases the color intensity.

R/G/B Offset Adjusts the color reproducibility of dark portions of each color.
 [>] Increases the color reproducibility of color.
 [<] Decreases the color reproducibility of color.

When you have completed the adjustment, press the **MENU** button.

- The adjustment you have made is stored as an adjusted value of input signals being projected in an image mode.
- Adjusting a color makes mark shown in [Color adjustment] in the menu.



Making Color Adjustment (COMPONENT/VIDEO) (SX800)

[Color adjustment]



You can adjust the color depth and hue of images for each of primary colors, red, green and blue.

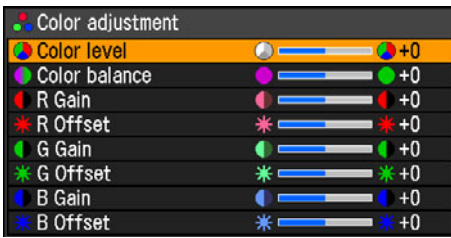

Color level	Adjusts the intensity of each color. [>] Increases the intensity of color. [<] Decreases the intensity of color.
Color balance	Adjusts the color balance of a reddish or greenish image. [>] Corrects a reddish image. [<] Corrects a greenish image.
R/G/B Gain	The same as "Making Color Adjustment (Analog PC) (SX800)".
R/G/B Offset	The same as "Making Color Adjustment (Analog PC) (SX800)".

When you have completed the adjustment, press the **MENU** button.

- You cannot adjust the [Color balance] in [Video] except NTSC.
- The adjustment you have made is stored as an adjusted value of input signals being projected in an image mode.

Making Advanced Adjustment (Noise reduction)

[Advanced adjustment] - [Noise reduction]

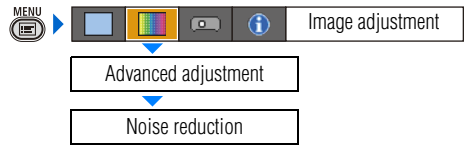
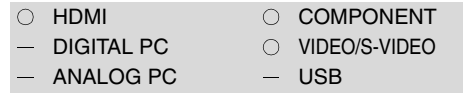

You can reduce noise of picture.

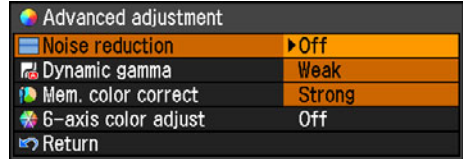

Off	Disables noise reduction.
Weak	Select this option for noisy picture.
Strong	Select this option for excessively noisy picture.

Press the **OK** button to accept your setting and then press the **MENU** button.

- [Off] is the factory default.
- Noise reduction may produce an after-image for quick footage.
- Select [Weak] for quick footage. Select [Strong] for slow footage.
- The setting you have made is stored as a setting value of input signals being projected in an image mode.
- Making this setting makes mark shown in [Advanced adjustment] in the menu.

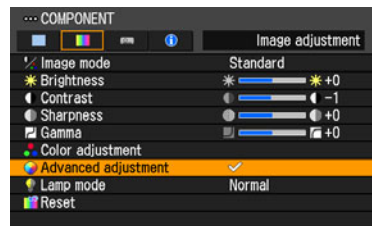

Making Advanced Adjustment (Dynamic gamma)

[Advanced adjustment] - [Dynamic gamma]

- | | |
|----------------------------------|-------------------------------------|
| <input type="radio"/> HDMI | <input type="radio"/> COMPONENT |
| <input type="radio"/> DIGITAL PC | <input type="radio"/> VIDEO/S-VIDEO |
| <input type="radio"/> ANALOG PC | <input type="radio"/> USB |

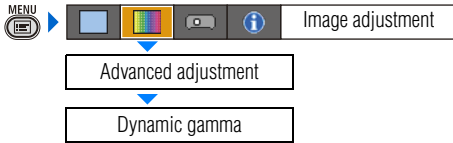

You can adjust the gradation representation of light and dark portions of an image automatically.

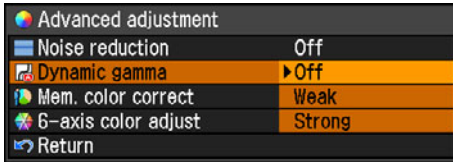

- Off** Dynamic gamma is disabled.

- Weak** Dynamic gamma is used a little.

- Strong** Dynamic gamma is used to a large extent.

Press the **OK** button to accept your setting and then press the **MENU** button.

- [Off] is the factory default.
- The adjustment you have made is stored as an adjusted value of input signals being projected in an image mode.

Making Advanced Adjustment (Mem. color correct) (SX80 II)

[Advanced adjustment] - [Mem. color correct]

- | | |
|----------------------------------|-------------------------------------|
| <input type="radio"/> HDMI | <input type="radio"/> COMPONENT |
| <input type="radio"/> DIGITAL PC | <input type="radio"/> VIDEO/S-VIDEO |
| <input type="radio"/> ANALOG PC | <input type="radio"/> USB |

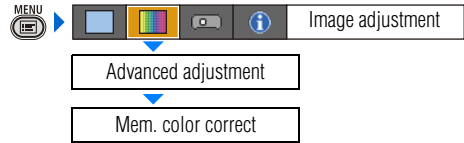

You can correct colors (e.g. blue sky, field of grass, skin) in our memory so that they can be projected more vividly.

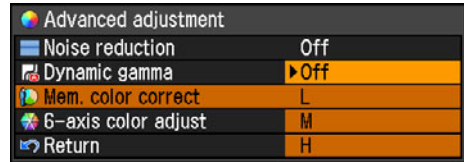

- Off** Disables the memorized color correction function.

- L** Specifies the intensity of the memorized color correction in three steps.
- M**
- H**

Press the **OK** button to accept your setting and then press the **MENU** button.

- [Off] is the factory default.
- The adjustment you have made is stored as an adjusted value of input signals being projected in an image mode.
- For the details of the memorized color correction, refer to the page [155](#).

Making Advanced Adjustment (Auto fleshtone) (SX800)

[Advanced adjustment] - [Auto fleshtone]

- ANALOG PC
- COMPONENT
- VIDEO

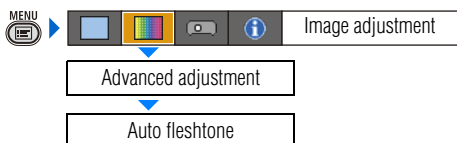

You can represent the skin color impressively.

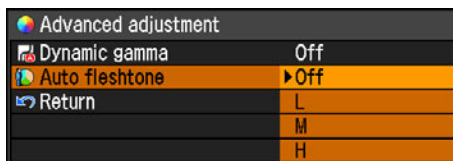

Off	Disables the [Auto fleshtone] function.
L	Specifies the intensity of the [Auto fleshtone] in three steps.
M	
H	

Press the **OK** button to accept your setting and then press the **MENU** button.

- The adjustment you have made is stored as an adjusted value of input signals being projected in an image mode.

Adjusting Fine Color Adjustment (6-axis color adjust) (SX80 II)

[Advanced adjustment] - [6-axis color adjust]

- HDMI
- DIGITAL PC
- ANALOG PC
- COMPONENT
- VIDEO/S-VIDEO
- USB

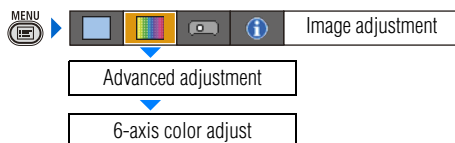

You can make fine color adjustment with RGB (red, green, blue) and CMY (cyan, magenta, yellow). For the details of 6-axis color adjust, refer to the page 155.

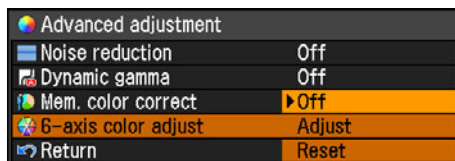

Off Disables the 6-axis color adjustment. If you select [Adjust], the previous setting of 6-axis color adjustment becomes active again.

Adjust Enables the 6-axis color adjustment.

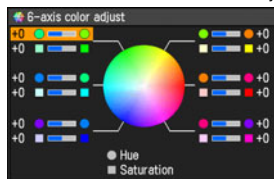

Use [\wedge] / [\vee] to select [\bigcirc Hue] or [\square Saturation], then adjust them with [$<$] / [$>$].

Reset Returns any adjustment values to zero.

When you have completed the adjustment, press the **MENU** button.

- [Off] is the factory default.
- The adjustment you have made is stored as an adjusted value of input signals being projected in an image mode.

Correcting the Image According to the Ambient Light (SX80 II)

[Ambient light]

- HDMI
- DIGITAL PC
- ANALOG PC
- COMPONENT
- VIDEO/S-VIDEO
- USB

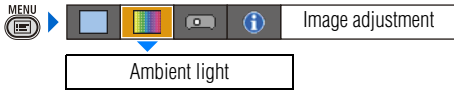

You can correct and project an image more appropriately according to the ambient light on the screen if you have selected [Photo] for [Image mode].

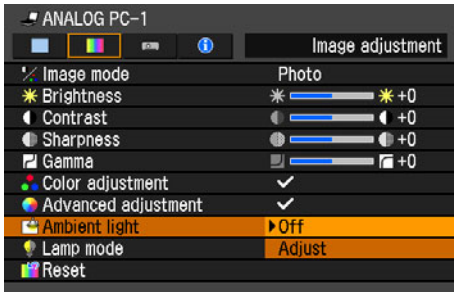

- Off** Projects an image with no correction.
- Adjust** You can specify the type and level (brightness) of the ambient light.



- Type Tungsten**
Select this if the ambient light source is a light bulb or bulb color fluorescent.
- Fluorescent**
Select this if the ambient light source is a day white fluorescent.
- Fluorescent H**
Select this if the ambient light source is a daylight fluorescent.

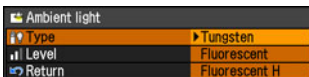

- Level L** Select this if the ambient light source is a light bulb or bulb color fluorescent.
- M** Select this if the ambient light source is a day white fluorescent.
- H** Select this if the ambient light source is a daylight fluorescent.

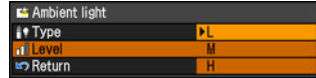

An Example of the Ambient Light Setting

Level	Example Location
L	A projection room, bar
M	Photo studio, galley
H	Conference room, lecture room

Press the **OK** button to accept your setting and then press the **MENU** button.

- [Off] is the factory default.
- You can set this if you have selected [Photo] for [Image mode].

Reducing the Lamp Brightness

[Lamp mode]

- | | |
|----------------------------------|-------------------------------------|
| <input type="radio"/> HDMI | <input type="radio"/> COMPONENT |
| <input type="radio"/> DIGITAL PC | <input type="radio"/> VIDEO/S-VIDEO |
| <input type="radio"/> ANALOG PC | <input type="radio"/> USB |



Reducing the lamp brightness reduces power consumption and cooling fan noise. You can enable or disable this mode also with the **LAMP** button on the remote control.

SX80 MarkII

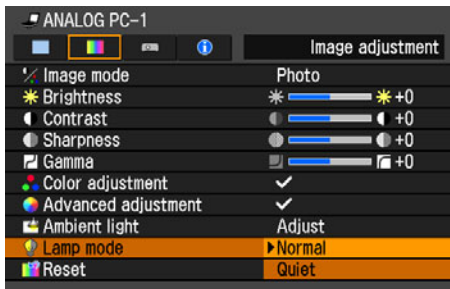

Normal Projects an image at the normal brightness level.

Quiet Reduces the lamp brightness and cooling fan noise.

Press the **OK** button to accept your setting and then press the **MENU** button.

- [Normal] is the factory default.
- The setting you have made is stored as a setting value of input signals being projected in an image mode.

Resetting the Image Settings

[Reset]

- | | |
|----------------------------------|-------------------------------------|
| <input type="radio"/> HDMI | <input type="radio"/> COMPONENT |
| <input type="radio"/> DIGITAL PC | <input type="radio"/> VIDEO/S-VIDEO |
| <input type="radio"/> ANALOG PC | <input type="radio"/> USB |



You can reset the current image settings to the default settings.

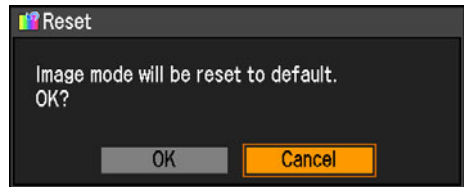

OK Resets the image settings.

Cancel Cancels resetting of the image settings.

Press the **OK** button to accept your setting and then press the **MENU** button.

- Only the setting of the combined input signals being projected and an image mode is reset.

Setting Various Function

Setting Auto Setup Function

[Auto setup]

- | | |
|----------------------------------|-------------------------------------|
| <input type="radio"/> HDMI | <input type="radio"/> COMPONENT |
| <input type="radio"/> DIGITAL PC | <input type="radio"/> VIDEO/S-VIDEO |
| <input type="radio"/> ANALOG PC | <input type="radio"/> USB |



You can select an items you want to enable in the auto setup function.

SX80 MarkII



Select [On] for the items if you want to enable in auto setup function.

Auto focus*	Enables the auto focusing.
Auto keystone	Enables the auto keystone correction.
Auto input	Enables the auto input selection.
Auto screen color*	Adjusts color quality of images corresponding to the color of the projection screen.

Press the **OK** button to accept your setting and then press the **MENU** button.

- The factory default settings are as follows:
 [Auto focus*]: [On]
 [Auto keystone]: [On]
 [Auto input]: [On]
 [Auto screen color*]: [Off]
- You cannot change any items in [Auto setup] if [16:9 D. Image shift] is selected for [Screen aspect]. In addition, you cannot perform the auto setup function. For the details of the [Auto setup], refer to the page 52.

* is only applicable to SX80 MarkII

Selecting the Power Management Mode

[Power management mode]

- | | |
|----------------------------------|-------------------------------------|
| <input type="radio"/> HDMI | <input type="radio"/> COMPONENT |
| <input type="radio"/> DIGITAL PC | <input type="radio"/> VIDEO/S-VIDEO |
| <input type="radio"/> ANALOG PC | <input type="radio"/> USB |

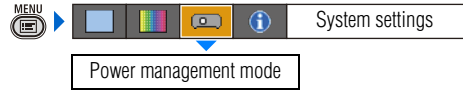

You can turn off the lamp or projector automatically for saving power.

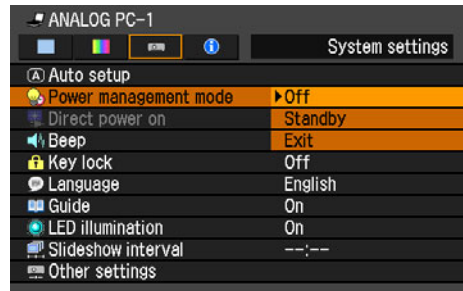

Off	Disables the power management mode.
Standby	If no input signal is received for 30 seconds, the projector enters the standby mode, turning off the lamp five minutes after start of countdown. If it receives the input signal or is operated during such period of 30 seconds, it resumes projection.
Exit	If no input signal is received for 30 seconds, it displays the count down and turns off the projector after 5 minutes.

Press the **OK** button to accept your setting and then press the **MENU** button.

- [Off] is the factory default.
- The **POWER** indicator flashes red and green when the projector is in the [Standby] power management mode.
- You cannot enable the [Direct power on] function (see the next item), if you select [Off].

Skip the POWER Button Operation

[Direct power on]

- | | |
|----------------------------------|-------------------------------------|
| <input type="radio"/> HDMI | <input type="radio"/> COMPONENT |
| <input type="radio"/> DIGITAL PC | <input type="radio"/> VIDEO/S-VIDEO |
| <input type="radio"/> ANALOG PC | <input type="radio"/> USB |



You can turn on the projector only by connecting the power cable without pressing the **POWER** button.

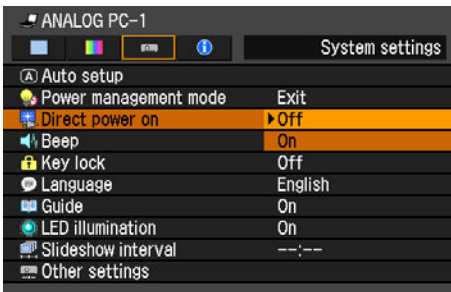

Off You need to press the **POWER** button to turn on the projector.

On You can turn on the projector only by connecting the power cable.

Press the **OK** button to accept your setting and then press the **MENU** button.

- [Off] is the factory default.



- Before setting the direct power-on to [On], be sure to set the [Power management mode], described on the preceding page, to [Standby] or [Exit].
- Wait at least 5 minutes when you power on the projector again after disconnecting it. It may shorten the lamp life if you turn on the projector immediately after turning it off.

Enabling/Disabling the Beep

[Beep]

- | | |
|----------------------------------|-------------------------------------|
| <input type="radio"/> HDMI | <input type="radio"/> COMPONENT |
| <input type="radio"/> DIGITAL PC | <input type="radio"/> VIDEO/S-VIDEO |
| <input type="radio"/> ANALOG PC | <input type="radio"/> USB |



You can select whether a beep sounds or not when you operate the projector.

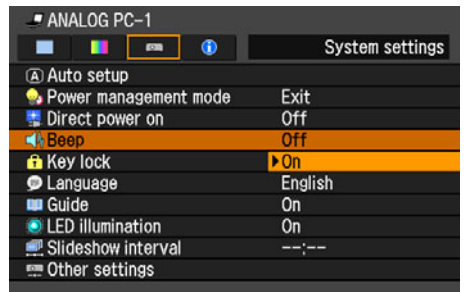

Off Disables the beep.

On Enables the beep.

Press the **OK** button to accept your setting and then press the **MENU** button.

- [On] is the factory default.
- It does not beep if you mute the projector sound with the **MUTE** button on the remote control.

Prohibiting the Projector Operation

[Key lock]

- | | |
|----------------------------------|-------------------------------------|
| <input type="radio"/> HDMI | <input type="radio"/> COMPONENT |
| <input type="radio"/> DIGITAL PC | <input type="radio"/> VIDEO/S-VIDEO |
| <input type="radio"/> ANALOG PC | <input type="radio"/> USB |

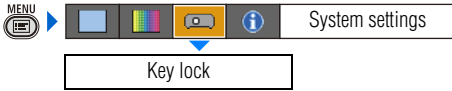

You can prohibit the operation of the projector from either the top control or remote control.

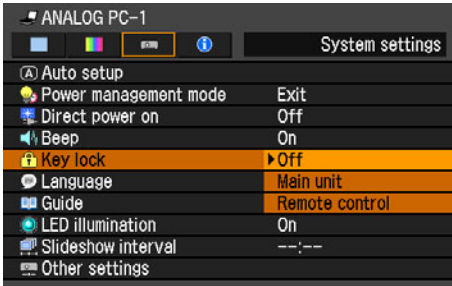

Off	Disables the key lock.
Main unit	Prohibit the operation from the main unit. Use the remote control.
Remote control	Prohibit the operation from the remote control. Use the main unit.

Press the **OK** button to accept your setting and then press the **MENU** button.

- [Off] is the factory default.

! The key lock function becomes effective from the moment the **OK** button is pressed after selecting [Main unit] or [Remote control]. Be sure to press the **OK** button on the top control or remote control which is not locked.

To Unlock Key Lock Function

Turn off the projector and unplug the power plug. Hold down the **OK** button on the top control and connect the power plug. Make sure to keep holding down the **OK** button until a beep sounds. The key lock is unlocked.

Selecting a Display Language

[Language]

- | | |
|----------------------------------|-------------------------------------|
| <input type="radio"/> HDMI | <input type="radio"/> COMPONENT |
| <input type="radio"/> DIGITAL PC | <input type="radio"/> VIDEO/S-VIDEO |
| <input type="radio"/> ANALOG PC | <input type="radio"/> USB |

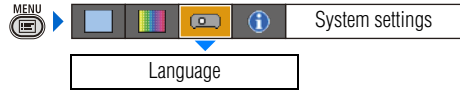

You can select the language in which the menu is displayed.



Use [\wedge] / [\vee] / [$<$] / [$>$] to select the language to be used in the menu, then press the **OK** button.

English	English
Germany	Deutsch
French	Français
Italian	Italiano
Spanish	Español
Portuguese	Português
Swedish	Svenska
Russian	Русский
Dutch	Nederlands
Finnish	Suomi
Norwegian	Norsk
Turkish	Türkçe
Polish	Polski
Hungarian	Magyar
Czech	Čeština
Danish	Dansk
Arabic	إنجليزي
Chinese (Simplified)	中文简体
Chinese (Traditional)	中文繁體
Korean	한국어
Japanese	日本語

When the setting is completed, press the **MENU** button.

Showing/hiding the Guide Screen

[Guide]

- | | |
|----------------------------------|-------------------------------------|
| <input type="radio"/> HDMI | <input type="radio"/> COMPONENT |
| <input type="radio"/> DIGITAL PC | <input type="radio"/> VIDEO/S-VIDEO |
| <input type="radio"/> ANALOG PC | <input type="radio"/> USB |

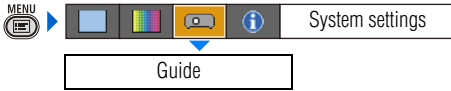

You can select whether to show or hide the guide screen which explains operations.

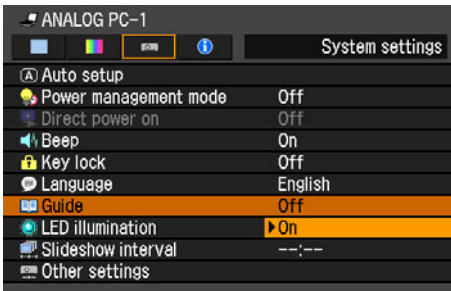

Off Hides the guide screen.

On Shows the guide screen.

Press the **OK** button to accept your setting and then press the **MENU** button.

- [On] is the factory default.
- The guide screen is shown when:
 - Power is turned off by pressing the **POWER** button (P68).
 - No input signal can be detected (P51).
 - An invalid button is pressed in the [BLANK], [FREEZE], or [D.ZOOM] mode (P70, 72).

Turning on/off LED Illumination

[LED illumination]

- | | |
|----------------------------------|-------------------------------------|
| <input type="radio"/> HDMI | <input type="radio"/> COMPONENT |
| <input type="radio"/> DIGITAL PC | <input type="radio"/> VIDEO/S-VIDEO |
| <input type="radio"/> ANALOG PC | <input type="radio"/> USB |

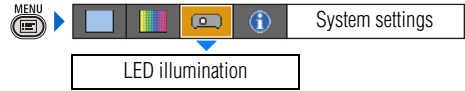

You can select whether to turn on or off LED illumination (P28).

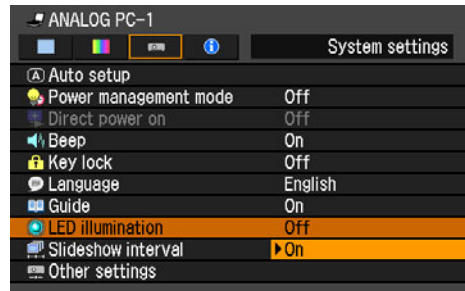

Off Disables the LED illumination.

On Enables the LED illumination.

Press the **OK** button to accept your setting and then press the **MENU** button.

- [On] is the factory default.
- LED illumination is unrelated to turning on/off of the **POWER** or **WARNING** lamp.

Setting for Slideshow (SX80 II)

[Slideshow interval]

<input type="checkbox"/> HDMI	<input type="checkbox"/> COMPONENT
<input type="checkbox"/> DIGITAL PC	<input type="checkbox"/> VIDEO/S-VIDEO
<input type="checkbox"/> ANALOG PC	<input type="checkbox"/> USB

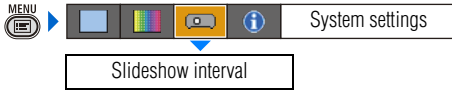

You can project the images stored in a PictBridge-compatible device (P114) or a USB flash memory (P118) in the slideshow.

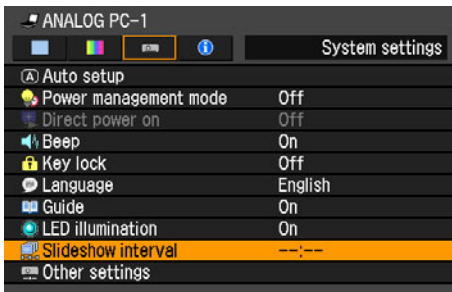

Use [\leftarrow] / [\rightarrow] to set the interval (minutes: seconds) of projection (60 minutes = maximum).

Set [-- : --] if no slideshow is performed. When the setting is completed, press the **MENU** button.

- [-- : --] is the factory default.
- The maximum length of slideshow time is 60 minutes (60:00).
- Use the USB file browser for the projection from the USB flash memory. For more details, refer to the page 120.

Setting up the Remote Control Channel

[Other settings] - [Remote control]

<input type="radio"/> HDMI	<input type="radio"/> COMPONENT
<input type="radio"/> DIGITAL PC	<input type="radio"/> VIDEO/S-VIDEO
<input type="radio"/> ANALOG PC	<input type="radio"/> USB

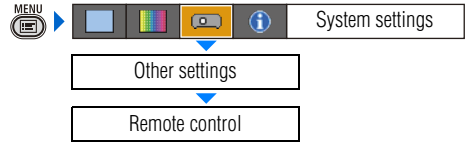

You can set different channels to different remote controls, if you use two projectors at the same time.

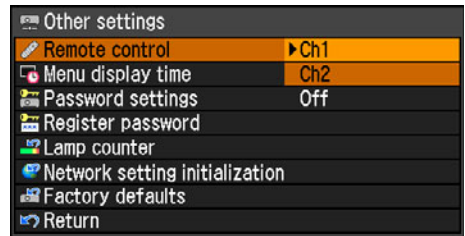

Ch1 Select the channel of the remote control used for this projector, and press the **OK** button.

Ch2 button.

Press the **OK** button to accept your setting and then press the **MENU** button.

- The factory defaults is [Ch1] for both projector and remote control.
- After changing the channel on the menu, be sure to change the channel of the remote control, too.

Selecting a Channel on the Remote Control

You can change the channel on the remote control as follows:

Ch1 Press the **OK** button and [\wedge] for 3 seconds at the same time.

Ch2 Press the **OK** button and [\rightarrow] for 3 seconds at the same time.

Extending the Menu Display Time

[Other settings] - [Menu display time]

- HDMI
- DIGITAL PC
- ANALOG PC
- COMPONENT
- VIDEO/S-VIDEO
- USB

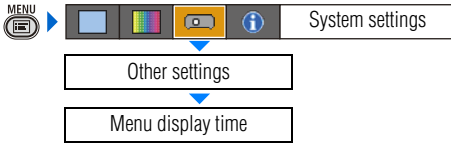

You can extend the menu display time, which is 30 seconds usually, to 3 minutes.

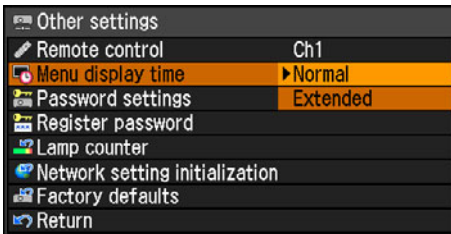

Normal The menu is displayed for 30 seconds.

Extended The menu is displayed for 3 minutes.

Press the **OK** button to accept your setting and then press the **MENU** button.

- [Normal] is the factory default.
- You cannot extend the display time for the window indicating the completion of Auto setup (P53), the guide window (P106), the lamp replacement window (preparation) (P145), or the lamp replacement window (warning) (P145).
- You cannot use the button holding operation except when you adjust the image size (P58) or focus (P59).

Setting a Password

[Other settings] - [Password settings]

- HDMI
- DIGITAL PC
- ANALOG PC
- COMPONENT
- VIDEO/S-VIDEO
- USB

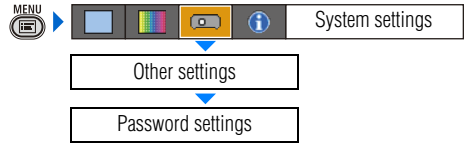

Disables the projector unless the correct password is entered.

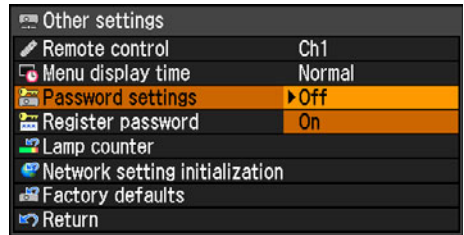

Off The projector can be used even if no password is entered.

On The projector cannot be used unless you enter your password.

Press the **OK** button to accept your setting and then press the **MENU** button.

- [Off] is the factory default.
- You cannot set [On] unless you have completed [Register password].

Once you set a password, the password entry screen appears at power-on. Enter a 4-digit password with [Λ] / [∇] / [<] / [>]. If the password is valid, the projection starts. If you enter a wrong passwords three times, the power will be turned off.

- The power is also turned off if no password is inputted for 3 minutes.

To Cancel the Password

Turn off the projector and unplug the power plug. Hold down the **MENU** button on the top control and connect the power plug. Make sure to keep holding down the **MENU** button until a beep sounds. The password is cancelled (the registered password is also reset).

Registering a Password

[Other settings] - [Register password]

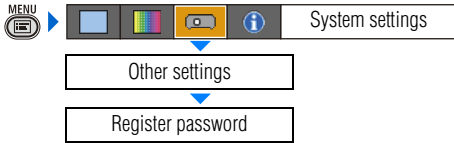

You can register a password for starting projection.

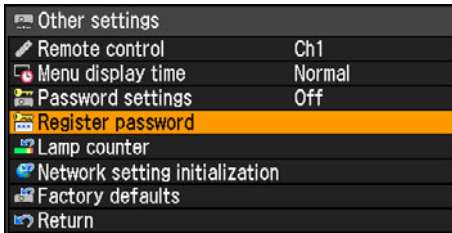

Press the **OK** button after selecting [Register password], and the following screen for registering a password appears:

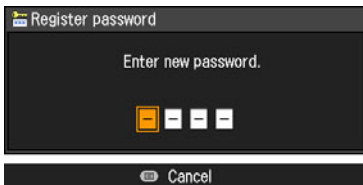

Enter a 4-digit password using [\wedge] / [\lt] / [\vee] / [\gt] (e.g., $\wedge\wedge\wedge\wedge$, $\lt\lt\lt\lt$, $\wedge\vee\lt\gt$). The 4-digit password is entered from the left to right digits, the password is automatically registered.

- Press the **MENU** button to abort the registration.

Resetting the Lamp Counter

[Other settings] - [Lamp counter]

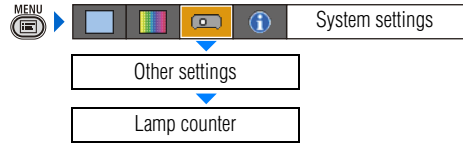

You can reset the lamp counter that indicates the timing to replace the projector when you replace it.

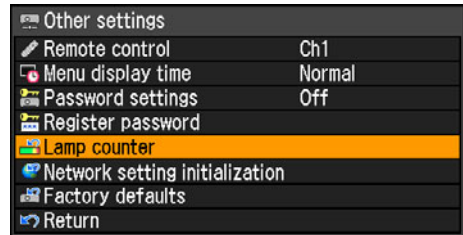
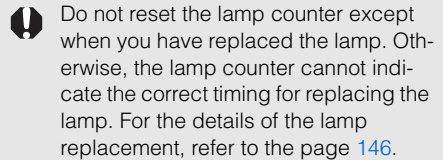

Press the **OK** button after selecting [Lamp counter], and the lamp counter is displayed.

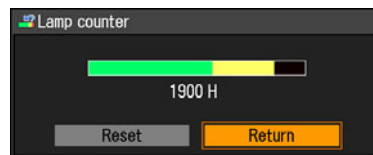

Select the [Reset] and press the **OK** button.

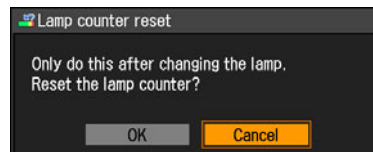

Select [OK] on the screen for confirmation, press the **OK** button, and the lamp counter is reset.

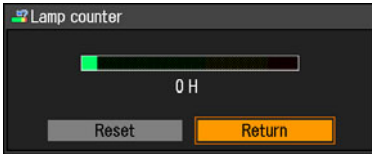

Press the **MENU** button.

■ About the Display of the Lamp Counter

The lamp counter displays the hours of use of the lamp in the following way:

Less than 1,800 hours

Displayed in green bar.

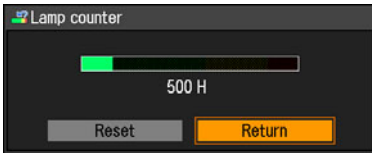

1,800 – less than 2,000 hours

Displayed in green and yellow bar.

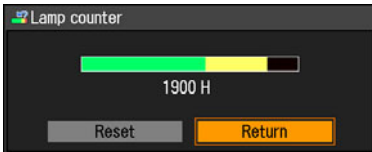

For 1,800 – less than 2,000 hours, a message "Obtain a new lamp." appears when power is turned on.



Over 2,000 hours

Displayed in green, yellow and red bar.

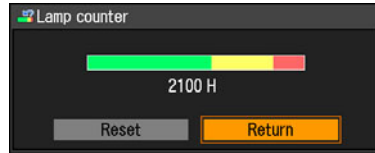

A message "Replace with the new lamp." appears when power is turned on.

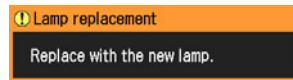

Initializing network settings (SX80 II)

[Other settings] - [Network setting initialization]

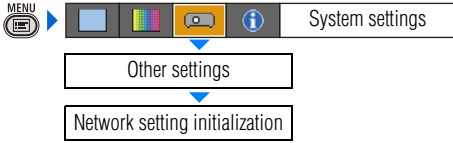

You can Initialize the network settings.

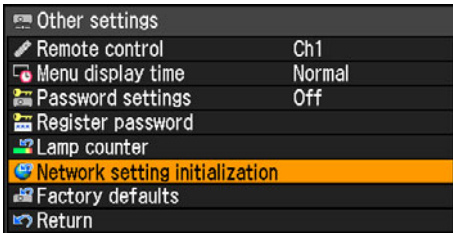

Press the **OK** button after selecting [Network setting initialization], and the following screen for confirmation appears:

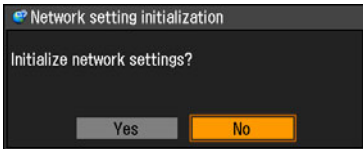

Yes	The network settings is initialized.
No	Initialization is aborted.

Press the **OK** button to accept your setting and then press the **MENU** button.

- Initialized are "IP address" and other items set in "Connecting the Projector to Network (SX80 II)" (P125).
- You can do this initialization also from a Web browser. (P134)

Resetting to the Default Setting

[Other settings] - [Factory defaults]

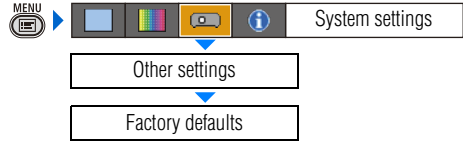

You can reset the menu item settings and restore the system settings to the factory defaults.

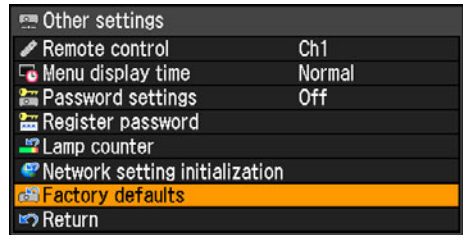

Press the **OK** button after selecting [Factory defaults], and the following screen for confirmation appears:

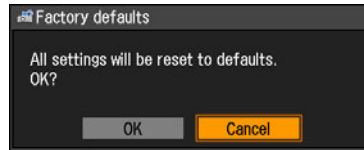

OK	Settings are reset to default.
Cancel	Settings are not reset to default.

Press the **OK** button to accept your setting and then press the **MENU** button.

- This function cannot reset the value of [Lamp counter], [Language], [Remote control], [Input signal] and [Network setting] to default.
- For factory defaults settings, refer to the page 164 - 166.

Checking the Information of the Projector

[Information]

- HDMI
- DIGITAL PC
- ANALOG PC
- COMPONENT
- VIDEO/S-VIDEO
- USB



You can confirm the information about the signal types of the images projected and other projector-specific information.

SX80 MarkII

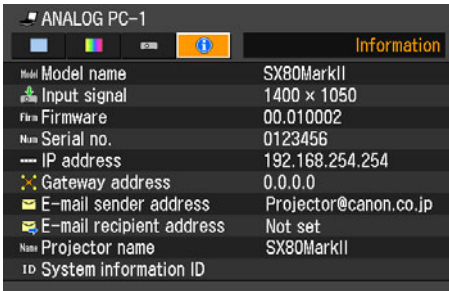

SX800

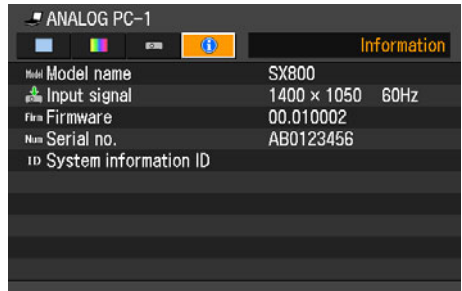

Information shown

Item	Meaning
Model name	Model name of this projector
Input signal	Details of the input signal currently selected "Type of signal", "resolution of signal", "frequency" and other information is shown.
Firmware	Current firmware version
Serial no.	Serial number unique to this projector
IP address (SX80 II)	Details of the network settings (P126) [Not set] is shown for an item having no settings.
Gateway address (SX80 II)	
E-mail sender address (SX80 II)	
E-mail recipient address (SX80 II)	
Projector name (SX80 II)	
System information ID	This is an item of system information. Normally this is not displayed.

Projecting an Image from a Digital Camera or an USB Flash Memory (SX80 II)

Table of Contents

Safety Instructions

Before Use

Projecting an Image

Useful Functions Available During a Presentation

Setting Up Functions from Menus

Projecting an Image from a Digital Camera or an USB Flash Memory (SX80 II)

Connecting the Projector to Network (SX80 II)

Appendix

Index

Projecting an Image from a Digital Camera (SX80 II)

SX80 MarkII supports PictBridge. You can directly project an image by connecting the projector with a PictBridge-compatible digital camera, digital video camera or camera-equipped mobile phone (hereinafter called "PictBridge-compatible device").

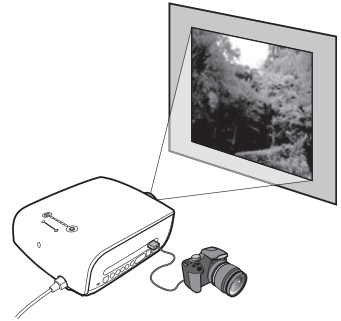

Connectable Cameras

PictBridge is an industry standard enabling the direct printing of images from a digital camera, digital video camera, camera-equipped mobile phone, etc. using a cable without the computer.

With this projector, you can directly project an image by connecting a PictBridge-compatible device and by using the same operation as that of printing.



Cameras bearing this mark supports PictBridge.

For the up-to-date information regarding PictBridge, visit Canon's website (http://pbdb.jp.canon.com/pictbridge_e/) or PictBridge's website (http://www.cipa.jp/pictbridge/index_e.html).

Connecting a Digital Camera

- 1 Turn the projector power on.
- 2 Switch the input signal to [USB].
Press the **INPUT** button, select [USB] with [\wedge] / [\vee] buttons, and press the **OK** button.

Remote control

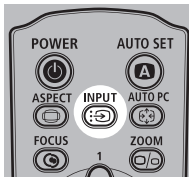

Top control

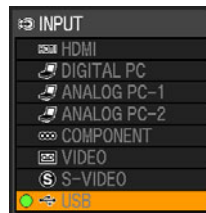
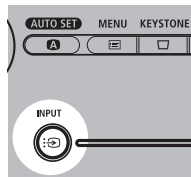

If you switch to [USB] when a PictBridge-compatible device is not connected or not powered on, the screen as shown in the right appears.

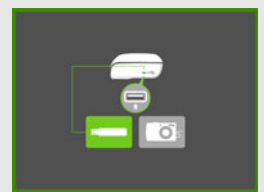

3 Connect a PictBridge-compatible device with the projector using a USB cable.

The terminal form of the device varies depending on the model. Refer to the User's Manual for the relevant equipment.

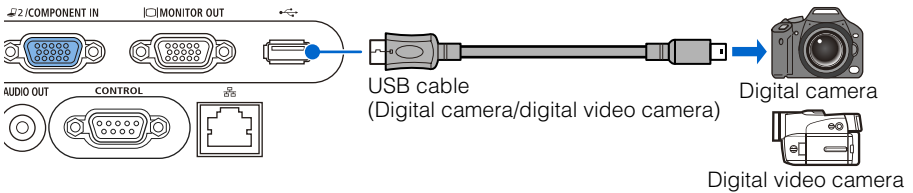

4 Turn on the power of the PictBridge-compatible device.

When the communication is ready between the projector and the PictBridge-compatible device, the following mark appears.

With Canon digital camera



With non-Canon digital camera

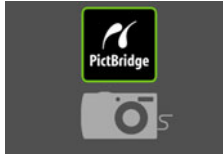

If the projector does not recognize the device or communication is disabled, the screen as shown in the right appears.

If a PictBridge-compatible device is connected, pull out the USB cable and connect it again.



If the screen as shown in the right (USB file browser) appears, the device supports the USB mass storage class (serves as an external hard drive to Windows computers), and you can project an image according to the system. For more details, refer to the page 118.

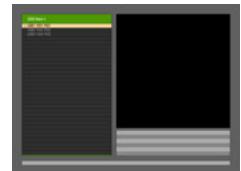

- Use a fully-charged battery for PictBridge-compatible device.
- Do not disconnect the cable until projection is ended unless the PictBridge-compatible device allows to do so. For the removal procedure of the cable, refer to the User's Manual for the PictBridge-compatible device.

5 Operate the PictBridge-compatible device

Operate the PictBridge-compatible device to start "printing".

The image is transferred to the projector, and projected on the screen.

- You can select from [Single print (project single image)], [Continuous print (project all images continuously)], and [DPOF print (project specified image)]. With [DPOF print], up to 999 images can be specified for projection.
- To view the next image with [Continuous print] and [DPOF print] selected, press the OK button.

Operating the Projected Image

When images are projected, you can perform the following operations.

■ Switching to the Next Image

If you have specified multiple images for printing with the digital camera, you can switch to the next image by pressing the **OK** button.

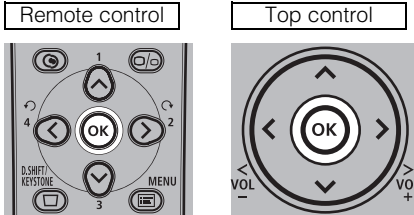

- You cannot switch to the previous image with the projector operation. To switch to the previous image, you must retry the print command with the digital camera.
- Even if a slideshow is running, you can switch to the next image by pressing the **OK** button.

■ Rotating an Image

You can rotate the image by 90 degrees to the left or to the right by pressing [**<**] / [**>**].

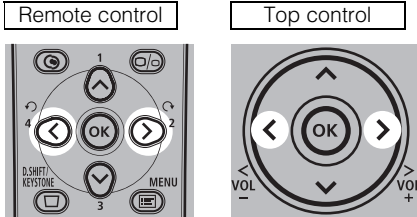

- Even if a slideshow is running, you can rotate the image by pressing [**<**] / [**>**].
- If the image contains rotational information, the image is rotated to an appropriate direction automatically.

Running a Slideshow

You can run a slideshow that projects multiple images stored in the digital camera at certain intervals.

■ Setting a Slideshow Interval

By setting projection intervals in [Slideshow interval] from the menu, you can run a slideshow of the images (with PictBridge or from a USB flash memory) connected via USB. Set the slideshow interval by following the steps below.

- 1 Press the MENU button to display the menu.

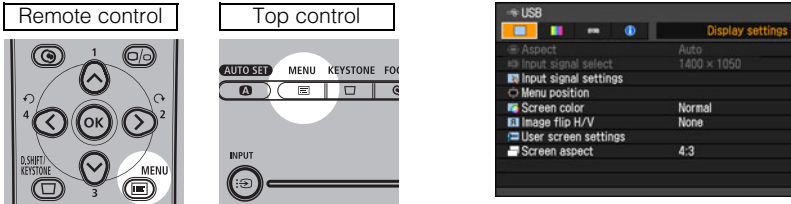

- 2 Select [System settings] tab with [←] / [→], and select [Slideshow interval] with [↑] / [↓].

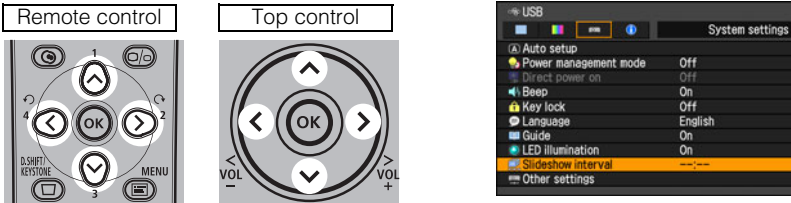

- 3 Set the interval (minute:second) other than "--:--" with [←] / [→]. To stop the slideshow, set as "--:--".

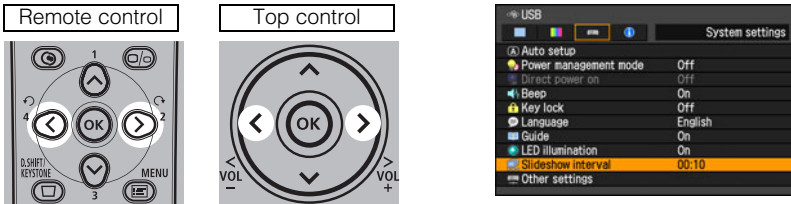

- 4 Press the MENU button to exit the menu. It may take a certain time depending on the screen size.

■ Finishing projection

To finish projecting images using PictBridge, turn off the power to the PictBridge enabled equipment. Then, remove the USB cable from the equipment.

Projecting Data on USB Flash Memory (SX80 II)

You can connect a USB flash memory to the projector for direct projection of the images (saved in JPEG format) saved in the USB flash memory.

- Images saved only in JPEG format are available for projection.

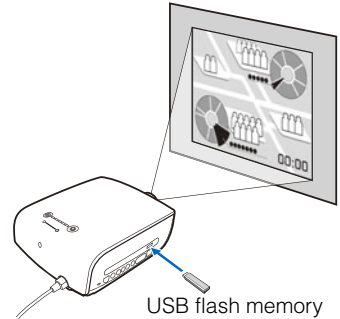

Connectable USB Devices

With this projector, you can connect the USB devices (general USB flash memories or USB-connected hard disks) that support the mass storage class (serves as an external hard drive to Windows computers).

Also, you can connect various memory cards via USB memory card readers.

You can also connect a digital camera or digital video camera that supports a USB mass storage class mode for image projection.

Connecting a USB Flash Memory

- 1 Turn the projector power on.
- 2 Switch the input signal to [USB].
Press the **INPUT** button, select [USB] with [\wedge] / [\vee] buttons, and press the **OK** button.

Remote control

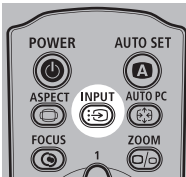

Top control

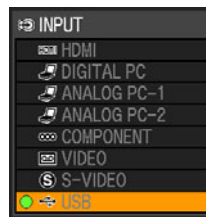
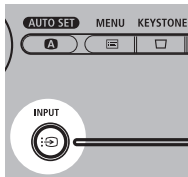

If you switch to [USB] when a USB flash memory is not connected or the hard disk is not powered on, the screen as shown in the right appears.

If the projector recognizes a USB flash memory, The "USB file browser" appears.

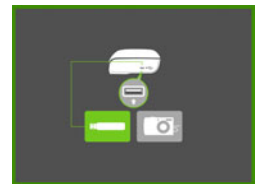

3 Connect a USB flash memory.

Connect a USB flash memory to the USB terminal.

Use a USB cable to connect a digital camera or USB memory card reader.

Be sure to use the USB cable supplied with the equipment connected to the projector.

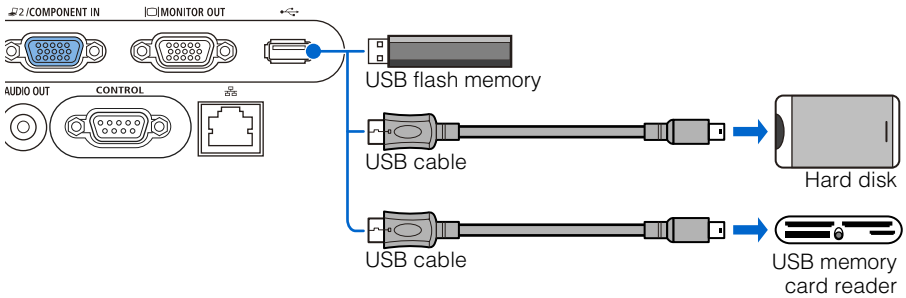

If the projector recognizes a USB flash memory, The "USB file browser" appears.

- Only the drive which has been set in advance is displayed.
- If multiple memory devices are attached to a multiple-card reader, the folder up one level in the hierarchy is displayed.

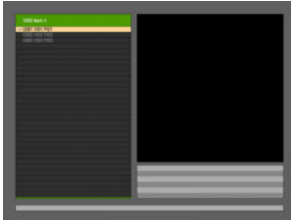

If connection to the USB flash memory fails, the screen as shown in the right appears.

Disconnect the USB flash memory, and connect it again.

If the projector does not recognize the device, the screen as shown in the right appears.



- If a USB hub is connected, the screen as shown in the right appears.
- You cannot connect a USB hub to this projector.
- When connecting a device which consumes large amount of power such as USB hard disk, use a commercial power supply.
- If the power supplied from the USB terminal is insufficient, malfunction of the USB flash memory may result or the projector unable to recognize the device.



Description of USB File Browser

If a USB flash memory is connected to the projector, the USB file browser appears. In the USB file browser, you can select the image file to be projected by operating the file list in the USB memory device.

List title

Drive name currently selected
Representation varies depending on the manufacturer and/or model.



Page number of the file list currently displayed
(Current page number/total number of pages)
You can page up and down with [<] / [>].

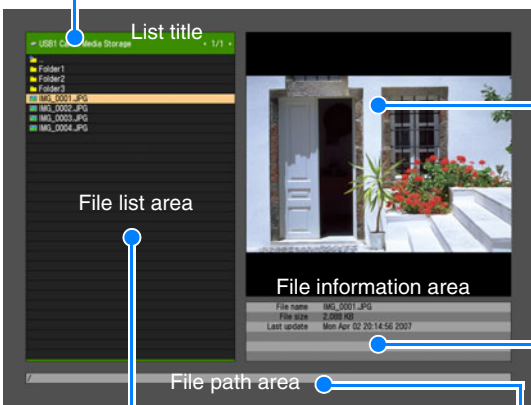

List title

File list area

Preview area

File information area

File path area

Preview area

Image selected in the file list appears with reduced size. If a folder is currently selected, the folder icon appears.



File information area

Information of the image selected in the file list appears here.

- File name
- File size
- Date time original (date and time of when the image was taken) ("Last update" may appear instead.)
- Image size (resolution)
- Model
- Shooting information (shutter speed, diaphragm, ISO sensitivity)

File list area

File list within the folder appears in the order of file name. Select an image file or folder with [^] / [v].

-  Folder
-  Available image file

File path name

Path name of the image selected in the file list appears here.

Selecting an Image for Projection

This section describes the steps for selecting an image in the USB file browser and projecting on the screen.

■ Selecting a Drive

If a USB flash memory is connected, skip this step.

If a USB memory card reader having multiple memory slots is connected, the drive (memory slot) list is displayed in the file list.

Select the drive in which the memory card is inserted with [^] / [v], and press the **OK** button.

Remote control



Top control

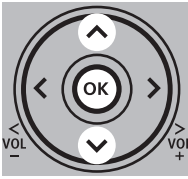

- Active drives are displayed in white text, while inactive drives are grayed out.
- Icons indicate the memory card status of each drive. (They differ depending on the connected equipment.)



Example 1) Memory card is inserted and recognized properly.



Example 2) Memory card is inserted but cannot be recognized.

The file system is destroyed or the projector cannot recognize its format.

■ Selecting a Folder

If the image file is located in a folder, select the folder with [^] / [v], and press the **OK** button.

Remote control



Top control

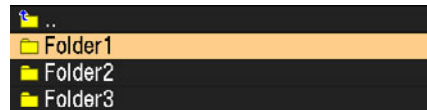
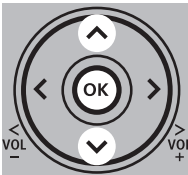

- To return to upper hierarchy, select   .. and press the **OK** button.

■ Selecting an Image File for Projection

1 Select an image file with [^]/[v].

Remote control

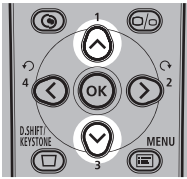

Top control

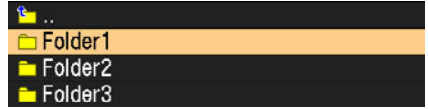
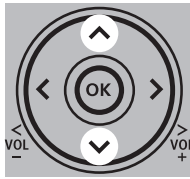

The selected image appears in the preview area with reduced size.

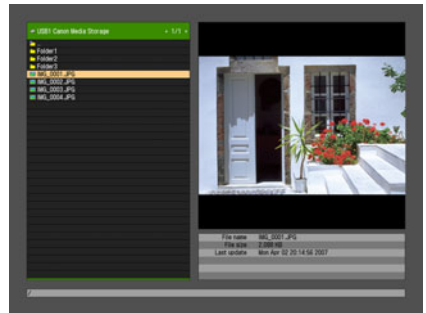

- To return to upper hierarchy, select  .. and press the OK button.

2 Press the OK button to project the image in full screen.

Remote control



Top control

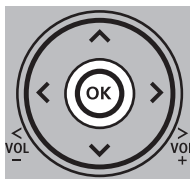

- To return to the USB file browser, press the OK button.

Operating the Projected Image

When images are projected, you can perform the following operations.

■ Switching to the Previous/Next Image

If multiple image files are saved in a folder, you can switch to the previous/next image by pressing [\wedge] / [\vee].

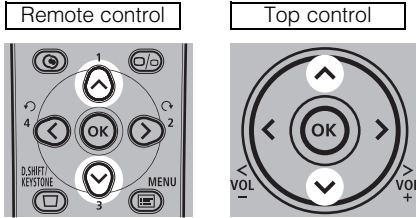

- Even if a slideshow is running, you can switch to the previous/next image by pressing [\wedge] / [\vee].

■ Rotating an Image

You can rotate the image by 90 degrees to the left or to the right by pressing [$<$] / [$>$].

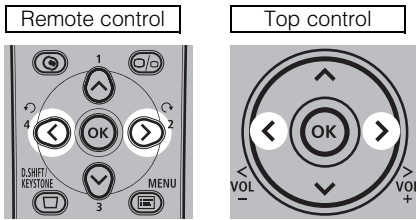

- Even if a slideshow is running, you can rotate the image by pressing [$<$] / [$>$].
- If the image contains rotational information, the image is rotated to an appropriate direction automatically.

■ Returning to the USB File Browser

To return to the USB file browser, press the OK button.

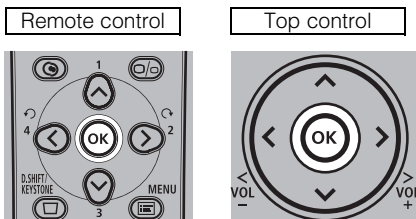

Running a Slideshow of Data saved in a USB Flash Memory

You can run a slideshow that projects multiple images stored in a USB flash memory at certain intervals.

■ Creating an Image File Folder

In the slideshow, image files in a folder are displayed in the alphabetical order of file name. Therefore, create a folder in the USB flash memory and save the image files to be projected in the slideshow in advance.

To start a slideshow, select and project the first image file in a folder in the full-screen display mode using the USB file browser.

If the "slideshow interval" described below has been set, the image files in a folder are automatically projected in sequence.

■ Setting a Slideshow Interval

To run a slideshow, set the time interval in [Slideshow interval] from the menu in advance. For the details of the setting step, refer to "Running a Slideshow" on page [117](#).

Connecting the Projector to Network (SX80 II)

Table of Contents

Safety Instructions

Before Use

Projecting an Image

Useful Functions Available During a Presentation

Setting Up Functions from Menus

Projecting an Image from a Digital Camera or an
USB Flash Memory (SX80 II)

Connecting the Projector to Network (SX80 II)

Appendix

Index

Setting an IP Address (SX80 II)

It is possible to send an error notification e-mail (P135) from the projector to the computer when you connect the projector to the network.

To connect via the network, an IP address must be assigned to the projector. Set an IP address by following the steps below. (The examples shown are Windows XP screenshot images.)

■Setting IP Address of the Computer

- 1 Connect the projector and a computer directly via a cross or straight type LAN cable.

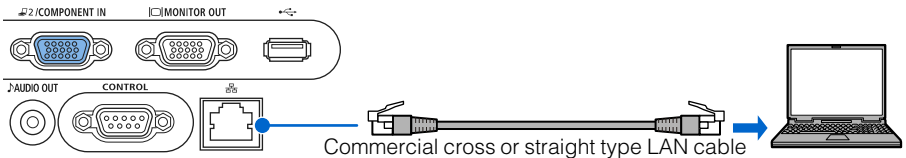

- 2 Turn on the power of the projector and computer.
- 3 Open [Control Panel] from the [Start] menu, then select [Network and Internet Connections] - [Network Connections].
- 4 Right-click [Local Area Connection], and open [Properties].
- 5 Select [Internet Protocol (TCP/IP)] and click the [Properties] button. Take notes of the original network settings (IP address, subnet mask, DHCP settings, etc).
- 6 Select [Use the following IP address] and set as follows:
[IP address]: 192.168.254.1
[Subnet mask]: 255.255.255.0

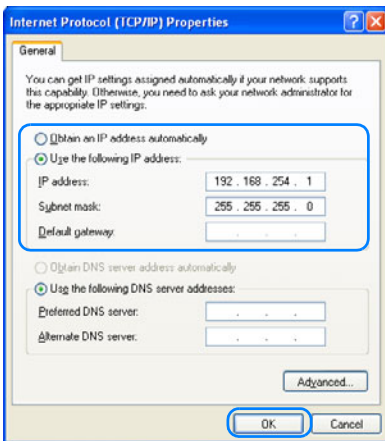

- 7 When you have specified the settings, click the [OK] button and then click the [OK] button on the [Local Area Connection Properties] window to close it.

■ Resetting the IP Address Setting of the Computer

- 1** Turn off the projector and remove the LAN cable.
- 2** Follow the step 3 to 6 to restore the network setting to the original setting.

Setting Network (SX80 II)

■ Displaying the Network Configuration Screen

- 1 Turn on the computer and projector.
- 2 Launch a web browser, enter "http://192.168.254.254" in the address bar, and press the Enter key.
The password input screen appears.
The supported web browsers is Microsoft Internet Explorer 6 or later.
- 3 In the password input screen, enter "root" for [User name] and "system" for [Password] and click the [OK] button.

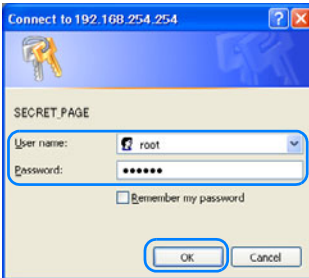

The projector network configuration screen appears on the web browser. The following information is displayed.

- [Projector name]: The name of the projector on the network
- [Location]: The location of the projector
- [MAC address]: The MAC address of the projector
- [IP address]: The IP address of the projector
- [Power Status]: The power status of the projector
- [Lamp Time Normal Mode]: The total lamp used time in its normal mode
- [Lamp Time Quiet Mode]: The total lamp used time in its quiet mode
- [Lamp Time Converted]: The total lamp used time (converted value)
- [Filter Time]: The total filter used time



Click the [Settings] button to display the menu screen.

■ Setting the Network

- 1 In the menu screen, click [Password], input the new user name and password, and click the [OK] button.

Setting items:

[User name]: The user name for logging in the network

[New password]: The new password

[Confirm new password]: The password for confirmation

SX80 Mark II SX80 Mark II
Password

Apply Initialize

OK Cancel

User name: []

New password: [] 4 - 15 characters

Confirm new password: []

TCPIP
Mail
Mail auth
Send test mail
SNMP
Projector info

- 2 Click [TCP/IP], enter appropriate values in the following field, and click the [OK] button.

Setting items:

[IP address]: The IP address of the projector

[Subnet mask]: The subnet mask of the projector

[Default gateway]: The default gateway of the projector

SX80 Mark II SX80 Mark II
TCP/IP

Apply Initialize

OK Cancel

IP address: 192.168.254.254

Subnet mask: 255.255.255.0

Default gateway: 0.0.0.0

TCPIP
Mail
Mail auth
Send test mail
SNMP
Projector info

3 Click [Mail], enter appropriate values in the following field for the error report, and click the [OK] button.

Setting items:

- [To:]: The E-mail address to which the error report is sent (Within 63 alphanumeric characters)
- [Cc:]: The E-mail address to which the carbon copy of the error report is sent (Within 63 alphanumeric characters, can be omitted)
- [From:]: The sender of the E-mail (the projector)
- [SMTP server IP address]: The IP address of the available SMTP mail server
- [SMTP server port number]: The port number of the available SMTP mail server
- [SNTP server IP address]: The IP address of the available SNTP mail server (can be omitted)
- [Time zone]: The time zone of the installation site
- [Mail resend interval]: The E-mail resending interval at a transmission failure
Setting range: 0 - 59 seconds (the factory default: 10 seconds)
- [Mail resend times]: The number of E-mail resending attempts at a transmission failure
Setting range: 0 - 255 times (the factory default: 3 times)
- [Error report]: Turning ON/OFF the error report sending function (the factory default: [OFF])



4 If the SMTP mail server authentication is required, click [Mail auth], enter appropriate values in the following field, and click the [OK] button.

Select one of the following four authentication method in [Mail authentication]. Select [OFF] if the mail authentication is not required (the factory default is [OFF]).

[LOGIN (SMTP authentication)], [CRAM-MD5 (SMTP authentication)], [USER/PASS (POP before SMTP)], [APOP (POP before SMTP)]

Setting items:

[User name]: The user name for the mail authentication

[Password]: The password for the mail authentication

[Confirm password]: The password for confirmation

[POP3 server IP address]: The IP address of the POP3 server

[POP3 server port number]: The port number of the POP3 server
(The factory default: 110)

[POP before SMTP response time]: The wait time between the POP3 authentication and the transmission to the SMTP mail server
(millisecond, the factory default: 300)

SX80 Mark II SX80 Mark II
Mail auth

Apply Initialize

OK Cancel

Mail authentication: POP before SMTP

User name	<input type="text"/>
Password	<input type="password"/>
Confirm password	<input type="password"/>
POP3 server IP address	0.0.0.0
POP3 server port number	110
POP before SMTP response time	300

Password
TCP/IP
Mail
Mail auth
SEND TEST MAIL
SNMP
Projector info

5 If you want to monitor the projector, click [SNMP], enter appropriate values in the following field, and click the [OK] button.

Select one of the following four SNMP version in [SNMP]. Select [OFF] if you don't want to monitor the projector.

(The factory default: [OFF])

[V1], [V2c], [V3 (MD5)], [V3 (DES, MD5)]

Setting items:

[Receive community]: The name of the community (user)

[Password]: The password for the community setting

[Confirm password]: The password for confirmation

[SNMP trap]: Conditions for sending the SNMP trap

[Trap IP address]: The IP address to which the SNMP trap is sent

[Trap community]: The name of the community (user) to which the SNMP trap is sent



What is the SNMP Agent Function?

This projector supports the SNMP (Simple Network Management Protocol) agent function that monitors the status of the projector. SNMP consists of the manager (a monitoring tool, your PC) and agent (a monitored target, the projector).

The information exchange group via SNMP is called "a community." The message which tells the status of the agent is called "a SNMP trap."

This projector has the following SNMP traps:

- Cold start: it tells the SNMP agent is under initialization.
- Warm start: it tells the SNMP agent is under reset (at the SNMP version upgrade).
- Authentication failure: it tells that it failed the SNMP authentication.
- Faulty lamp: it tells that a lamp-related error was occurred.
- Faulty power supply: it tells that a power supply-related error was occurred.
- Temperature abnormality: it tells that a temperature-related error was occurred.
- Lamp status change: it tells that the status of the lamp used time was changed.
- Faulty cooling fan: it tells that a cooling fan-related error was occurred.
- Faulty lamp cover: it tells that a lamp cover-related error was occurred.

- Filter message: it tells that the air filter has reached its replacement timing.
 - Unknown: it tells that an unknown error was occurred.
- Make sure to install the SNMP manager program on your PC before using the SNMP agent function.

Authentication and Encryption Protocols

SNMP V3 for the projector uses the DES-CBC for the authentication and encryption protocols.

- 6** Click [Projector info] and enter the projector name.
- You can input 1 to 63 alphanumeric characters.
 - The factory default is [SX80 MarkII].



- 7** Click [Location], enter the projector location, and click the [OK] button.
- You can input up to 63 alphanumeric characters.
 - The factory default is blank.
- 8** Click [Apply] when you have completed each menu.



Click the [OK] button when the following dialog box is displayed.



The network setting of the projector is now completed.

If you want to test the error report transmission, click [Send test mail].

■ Resetting the Network Setting

- 1 Click [Initialize] in the menu screen.



- 2 Click the [OK] button when the following dialog box is displayed.

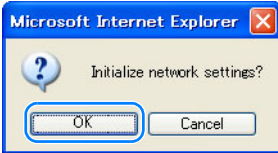

If you want to restore to the factory setting from the projector, perform [Network setting initialization] from the menu.

■ Error Notification Message

It sends the following message when an error occurs in the projector.

Error list

Errors related to temperature	Error name	Temperature abnormality
	Text	The temperature inside the projector is too high for some reason or the outside air temperature is higher than the specified one. If the problem is inside the projector, check whether the projector is installed and operated normally, turn off the projector to cool its inside, and retry projection. If the same warning occurs again, the projector may be defective. Contact your dealer.
Errors related to the lamp	Error name	Faulty lamp
	Text	The lamp has burnt out. Replace the lamp with a new one. If the same warning occurs again, the lamp drive circuit may be defective. Contact your dealer.
Errors related to the lamp cover	Error name	Faulty lamp cover
	Text	The lamp cover is open. Check whether the lamp cover is installed properly. If it is installed properly, the lamp cover detection switch may be defective. Contact your dealer.
Errors related to the cooling fan	Error name	Faulty cooling fan
	Text	The cooling fan or another component may be defective. Contact your dealer.
Errors related to the power supply	Error name	Faulty power supply
	Text	The voltage of part of the power supply is abnormally high or any other problem has occurred in the power supply. Contact your dealer.
Other types of errors	Error name	Unknown Error
	Text	Codes in hexadecimal numbers*

* Contact your Canon dealer.

■ Projector Control

1 Click the [Projector control] button on the network setting screen.



The projector control screen appears.

Controlled items:

- [Power]: Turn ON/OFF the projector (P49, P68)
- [Input]: Select an input signal (P54)
- [Aspect]: Select an aspect ratio (P62)
- [Image mode]: Select an image mode (P67)
- [Blank]: Blank out the image temporarily (P70)
- [Mute]: Mute the sound temporarily (P71)
- [Auto setup]: Perform the auto setup function (P52)
- [Auto PC]: Perform the auto PC function (P57)

- For [Input], [Aspect], and [Image mode], select an item and click the [Apply] button.
- Click the [Refresh] button to display the latest information.
- Click the [Back] button to return to the network setting screen.



- Do not use the [Back], [Forward], or [Refresh] button on your web browser when you control the projector. Using the web browser buttons may cause the projector to be malfunctioned. Be sure to use the buttons on the network setup window.
- Before terminating control of the projector, press the [Refresh] button to check whether the new setting is properly updated or not.

Appendix

Table of Contents

Safety Instructions

Before Use

Projecting an Image

Useful Functions Available During a Presentation

Setting Up Functions from Menus

Projecting an Image from a Digital Camera or an
USB Flash Memory (SX80 II)

Connecting the Projector to Network (SX80 II)

Appendix

Index

WARNING Lamp Flash Patterns

The WARNING lamp on the Control Panel flashes in red after the projector is turned off when there is a trouble in the projector.

- Wait until the cooling fan stops and disconnect the power plug from the AC outlet before dealing with the trouble.

Flash Pattern	Meaning	Countermeasure
One flash	Temperature, abnormality	The temperature inside the projector is too high for some reason or the outside air temperature is higher than the specified one. If the problem is inside the projector, check whether the projector is installed and operated normally, unplug the projector from the power outlet to cool down the inside of it and retry projection. If the air intake or exhaust vent is blocked, remove the obstacle. If the same warning occurs again, the projector may be defective. Contact your dealer.
Two flashes	Faulty lamp	The lamp has burnt out. Replace the lamp with a new one. If the same warning is experienced again, the lamp drive circuit may be defective. Contact your dealer.
Three flashes	Faulty lamp cover	The lamp cover is open. Unplug the projector from the power outlet, then install the lamp cover and turn on the projector again. If the lamp cover has been installed properly, the lamp cover detection switch may be defective. Contact your dealer.
Four flashes	Faulty cooling fan	The cooling fan or another component may be defective. Unplug the projector from the power outlet, then plug it to the outlet and turn on the projector again. Contact your dealer if the same warning is given.
Five flashes	Faulty power supply	The abnormal voltage is applied to some parts in the power supply or any other failure may be occurred. Unplug the projector from the power outlet, then plug it to the outlet and turn on the projector again. Contact your dealer if the same warning is given.

Symptoms and Solutions

■ You cannot turn on the projector.

Cause	Countermeasure
The power cord is not connected correctly.	Check whether the power cord is connected correctly. (P49) Check that [Key lock] is not enabled. (P105)
The power cord has just been connected.	You cannot turn on the projector until the POWER indicator turns red after connecting the power plug. (P49)
The lamp cover is open.	Unplug the power cord from the power outlet and correctly install the lamp cover and then turn on the projector again.
The safety device has activated because you put the projector in the carrying bag during the cooling fan was rotating.	When the safety device is active, the POWER lamp does not turn on when you connect the power cord. You cannot release the safety device. Contact your dealer.
The safety device is activated because the air intake or the exhaust vent is blocked and the internal temperature of the projector is increased.	When the safety device is active, the POWER lamp does not turn on when you connect the power cord. You cannot release the safety device for safety reason. Remove any obstacle that is blocking the air intake or exhaust vent and contact your dealer.

■ You cannot project an image from the projector.

Cause	Countermeasure
Any connection cable is connected incorrectly.	Check whether the projector is connected to the computer or AV equipment correctly. (P38, P39, P54)
20 seconds have not passed since the projector was turned on.	When the projector is turned on, the Opening window is displayed for approximately 20 seconds. To project an image immediately, press the OK button on the remote control or top control. (P49)
No image is sent from the AV equipment.	Check that an image is played on the connected digital camera, video camcorder, DVD, etc.
The wrong video terminal or signal type is selected.	Check that the correct video terminal and signal type are selected. (P38, P39, P54)
No input signal type has been selected.	Press the INPUT button to select an appropriate input signal type. (P55)
The video signal type is incorrect.	Check whether the selected signal type is correct. (P80, P81, P150)
The BLANK function has been selected.	Press the BLANK button on the remote control. (P70)
No image is sent due to the problem in the computer.	Turn on the projector and computer in this order again.

Cause	Countermeasure
The external monitor output is not set on the notebook computer correctly.	Turn on the external monitor output on the notebook computer. To turn on the external monitor output, press the [LCD] or [VGA] function key or a key with an icon for the external monitor, while holding down the [Fn] key on the keyboard of the notebook computer. (P51) The combination of keys used to perform this operation varies among computer manufacturers. For more detailed information, refer to the User's Manual that came with your computer.
The displayed image is not the same as that displayed on the computer.	Check whether the dual screen (multi-display) mode is selected on the computer. If the dual screen mode has been selected, change it to the simultaneous display mode on the computer. The output setting method varies among computer manufacturers. For more detailed information, refer to the User's Manual that came with your computer.
The lens cap is not removed.	Remove the lens cap.

■ A digital camera or USB flash memory is not recognized. (SX80 II)

Cause	Countermeasure
PictBridge is not supported.	Equipment not supporting PictBridge is not recognized. Refer to the User's Manual for the relevant equipment. (P114)
The mass storage class is not supported.	USB flash memory not supporting the mass storage class is not recognized. Refer to the User's Manual for USB flash memory. (P118)

■ You cannot hear sound.

Cause	Countermeasure
The audio cable is not connected correctly.	Check the cable connection of the audio cable. (P38, P39)
The MUTE function is enabled.	Press the MUTE button on the remote control. (P71)
The volume level is adjusted to the minimum.	Press the VOL button on the remote control or the VOL+ button on the top control to adjust the volume level. (P71)
An audio cable with a built-in resistor is used.	Use an audio cable without a built-in resistor.

■ The projected image is blur.

Cause	Countermeasure
The image is out of focus.	Adjust the focus. (P59)
The distance to the screen is too short.	Check whether the distance to the screen is appropriate. If the distance is shorter than approximately 1.2m (3.9'), the projector cannot focus on the screen. (P35, P151)
The projector is not placed straight in front of the screen.	Check whether the projector is placed obliquely to the screen. A slight error in the projection angle can be corrected through the keystone adjustment function. (P60)
The projector has been moved to a place where the temperature varies a lot.	When the projector is moved from a low-temperature place to a high-temperature place, condensation may form on the lens. The condensation will evaporate a while later and the projector will be able to project a normal image.
The lens is stained.	Clean up the lens. (P143)
The tracking is bad.	Adjust the tracking with the AUTO PC or Tracking function. (P57, P82)

■ You cannot project an image appropriately.

Cause	Countermeasure
The projected image is inverted in the vertical or horizontal direction.	The ceiling mounted/rear projection setting is incorrect. Check the [Image flip H/V] setting in the [Display settings] menu. (P87)
Using a VGA cable in which some pins are not connected.	<ul style="list-style-type: none"> Use a supplied VGA cable (for SX800). If you use a commercial VGA cable, make sure to use a cable in which all pins are connected.

■ The projector is forced to be turned off.

Cause	Countermeasure
The air intake or exhaust vent is blocked.	Check whether the air intake or exhaust vent is blocked. If the air intake or exhaust vent is blocked, the temperature inside the projector rises and the power is automatically turned off to protect the projector. (The WARNING lamp flashes once.) Wait until the internal temperature gets down, and then turn on the projector without blocking the intake and exhaust vents. (P24, P25, P49)
The air filter is dirty.	Check whether the bottom air filter is clogged with dust. If the air filter is clogged, clean or replace the air filter. (P144)
The lamp has exploded (or it is defective).	Check whether the lamp has exploded. If the lamp has exploded, replace the lamp according to "Lamp Handling Precautions" on page 18. Check the lamp by replacing it with a spare lamp if you have one. (P18, P145, P146)

Cause	Countermeasure
The operating temperature is inappropriate.	Check whether the operating temperature is 5 to 35°C. (P20) If you use the projector at 2300 meters or higher above sea level, contact your dealer.
Other reasons	The projector may be damaged. Contact your dealer.

■ You cannot operate the remote control.

Cause	Countermeasure
Batteries are not installed properly or they have run out.	Check whether batteries are installed correctly. If batteries are installed correctly, replace them with new batteries. (P31)
You are operating the remote control from the outside of the remote control operating range.	Check whether you are operating the remote control within the remote control operating range. (P31)
There is an obstacle between the projector and the remote control.	Remove the obstacle between the infrared remote receiver of the projector and the remote control or point the remote control to an obstacle-free path.
You are operating the remote control under an inappropriate operating environment.	Check whether the infrared remote receiver of the projector is exposed to direct sunlight or strong light of lighting apparatus. (P31)
The channel setting of the remote control does not match with the setting of the projector.	Check whether the channel setting of the remote control has been changed. You can check the [Remote control] setting in the [System settings] menu. (P107)
The key lock function is prohibiting the remote control operation.	Check whether [Key lock] is enabled to disable the remote control operation. In the System settings menu, set [Key lock] to [Off]. (P105)

Cleaning the Projector

Clean the projector frequently to prevent dust from settling on the surface. A dirty lens may ruin the quality of the projected image.



- The main unit is very hot immediately after turning off the projector. Wait until the projector cools down sufficiently (more than 1 hour) before cleaning the projector. Otherwise, you may get burned or injured.
- Before cleaning the projector, be sure to remove the power plug from the AC outlet. Otherwise, electric shock or fire may result.

Wipe the projector's main unit softly with a soft cloth.

If the projector is heavily soiled, soak the cloth in water with a small amount of detergent in it, squeeze the cloth very well, and then wipe the projector with it. After cleaning, wipe the projector with a dry cloth.



- Never use volatile cleaning liquid or benzine, as these may damage the finish of the projector.
- When using a chemical dust cloth, make sure to read the instructions thoroughly.
- When cleaning the projector's lens, use a commonly available air blower or lens cleaning paper. The lens surface is easily damaged, so do not use a hard cloth or tissues.

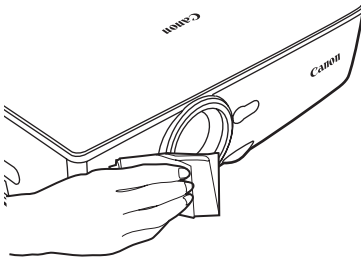

When Not Used for an Extended Period of Time

Be sure to attach the lens cap on the lens and store in the supplied carrying bag.

Cleaning and Replacing the Air Filter

An air filter is installed in the air intake vent on the bottom of the main body to protect the internal lens and mirror from dust. Should the air filter become clogged with dust, the projector may be damaged since it will block the air flow into the projector and raises the internal temperature of the projector. The following screen is displayed when turning on the projector if the air filter needs to be cleaned. Clean the air filter if such is the case.

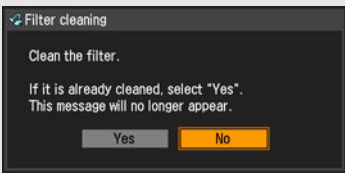

- Only [$<$], [$>$], the OK button, and the POWER button are available while this screen is displayed (When you press the POWER button, "Push POWER button again to turn off power." message appears).
- After this screen has been displayed for 10 seconds and disappeared, all buttons become operable.

■ Cleaning the Air Filter

- Turn the projector upside down, remove the cover by pushing the latch, remove the air filter, and clean it with a vacuum cleaner.
- When cleaning dust off the rear exhaust vent and bottom air intake vent, bring the vacuum cleaner nozzle close to them directly.
- If the above screen is displayed when turning on the projector after cleaning the air filter, select [Yes].

■ Replacing the Air Filter

Make sure to replace the air filter when replacing the lamp. Follow the following procedure when replacing the air filter.

- 1** Turn off the projector, disconnect the power plug from the AC outlet, and let the projector stand for at least 1 hour.
- 2** Remove the filter cover by pushing the position of the arrow.
- 3** Remove the air filter.
- 4** Install a cleaned or new air filter.
- 5** Install the filter cover securely without any space.

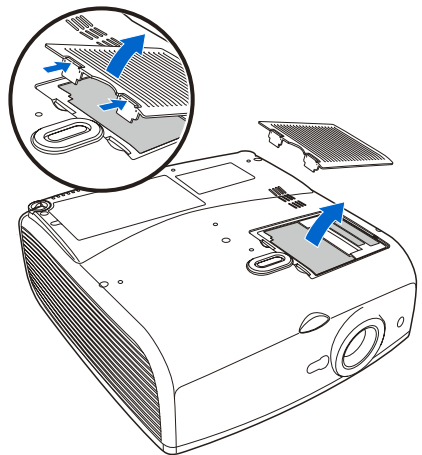

- Handle the air filter carefully. If damaged, the air filter will not work appropriately
- An air filter can be ordered from your dealer.

Replacing the Lamp

When the time of use of the lamp exceeds the certain amount of time, the following message (two types) is displayed for 10 seconds every time the projector is turned on.

1,800 - less than 2,000 hours



Prepare the new lamp when this screen is displayed.

- Only [**<**], [**>**], the **OK** button, and the **POWER** button are available while this screen is displayed.
- When you press the **POWER** button, "Push **POWER** button again to turn off power." message appears.

- After this screen has been displayed for 10 seconds and disappeared, all buttons become operable.
- This message will not be displayed again if you select [**Cancel**] in response to the message "Do you want to display this message again?".

Over 2,000 hours

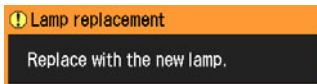

Replace the lamp by referring to the procedure on page 146 when this screen is displayed.

- Only the **POWER** button is available while this screen is displayed.
- When you press the **POWER** button, "Push **POWER** button again to turn off the power." message appears.

- After this screen has been displayed for 10 seconds and disappeared, all buttons become operable.
- You can check the time of use of the lamp in [Lamp counter] in the [System settings] menu (P109).

■ About the Replacing Lamp

This projector uses the following lamp.

Lamp type No.RS-LP05



- Be sure to use the specified lamp.
- A lamp can be ordered from your dealer.
- When replacing the lamp, turn off the projector, wait until the cooling fan stops, disconnect the power plug from the AC outlet, and let the projector stand for at least 1 hour. Otherwise, you may get burned because the main unit is very hot immediately after the projector is turned off.
- Do not touch the inner glass surface when you replace the lamp. Otherwise, the projector's performance may degrade.
- Make sure to handle the lamp carefully and correctly since it may explode if it is scratched or shocked. If a lamp explodes, follow the instructions under "If a Lamp Explodes" on page 18.
- Do not remove screws unless specified.

■ Replacing the Lamp

1 Turn off the projector, disconnect the power plug from the AC outlet, and let the projector stand for at least 1 hour.

2 As shown in the figure, insert a flat-head screwdriver in the gap and remove the lamp cover by raising it.

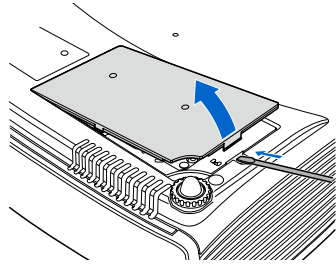

3 Loosen two screws with a phillips-head screwdriver and then pull up the handle.

* Pull up the handle as shown in the figure.

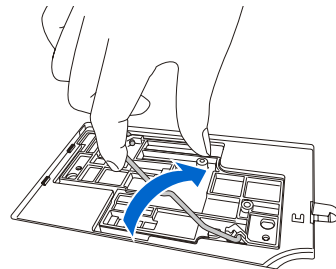

4 Remove the lamp while holding the center of the handle.

5 Fully insert a new lamp and secure it with two screws.

* After the installation, be sure to push down the handle.

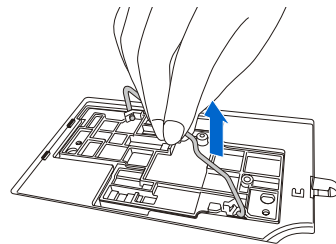

6 As shown in the figure, replace the lamp cover. Check whether the lamp cover is installed securely.

7 Turn on the projector.

8 Bring up the menu and select [System settings] -> [Other settings] -> [Lamp counter]. (P109)

9 Select [Reset] -> [OK] to reset the lamp counter.

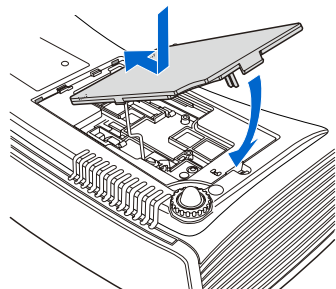



















Relationship between Aspect and Screen Aspect

This section describes the relationship between screen aspect (P62) and aspect (P65). To project an image on the whole screen, select the most appropriate screen aspect ratio and aspect according to the aspect ratio of the screen and input signal type.

When Projecting an Image from a Computer

When the input signal is [ANALOG PC-1], [ANALOG PC-2], or [DIGITAL PC (SX80 II)], select screen aspect and aspect as follows according to the resolution of the image on the computer.

Screen	Screen Aspect Ratio Setting	Resolution of Computer Screen	Object of Projection	Aspect Setting
4:3	[4:3]	SXGA+  4:3	 Project an image in a largest possible size on the screen.	[Auto] (or [4:3])
		VGA, SVGA, XGA  4:3	 Project an image in a largest possible size on the screen.	[4:3]
			 Project the computer screen in the original resolution.	[True size]
		WXGA 	 Project an image in a largest possible size on the screen.	[Auto]
			 Project the computer screen in the original resolution. (WUXGA not selectable)	[True size]
		SXGA  5:4	 Project an image in a largest possible size on the screen.	[Auto]
			 Project the computer screen in the original resolution.	[True size]
		16:9	[16:9]	SXGA+  4:3
VGA, SVGA, XGA  4:3	 Project an image in a largest possible size on the screen.			[Auto]
	 Project the computer screen in the original resolution.			[True size]
WXGA 	 Project an image in a largest possible size on the screen.			[Auto]
SXGA  5:4	 Project an image in a largest possible size on the screen.			[Auto]

When Projecting an Image from Image Software

To project an image such as an image shot by a TV set, commercially available DVD software, or video camcorder (input signal [HDMI (SX80 II)], [VIDEO], [S-VIDEO (SX80 II)], [COMPONENT]), select an aspect ratio according to the image software format as follows.

Screen	Screen Aspect Ratio Setting	Image Software Format	Projection Result	Aspect Setting
4:3	[4:3]	4:3		[Auto] ^{*1}
		16:9		
16:9	[16:9] [16:9 D. image shift] ^{*4}	4:3		[Auto] ^{*2}
		16:9		
	4:3		[Zoom] ^{*3}	

*1 [Auto] cannot be selected for the aspect setting if the input signal type is [VIDEO].

*2 If an image from image software with aspect ratio of 16:9 is not projected correctly, select [16:9] as screen aspect.

*3 If you project the 16:9 image with black borders at top and bottom such as in the terrestrial movie broadcasting, you can project the 16:9 image fully on the screen by selecting [Zoom] in [Aspect].

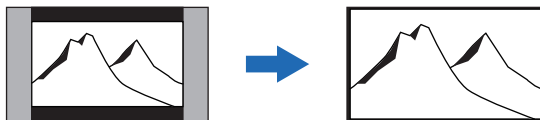



[Zoom] is available when [16:9] or [16:9 D. image shift] is selected for the screen aspect and [HDMI (480p)(SX80 II)], [COMPONENT (480p, 480i)], [VIDEO] or [S-VIDEO (SX80 II)] is selected for the input signal.

*4 To perform keystone adjustment (P60), select [4:3] or [16:9] for [Screen aspect].

When Projecting an Image from a Digital Camera or a USB Flash Memory (SX80 II)

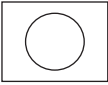
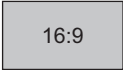
The [Auto] mode is automatically selected for the aspect ratio when displaying an image from a digital camera or USB flash memory (selecting [USB] as the input signal). The image is expanded fully on the screen with the screen aspect maintained.

Screen	Screen Aspect Ratio Setting	Projection Result	Aspect Setting
	[4:3]		[Auto]
	[16:9] [16:9 D. image shift]*		[Auto]

* To perform keystone adjustment (P60), select [16:9] for [Screen aspect].

Supported Computer Signal Types

This projector supports following signal types.

If your computer or AV equipment is compatible with any one of these signal types, the projector's auto PC function selects the input signal type to project an image appropriately.

ANALOG RGB

Resolution (dots)	Signal type	Horizontal frequency (KHz)	Vertical frequency (Hz)		
640 x 480	VGA	31.469	59.94		
		37.50	75.00		
		37.861	72.81		
		37.861	74.38		
		43.269	85.01		
720 x 400	-	31.469	70.09		
800 x 600	SVGA	34.50	55.38		
		35.156	56.25		
		37.879	60.32		
		37.898	61.03		
		38.00	60.51		
		38.60	60.31		
		46.875	75.00		
		48.077	72.19		
		53.674	85.06		
		1024 x 768	XGA	44.028	54.63
46.897	58.19				
47.00	58.31				
48.363	60.00				
48.496	60.02				
56.476	70.07				
58.032	72.00				
60.023	75.03				
60.314	74.92				
60.994	75.77				
62.04	77.07				
63.478	79.35				
68.677	85.00				
1280 x 768	WXGA			47.986	59.83
1280 x 800				49.702	60.03
1360 x 768	-	47.712	60.02		
1152 x 864	-	64.196	70.39		
1152 x 900	-	61.17	65.28		
		61.846	66.00		
		71.399	75.64		
1280 x 960	-	60.00	60.00		
1280 x 1024	SXGA	62.50	58.63		
		63.337	59.98		
		63.364	59.95		
		63.735	60.01		
		63.791	60.18		
		63.899	60.00		
		63.981	60.02		
		71.694	67.19		
		76.97	72.00		
		79.976	75.03		
		81.135	76.11		
1400 x 1050	SXGA+	63.981	60.02		
1600 x 1200	UXGA	75.00	60.00		
640 x 480	MAC LC 13	34.967	66.60		
640 x 480	MAC13	35.00	66.67		
832 x 624	MAC16	49.725	74.55		
1024 x 768	MAC19	60.248	75.03		
1152 x 870	MAC21	68.681	75.06		
1280 x 960	MAC	75.00	75.08		

* The specifications in the table above are subject to change without notice.

* This projector does not support any computer signal of which dot clock is 170 MHz or higher.

DVI (SX80 II)

Resolution (dots)	Signal type	Horizontal frequency (KHz)	Vertical frequency (Hz)
640 x 480	D-VGA	31.469	59.94
800 x 600	D-SVGA	37.879	60.32
1024 x 768	D-XGA	48.363	60.00
1280 x 1024	D-SXGA	63.981	60.02
1400 x 1050	D-SXGA+	63.981	60.02

HDMI (SX80 II)

Signal type	Horizontal frequency (KHz)	Vertical frequency (Hz)
480p	31.469	59.94
576p	31.250	50.00
720p	37.500	50.00
720p	44.955	59.94
1080i*	28.125	50.00
1080i*	33.716	59.94
1080p	56.250	50.00
1080p	67.433	59.94

* Interlaced signal

COMPONENT

Signal type	Horizontal frequency (KHz)	Vertical frequency (Hz)
480p	31.469	59.94
480i*	15.734	59.94
576p	31.250	50.00
576i*	15.625	50.00
720p	37.500	50.00
720p	44.955	59.94
1035i*	33.750	60.00
1080i*	28.125	50.00
1080i*	33.716	59.94
1080p	56.250	50.00
1080p	67.433	59.94

* Interlaced signal

Relationship between Screen Size and Projecting Distance

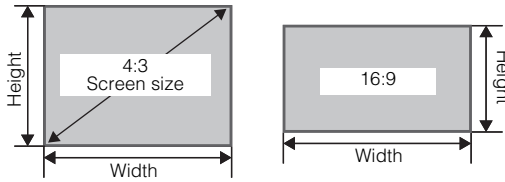

Screen size at 4:3 aspect ratio Type - W x D cm	Projecting distance m (feet) Max. zooming		Projecting distance m (feet) Min. zooming		Screen size at 16:9 aspect ratio W x D cm
	m	ft	m	ft	
40" (81 x 61)	1.2	(3.9')	1.7	(5.6')	81 x 46
50" (102 x 76)	1.5	(4.9')	2.2	(7.1')	102 x 57
60" (122 x 91)	1.8	(5.9')	2.6	(8.5')	122 x 69
70" (142 x 107)	2.1	(6.9')	3.1	(10.0')	142 x 80
80" (163 x 122)	2.4	(7.9')	3.5	(11.4')	163 x 91
90" (183 x 137)	2.7	(8.9')	4.0	(13.1')	183 x 103
100" (203 x 152)	3.0	(9.8')	4.4	(14.6')	203 x 114
110" (224 x 168)	3.3	(10.8')	4.9	(16.1')	224 x 126
120" (244 x 183)	3.6	(11.8')	5.3	(17.4')	244 x 137
130" (264 x 198)	3.9	(12.8')	5.8	(19.0')	264 x 149
140" (284 x 213)	4.2	(13.8')	6.2	(20.2')	284 x 160
150" (305 x 229)	4.5	(14.8')	6.6	(21.7')	305 x 171
160" (325 x 244)	4.8	(15.5')	7.1	(23.3')	325 x 183
170" (345 x 259)	5.1	(16.8')	7.5	(24.6')	345 x 194
180" (366 x 274)	5.4	(17.7')	8.0	(26.3')	366 x 206
190" (386 x 290)	5.7	(18.7')	8.4	(27.6')	386 x 217
200" (406 x 305)	6.0	(19.7')	8.9	(29.2')	406 x 229
210" (427 x 320)	6.4	(20.3')	-	-	427 x 240
220" (447 x 335)	6.7	(22.0')	-	-	447 x 251
230" (467 x 351)	7.0	(22.9')	-	-	467 x 263
240" (488 x 366)	7.3	(23.9')	-	-	488 x 274
250" (508 x 381)	7.6	(24.8')	-	-	508 x 286
260" (528 x 396)	7.9	(25.8')	-	-	528 x 297
270" (549 x 411)	8.2	(27.2')	-	-	549 x 309
280" (569 x 427)	8.5	(27.9')	-	-	569 x 320
290" (589 x 442)	8.8	(28.9')	-	-	589 x 331
300" (610 x 457)	9.1	(29.9')	-	-	610 x 343

* The values in the table above are approximations rounded off.

Glossary

* is only applicable to SX80 MarkII

sRGB (P67, P93)

An international standard of color representation (color space) which is applied to general digital cameras, displays and others. In this projector, if you select [sRGB] in the [Image mode] setting, the projector can project the best-quality image conforming to the sRGB Standard.

DVI* (P42, P54)

A digital video signal connection interface for a computer. This interface allows digital data to be transmitted without converting to analog data, assuring high image quality with no signal degradation. The DVI-I (integrated) connector can be used to transmit both an analog video signal and digital video signal.

Digital PC* (P29, P42)

A signal system used to send digital information of individual display dots. This system is free from deterioration of image quality because of no analog conversion. Connect the DVI output terminal on the computer and ANALOG PC-1/DVI-I IN terminal on this projector with an optional DVI digital cable (LV-CA29). Select [DIGITAL PC] at projection.

Analog PC (P29, P40, P80)

A signal system used to send analog signal information of R (red), G (green), and B (blue). Connect the analog RGB output terminal on your computer to ANALOG PC-1/DVI-I IN terminal or ANALOG PC-2/COMPONENT IN terminal on the projector (in SX800, ANALOG PC-1 IN terminal or ANALOG PC-2/COMPONENT IN terminal), and select [ANALOG PC-1] or [ANALOG PC-2] at the time of projection.

HDMI* (P44, P54)

An abbreviation for High-Definition Multimedia Interface, which is a digital video signal connection interface for AV equipment. It can transmit non-compressed images and audio signals simultaneously. It supports digital contents copy-protected with the HDCP technology. The projector supports HDMI 1.3 standard (10-bit deep color).

HDCP*

An abbreviation of High-bandwidth Digital Content Protection which is an encryption technology for copy protection of digital image signals. In this projector, you can project digital contents copy-protected with the HDCP technology.

VIDEO (P29, P45, P80)

An output terminal widely used in an AV equipment. It is also called as a composite output terminal (pin terminal or RCA terminal). For more details, refer to "Composite".

Composite (P29, P45)

A video signal system used to send a brightness signal (Y) and a color signal (C) together. Connect the composite output (RCA) terminal on the AV equipment and the VIDEO IN terminal on this projector with a video cable. Select [VIDEO] at projection.

S-VIDEO* (P29, P45, P80)

A signal system (YC separation signal) used to send a brightness signal (Y) and color signal (C) separately. Connect the S-video terminal on the AV equipment and the S-VIDEO IN terminal on this projector with an S-video cable. Select [S-VIDEO] at projection.

Aspect (P65, P79, P147)

The aspect ratio is the ratio of the horizontal dimension (width) to the vertical dimension (height) of a screen. It is expressed as "width : height."

The following aspect ratios are normally used in Computer or AV equipment.

[4:3]

The aspect ratio for SXGA+ (1400 x 1050) and XGA (1024 x 768) display resolution in PC or for the traditional television screen.

The aspect ratio for this projector is 4:3.

[5:4]

The aspect ratio for SXGA (1280 x 1024) display resolution.

[16:9]

The aspect ratio for the high resolution digital television or digital terrestrial broadcasting.

For the aspect ratio for movie screens, "vista vision size" and "cinema scope size", etc. are used.

"Vista vision size"

The aspect ratio close to 16:9. Select [Auto] or [16:9] for [Aspect]. The back belts are added at the top and bottom of the image.

"Cinema scope size"

The landscape-oriented aspect ratio of 8:3. Select [Auto] or [16:9] for [Aspect]. The back belts are added at the top and bottom of the image.

Component (P29, P46, P98)

A signal system in which an image is transmitted by being broken down the brightness signal (Y) and the color signal (C) into the B-Y color difference signal and the R-Y color difference signal. Its image quality is higher than that of the composite video. This system can project a better-quality image as compared with the composite signal system. Connect the component video terminal on the AV equipment and the ANALOG PC-2/COMPONENT IN terminal on this projector with a component cable. Select [COMPONENT] at projection.

Tracking (P57, P82)

To reproduce an image from an analog image signal, the process to accumulate image information at the appropriate timing with reference to the synchronization signal within the image signal is required. This process is called the tracking. This projector can display an image properly by automatically adjust the tracking with the auto PC adjustment function even if there is a small difference in the synchronization signal from an analog imaging device.

Resolution (P56)

The number of dots (horizontal dots x vertical dots) that can be displayed on the screen. It describes the fineness (information amount) of the displayed image.

Resolution	Number of dots	
	Horizontal	Vertical
VGA	640	480
SVGA	800	600
XGA	1024	768
SXGA	1280	1024
SXGA+	1400	1050
UXGA	1600	1200

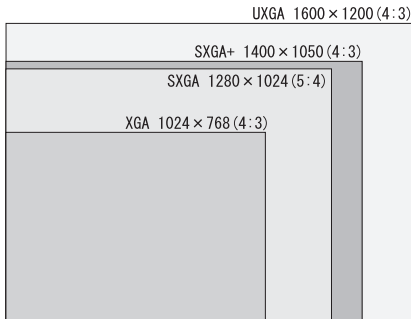

Number of dots in each resolution

If you select SXGA+ (1400 dots x 1050 dots) as the display resolution for the connecting computer, this projector can project high-resolution images. If your computer does not have the SXGA+ option, select the maximum resolution among the selectable options.

Progressive (P85)

An image display system used to display the entire screen per scan. For an interlace signal (video signal) that displays one screen by two scans (one for odd lines and one for even lines) is input, progressive processing is required. When the progressive function is turned off, one screen is displayed using image signals per interlace signal, deteriorating the vertical resolution of the image. When the progressive function is turned on, one screen is displayed using image signals per two interlace signals, improving the vertical resolution of the image. Turn off the progressive function when flickering and horizontal lines are noticeable on a fast-moving picture.

Offset (P97)

A parameter that shifts the reproduction range of a brightness signal from black to white within an image signal toward the higher or lower level of brightness. The reproducibility of the dark tone is mainly changed. Since you can adjust the offset for each RGB color in this projector, you can also adjust colors.

The offset is normally adjusted with the gain.

Color temperature* (P96)

A value that represents the related color in a light source in general. In this projector, the color temperature is used to adjust the RGB color balance for the projected image to correct the related color influence by the ambient light. If you increase and decrease the color temperature, white changes to blue and red, respectively. You can set the color temperature in the [Color adjustment] menu if [Photo] has been selected for [Image mode].

Ambient light* (P101)

Lighting environment around the projector. You can correct and project an image more appropriately according to the ambient light on the screen via the setting of [Ambient light] if you have selected [Photo] for [Image mode].

Gamma Correction (P95, P99)

A tone adjustment system used during projection of image data. The gamma correction function works effectively when portions of an image are obscure because they are too light or dark.

This projector supports manual gamma correction and dynamic gamma correction which performs the gamma correction automatically.

Gain (P97)

A parameter that adjusts the reproduction range of a brightness signal from black to white within the image signal to naturally reproduce it on the screen. The reproducibility of the bright tone is mainly changed. Since you can adjust the gain for each RGB color in this projector, you can also adjust colors. The gain is normally adjusted with the offset.

Memorized Color Correction * (P99)

A memorized color is a color in our memory. The memorized color such as blue for the sky is more vivid than the real color, so you may feel colors of a projected image are dull. If such is the case, enable the memorized color correction function to make the colors close to the ones in our memory. You can enable the memorized color correction function in the image adjustment menu.

6-axis color adjust* (P100)

The color adjustment function for an advanced user. You can adjust color balance and color level for 6 axis of RGB (red/green/blue) and CMY (cyan/magenta/yellow) of the projected image to make a fine color adjustment. You can perform the 6-axis color adjustment in the image adjustment menu.

PictBridge* (P114)

A standard protocol established by CIPA (Camera & Imaging Products Association) that supports various digital photo solutions including camera direct print to print shot images by directly connecting a digital camera to a printer without via a computer. Other than digital cameras, some digital video camcorders and mobile phones are compatible with PictBridge. In this projector, you can project shot images by directly connecting PictBridge-compatible equipment.

DPOF* (P115)

An abbreviation of Digital Print Order Format. It is a protocol to record information specified for printing such as images to be printed and the number of copies on a memory card for PictBridge-compatible digital camera. In this projector, use this function to continuously project multiple shot images from a connected digital camera.

Specifications

■ Projector

Model name		SX80 MarkII/SX800
Display system		RGB liquid crystal system
Optical system		Color separation by dichroic mirror/polarizing beam splitter and color composition by prism
Display device	Type	Reflective liquid crystal panel
	Size/Aspect ratio	0.55" x 3/4:3
	Drive system	Active matrix system
Projection lens	Number of pixels/Total Number of pixels	1,470,000 (1400 x 1050) x 3 panels/4,410,000
	Zoom ratio/Focal length/F value	1.5f=16.6 to 24.8mm/F1.95 to F2.6
	Zooming and focusing system	Electronic operation/electronic operation (SX80 MarkII: with auto focusing function)
Lens shift		10:0 (fixed)
Light source		230W high-pressure lamp
Screen size (projection distance)		40" to 300" (1.2m/3.9' to 9.1m/12.8')
Number of producible colors		16,770,000 colors (full color)
Brightness*		3,000 lm (at presentation)
Contrast ratio		900:1 (full white:full black, at presentation)
Uniformity*		88% (at presentation)
Speaker		1W monaural x 1
Maximum input resolution		1600 x 1200 dots (compression)
Video signals	ANALOG PC input	UXGA/SXGA+/SXGA/WXGA/XGA/SVGA/VGA (scan rate: horizontal: 15 to 75KHz, vertical 50 to 85Hz)
	DIGITAL PC input (SX80 II)	SXGA+/SXGA/XGA/SVGA/VGA
	COMPONENT input	1080p, 1080i, 1035i, 720p, 576p, 576i, 480p, 480i
	HDMI input (SX80 II)	1080p, 1080i, 720p, 576p, 480p
	VIDEO/S-VIDEO (SX80 II) input	NTSC, PAL, SECAM, NTSC4.43, PAL-M, PAL-N
Input terminals	ANALOG PC-1/DVI-I IN terminal (SX80 II)	DIGITAL PC, ANALOG PC-1 (DVI-I connector 29-pin)
	HDMI IN terminal (SX80 II)	HDMI (HDMI ver. 1.3)
	ANALOG PC-1 terminal (SX800)	ANALOG PC-1 (mini D-sub 15-pin)
	ANALOG PC-2/COMPONENT IN terminal	ANALOG PC-2, COMPONENT (mini D-sub 15-pin)
	S-VIDEO IN terminal (SX80 II)	S-Video (mini DIN 4-pin)
	VIDEO IN terminal	Composite (RCA)
	USB terminal (SX80 II)	USB connection, PictBridge input (USB type A)
	CONTROL terminal	RS-232C (D-sub 9-pin)
Audio Input terminal		Audio signal (stereo mini jack x 3)
Video Output terminal (SX80 II)		Analog PC (mini D-sub 15-pin)
Audio Output terminal		Audio signal (stereo mini jack)
LAN terminal (SX80 II)		Network connection (RJ-45)
Input signals	Digital PC (SX80 II)	TMDS (Transition Minimized Differential Signaling)
	Analog PC	0.7Vp-p, positive polarity, impedance = 75Ω Horizontal/vertical synchronization: TTL level, negative or positive polarity Composite synchronization in G signal: 0.3Vp-p, negative polarity, impedance=75Ω
	Video	Video: 1Vp-p, negative synchronization, impedance = 75Ω S-video: Separate YC signal, Y: 1Vp-p, negative synchronization, impedance = 75Ω C: 0.286Vp-p (burst signal), impedance = 75Ω Component: Separate Y Cb/Pb Cr/Pr signal Y: 1Vp-p, Negative synchronization, impedance = 75Ω Cb/Pb: 0.7Vp-p, impedance = 75Ω Cr/Pr: 0.7Vp-p, impedance = 75Ω
	Audio	142mVrms, impedance = 47 KΩ or more
Noise (normal mode/silent mode)		35/31dB
Operating temperature		5 °C to 35 °C
Power supply		AC 100-240 V 50/60 Hz
Power consumption (normal mode/silent mode/standby state)		330W/270W/15W (SX80 II) 320W/260W/8W (SX800)
Dimensions		332 (W) x 121 (H) x 340 (D) mm/13.3 (W) x 4.8 (H) x 13.6 (D) in (excluding protrusions)
Weight		5.2 kg/11.4 lbs (SX80 II) 5.0 kg/11.0 lbs (SX800)
Accessories		Remote control, batteries for remote control, power cord, computer connection cable, component cable, carrying bag, lens cover, string for lens cover, User's Manual, and Warranty Card.

* 99.99% or more of the LCD panel pixels are effective. During projection, 0.01% or less of pixels may stay lit or unlit due to the characteristics of the LCD panel.

* Using the projector continuously for an extended period of time may accelerate the deterioration of optical parts.

■ Remote Control

Power supply	Two 3.0 V, AAA-size batteries
Operating range	About 5 m (16.4') (to infrared remote receiver)
Dimensions	42 (W) x 22 (H) x 135 (D) mm / 1.7 (W) x 0.9 (H) x 5.3 (D) in
Weight (not including batteries)	55 g

External View

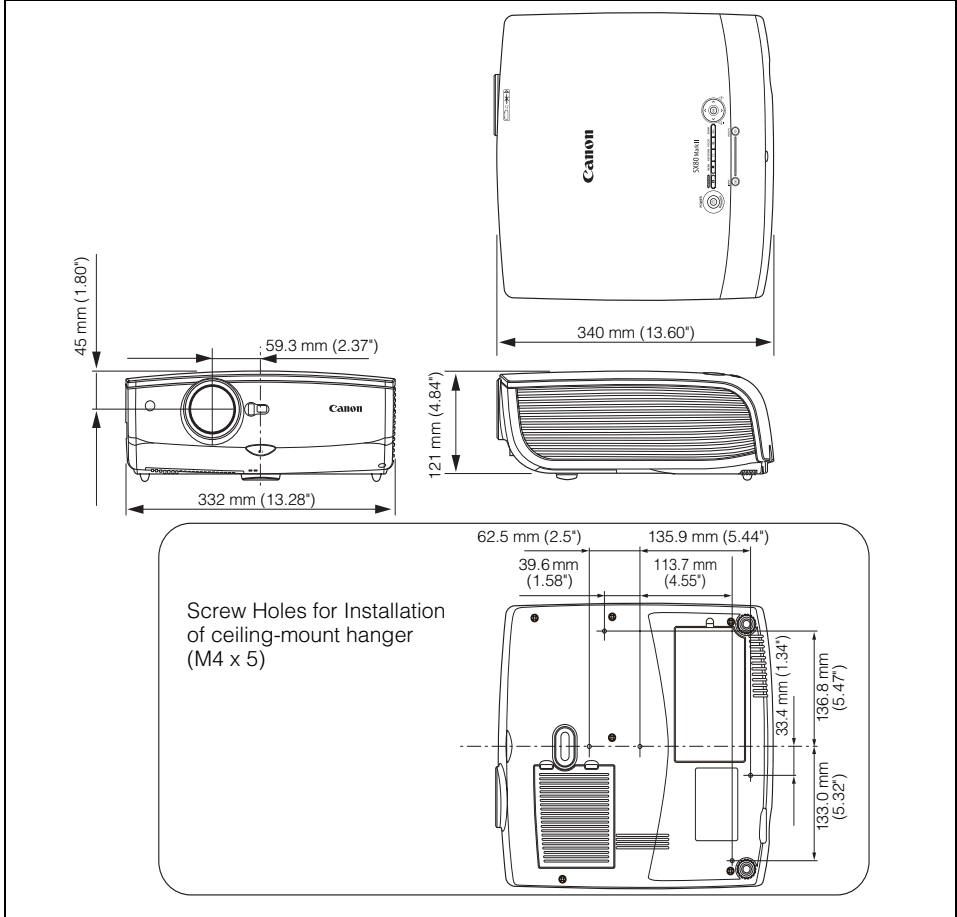

ANALOG PC-1 (SX800), ANALOG PC-2/COMPONENT IN terminal

This terminal is used as a computer analog PC input or component input terminal. Use a D-sub computer cable for connection.

The terminal specifications for the analog PC input and component input are the same.

Mini D-sub 15-pin

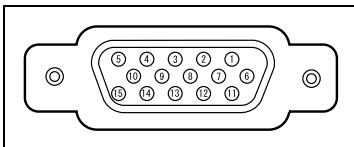

1	R	9	+5 V power
2	G	10	Ground (Vertical sync.)
3	B	11	Monitor ID0
4	Monitor ID2	12	DDC data
5	Ground (Horizontal sync.)	13	Horizontal sync.
6	Ground (R)	14	Vertical sync.
7	Ground (G)	15	DDC clock
8	Ground (B)		

■ Service Port (CONTROL)

D-sub 9pin

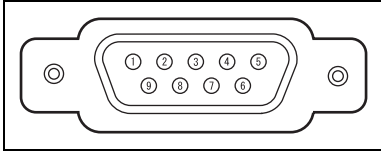

Pin No.	Signal
1	OPEN
2	RxD
3	TxD
4	OPEN
5	GND
6	OPEN
7	OPEN
8	OPEN
9	OPEN

Communication format

Communication mode: RS-232-C, asynchronous,
half-duplex communication

Communication speed: 19,200 bps

Character length: 8 bits

Stop bits: 2 bits

Parity: None

Flow control: None

Control Commands

Function		ASCII Representation	Binary Representation
Power supply	On	POWER ON<CR>	50h 4Fh 57h 45h 52h 20h 4Fh 4Eh 0Dh
	Off	POWER OFF<CR>	50h 4Fh 57h 45h 52h 20h 4Fh 46h 46h 0Dh
	Get	GET POWER<CR>	47h 45h 54h 20h 50h 4Fh 57h 45h 52h 0Dh
Input signals	Digital PC (SX80 II)	INPUT=D-RGB<CR>	49h 4Eh 50h 55h 54h 3Dh 44h 2Dh 52h 47h 42h 0Dh
	HDMI (SX80 II)	INPUT=HDMI<CR>	49h 4Eh 50h 55h 54h 3Dh 48h 44h 4Dh 49h 0Dh
	Analog PC-1	INPUT=A-RGB1<CR>	49h 4Eh 50h 55h 54h 3Dh 41h 2Dh 52h 47h 42h 31h 0Dh
	Analog PC-2	INPUT=A-RGB2<CR>	49h 4Eh 50h 55h 54h 3Dh 41h 2Dh 52h 47h 42h 32h 0Dh
	Component	INPUT=COMP<CR>	49h 4Eh 50h 55h 54h 3Dh 43h 4Fh 4Dh 50h 0Dh
	Video	INPUT=VIDEO<CR>	49h 4Eh 50h 55h 54h 3Dh 56h 49h 44h 45h 4Fh 0Dh
	S-Video (SX80 II)	INPUT=S-VIDEO<CR>	49h 4Eh 50h 55h 54h 3Dh 53h 2Dh 56h 49h 44h 45h 4Fh 0Dh
	USB (SX80 II)	INPUT=USB<CR>	49h 4Eh 50h 55h 54h 3Dh 55h 53h 42h 0Dh
	Get	GET INPUT<CR>	47h 45h 54h 20h 49h 4Eh 50h 55h 54h 0Dh
Image mode	Standard	IMAGE=STANDARD<CR>	49h 4Dh 41h 47h 45h 3Dh 53h 54h 41h 4Eh 44h 41h 52h 44h 0Dh
	Presentation	IMAGE=PRESENTATION<CR>	49h 4Dh 41h 47h 45h 3Dh 50h 52h 45h 53h 45h 4Eh 54h 41h 54h 49h 4Fh 4Eh 0Dh
	Movie	IMAGE=MOVIE<CR>	49h 4Dh 41h 47h 45h 3Dh 4Dh 4Fh 56h 49h 45h 0Dh
	sRGB	IMAGE=SRGB<CR>	49h 4Dh 41h 47h 45h 3Dh 53h 52h 47h 42h 0Dh
	Photo	IMAGE=PHOTO<CR>	49h 4Dh 41h 47h 45h 3Dh 50h 48h 4Fh 54h 4Fh 0Dh
		Get	GET IMAGE<CR>
Brightness	Setting	BRI=<value><CR>	42h 52h 49h 3Dh <numeric code> 0Dh
		GET BRI<CR>	47h 45h 54h 20h 42h 52h 49h 0Dh
Sharpness	Setting	SHARP=<value><CR>	53h 48h 41h 52h 50h 3Dh <numeric code> 0Dh
		GET SHARP<CR>	47h 45h 54h 20h 53h 48h 41h 52h 50h 0Dh
Contrast	Setting	CONT=<value><CR>	43h 4Fh 4Eh 54h 3Dh <numeric code> 0Dh
		GET CONT<CR>	47h 45h 54h 20h 43h 4Fh 4Eh 54h 0Dh
Aspect ratio	Auto	ASPECT=AUTO<CR>	41h 53h 50h 45h 43h 54h 3Dh 41h 55h 54h 4Fh 0Dh
	4:3	ASPECT=4:3<CR>	41h 53h 50h 45h 43h 54h 3Dh 34h 3Ah 33h 0Dh
	16:9	ASPECT=16:9<CR>	41h 53h 50h 45h 43h 54h 3Dh 31h 36h 3Ah 39h 0Dh
	Zoom	ASPECT=ZOOM<CR>	41h 53h 50h 45h 43h 54h 3Dh 5Ah 4Fh 4Fh 4Dh 0Dh
	True size	ASPECT=TRUE<CR>	41h 53h 50h 45h 43h 54h 3Dh 54h 52h 55h 45h 0Dh
		GET ASPECT<CR>	47h 45h 54h 20h 41h 53h 50h 45h 43h 54h 0Dh

Function		ASCII Representation	Binary Representation
Lamp mode	Normal	LAMP=NORMAL<CR>	4Ch 41h 4Dh 50h 3Dh 4Eh 4Fh 52h 4Dh 41h 4Ch 0Dh
	Quiet	LAMP=SILENT<CR>	4Ch 41h 4Dh 50h 3Dh 53h 49h 4Ch 45h 4Eh 54h 0Dh
	Get	GET LAMP<CR>	47h 45h 54h 20h 4Ch 41h 4Dh 50h 0Dh
BLANK	Blank On	BLANK=ON<CR>	42h 4Ch 41h 4Eh 4Bh 3Dh 4Fh 4Eh 0Dh
	Blank Off	BLANK=OFF<CR> 42h	42h 4Ch 41h 4Eh 4Bh 3Dh 4Fh 46h 46h 0Dh
	Get	GET BLANK<CR>	47h 45h 54h 20h 42h 4Ch 41h 4Eh 4Bh 0Dh

Index

Numerics

6-axis color adjust (SX80 II) 100, 155

A

Adjustable foot 37

Adjusting keystone distortion 60

Adjusting the focus 59

Adjusting the volume 71

Air filter 144

Ambient light (SX80 II) 101

ANALOG PC 40, 54

Analog PC 152

ANALOG PC-1 Input Terminal
(SX800) 29, 40, 54

ANALOG PC-1/DVI-I
IN terminal (SX80 II) 29, 40, 42, 54

ANALOG PC-2/COMPONENT
IN terminal 29, 41, 46, 54

ASPECT 66

Aspect 62, 65, 79, 147, 153

Audio IN terminal 30, 40, 41, 42, 45, 46

Audio OUT terminal 30, 43, 47

Authentication and Encryption
Protocols (SX80 II) 133

Auto (Aspect) 65

Auto fleshtone (SX800) 100

Auto focus (SX80 II) 52, 103

Auto input 52, 103

Auto keystone 52, 103

AUTO PC 57

Auto screen color (SX80 II) 52, 103

AUTO SET 53

Auto setup 52, 103

B

Beep 104

BLANK 70

Brightness 94

C

Carrying bag 19, 23

Ceiling mounted 36, 87

Channel setting 107

Color adjustment 97

Color temperature (SX80 II) 96

COMPONENT 46, 54, 81

Component 153

Composite 152

Connecting the projector to the
computer 40

Contrast 94

D

D. ZOOM 72

D.SHIFT/KEystone 60, 64

Digital camera (SX80 II) 114

DIGITAL PC (SX80 II) 42, 54

Digital PC (SX80 II) 152

Direct power on 104

Display resolution
(preparing the computer) 56

Display settings menu 76

Displays logo 90, 91

DPOF (SX80 II) 115, 155

DVI (SX80 II) 42, 54, 152

DVI-I IN (SX80 II) 40, 42, 54

Dynamic gamma 99

E

External monitor (SX80 II) 42

F

Factory defaults 111

FOCUS 59

FREEZE 70

G

Gain 96, 97, 155

Gamma correction 95, 154

Guide 106

H

HDCP 152

HDMI (SX80 II) 44, 54, 152

HDMI IN terminal (SX80 II) 29, 44

HDMI input level (SX80 II) 84

- HDMI over scan (SX80 II) 85
- Horizontal pixels 83
- Horizontal position 82
- I**
- IMAGE 67
- Image adjustment menu 76
- Image flip H/V 87
- Image mode 93
- Image mode (Image quality) 67
- Information 76, 112
- INPUT 55
- Input signal select 80, 81
- Input terminal 29
 - Connecting the projector
 - to the computer 40
 - Connecting to AV equipment 44
- Installation 19
- IP address (SX80 II) 126
- K**
- Key lock 105
- Keystone 60
- L**
- LAMP 102
- Lamp counter 109
- Lamp mode 102
- Lamp replacement 109, 145, 146
- LAN port (SX80 II) 30, 126
- Language 105
- LED illumination 106
- Lens cap 22
- Logo capture (SX800) 88
- Logo position (SX800) 88
- M**
- Mem. color correct (SX80 II) 99
- Memorized color correction
 - (SX80 II) 155
- MENU 76
- Menu display time 108
- Menu position 86
- Monitor output terminal
 - (SX80 II) 29, 42
- MUTE 71
- N**
- Network settings (SX80 II) 111, 126
- Noise reduction 98
- O**
- Offset 96, 97, 154
- OK 27
- P**
- Password settings 108
- PictBridge (SX80 II) 114, 155
- POWER 49, 68, 104
- Power management 50
- Power management mode
 - (settings) 103
- Power saving (power management) 50
- Progressive 85, 154
- Projecting distance 35, 151
- Projector on 90, 91
- P-TIMER 73
- R**
- Rear projection 36, 87
- Register password 109
- Remote control 26, 31, 107
- Reset 102, 111
- Resolution 65, 153
- Reverse projection
 - (ceiling-mounted/rear projection) 87
- S**
- Screen aspect 62, 92, 147
- Screen color 86
- Screen size 151
- Screen when blank 89, 91
- Selecting a language 50, 105
- Selecting an input signal 54
- Setting Display Status 79
- Setting the Image Quality 93

Setting up the projector	19, 35
Setting Various Function	103
Sharpness	95
Signal type	150
Slideshow (SX80 II)	107, 117, 124
SNMP Agent Function (SX80 II)	132
sRGB	67, 93, 152
S-VIDEO (SX80 II)	45, 54, 152
S-VIDEO input terminal (SX80 II)	29, 45
System settings menu	76
T	
Top control	28
Total dots	81
Tracking	82, 153
True size (Aspect)	65
Turning on external monitor output (preparing the notebook computer)	51
U	
USB (SX80 II)	54, 118
USB terminal (SX80 II)	29, 48, 114, 118
V	
Vertical pixels	84
Vertical position	83
VIDEO	45, 54, 152
VIDEO IN terminal	29, 45
VOL	71
W	
WARNING lamp	28, 138
Z	
ZOOM	58
Zoom (Aspect)	65
Zoom (image size)	58
Zooming an Image	72

Options

- Replacement lamp
Part No.: RS-LP05
- Ceiling-mount hanger
Part No.: RS-CL10
- Ceiling-mount pipe
(40 cm/16 in to 60 cm/24 in)
Part No.: RS-CL08*
- Ceiling-mount pipe
(60 cm/24 in to 100 cm/40 in)
Part No.: RS-CL09*
- DVI digital cable
Part No.: LV-CA29

* This part is used to hang the projector from a ceiling.
For more detailed information, refer to the instruction manual that comes with the ceiling-mount hanger RS-CL10.

Menu Configuration

The Display settings menu

Aspect	DIGITAL PC (SX80 II)/ ANALOG PC	P79	Input signal settings	ANALOG PC		
	Auto *			Total dots	P81	
	4:3			Tracking	P82	
	16:9			Horizontal position	P82	
	True size			Vertical position	P83	
	VIDEO			Horizontal pixels	P83	
	4:3 *			Vertical pixels	P84	
	16:9			HDMI input level (SX80 II)	HDMI	P84
	Zoom			Auto *		
	S-VIDEO (SX80 II)			Normal		
	Auto *			Expanded		
	4:3			HDMI over scan (SX80 II)	HDMI	P85
	16:9			Off		
	Zoom			On *		
	HDMI (SX80 II)			Progressive	VIDEO/S-VIDEO (SX80 II)/ COMPONENT/HDMI (SX80 II)	P85
	Auto *				Off	
	4:3				On	
	16:9				Auto *	
	Zoom			Menu position	P86	
	True size			Screen color	Normal *	P86
	COMPONENT				Greenboard	
	Auto *				Adjust Red/Green/Blue	
	4:3			Image flip H/V	None *	P87
16:9				Ceiling mounted		
Zoom				Rear		
True size				Rear, Ceiling mounted		
USB (SX80 II)			User screen settings			
Auto			Logo capture (SX800)	OK/Cancel	P88	
ANALOG PC	P80		Logo position (SX800)	Upper L	P88	
640 x 480				Upper R		
:				Center *		
1400 x 1050				Lower L		
VIDEO/S-VIDEO (SX80 II)	P80		No signal screen	Lower R		
Auto *				Black	P89	
NTSC				Blue *		
PAL				User logo (SX800)		
SECAM			Screen when blank	Black *	P89	
NTSC4.43				Blue		
PAL-M				User logo (SX800)		
PAL-N			Projector on	Skip	P90	
COMPONENT	P81			Canon logo *		
Auto *			Return	User logo (SX800)		
1080p						
1080i			Screen aspect	4:3 *	P92	
1035i				16:9		
720p				16:9 D. image shift		
576p						
480p						
576i						
480i						
Input signal select						

The Image adjustment menu

Image mode	COMMON P93
	Standard *
	Presentation
	Movie
	sRGB
	DIGITAL PC/ANALOG PC/USB P93
	Photo (SX80 II)

Brightness	P94
Contrast	P94
Sharpness	P95
Gamma	P95

Color adjustment	DIGITAL PC (SX80 II)/ANALOG PC (SX80 II)/USB (SX80 II) P96
	Color level **
	Color temperature **
	VIDEO/S-VIDEO (SX80 II)/COMPONENT P97, P98
	Color level
	Color balance (only for COMPONENT)
	COMMON P96
	R Gain
	R Offset
	G Gain
	G Offset
	B Gain
	B Offset

Advanced adjustment	Noise reduction VIDEO/S-VIDEO (SX80 II)/COMPONENT/HDMI (SX80 II) P98
	Off
	Weak
	Strong
	Dynamic gamma P99
	Off
	Weak
	Strong
	Mem. color correct (SX80 II) P99
	Off
	L
	M
	H
	Auto fleshtone (SX800) P100
	Off
	L
	M
	H
	6-axis color adjust (SX80 II) P100
	Off *
	Adjust Hue/Saturation
	Reset
	Return

DIGITAL PC/ANALOG PC/USB P101	Ambient light (SX80 II) **
	Off
	Adjust
	Type
	Tungsten
	Fluorescent
	Fluorescent H
	Level
	L
	M
	H
Lamp mode	Normal * P102
	Quiet
Reset	OK/Cancel P102

* : Factory defaults (setting after reset)

** : You can set this if you have selected [Photo] for [Image mode].

[DIGITAL PC], [HDMI], [USB], and [S-VIDEO] are supported only in SX80 MarkII.

The System settings menu

Auto setup	P103	
Auto focus (SX80 II)	Off	On *
Auto keystone	Off	On *
Auto input	Off	On *
Auto screen color (SX80 II)	Off *	On
Return		
Power management mode	Off *	Standby Exit
Direct power on	Off *	On
Beep	Off	On *
Key lock	Off *	Main unit Remote control
Language	English	Polish
	Germany	Hungarian
	French	Czech
	Italian	Danish
	Spanish	Arabic
	Portuguese	Chinese
	Swedish	(Simplified)
	Russian	Chinese
	Dutch	(Traditional)
	Finnish	Korean
	Norwegian	Japanese
	Turkish	
Guide	Off	On *
LED illumination	Off	On *
Slideshow interval (SX80 II)	--:--	

Other settings		
Remote control	Ch1 *	Ch2
Menu display time	Normal *	Extended
Password settings	Off *	On
Register password	Password input	
Lamp counter	Return	Reset (OK/Cancel)
Network setting Initialization (SX80 II)	YES/NO	
Factory defaults	OK/Cancel	
Return		

The Information menu

Model name	
Input signal	
Firmware	
Serial no.	
IP address (SX80 II)	
Gateway address (SX80 II)	
E-mail sender address (SX80 II)	
E-mail recipient address (SX80 II)	
Projector name (SX80 II)	
System information ID	

*: Factory defaults (setting after reset)

[DIGITAL PC], [HDMI], [USB], and [S-VIDEO] are supported only in SX80 MarkII.



**CANON INC.**

30-2, Shimomaruko 3-chome, Ohta-ku, Tokyo
146-8501, Japan

U.S.A.

CANON U.S.A. INC.

One Canon Plaza, Lake Success, NY 11042-
1198, U.S.A.

For all inquiries concerning this product, call toll
free in the U.S.

1-800-OK-CANON

CANADA

CANON CANADA INC. HEADQUARTERS

6390 Dixie Road, Mississauga, Ontario L5T
1P7, Canada

CANON CANADA INC. MONTREAL BRANCH

5990, Côte-de-Liesse, Montréal Québec H4T
1V7, Canada

CANON CANADA INC. CALGARY OFFICE

2828, 16th Street, N.E. Calgary, Alberta T2E
7K7, Canada

For all inquiries concerning this product, call toll
free in Canada

1-800-OK-CANON

EUROPE, AFRICA & MIDDLE EAST

CANON EUROPE LTD.

3 The Square Stockley Park Uxbridge UB11
1ET United Kingdom

CANON EUROPA N.V.

Bovenkerkerweg 59-61, 1185 XB Amstelveen,
The Netherlands

CANON FRANCE S.A.S

17, quai du President Paul Doumer, 92414
Courbevoie Cedex, France

CANON UK LTD.

Woodhatch Reigate Surrey RH2 8BF, United
Kingdom

CANON DEUTSCHLAND GmbH

Europark Fichtenhain A10, 47807 Krefeld, Ger-
many

CANON ITALIA S.p.A.

Via Milano 8 I-20097 San Donato Milanese, Mil-
ano, Italy

CANON Schweiz AG

Geschäftsbereich Wiederverkauf, Industri-
estrasse 12, CH-8305 Dietlikon,
Switzerland

CANON GMBH

Zetschegasse 11, A-1230 Wien, Austria

CANON España, S.A.

C/Joaquin Costa, 41, 28002 Madrid, Spain

CANON PORTUGAL S.A.

Rua Alfredo da Silva, 14 Alfragide 2610-016
Amadora, Portugal

CANON Belgium N.V./S.A.

Berkenlaan 3, 1831 Diegem (Mechelen), Bel-
gium

CANON Netherland NV

Neptunusstraat 1, 2132 JA Hoofddorp, The
Netherlands

CANON LUXEMBOURG S.A.

Rue des Joncs 21, L-1818 Howald, Luxem-
bourg

CANON DANMARK A/S

Knud Hoejgaards Vej 1 DK-2860 Soeborg, Dan-
mark

CANON OY

Huopalahdentie 24 PL 1 00351 Helsinki, Fin-
land

CANON SVENSKA AB

Gustav III:s Boulevard 26 169 88 Solna, Swe-
den

CANON NORGE as

Hallagerbakken 110, Postboks 33, Holmlia,
1201 Oslo, Norway

CENTRAL & SOUTH AMERICA

CANON LATIN AMERICA, INC.

703 Waterford Way, Ste. 400 Miami, FL 33126,
U.S.A.

ASIA

CANON (China) Co., Ltd.

15F Jinbao Building No.89 Jinbao Street,
Dongcheng District, Beijing 100005, China

CANON HONGKONG CO., LTD.

19/F., The Metropolis Tower, 10 Metropolis
Drive, Hunghom, Kowloon, Hong Kong

CANON SINGAPORE PTE. LTD.

1 HarbourFront Avenue, #04-01 Keppel Bay
Tower, Singapore 098632

CANON KOREA CONSUMER IMAGING INC.

Gangnam Finance Center 17F,737, Yeoksam-
Dong, Gangnam-gu, Seoul, 135-984, Korea

OCEANIA

CANON AUSTRALIA PTY. LTD.

1 Thomas Holt Drive, North Ryde, N.S.W. 2113,
Australia

CANON NEW ZEALAND LTD.

Akoranga Business Park, Akoranga Drive,
Northcote, Auckland, New Zealand