



**INSTRUCTION MANUAL  
FOR  
MODEL KH-260**

## CONTENTS

<b>ORIGINAL PATTERNS</b> .....	1
<b>HOW TO USE THE KNITTING MACHINE</b>	
1. <b>SETTING UP THE KNITTING MACHINE</b> .....	7
2. <b>PARTS NAME</b> .....	9
3. <b>BEFORE STARTING TO KNIT</b> .....	12
(1) <b>NEEDLE POSITION</b> .....	12
(2) <b>ROW COUNTER</b> .....	12
(3) <b>TENSION DIAL</b> .....	12
(4) <b>CAST-ON COMB</b> .....	12
(5) <b>CAM BUTTON</b> .....	13
(6) <b>CHANGE KNOB</b> .....	13
4. <b>BASIC OPERATION</b> .....	14
5. <b>PATTERN KNITTING</b> .....	18
<b>PUNCH CARD</b> .....	19
<b>BASIC STEPS</b> .....	20
<b>TUCK STITCH PATTERN</b> .....	22
<b>TWO COLOUR TUCK STITCH PATTERN</b> .....	24
<b>SKIP STITCH PATTERN</b> .....	25
<b>TWO COLOUR SKIP STITCH PATTERN</b> .....	26
<b>WEAVING PATTERN</b> .....	27
<b>WEAVING MOTIF PATTERN</b> .....	29
<b>FAIRISLE PATTERN</b> .....	31
<b>DOUBLE LENGTH PATTERN</b> .....	33
<b>FAIRISLE MOTIF PATTERN</b> .....	35
<b>THREAD LACE PATTERN</b> .....	39
<b>THREAD LACE MOTIF PATTERN</b> .....	40
<b>PLATING YARN KNITTING</b> .....	41
<b>TUCK STITCH PLATING YARN KNITTING</b> .....	42
6. <b>REPLACING THE KNITTING MACHINE</b> .....	43
<b>USING THE KNITLEADER</b> .....	45
<b>MAKING GARMENTS</b>	
(1) <b>HOW TO USE THE TRANSFER TOOL</b> .....	48
(2) <b>HOW TO USE THE LATCHET TOOL</b> .....	48
(3) <b>HOW TO INCREASE THE STITCHES</b> .....	49
(4) <b>HOW TO DECREASE THE STITCHES</b> .....	51
(5) <b>PARTIAL KNITTING</b> .....	53
(6) <b>CABLE STITCH PATTERN</b> .....	56
(7) <b>RIBBING STITCHES</b> .....	56
(8) <b>TUBE KNITTING</b> .....	57
<b>USEFUL HINTS</b>	
<b>IF THE CARRIAGE SHOULD JAM</b> .....	58
<b>REPLACING A NEEDLE</b> .....	61
<b>PICKING UP DROPPED STITCHES</b> .....	63
<b>IF THE GATE PEGS CATCH THE YARN</b> .....	63
<b>MAINTENANCE</b> .....	65

# ORIGINAL PATTERNS

## TUCK STITCH PATTERN (No. 1p, 2p, 3p, 4p, 5p, 7p, 8p)

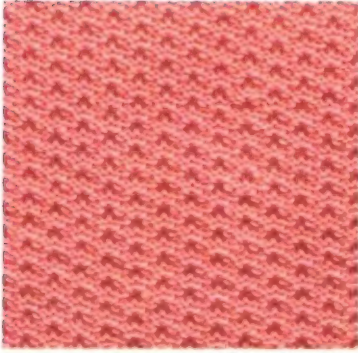

Card No. 2p

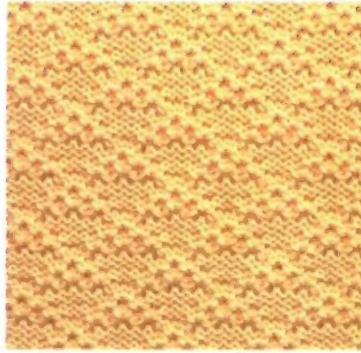

Card No. 3p



Card No. 4p



Card No. 5p



Card No. 8p

## TWO COLOUR TUCK STITCH PATTERN (No. 1p, 2p, 3p, 4p, 5p, 7p, 8p)

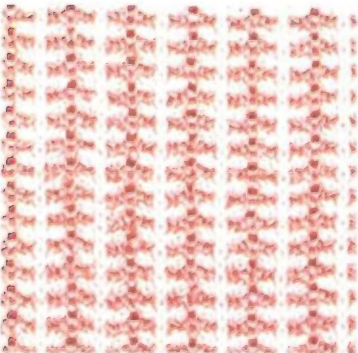

Card No. 2p



Card No. 4p



Card No. 7p

## SKIP STITCH PATTERN (No. 1p, 2p, 3p, 4p, 5p, 6p, 7p, 8p)



Card No. 2p



Card No. 3p



Card No. 5p



Card No. 6p



Card No. 7p

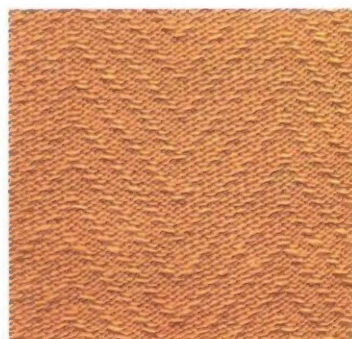

Card No. 8p

## TWO COLOUR SKIP STITCH PATTERN (No. 1p, 2p, 3p, 4p, 5p, 6p, 7p, 8p)



Card No. 3p



Card No. 8p

## WEAVING PATTERN (Card No. 1p, 2p)

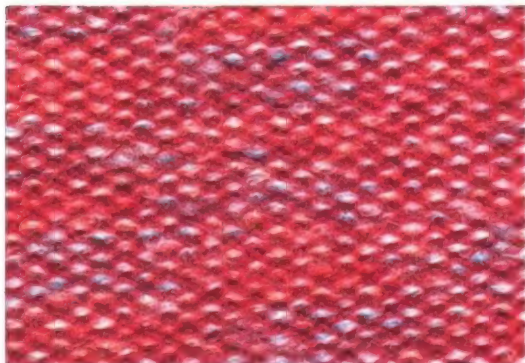

Card No. 1p

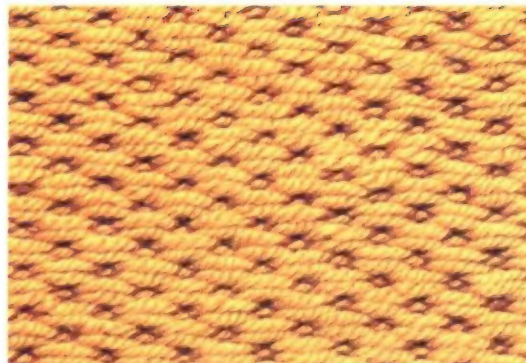

Card No. 2p

## WEAVING MOTIF PATTERN



Card No. 1p

## FAIRISLE PATTERN

(Card No. 1p, 2p, 6p, 7p, 8p, 9p, 10p, 11p, 12p, 15p)



Card No. 1p

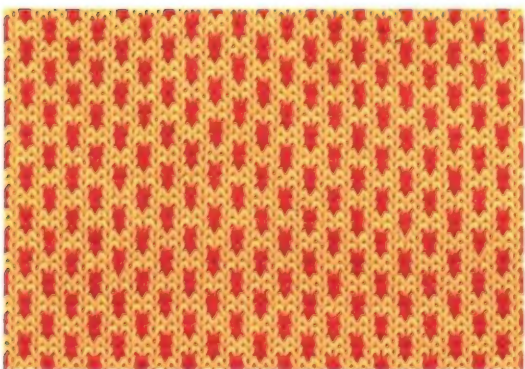

Card No. 2p



Card No. 6p

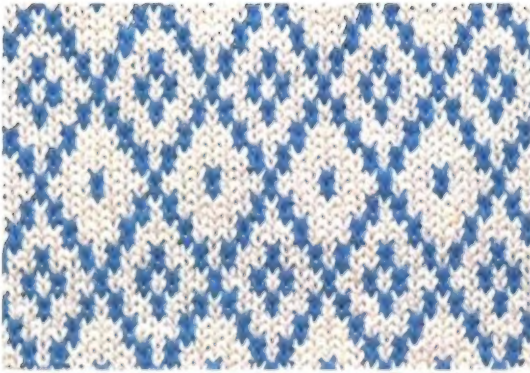

Card No. 7p



Card No. 8p



Card No. 9p

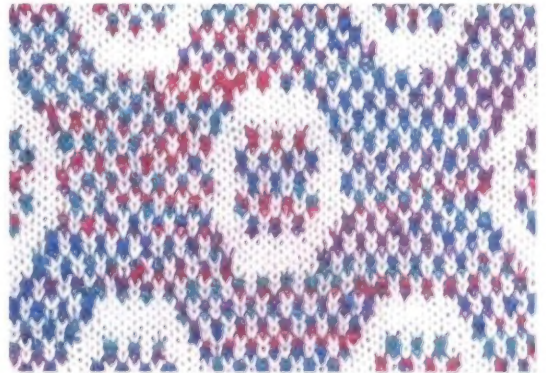

Card No. 11p



Card No. 12p



Card No. 15p

# DOUBLE LENGTH PATTERN



Card No. 9p

Normal

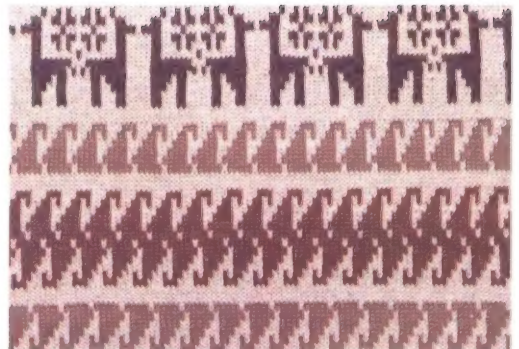

Card No. 9p

Double Length



# FAIRISLE MOTIF PATTERN



Card No. 10p

# THREAD LACE PATTERN (Card No. 1p, 11p, 12p, 13p, 14p, 15p)

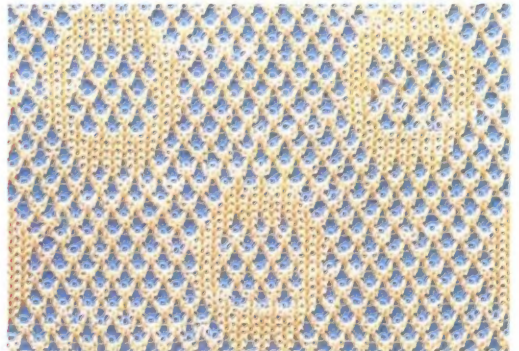

Card No. 11p



Card No. 12p

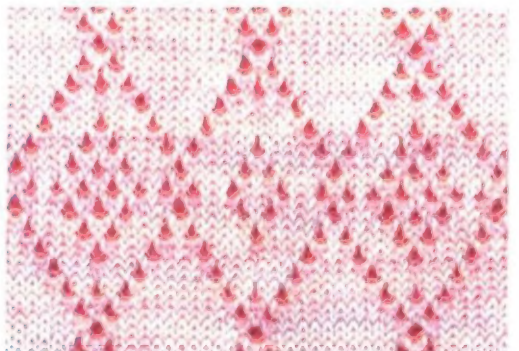

Card No. 13p



Card No. 14p



Card No. 15p

## THREAD LACE MOTIF PATTERN



Card No. 15p

## PLATING YARN KNITTING



FRONT

BACK

## TUCK STITCH PLATING YARN KNITTING

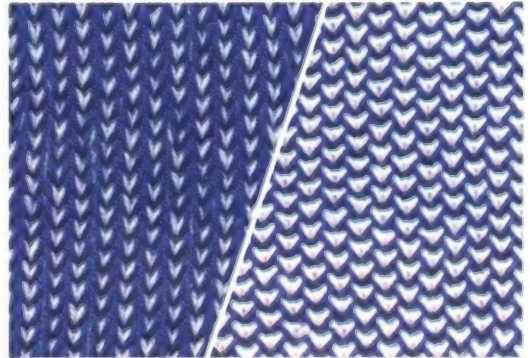

FRONT

BACK

Card No. 1p

# HOW TO USE THE KNITTING MACHINE

## 1. SETTING-UP THE KNITTING MACHINE

1) PLACE THE MACHINE ON A FIRM TABLE, WITH THE CARRYING CASE HANDLE AWAY FROM YOU AND UNLOCK THE CATCHES.

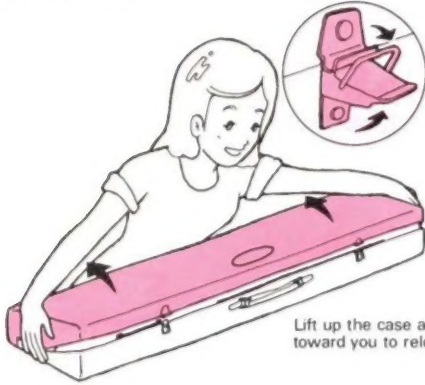

Lift up the case and pull it toward you to release the lid.

2) LOOSEN THE KNOB AND REMOVE THE CARRIAGE LOCK

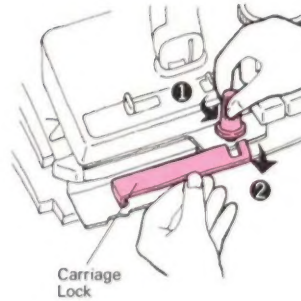

3) TAKE OUT THE SINKER PLATE ASSEMBLY FROM THE CARRYING CASE

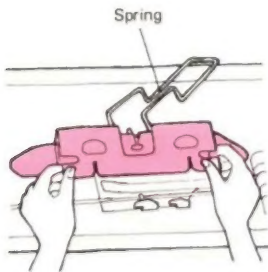

4) SCREW THE SINKER PLATE ASSEMBLY, ONTO THE KNIT CARRIAGE

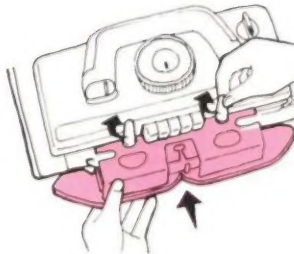

5) PULL THE CARRIAGE HANDLE UP TOWARDS YOU AND MOVE THE CARRIAGE TO THE RIGHT

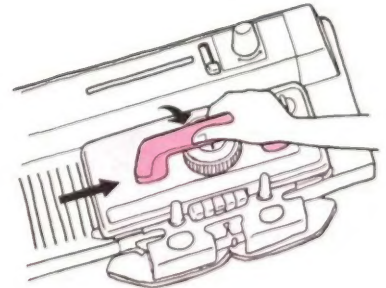

6) OPEN THE ACCESSORY BOX

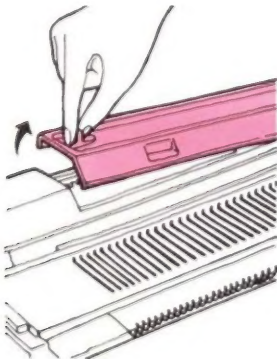

7) TAKE THE TWO TABLE CLAMPS OUT OF THE BOX

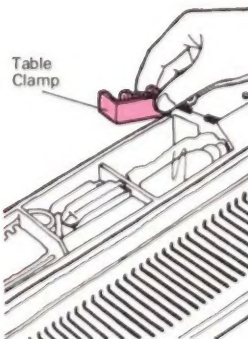

8) FASTEN THE MACHINE TO THE TABLE USING THE TABLE CLAMPS

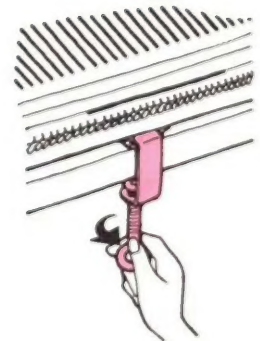

**9) SET THE ROW COUNTER ONTO THE TWO STUDS AT THE BACK OF THE NEEDLE BED**

Place onto studs and push to back of machine.

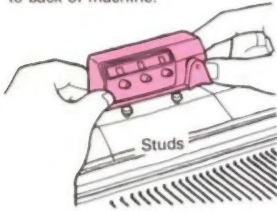

**10) TAKE OUT THE YARN TENSION UNIT**

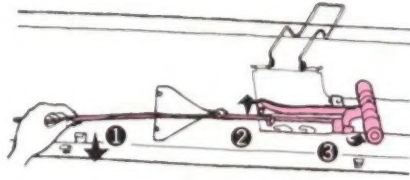

**11) RELEASE THE TAKE UP SPRINGS**

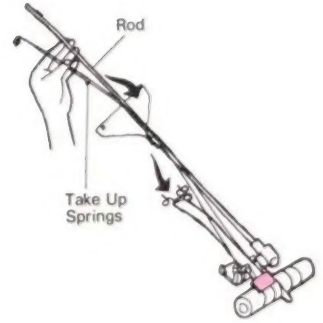

**12) PULL UP THE FRONT GUIDE ARM AS FAR AS IT WILL GO**

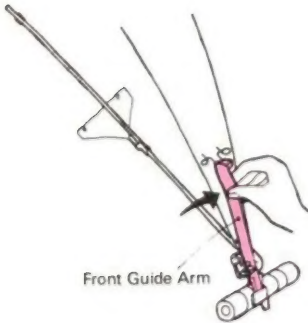

**13) THEN, PULL UP THE TAKE UP SPRINGS, UNTIL YOU HEAR A 'CLICK'**



**14) LIFT UP THE REAR YARN GUIDE**

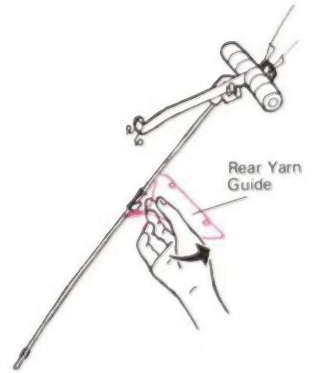

**15) INSERT THE END OF THE ROD INTO THE HOLE ON TOP OF THE MACHINE.**

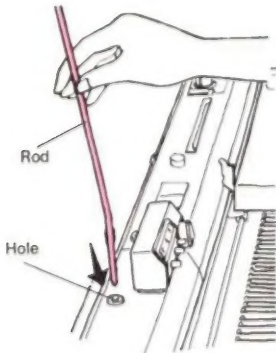

**AFTER SETTING-UP**



## 2. PARTS NAME

### K-CARRIAGE

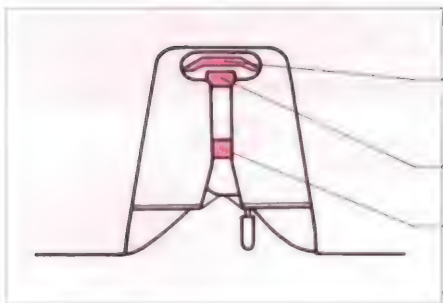
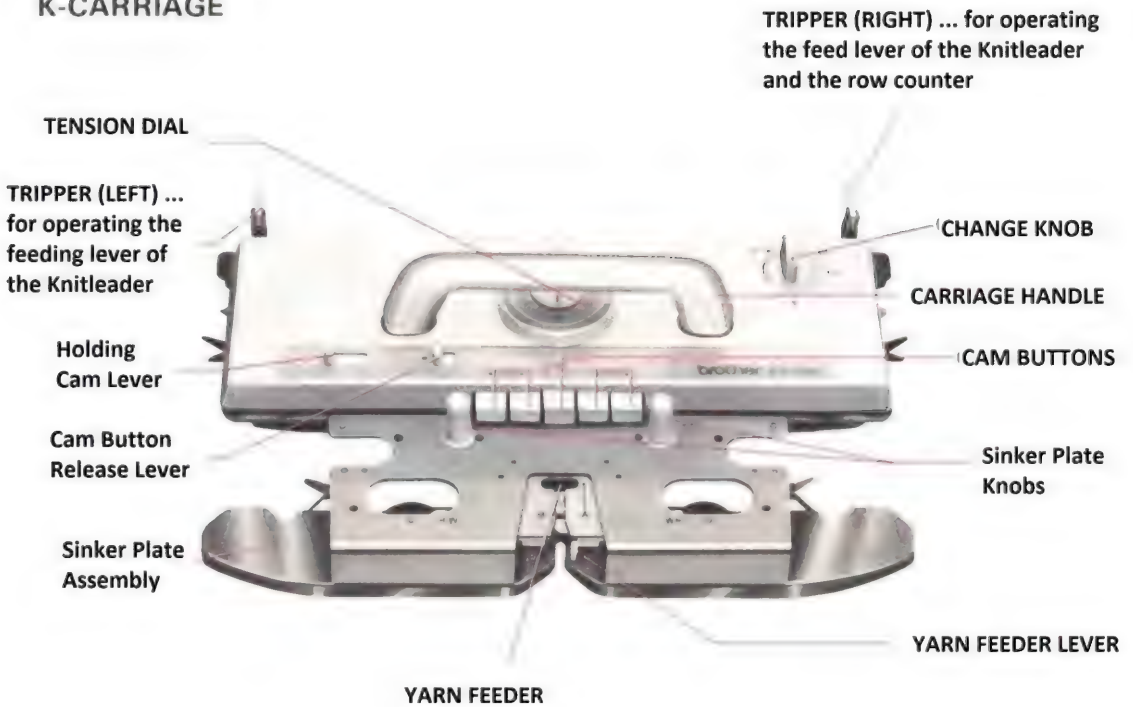

#### YARN FEEDER

PLATING YARN FEEDER

MAIN YARN FEEDER

YARN FEEDER B (FOR 2ND COLOUR  
IN FAIRISLE PATTERNING)

# MACHINE BODY

## YARN TENSION UNIT HOLES

Use the left hole first. Use the right one when knitting a motif pattern at the right side of the machine

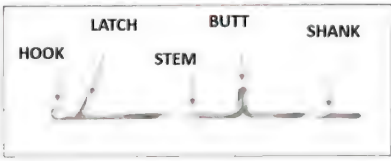
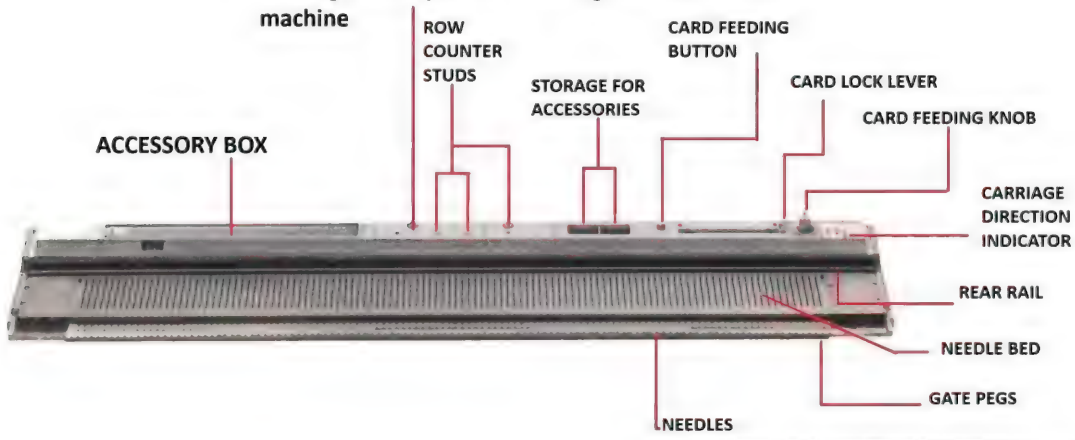

## MACHINE LID - FORMS A CARRYING CASE WHEN FITTED & LOCKED

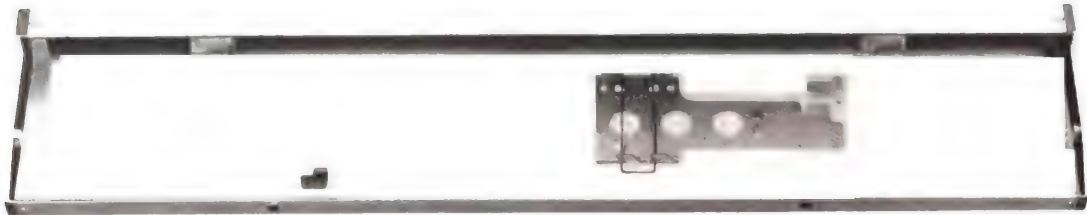

# ACCESSORIES

YARN MAST



CAST ON COMBS



KL-116  
KNITLEADER  
SCALES



STITCH TRANSFER TOOLS



L & R WHEEL BRUSHES



ROW COUNTER



1 X 1 NEEDLE PUSHER



CLAW WEIGHTS (6)



LATCH BRUSH



LATCH TOOL



MOTIF CAMS L & R

CROCHET HOOK



TAPESTRY NEEDLE

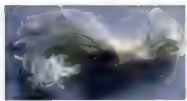

CAST ON THREAD



SPECIAL KNITTING OIL



SPARE NEEDLES (2)



PUNCH CARD HOLDER PIN



TABLE CLAMPS (2)



SET OF 20 PUNCHCARDS



CARRIAGE LOCK



PUNCH CARD SNAPS (4)



YARN WAX

### 3. BEFORE STARTING TO KNIT

#### (1) NEEDLE POSITION

On either side of the needle bed, there appears the letters A, B, D and E.

A ... Non Working Position

B ... Working Position (used for general knitting)

D ... Patterning Position (Selected needles are brought up to this position by the Knit Carriage.)

E ... Holding Position (The needle will 'hold' stitch on the needle until released) Used when shaping edges, socks etc.

Return needles to A when work is finished.

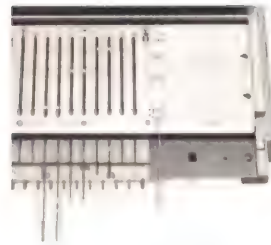

#### (2) ROW COUNTER

Row Counter shows the number of rows knitted with the Knit Carriage. When you want the numbers to go back to '0' ... turn the counter knob in the direction of the arrows.

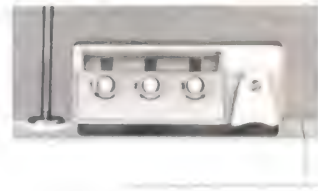

#### (3) TENSION DIAL

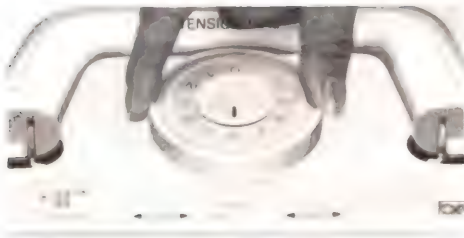

This dial is graduated from 0 to 10, each space being subdivided into three parts.

The size of the stitch is adjusted by the tension setting on the Carriage Tension Dial. 0 denotes the tightest tension (the smallest stitch) and 10 is the loosest tension (biggest stitch).

Adjust the dial according to the thickness of your yarn.

#### (4) CAST-ON COMB

You can choose the length according to the number of needles.

114 stitches full length or ...  
84 stitches med length and ...  
30 stitches short length

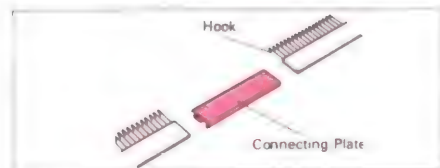

## (5) CAM BUTTON AND CAM BUTTON RELEASE LEVER

USE THE CAM BUTTONS ACCORDING TO THE PATTERN AND RELEASE THE SELECTION BY SLIDING THE CAM RELEASE LEVER TO THE RIGHT.

### CAM BUTTONS

#### TUCK STITCH PATTERN

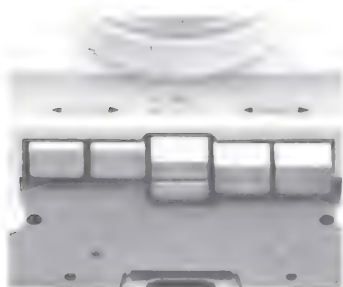

#### FAIRISLE PATTERN



#### THREAD LACE PATTERN

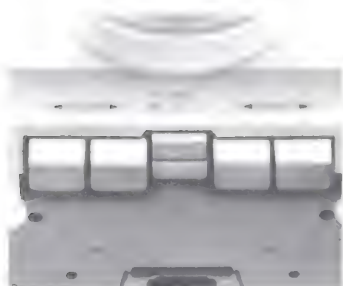

#### SKIP STITCH PATTERN

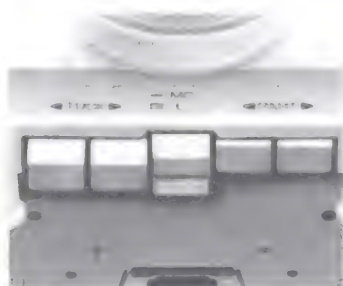

### CAM BUTTON RELEASE LEVER

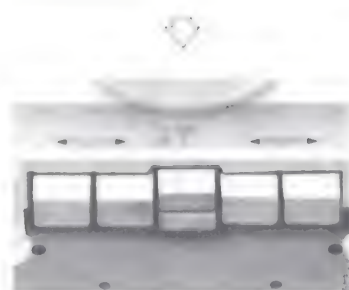
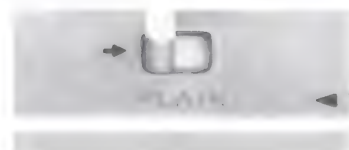

## (6) CHANGE KNOB



**N ... FOR STOCKING STITCH AND LACE PATTERNS**

**KC ... FOR STITCH DESIGNS THAT REQUIRE NEEDLE SELECTION**

**SM ... FOR SINGLE MOTIFS**

**CR ... TO RELEASE THE KNIT CARRIAGE FROM THE NEEDLE BED**

# 4. BASIC OPERATION

## (1) THREADING THE YARN

Thread the Yarn Tension Unit following the order shown

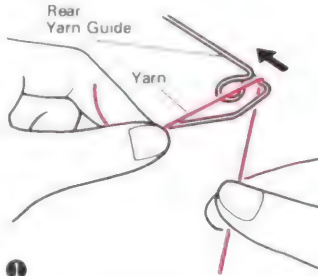
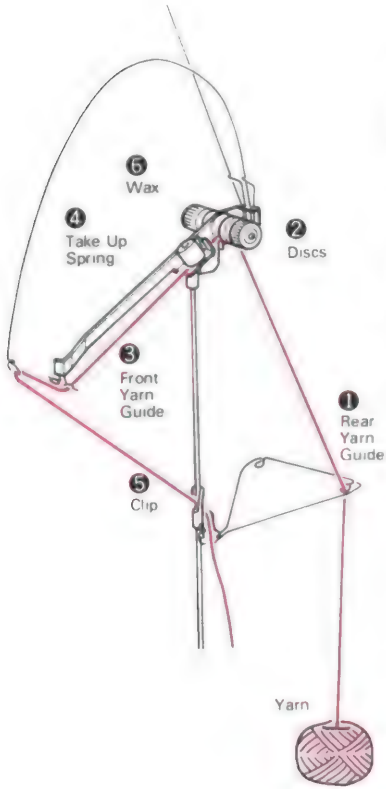

**1** PASS THE YARN FROM THE CONE THROUGH THE REAR YARN GUIDE, SLIDING THE YARN THROUGH THE EYELET

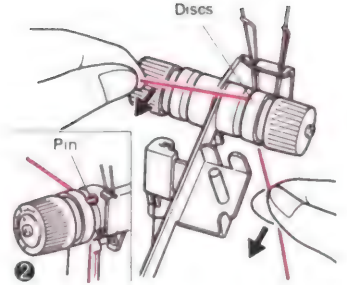

**2** PASS THE YARN UNDER THE PIN AND BETWEEN THE TWO DISCS FROM BEHIND. (HOLD THE YARN AS SHOWN ABOVE AND PULL IT TOWARDS YOU SO THAT THE YARN GOES UNDER THE PIN)

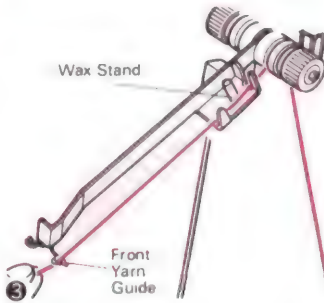

**3** THREAD THE FRONT YARN GUIDE

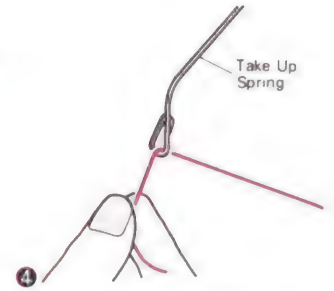

**4** THREAD THE YARN INTO THE EYELET OF THE TAKE UP SPRING



MEDIUM YARN



THICK YARN



CHUNKY YARN

SET THE ARROW MARK, ACCORDING TO YARN THICKNESS

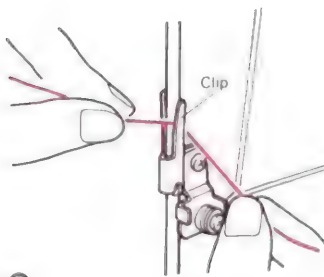
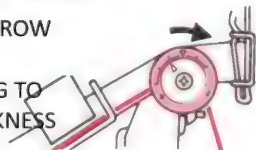

**5** CLIP THE YARN UNDER THE YARN CLIP

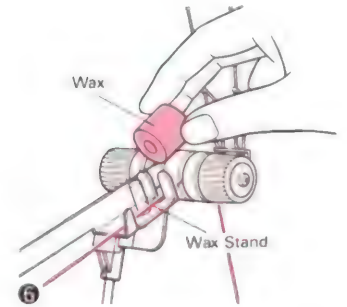

**6** SET THE WAX RING FROM THE ACCESSORY BOX, ONTO THE TENSION UNIT SPINDLE.

THE WAX WILL ENSURE THE YARN RUNS SMOOTHLY

## (2) STOCKING STITCH

1) SET THE KNIT CARRIAGE AS SHOWN IN THE DIAGRAM

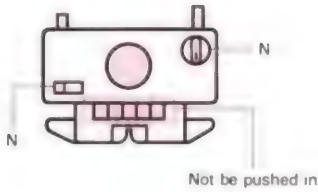

2) BRING FORWARD 40 NEEDLES TO B POSITION, USING FLAT SIDE OF 1/1 NEEDLE PUSHER. (20 NEEDLES ON EACH SIDE OF MARK '0' )



3) TAKE THE CARRIAGE ACROSS THE NEEDLE BED A FEW TIMES TO ALIGN THE NEEDLES, FINISHING WITH CARRIAGE ON THE RIGHT



4) PUSH THE YARN FEEDER LEVER TO THE LEFT

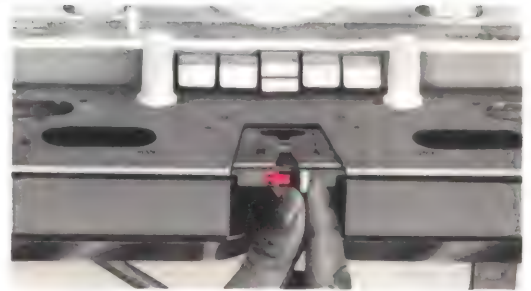

5) THREAD THE YARN INTO THE YARN FEEDER

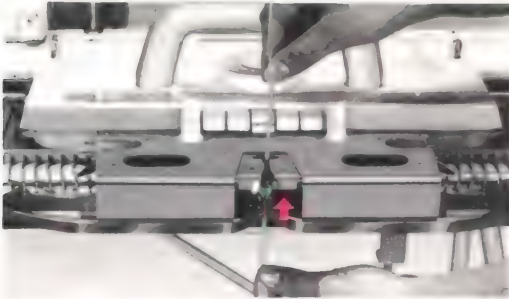

6) CLOSE THE YARN FEEDER LEVER



7) HOLD THE YARN END SECURELY

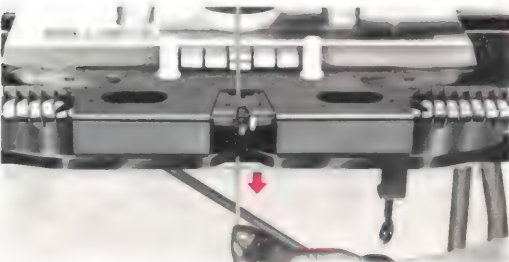

8) MOVE KNIT CARRIAGE TO THE LEFT SLOWLY. ONCE THE NEEDLES CATCH THE YARN, YOU CAN LET GO OF THE YARN END

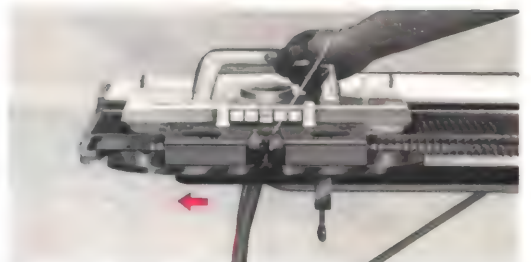

9) ADJUST THE END NEEDLE TO B POSITION

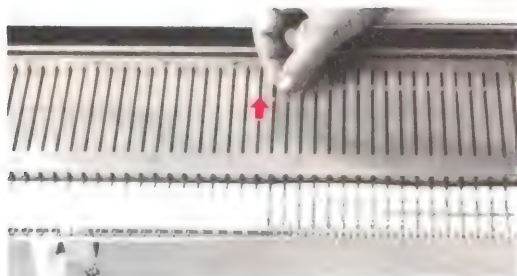

11) HANG THE CAST ON COMB WITH HOOKS FACING TOWARD THE MACHINE. PULL THE YARN THROUGH THE END TWO HOOKS AS SHOWN.

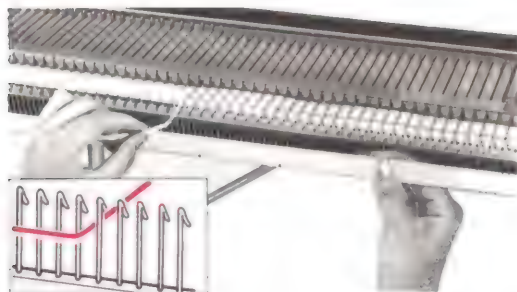

10) TAKE THE CAST ON COMB OUT OF THE CASE AND SHORTEN IT TO 84 NEEDLES. PUT THE CONNECTING PLATE INSIDE.

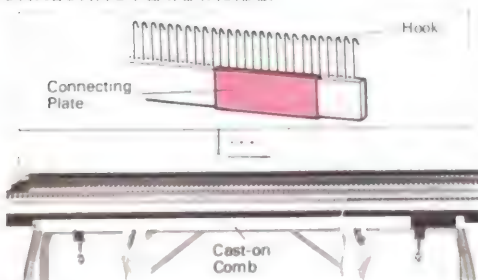

12) HOOK THE CAST ON COMB INTO POSITION AND PULL DOWN.

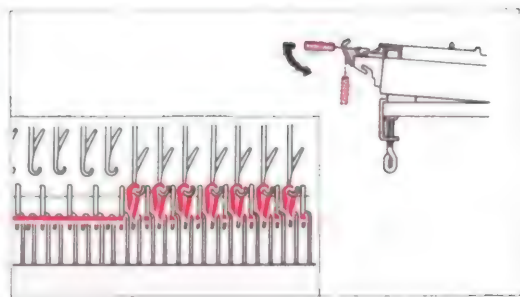

13) SLIP THE LOOSE END INTO THE CONNECTING PLATE FROM THE BACK

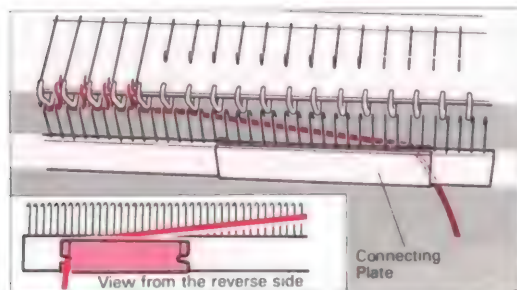

14) KEEPING THE COMB HORIZONTAL, HANG ON THE CLAW WEIGHTS

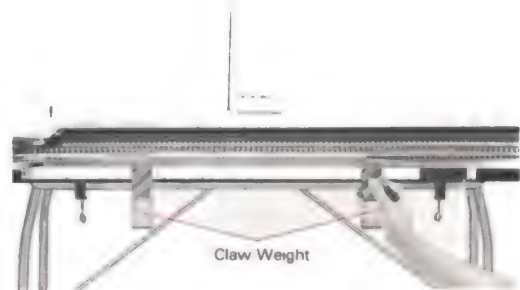

15) MOVE THE CARRIAGE TO THE RIGHT, HOLDING THE YARN AS SHOWN, SO NO LOOPS ARE FORMED

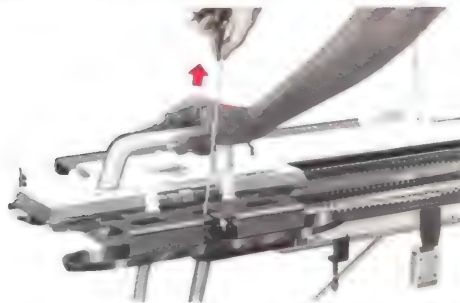

16) MOVE THE KNIT CARRIAGE TO LEFT, THEN RIGHT. THIS IS STOCKING STITCH.

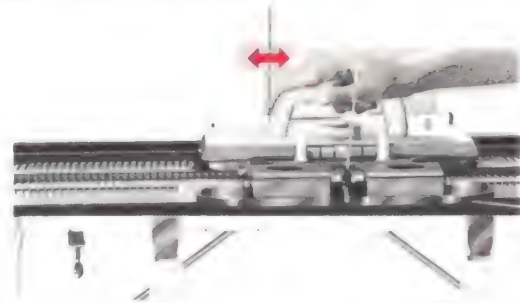

**NOTE:**

1) ENSURE KNIT CARRIAGE CLEARS THE LAST KNITTED STITCH, BEFORE YOU MAKE THE RETURN PASS

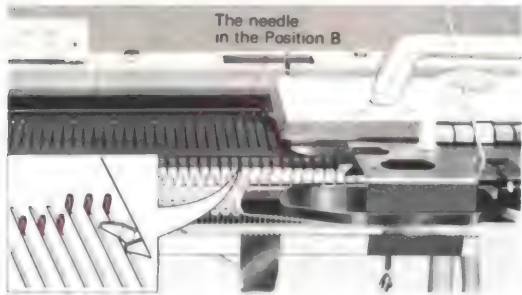

2) WHEN YOU KNIT WITH COTTON AND SYNTHETIC YARN, SET THE RUBBER WHEEL TO THE WORKING POSITION ( SEE PAGE 22).

The Plain and Purl Side of the Knitting

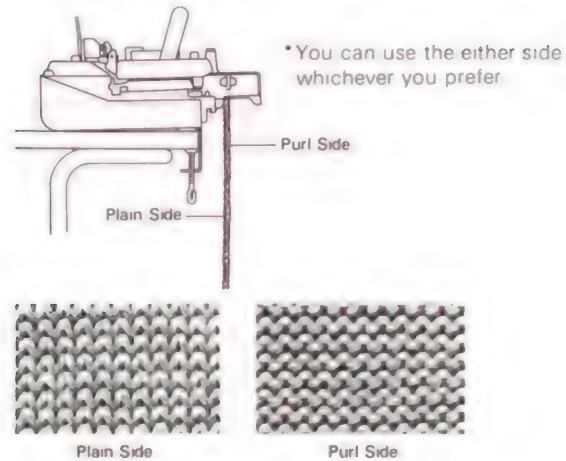

# 5. PATTERN KNITTING

THE PUNCHCARD PRODUCES VARIOUS STITCHES AUTOMATICALLY  
 THE NEEDLES THAT CORRESPOND TO THE PERFORATIONS, ARE SELECTED TO POSITION 'D'  
 DO NOT FOLD THE PUNCH CARDS

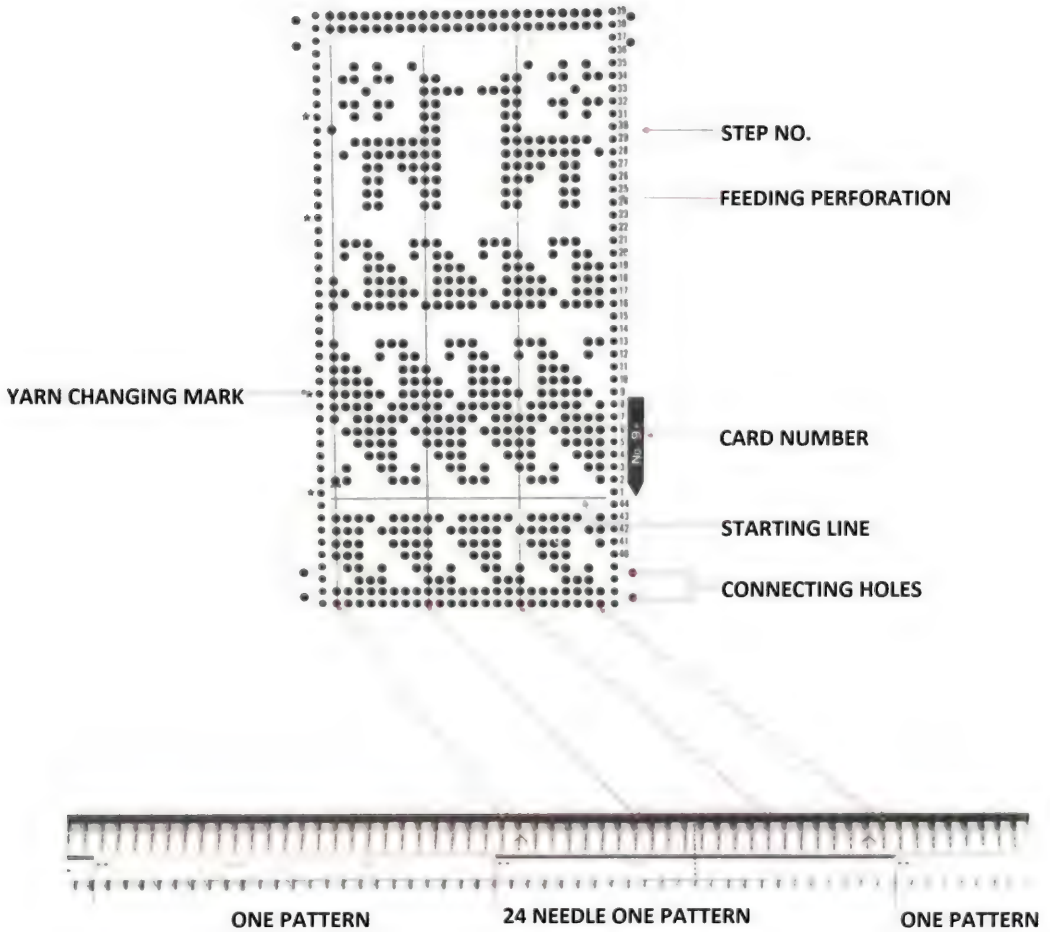

THE MACHINE HAS A 24 STITCH PATTERN REPEAT CENTRED OVER THE "0" ON THE NEEDLE STRIP

## HOW TO SET THE PUNCH CARD

1) INSERT THE PUNCH CARD HOLDER PIN IN THE HOLE BEHIND THE PUNCHCARD SLOT



2) INSERT THE PUNCH CARD STRAIGHT INTO THE SLOT WITH THE NUMBER FACING YOU. MAKE SURE THE START LINE IS PARALLEL TO THE PANEL EDGE



3) TURN THE FEEDING KNOB - PRESSING DOWN THE BUTTON - TO FEED THE PUNCHCARD

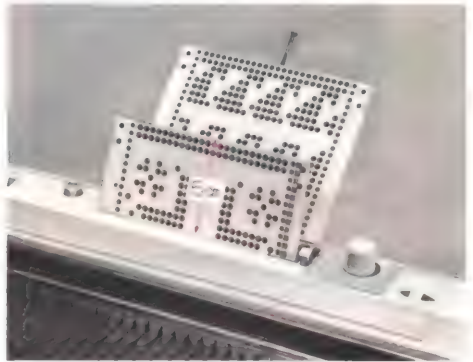
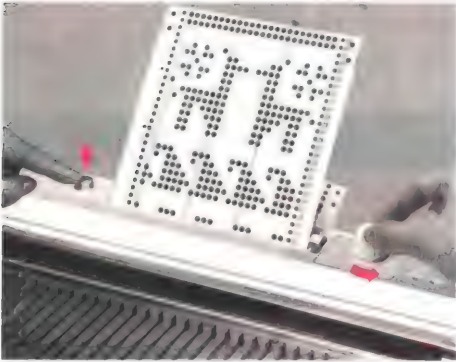

4) USING THE PLASTIC SNAPS, JOIN THE CARD (FRONT OVER BACK) TO ALLOW IT TO ROTATE

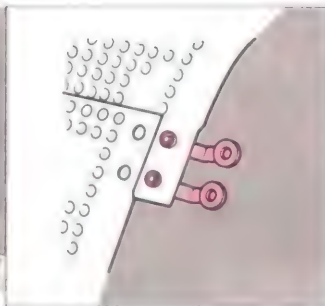
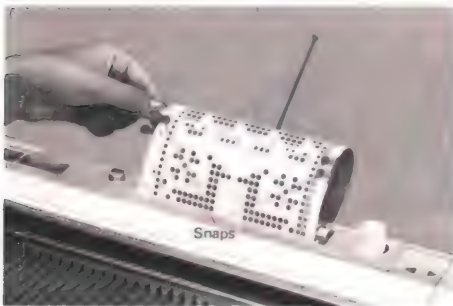

# BASIC STEPS TO PATTERN KNITTING

The first steps to all patterning are the same - so study these steps carefully.

\*CARRIAGE DIRECTION INDICATOR shows which direction the carriage is moving



\*END NEEDLE SELECTION MECHANISM - When the change knob is set to KC on the knit carriage, each end needle in B position is selected on every row - regardless of the punch card pattern - which prevents the end needles from dropping stitches. To cancel this mechanism - refer to page 42.



Perforation of the card



End needle selected by the End Needle Selection Mechanism

## STEP 1

1) Cast on and knit a few rows in stocking stitch. Place knit carriage at left (except for double length patterns)

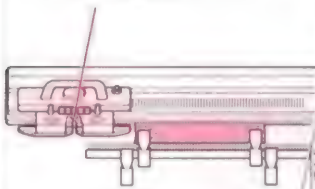

2) Insert card and lock on row 1. (Check that the card is suitable for the pattern required). Rotate card to start line.

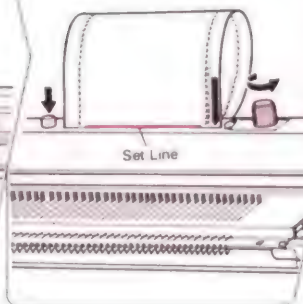

3) Set the card lock lever to the ● mark

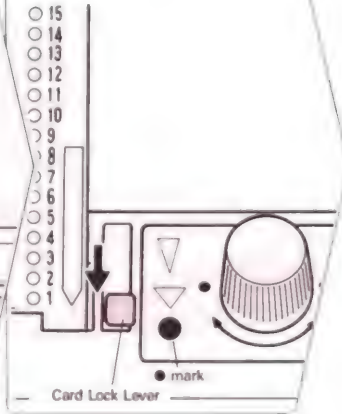

## STEP 2

1) SET THE CHANGE KNOB TO 'KC' (OR SM) POSITION

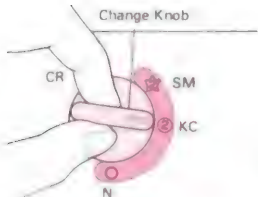

2) MOVE THE KNIT CARRIAGE SLOWLY TO THE RIGHT (OR LEFT IN DOUBLE LENGTH PATTERN) AND NEEDLES ARE SELECTED TO D POSITION

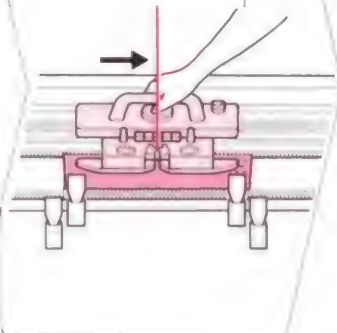

## STEP 3

1) PUSH THE REQUIRED CAM BUTTONS OR SET THE WHEEL BRUSHES, ACCORDING TO YOUR PATTERN

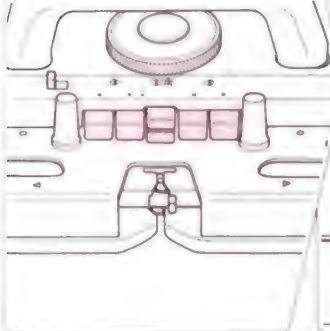

## STEP 4

1) SET THE CARD LOCK LEVER TO THE "▼" OR "▲" MARK

- 15
- 14
- 13
- 12
- 11
- 10
- 9
- 8
- 7
- 6
- 5
- 4
- 3
- 2
- 1

Card Lock Lever  
▼ mark

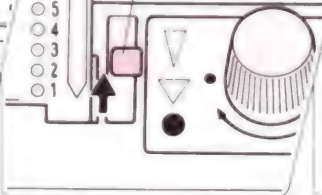

2) BEGIN KNITTING

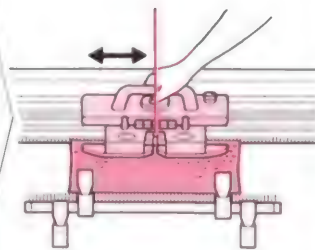

# TUCK STITCH PATTERN (You can use the Card No. 1p, 2p, 3p, 4p, 5p, 7p, 8p)

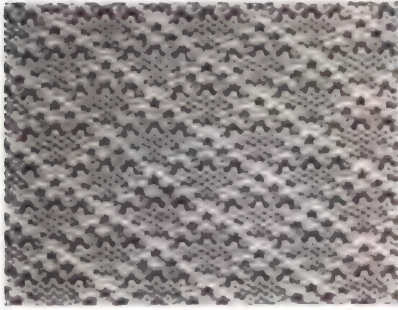

CARD 3P

## 2) Hang Claw Weights

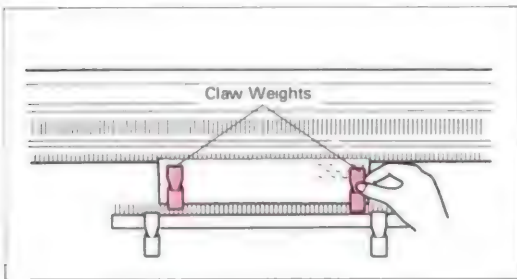

4) Remove the sinker plate from the knit carriage and push and slide both rubber wheels under the plate, to place them into working position

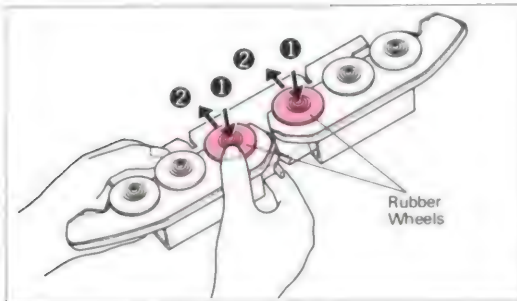

6) Remove the wheel brushes from the accessory case and fit them to the sinker plate.

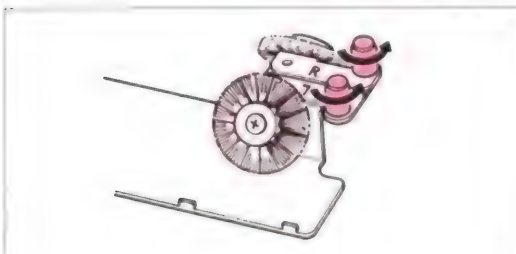

1) **STEP 1** After knitting several rows of stocking stitch, place the carriage at the left., then set the card and lock lever at the • mark

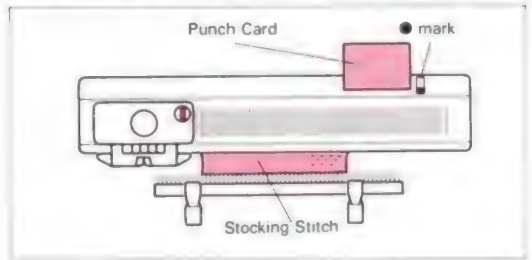

3) **STEP 2** Set the change knob to the KC position and move the knit carriage from left to right. The needles are now selected

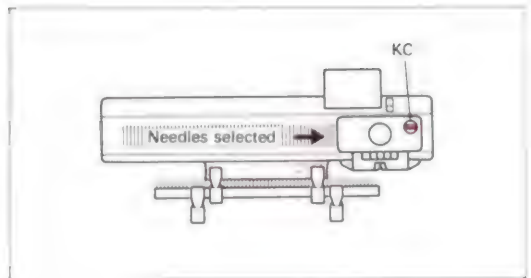

5) **STEP 3** Push both tuck cam buttons in

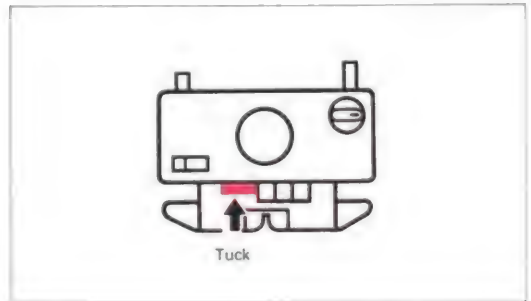

2. Put the wheel brush (L) into the wheel shaped slot on the left of the sinker plate and insert the screw to the left of the 'T' mark

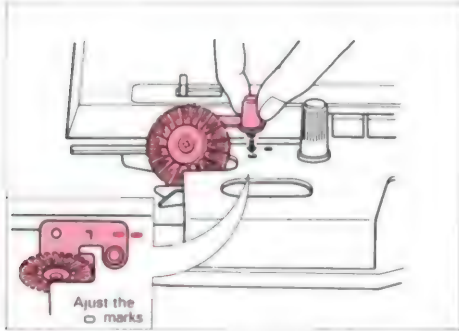

3. Insert the small pin on the sinker plate into the hole of the wheel brush, then tighten screw

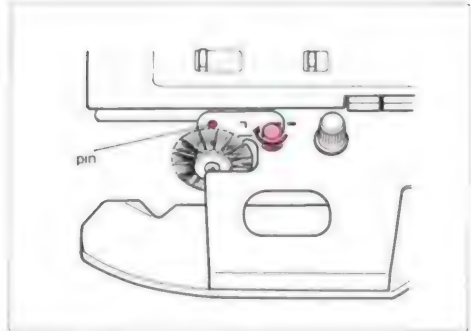

4. Fix the other brush on the right hand side

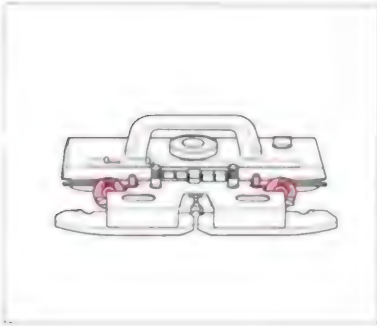

7) STEP 4 Set the card lock lever at the ▽ mark, then operate the knit carriage and knit. Re-hang the claw weights every 10 cms

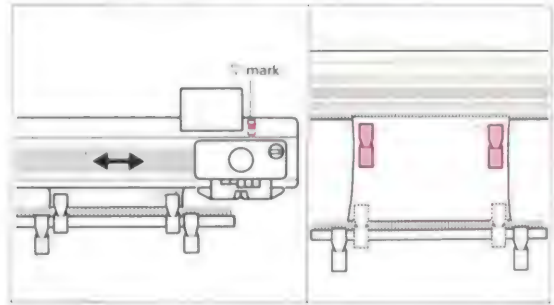

**\*NOTE (IN TUCK/2 COLOUR TUCK STITCH PATTERN)**

**AFTER KNITTING THE PATTERN:**

Remove the tuck brushes and return sinker plate rubber wheels back to normal working position

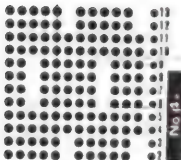
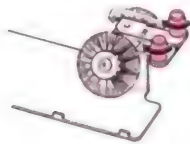

Card No 4p

More than three rows

Make sure that **two needles** don't come side by side in B position

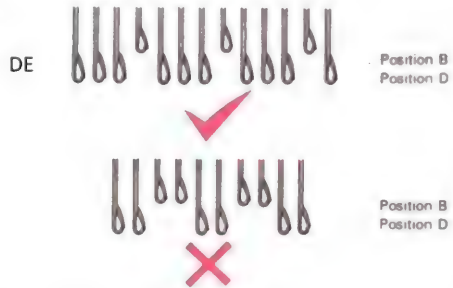

Do not use thicker yarn when there are more than three rows of perforations continuously on the punch card

## TWO COLOUR TUCK STITCH PATTERN

This is worked the same as Tuck Stitch pattern - except the yarn is changed every two rows. In the case of Card No 4p - change at the ★ mark.

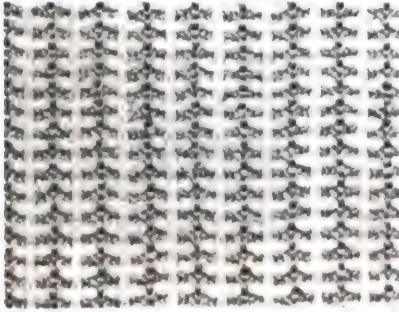

Card No 2p

1) Thread the yarn tension unit as in picture below and follow the same procedure as given in 1~7 tuck stitch pattern section. Knit 2 rows.

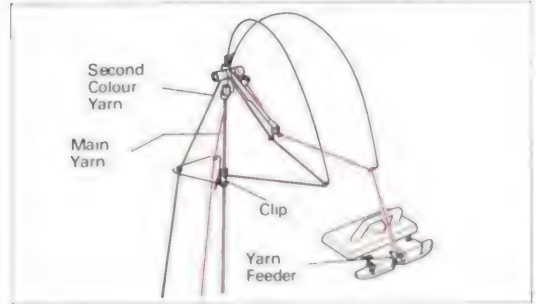

2) Take the main yarn out of the feeder and hook it at the edge of the machine to hold it.

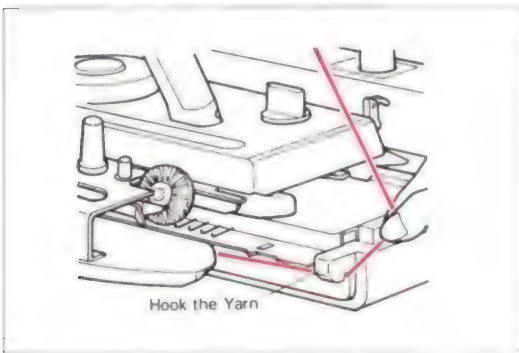

3) Thread the 2nd colour yarn and knit two rows.

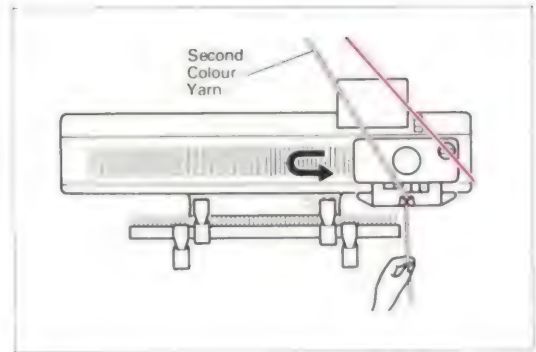

4) Take second colour yarn out of the feeder and hook it at the edge of the machine

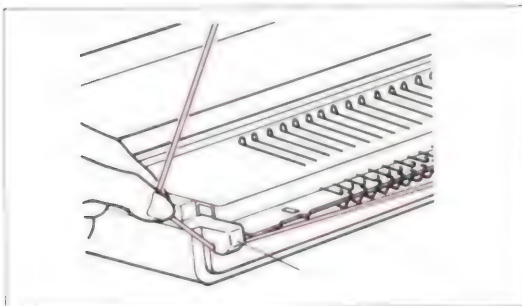

5) Change the yarn in the yarn feeder every two rows

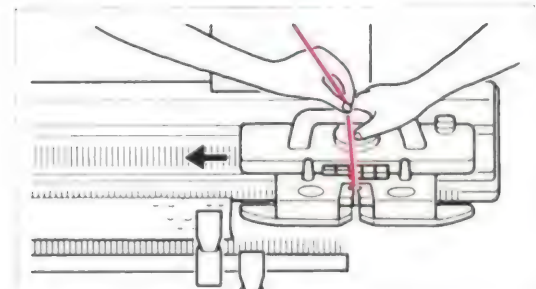

Move the carriage to the right - holding the yarn in your left hand, to prevent yarn slack. Re-hang claw weights

\*Refer to the NOTE on page 23

## SKIP STITCH PATTERN (You can use the Card No. 1p, 2p, 3p, 4p, 5p, 6p, 7p, 8p)



Card No 6p

- STEP 1** After knitting several rows of stocking stitch, place the carriage at the left  
Set the punch card and card lock lever at • mark  
Hang the claw weights

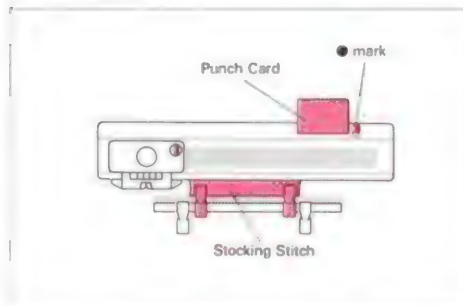

- STEP 2** Set change knob to the KC position.  
Move the carriage to the right.  
The needles are selected.

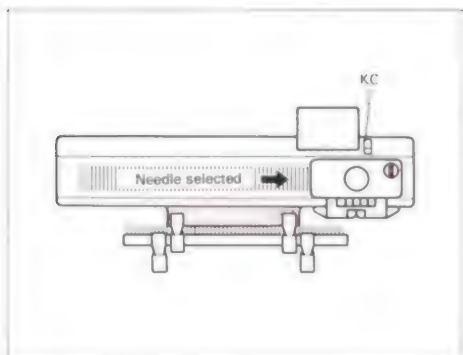

- STEP 3** Push both part buttons at the same time.

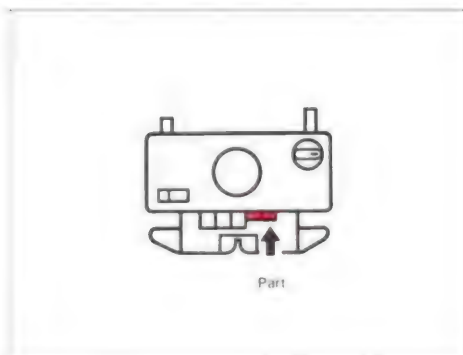

- STEP 4** Set the card lock lever to V mark, then operate the knit carriage and start knitting.  
Re-hang the claw weights every 5cm or so.

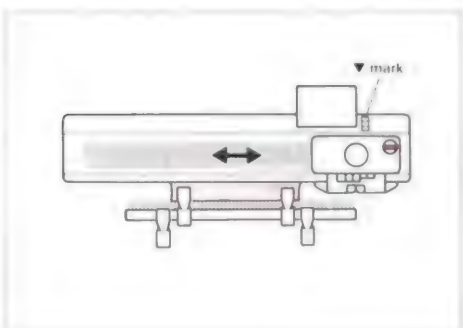

## TWO COLOUR SKIP STITCH PATTERN

This pattern is the same as skip stitch, except the yarn is changed every two rows

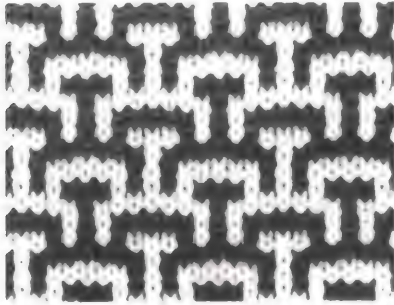

Card No 3p

1) Thread the yarn tension unit as shown in the picture

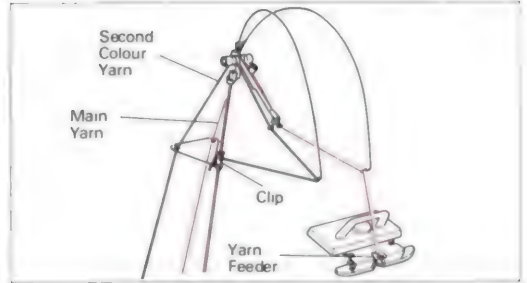

2) Follow the same procedure as explained in 1~4 in Skip Pattern section.

Knit two rows

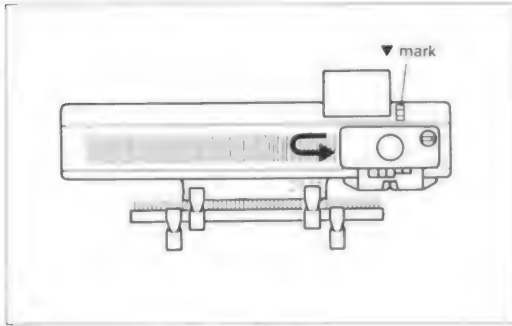

3) Take the main yarn out of the yarn feeder and hook it at the edge of the machine, to hold it.

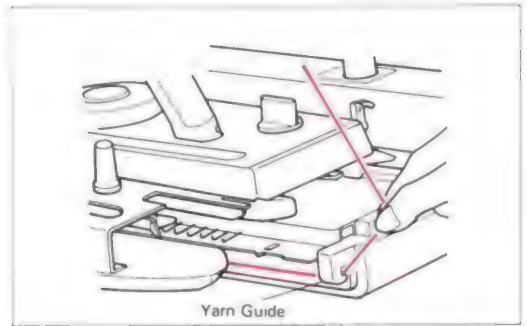

4) Thread up the 2nd yarn colour and knit two rows

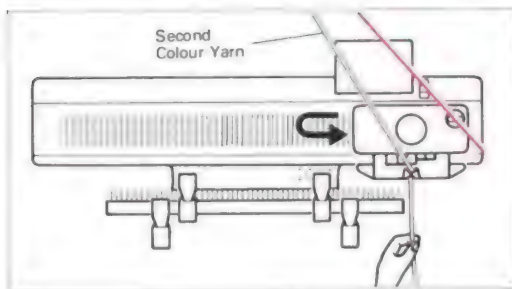

5) Change the yarn in the main feeder, every two rows.

### NOTE

... IN TWO COLOUR TUCK/SKIP STITCH PATTERN ...

**MAKE SURE THAT THE TWO YARNS DO NOT CROSS !!**

## WEAVING PATTERN (You can use the Card No. 1p, 2p)

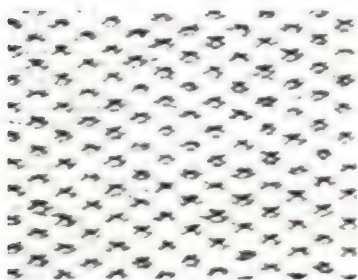

Card 2p

- 1) Thread the yarn tension unit as shown in the picture. Adjust the discs, according to thickness of weaving yarn. (Refer to page 14)

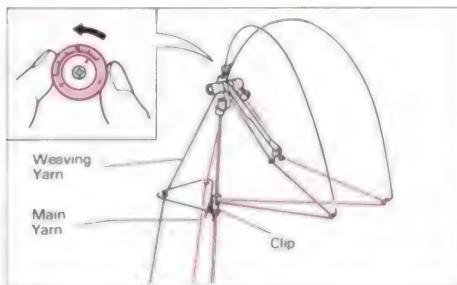

- 2) **STEP 1** After knitting several rows of stocking stitch, place the knit carriage at the left. Set the punch card and card lock lever at • mark. Hang the claw weights

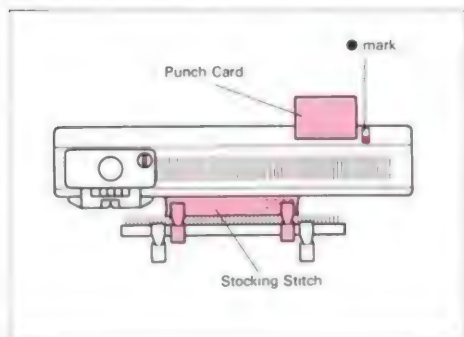

- 3) **STEP 2** Set the change knob to the KC position and move the carriage from left to right. The needles are selected.

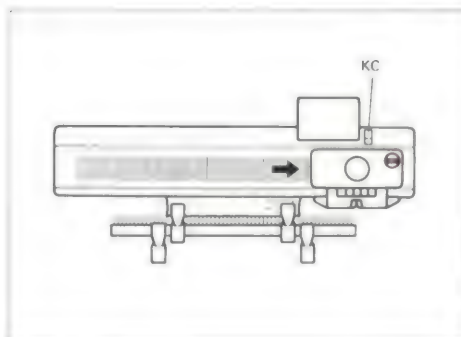

- 4) **STEP 3** Set the wheel brushes. Remove wheel brushes from the case.

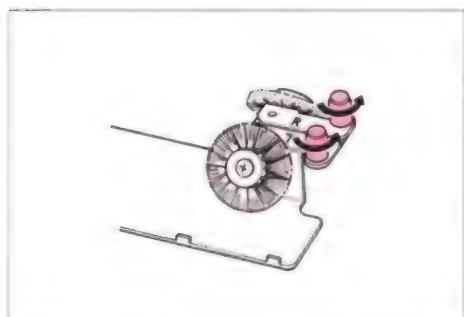

- 2) Put the wheel brush (L) into the left oval opening in the sinker plate and insert the screw

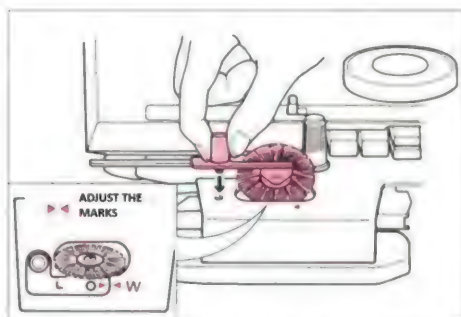

3) Insert the pin on the sinker plate into the hole of the wheel brush and tighten the screw

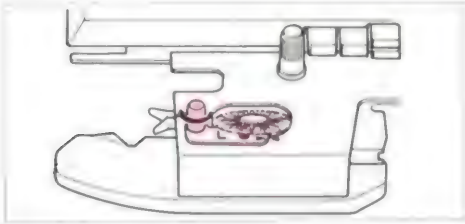

4) Fit the second brush on the right of the sinker plate

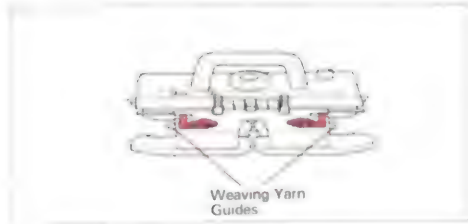

5) **STEP 4** Set the card lock at ▼ mark

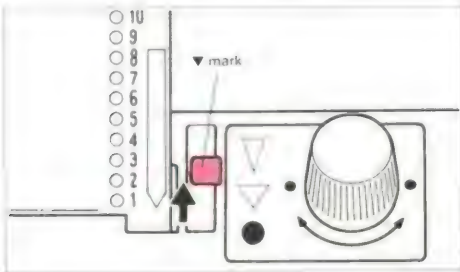

6) Hold the end of the weaving yarn with your left hand and thread it in the weaving yarn guide at the left side of the knit carriage. Operate Knit carriage and release yarn end after knitting one row.

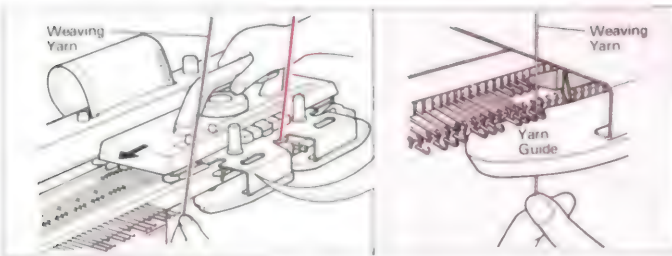

7) Remove the weaving yarn from the left weaving yarn guide by moving knit carriage slightly to the left. Pass the weaving yarn under the knit carriage and place it in the right weaving yarn guide.

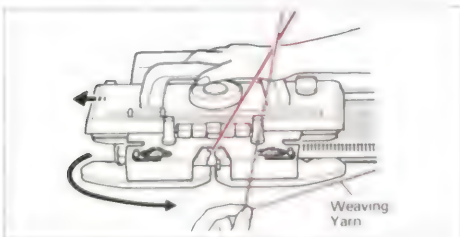

8) Move the knit carriage to the right. Continue knitting and remember to change the weaving yarn in the weaving yarn guide before every row. Re-hang the claw weights every few cms.

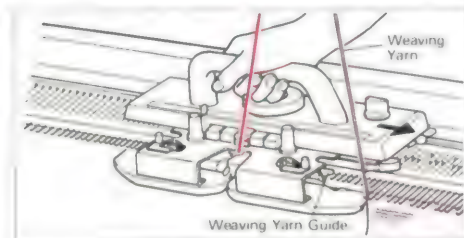

**AFTER KNITTING THE WEAVING PATTERN**  
 Remove the wheel brushes from the sinker plate

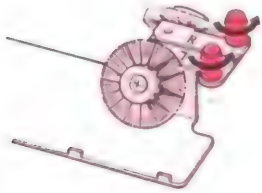

**NOTE**

IF USING MORE THAN TWO WEAVING YARNS here is another method:  
 Lay weaving yarn across the needles from carriage side as shown below - then operate knitting carriage

Hold the yarn lightly



Direction of knit carriage

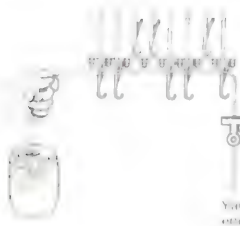

Weight the yarn lightly with a clip



Three needles side by side are the limit for successful weaving on the machine.



**WEAVING MOTIF PATTERN**

(Manual Operation)

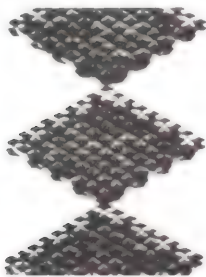

1) Draw a diagram (on graph paper) before you knit - or draw pattern on your Knitleader sheet.



2) Follow the procedure explained in Weaving Pattern (No: 1~5)

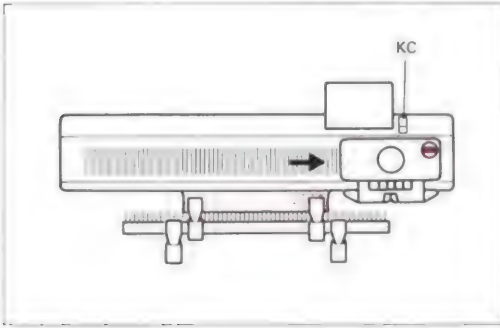

4) Lay the weaving yarn according to the diagram of the next row

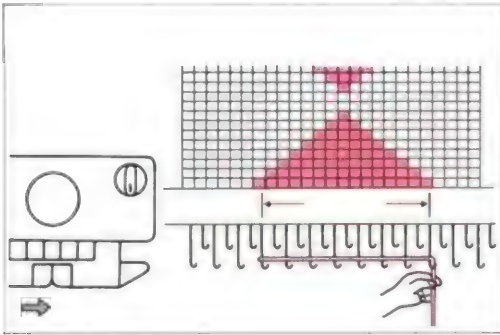

\* Remember to return the Wheel Brush to the accessory box

3) The weaving yarn should be laid in the opposite direction to where the carriage is resting. (Refer to the **NOTE** in Weaving Pattern). Operate the knit carriage

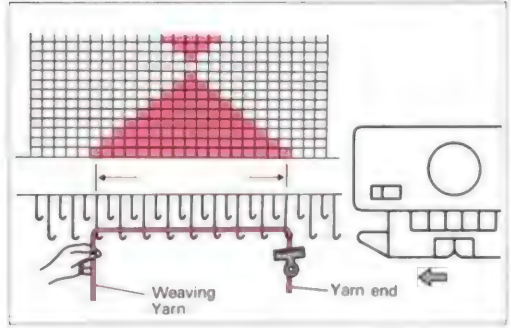

5) Continue to knit, referring to the diagram. Re-hang the claw weights

**FAIRISLE PATTERN** (You can use the Card No. 1p, 2p, 6p, 7p, 8p, 9p, 10p, 11p, 12p, 15p)

Knitting two different colour yarns in the same row

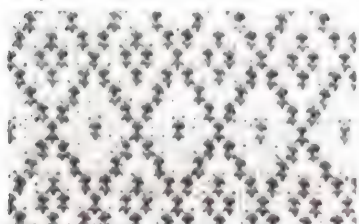

Card No 7p

1) Thread and clip the yarn as shown in the picture

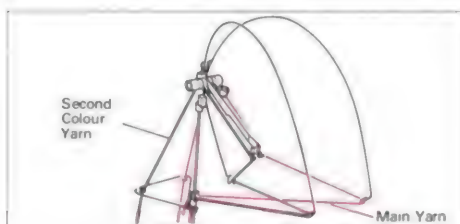

2) **STEP 1** Knit several rows of stocking stitch - put carriage on the left. Insert the punchcard and set the punch card lever to the • mark

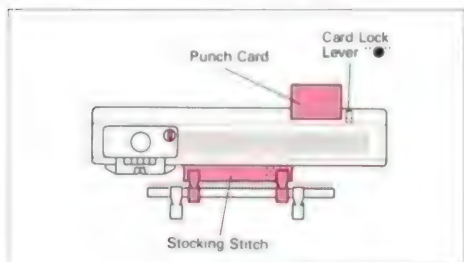

3) **STEP 2** Set the change knob to the KC position and move carriage from left to right. The needles are selected.

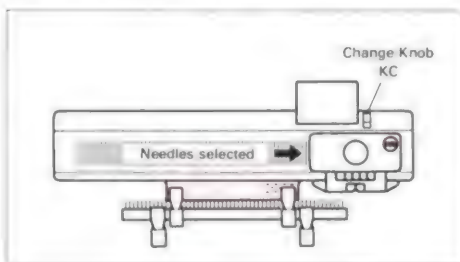

4) **STEP 3** Push the upper MC button

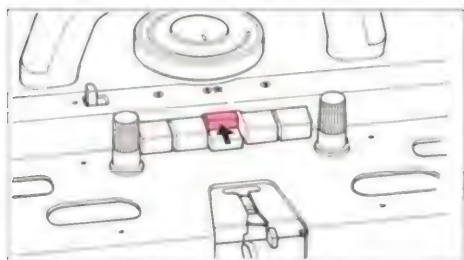

5) **STEP 4** Set the card lock lever at the V mark

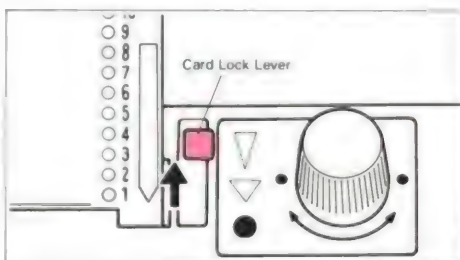

6) Thread the second colour yarn into the yarn feeder B (without opening the feeder lever)

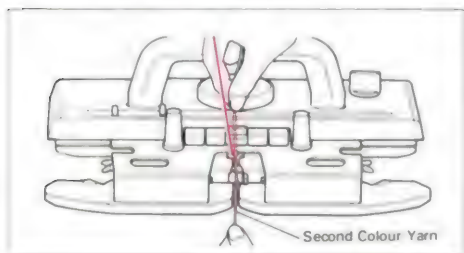

7) Operate the knit carriage whilst holding the yarn end with your left hand

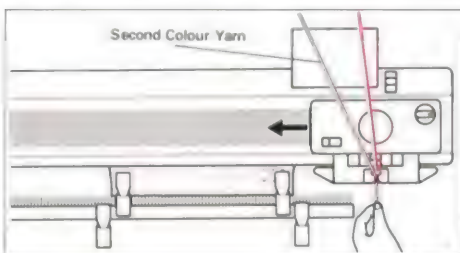

**WHEN USING MORE THAN THREE COLOURS OF YARN**

- 1) Thread the main colour yarn at the right side of the yarn tension unit
- 2) Place the 2nd colour yarn at your feet (thread up in tension units if many rows of this colour to be knitted)
- 3) Hang a weight (peg or clip) on the loose end of the second yarn

- 4) Hold yarn in left hand as you move the knit carriage, to take up yarn slack

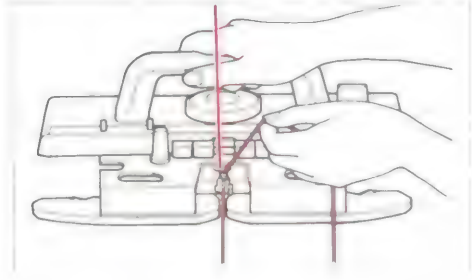
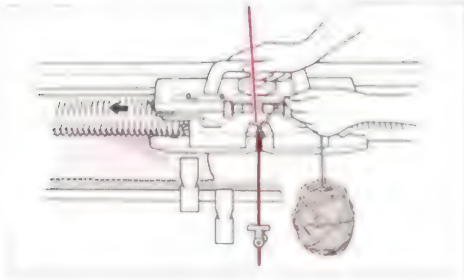

- 5) Change the 2nd colour yarn in the yarn feeder B to the third colour when the asterisk on the left side of the punch card appears at the start line.

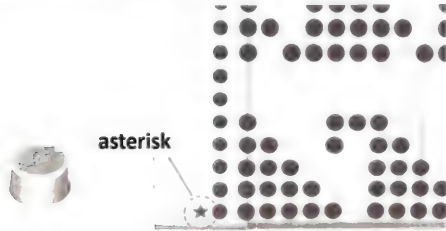

**NOTE**

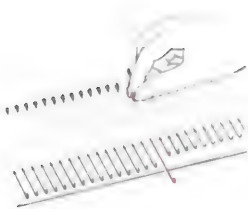

Sometimes more than 1 end needles is selected to D position. In this case, bring the needles back to B position by hand.

## DOUBLE LENGTH PATTERN

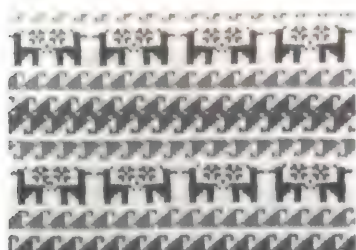

Normal pattern

Card No 9p

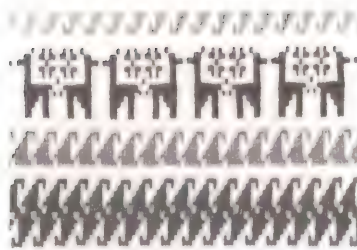

Double Length Pattern

Card No 9p

1) Thread the yarn tension unit as shown in the picture below

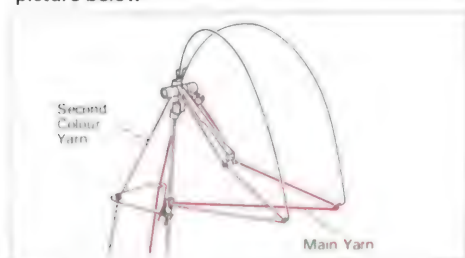

2) **STEP 2** Knit several rows of stocking stitch. Knit carriage at the right. Set the punchcard and the card lever at • mark

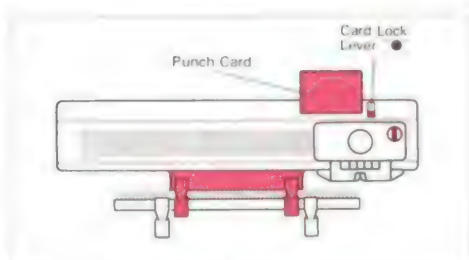

3) **STEP 2** Set change knob to KC and move knit carriage from right to left. Needles are selected

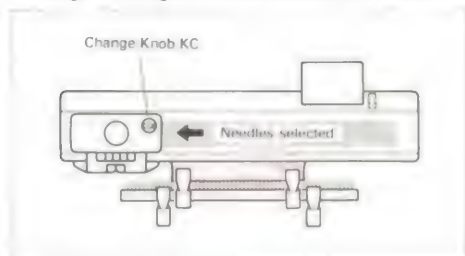

4) **STEP 3** Push the upper MC button

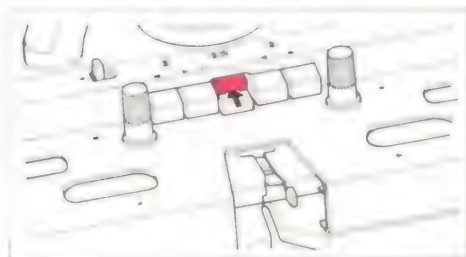

5) Set the card lock lever at the V mark

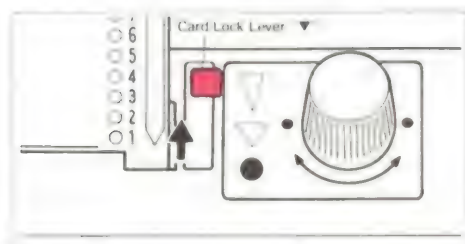

6) Thread 2nd colour yarn into yarn feeder B

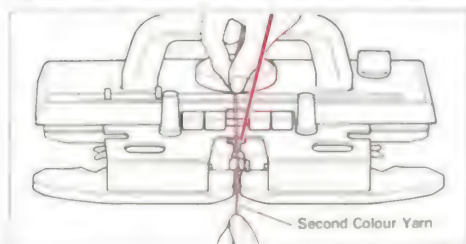

7) Operate the knit carriage whilst holding the yarn end with your left hand. Re-hang claw weights every few cms

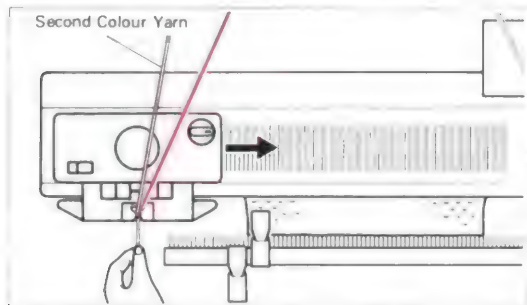

\* The punch card is rotated only when the knit carriage moves from left to right

### KNITTING A MIXTURE OF NORMAL & DOUBLE LENGTH PATTERNS

In the same way as when using double length patterns, push the knit carriage to the right and select needles.

When the asterisk (\*) mark appears at the start line on the left side of the punchcard, change the setting of the card lock lever from ▽ or ▼ accordingly and continue knitting.

**Always ensure that the knit carriage is at the left when changing the card lock lever.**



# FAIRISLE MOTIF PATTERN



Card No 10p

## CONNECT THE MOTIF KNITTING CAMS L & R

Join the ends of the cams and push until you hear a click.

Pull apart to disconnect

Motif knitting camms cannot be used individually

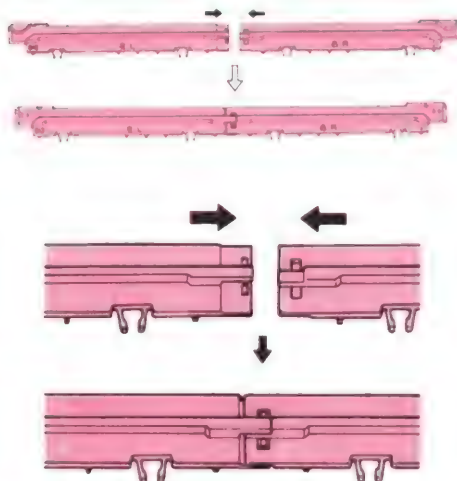

## PREPARATION

Before you begin to knit a single motif, take a small amount of the main yarn (background yarn) and separate it (see picture opposite) to make two small balls of yarn.

If you have a much finer yarn in the same colour, it is possible to use this instead.



1) Thread the yarn tension unit as shown in the picture. Thread the second colour yarn through the sub take-up spring (as shown)

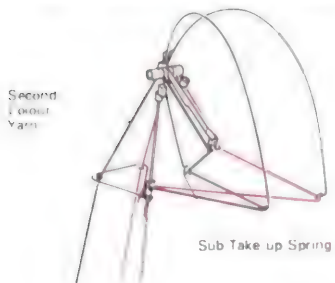

2) **STEP 1** Knit several rows of plain knitting and leave knit carriage on the left. Set the punch card and the card lock lever at the • mark.

Hang the claw weights

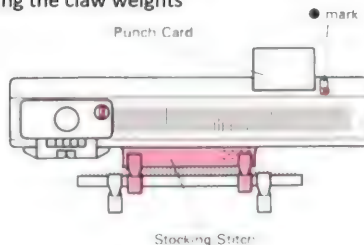

3) Place the motif cams beginning with the needle marked 

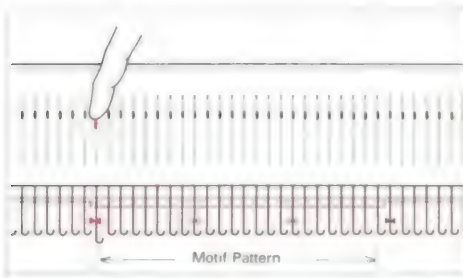

5) Push the cams back as far as they go and set them in - parallel with the rear rail. Make sure you put them in correctly.

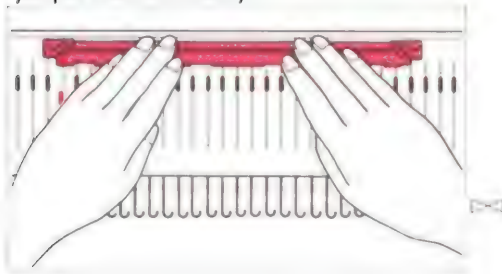

7) **STEP 3** Push the upper MC button

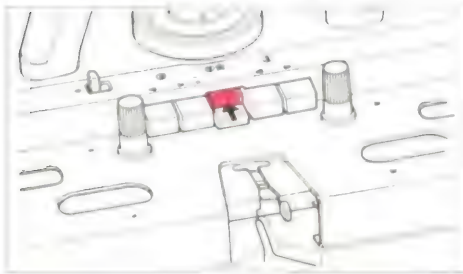

4) Place the motif knitting cams on the needle bed by matching the  mark on the rear rail and the cams



6) **STEP 2** Set the change knob to the SM position and move the knit carriage from left to right. The needles are selected.

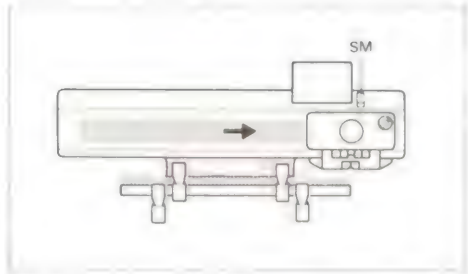

8) **STEP 4** Set the card lock lever at the  mark. Thread the 2nd yarn into feeder B and operate knit carriage - whilst holding yarn end lightly.

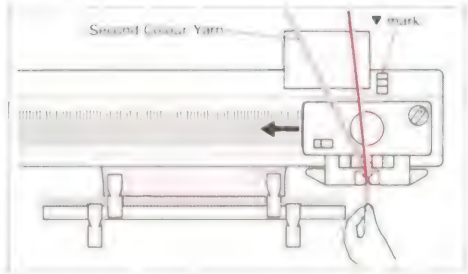

9) Make sure the 2nd colour yarn comes under the cavity of the sinker plate

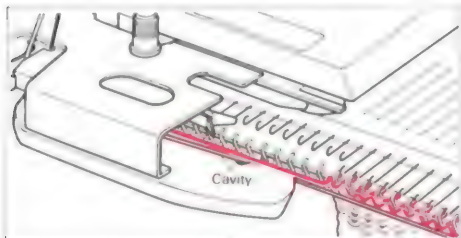

\* Pull the yarn up if there is any slackness

10) Bring the adjacent needle to those selected for the motif (on the knit carriage side) forward to D position and place separate single strand of yarn, into the hook. Then push the needle to D position.

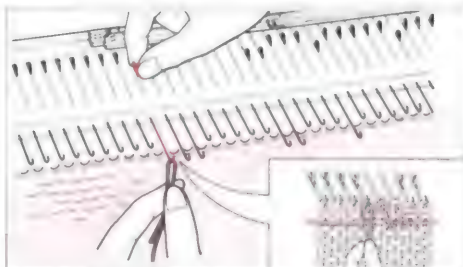
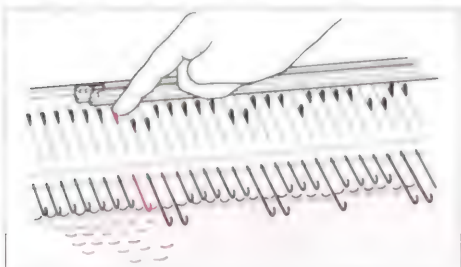

11) Move the knit carriage to right whilst holding the single strand yarn lightly with your hand.

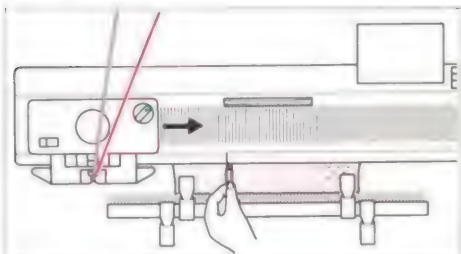

12) Work a 2nd yarn in the same way as the other side - then operate the knit carriage.

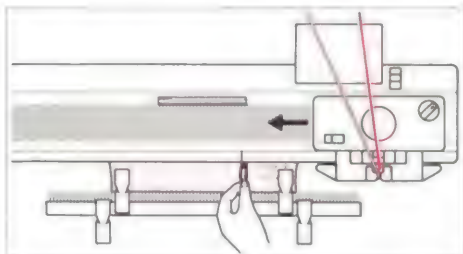

13) Hook the separate yarn every row as above - on both sides of the work. This avoids small holes.

**WHERE THE KNIT CARRIAGE IS ON THE LEFT SIDE ...**



**WHERE THE KNIT CARRIAGE IS ON THE RIGHT SIDE ...**



**14) Change the 2nd colour yarn in feeder B to the 3rd colour when the asterisk on the left side of the punch card - appears at the punchcard's start line**

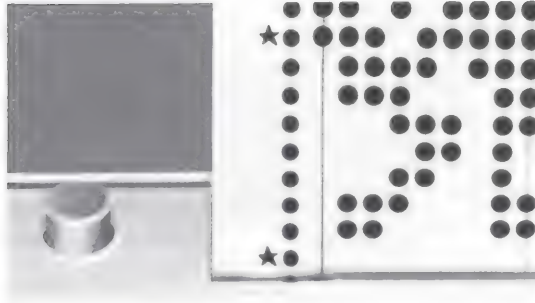

# THREAD LACE PATTERN (You can use the Card No. 1p, 11p, 12p, 13p, 14p, 15p)

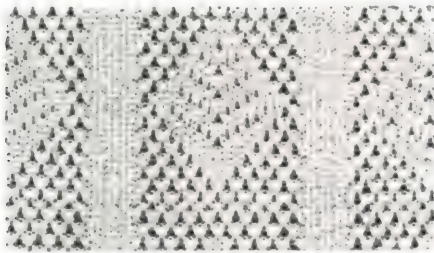

Card No 15p

\*This pattern is obtained by using a combination of thick yarn and a very fine yarn (thread).

1) Thread yarn tension unit as shown in the picture.

Adjusts the corresponding tension discs for the very fine yarn.

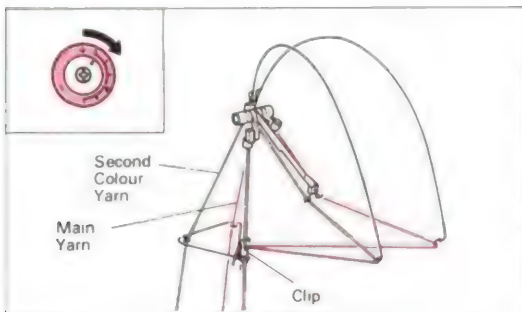

2) Release the end needle selection mechanism. Refer to Page 42.

If both end needles have selected - bring them back to B position.

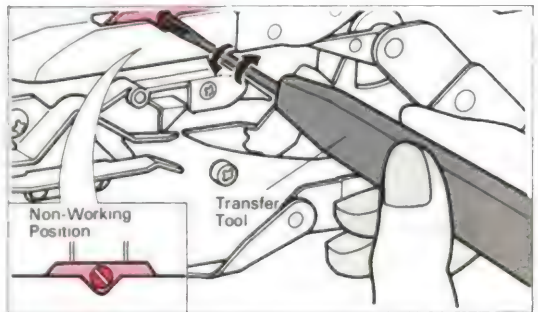

3) STEP 1 After knitting several rows of stocking stitch, place the carriage at the left. Insert the card and set the card lock lever at the • mark. Hang Claw weights

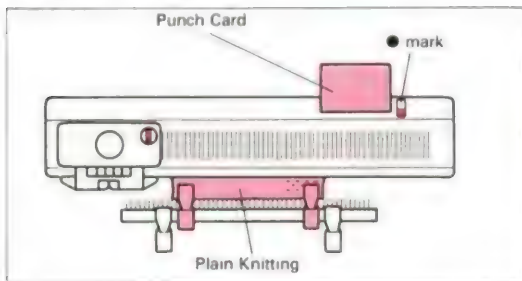

4) STEP 2 Set the change knob to the KC position and move the K Carriage from left to right. The needles are selected.

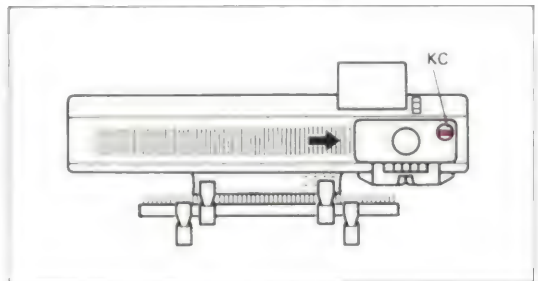

5) STEP 3 Push the MC buttons (upper & lower) at the same time

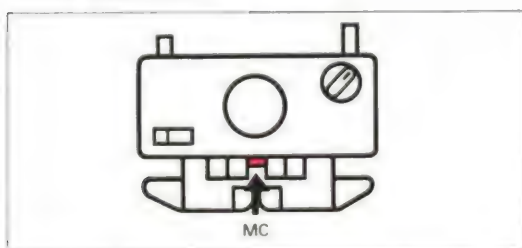

6) STEP 4 Set the card lock lever at ▼ mark

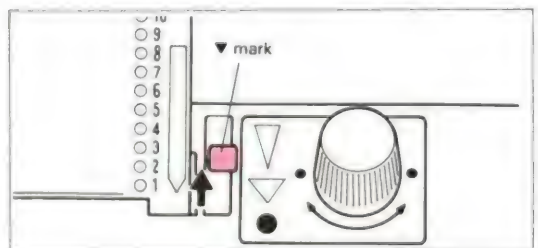

7) Thread the 2nd yarn colour into feeder B (without opening the yarn feeder lever.)

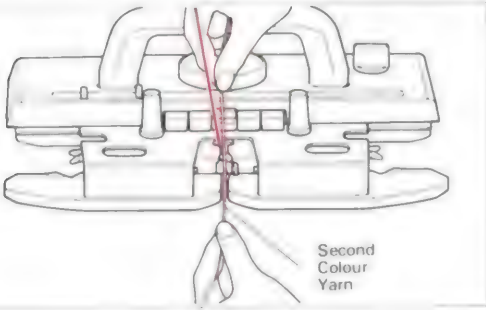

8) Operate the knit carriage whilst holding the yarn end with your left hand

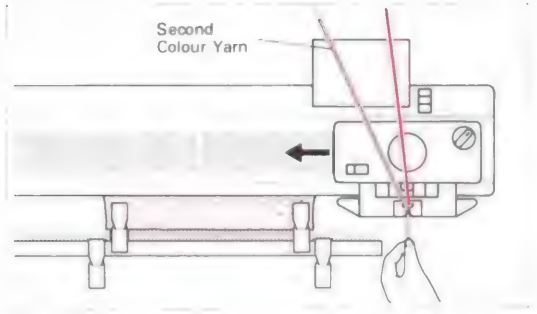

## THREAD LACE MOTIF PATTERN

You can also work motif patterns in thread lace pattern

Refer to the explanation of Fairisle Motif Pattern section and place the motif cams on the needle bed

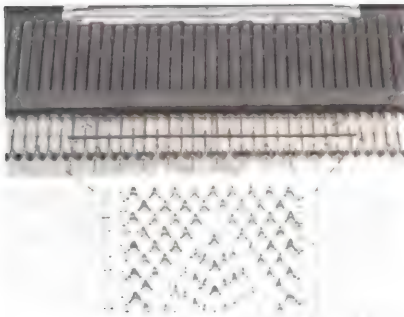

Card No. 15p

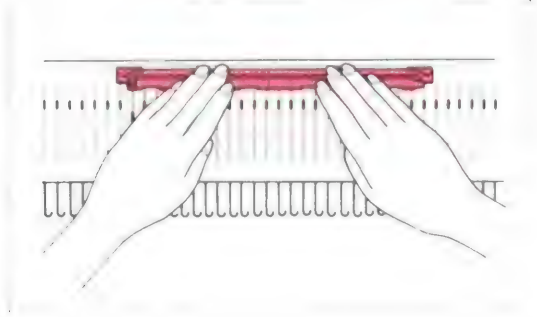

### NOTE

**Two needles in D position side by side is the limit for a successful thread lace pattern**



# PLATING YARN KNITTING

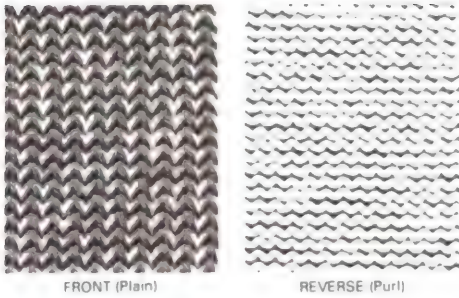

With the plating yarn feeder, it is possible to use two yarns to knit a reversible fabric with different colours on the front and back.

The main yarn will appear on the front (plain side) of the fabric and the plating yarn will appear on the (purl) reverse side of the fabric.

1) Thread the yarn as shown in the figure

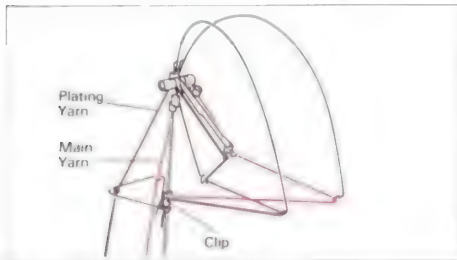

2) Knit several rows of stocking stitch and place the knit carriage on the right.  
Hang claw weights

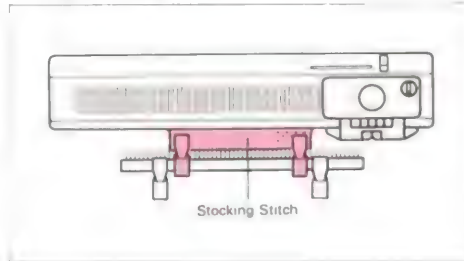

3) Move the knit carriage past the gate pegs

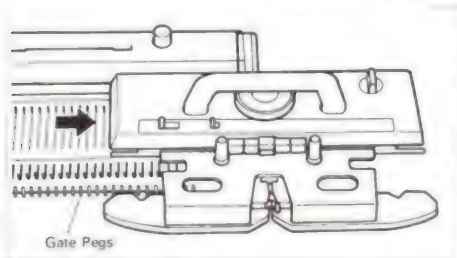

4) Pass the plating yarn behind the main yarn

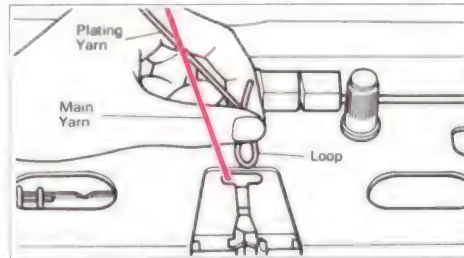

5) Thread the plating yarn in the plating yarn feeder. Use the latch tool to pull down the yarn

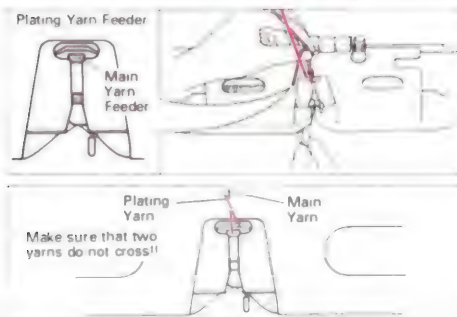

6) Operate the knit carriage while holding the end of the yarn, with your left hand

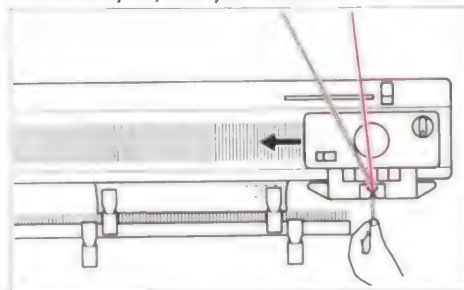

## TUCK STITCH PLATING YARN KNITTING

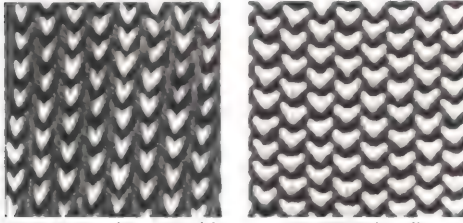

FRONT Stocking Stitch)

REVERSE (Purl)

Card No 1p

Using the punch card for tuck stitch patterns along with the plating method, you can produce plated tuck stitch patterns.

Preparation and operation are the same as when knitting tuck stitch and plating singly.

### HOW TO CANCEL THE WORKING OF END NEEDLE SELECTION MECHANISM

When knitting thread or open lace pattern with punchcards - some needles remain in A position. You will need to cancel the end needle selection mechanism on both sides of the knit carriage.

- 1) Set the change knob to KC
- 2) Remove knit carriage and turn it over
- 3) Set both end needle selection cams to non-working position.

**A** .Insert the tip of a transfer tool into the cam slot and turn. (see pics below)

**B** .Turn the transfer tool tip in the direction of the arrow.

After finishing the open or thread lace stitch pattern - REMEMBER TO RETURN THE END STITCH SELECTION CAMS BACK TO WORKING POSITION.

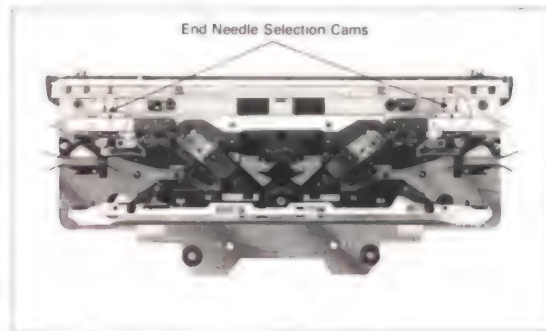
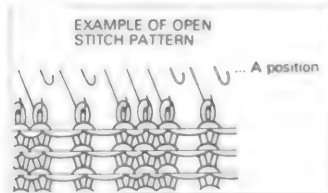

#### SETTING CAMS TO NON-WORKING POSITION

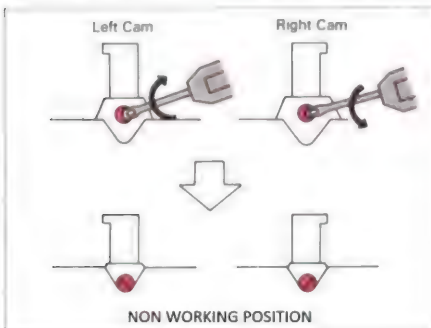

#### RETURNING CAMS TO WORKING POSITION

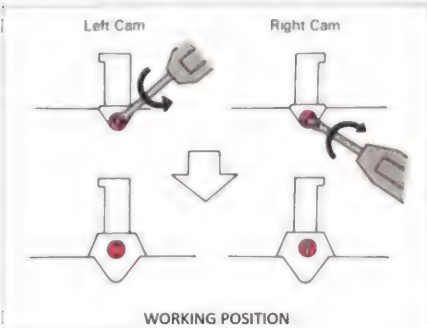

## 6. REPLACING THE KNITTING MACHINE IN THE CARRYING CASE

1) Join the cast on comb and set it as shown in the picture. Then, fix it with the holding springs

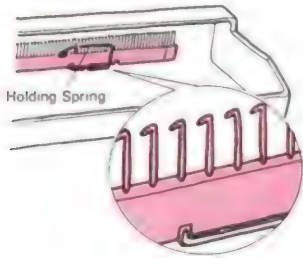

2) Remove the wax ring



3) Fold down the Front Guide Arm



4) Wind and fix the take up spring to the rod as shown in the picture



Fold down



5) Put the Sub Take up Spring on the rod

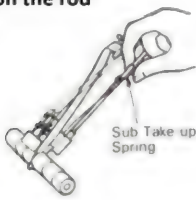

6) Fold down the rear yarn guide

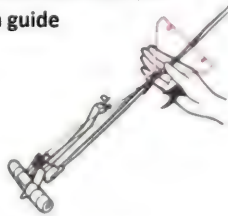

7) Set the yarn tension unit in the case



8) Set the row counter onto the two studs in the carrying case and push it away from you

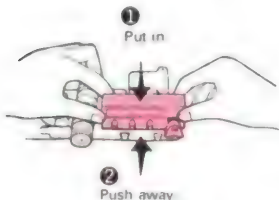

9) Fix the wheel brush

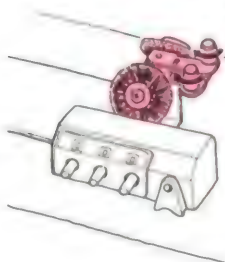

10) Remove the table clamps and return to the accessory box

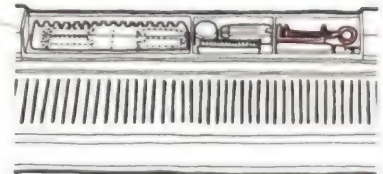

11. Close accessory box lid

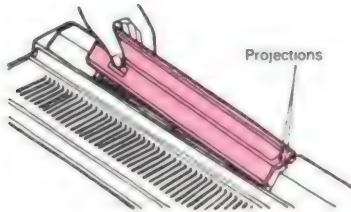

12. Loosen the thumb screws on the carriage and remove the sinker plate

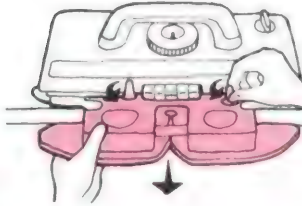

13. Put the sinker plate in the case as shown and close fixing spring

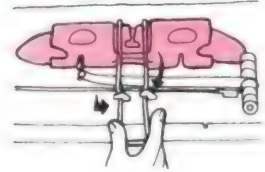

14. Insert the carriage lock in the hole at the left end of needle bed. With carriage at the left, fix the cut out end of carriage lock - under the LH carriage thumb screw and tighten.

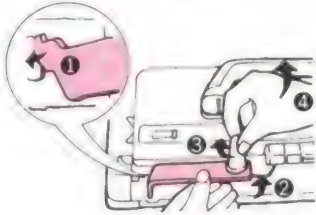

15. Hold the lid and close it over the needlebed. Lock both catches, either side of the handle

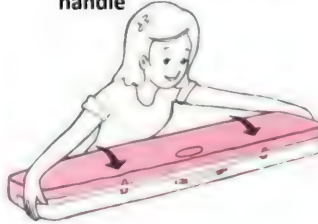

## IN STORED CONDITION



# USING THE KNIT LEADER

## HOW TO SET UP YOUR KNIT LEADER

**1. Take the Knitleader out of the case and remove both setting plates.**

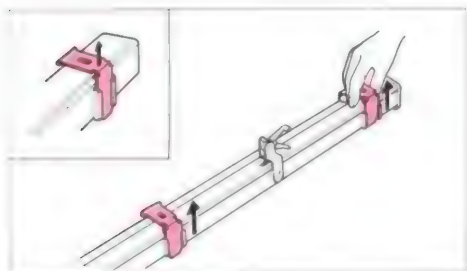

**2. Insert a setting plates into each setting plate holder**

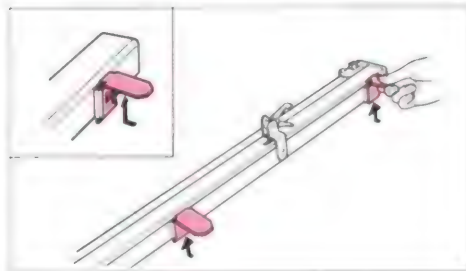

**3. Put the setting plates into the slots at the back of the knitting machine (Refer to the KL116 instruction manual.)**

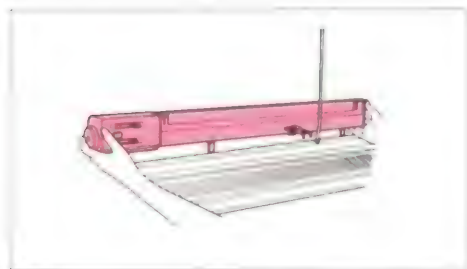

## TENSION AND KNITTING A TENSION SWATCH

The size of the stitch is determined by the tension setting on the carriage dial, yarn thickness, yarn brand and fibre content. To knit a garment to the correct size of your pattern, you need to know the size of the stitch. Before you start knitting, you should make a sample tension swatch and from it - measure the length of 30 rows and the width of 20 stitches.

### Knitting a Tension Swatch:

You must knit and measure a tension swatch each time you begin a garment, irrespective of whether or not you intend to use the Knitleader.

1. Set the row counter number to 000 and set the row counter tripper on the Knitleader to working position.

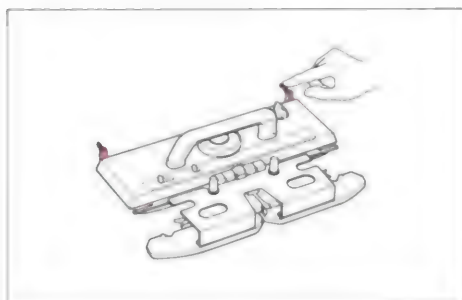

**2. Bring forward 40 needles (20 needles either side of the '0' mark) to B position and knit 10 rows in main yarn**



**3. Remove the main yarn and knit 2 rows with contrast colour yarn.**

**Row counter reads 012**



**4. Re-thread the main yarn and knit 15 rows.**

**Row counter reads 027**

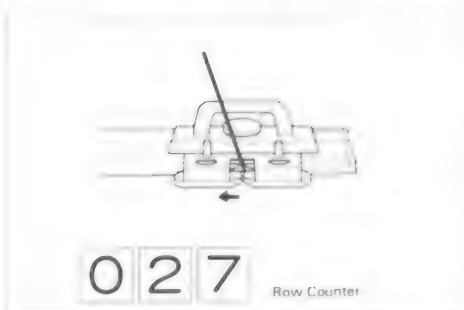

**5. Bring forward to E position - both 11th needle on either side of '0'.**

**Hook a short piece of contrast yarn onto the two needles as markers.**

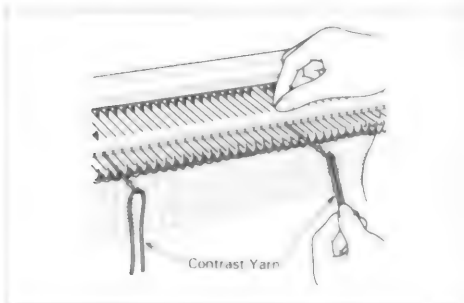

6. Knit 15 rows again in main yarn.

Row counter reads 042

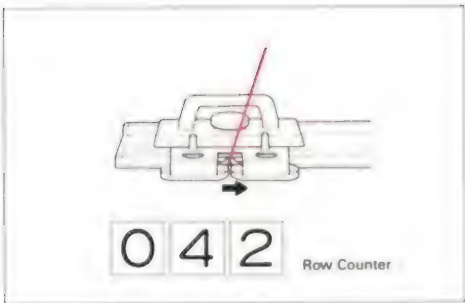

7. Remove the main yarn and knit 2 rows with contrast yarn.

Row counter reads 044

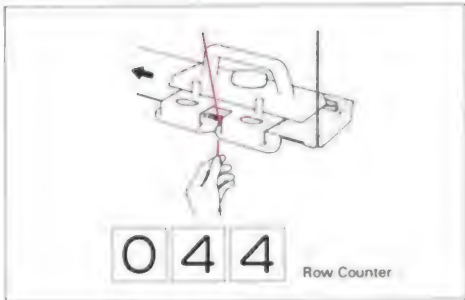

8. Re-thread the main yarn and knit 10 rows.

Row counter reads 054.

9. Remove the swatch from the knitting.

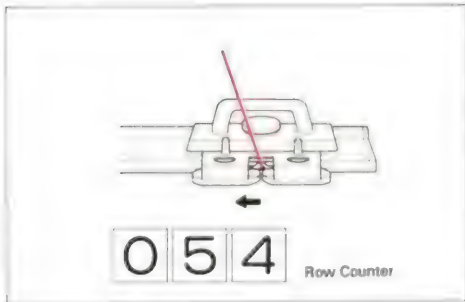

### HOW TO MEASURE THE SWATCH

A. Measure the height of 30 rows between knitted contrast colours.

B. Measure the width of 20 stitches between the two contrast colour markers.

C. Select the correct stitch scale (see KL116 user manual).



# MAKING GARMENTS

## (1) HOW TO USE THE TRANSFER TOOL

Use the transfer tools when you need to increase, decrease or transfer stitches.

How to hold the transfer tool

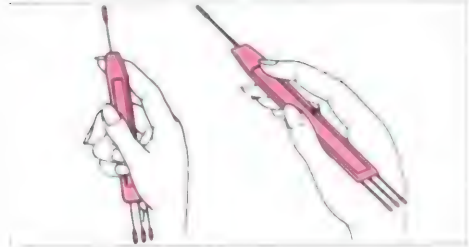

### HOW TO TRANSFER A STITCH WITH THE HAND TOOL

1. Using the eye of the transfer tool, hook onto the needle and pull it toward you

2. Push back the transfer tool and the needle until the stitch slips off the needle and onto the transfer tool.

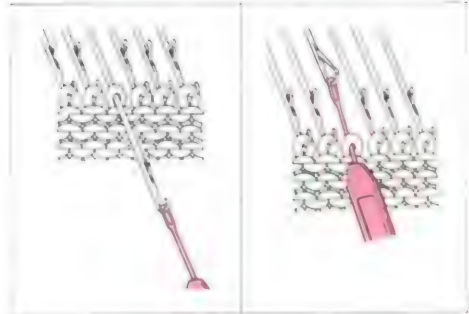

3. Place the transfer tool (with stitch on it) into the hook of the adjacent needle. Tilt the hand tool up from the back and allow the stitch to slip onto the needle hook.

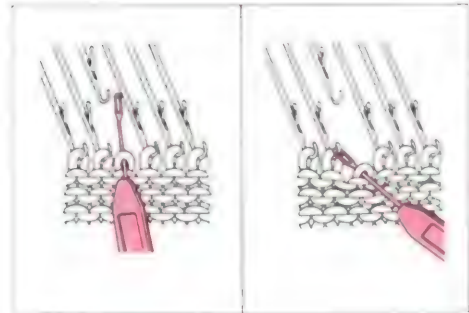

## (2) HOW TO USE THE LATCH TOOL

The latch tool is mostly used for hand ribbing and picking up dropped stitches.

How to hold the latchet tool



## Making Rib by Hand

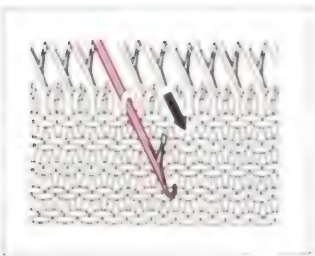

1) Bring one needle forward to position E by hand and return it to position A

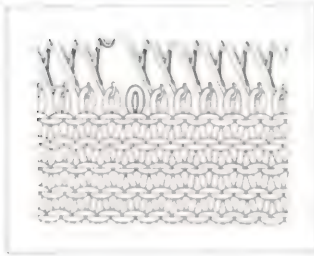

2) One stitch has been dropped from the hook of the needle

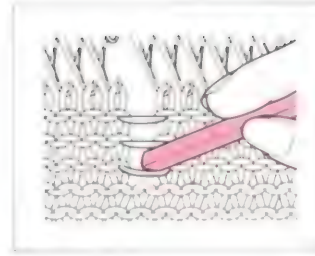

3) Using the tip of your latch tool, unravel your knitting

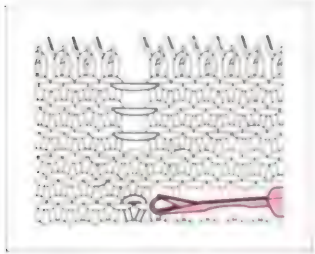

4) Drop the stitch for a few rows in the line you want to rib, to the place you want to start the ribbing. Place the latch hook in the stitch you want to start with

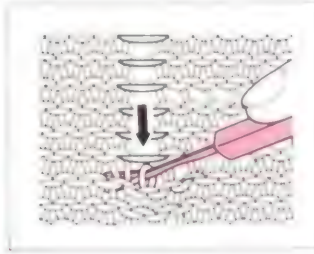

Depress the latch tool to drop the last few stitches leaving the start stitch on the stem of the latch tool.

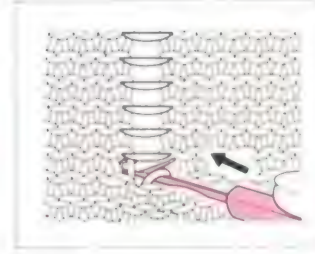

6) Hold the knitting firmly. Push the latch tool away from you until the stitch on the latch tool is behind the latch.

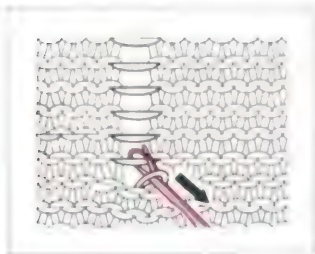

7) Catch the next parallel thread with the hook of the latch tool and pull the latch tool toward you.

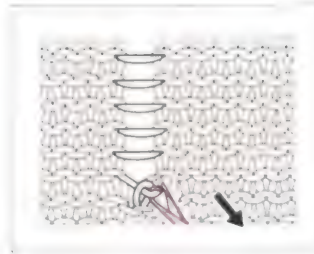

8) The latch will close with the new yarn in the hook. Pull this yarn through the stem of the latch tool to form a new stitch. Don't pull too hard.

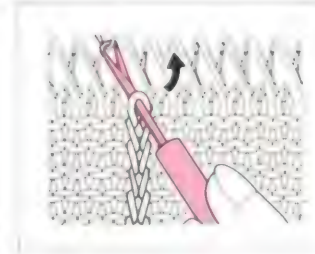

9) Repeat this until you reach the top and hook the last made stitch, onto the machine.

## (3) HOW TO INCREASE STITCHES

### 3-1. Increasing one stitch (simple method)

- 1) On the carriage side, push one edge needle from position A to E
- 2) Knit one row and the empty needle will pick up the yarn

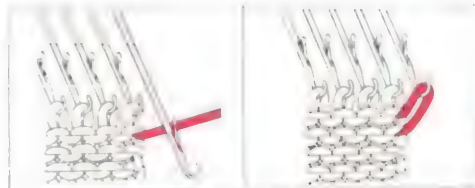

3) Knit another row and one new stitch will be formed



### 3-2. Increasing one stitch (fully fashioned method)

1) At the edge of knitting, use the transfer tool to move the very edge stitch out to adjacent empty needle. (This leaves an empty needle in between).

2) Pick up the loop below the empty needle as shown - using the transfer tool.

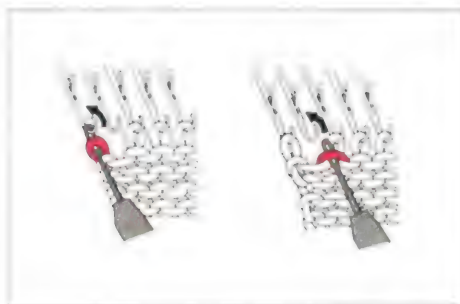

3) Lift the loop onto the empty needle hook with the transfer tool.



### 3-3. Increasing several stitches

1) On the carriage side, pull the needles to be increased, from A to E position



2) Wind the yarn loosely around the stem of each needle but - on the end needle - only pass the yarn *under* the needle



3) Knit one row. If the stitches don't knit smoothly - pull the needles holding the increased stitches to E position



#### (4) HOW TO DECREASE THE STITCHES

##### 4-1 Decreasing one stitch (Simple method)

- 1) Remove one stitch at the edge, onto the transfer tool.
- 2) Hook the transfer tool onto the inside adjacent needle and transfer the stitch to it.

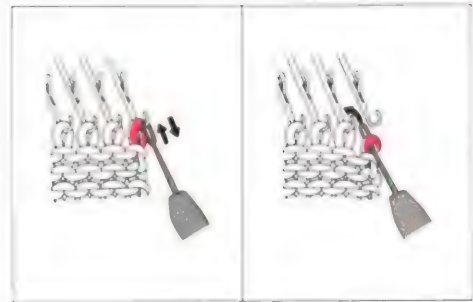

3) Return the empty needle to A position



2) Wind the yarn loosely around the stems of each needle but on the end needle only - pass the yarn *under* the needle

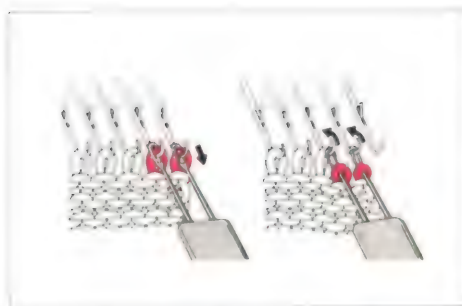

3) Knit one row. If the stitches don't knit smoothly, pull the increased needles out to E position

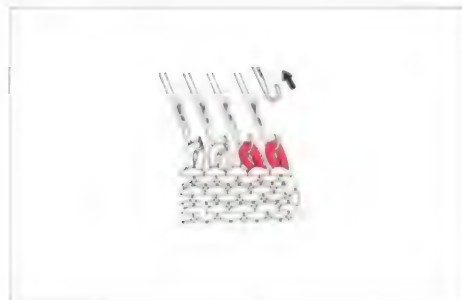

#### (4) HOW TO DECREASE THE STITCHES

##### 4-1 Decreasing one stitch (Simple method)

- 1) Remove one stitch at the edge, onto the transfer tool
- 2) Hook the transfer tool onto the inside adjacent needle and transfer the stitch

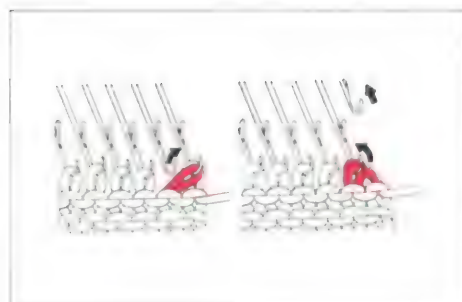

3) Return the empty needle to A position

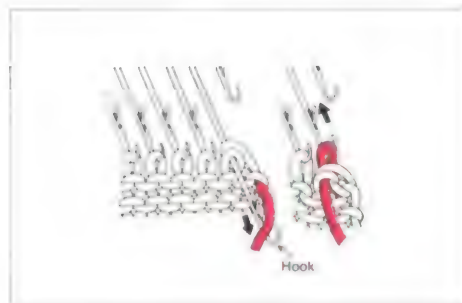

4) Repeat the process from step 1 to step 3.  
(the last stitch needs only step 1 and 2)

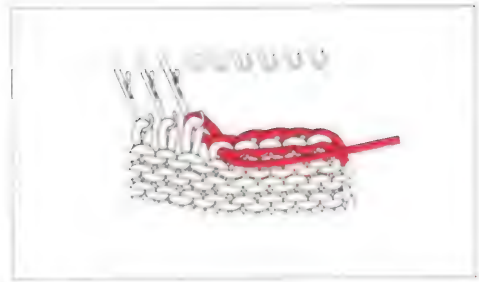

## (5) PARTIAL KNITTING

### 5-1 Decreasing stitches

When knitting a decreased section of your garment e.g. shoulder or neck opening etc., set the holding cam lever of the knit carriage to position H



1) On the opposite side of the carriage bring forward the needles to be decreased - to E position

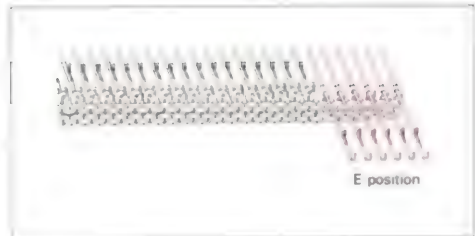

2) Knit one row. The needles in B position are knitted and in position E the yarn will simply pass over the needles.

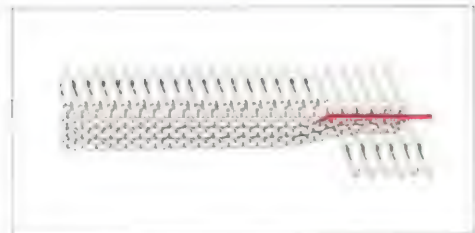

3) Pass the yarn under the stem of the first needle in E position, as shown

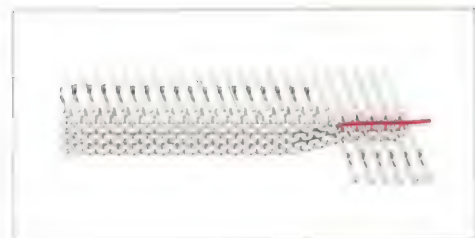

4) Knit one row

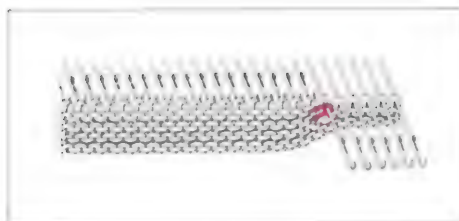

5) Continually move the needles to be decreased to E Position and repeat the process from step 1 to step 4.

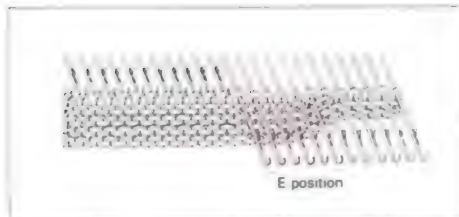

### 5-2 Increasing stitches

When knitting an increased part of your garment e.g. the hemline of a skirt - set the holding cam lever of the knit carriage to position H



1) On the opposite side of the carriage, bring the needles not to be knitted - forward - into E position.

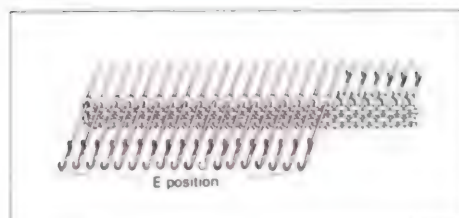

2) Knit one row and the needles in B position are knitted but the yarn passes over those in E position

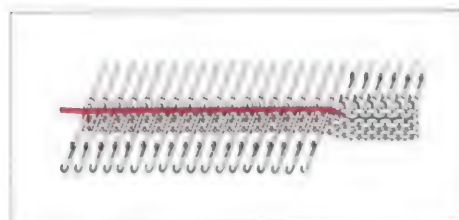

3) Pass the yarn under the stem of the first needles in E position

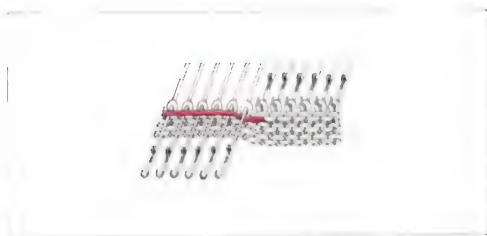

4) Knit one row

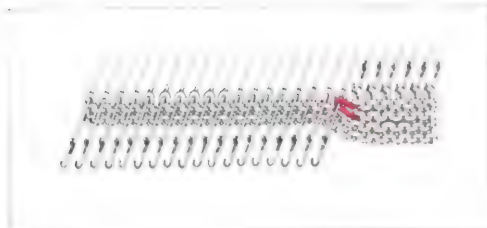

5) Manually return the needles to be increased from position E to D

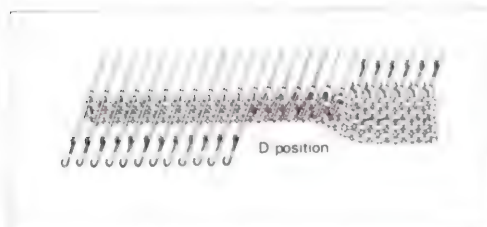

6) Knit one row and the needles which you brought to D position are knitted



7) Repeat the process from step 3 to step 6

**FOR TUCK STITCH PATTERN**

If the end needle is selected to position D, pass the yarn over the hook before passing it under the stem of the next needle.

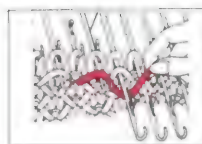

**FOR FAIRISLE AND WEAVING PATTERN**

Pass the second colour yarn or weaving yarn under the stem with main yarn.

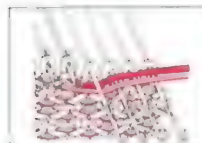

### (6) CABLE STITCH PATTERN

The cable stitch pattern is knitted by crossing the stitches using the transfer tool.  
The following example is knitted using 2 eye transfer tools. The cable is four stitches wide, flanked on either side with a purl stitch

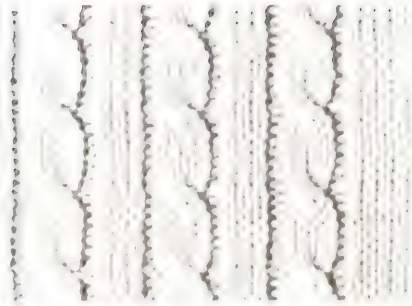

1) Knit several rows and drop both outside stitches on either side of the cable pattern stitches.

2) Transfer 3 stitches onto each 2 eyed Transfer Tool (See illustration)

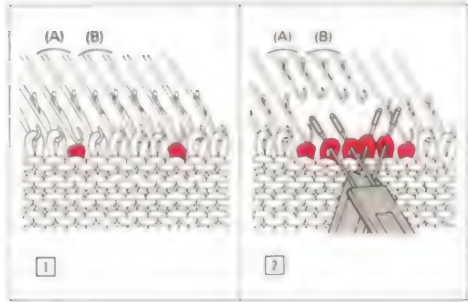

3) Transfer the stitches (A) to position (1)  
Transfer the stitches (B) to position (2)

4) Using the latch tool, pick up the stitches which you have dropped and allowed to ladder down in step 1 and latch them up to form purl stitches on the right side of the fabric.

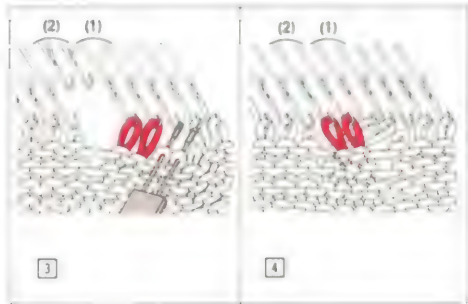

### (7) RIBBING STITCHES (1 x 1 rib)

The 1 x 1 rib is one plain and one purl stitch alternating along the row. It is waistbands, cuffs, collars etc.

Refer to page 48 (how to use the latchet tool).

Reform the purl stitch into a plain stitch on every other needles using the latch tool.

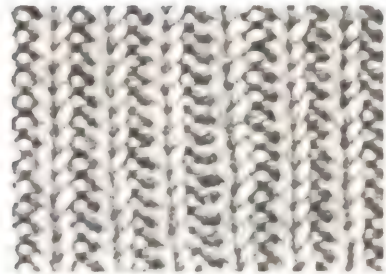

## (8) TUBE KNITTING

Tube knitting is a kind of skip stitch which makes a seamless tube



1) Place the knit carriage at the right of the machine and push the right or left part button. (Set the tension Dial at one number lower than the original tension)

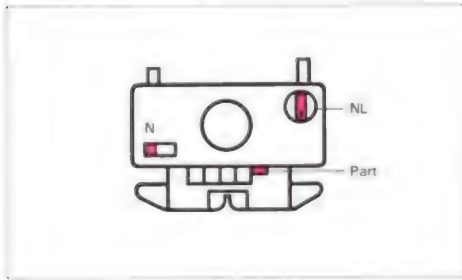

3) Pull down the baric with your left hand as you knit and operate the carriage

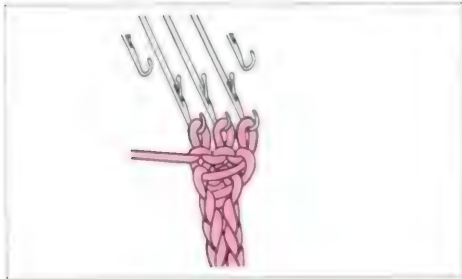

2) Cast on 3 or 4 needles by e-wrap method

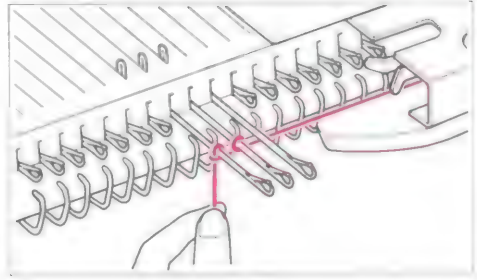

# USEFUL HINTS

## IF THE CARRIAGE SHOULD JAM WHEN WORKING STOCKING STITCH

1) Do not move the carriage by force. Take the yarn out of the yarn feeder and loosen the knobs to remove the sinker plate assembly. If the yarn has tangled in the rubber wheels, remove it.

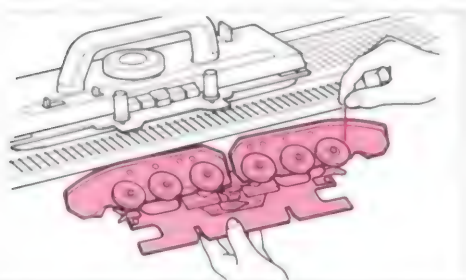

2) Set the carriage knob to position CR to release the knit carriage, then lift it toward you to remove it from the needlebed.

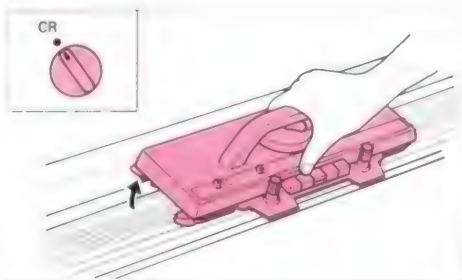

3) Return the change knob to the position NL. Screw the sinker plate back onto the knit carriage and place it back on the needlebed in its previous knitting direction.

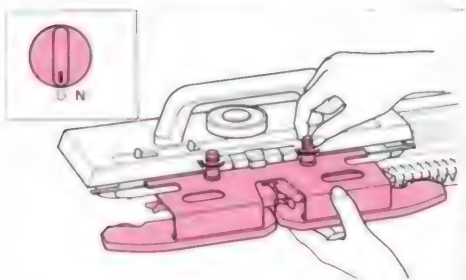

4) If stitches had slipped off when the carriage jammed, return them to their needles using the transfer tool and put the needles to B position.

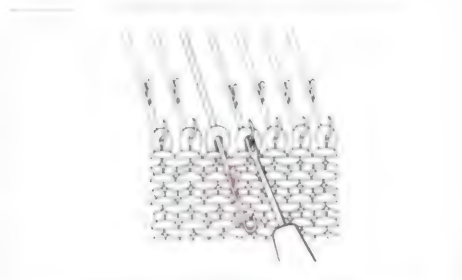

5) Unravel a row of knitting by pulling the yarn slightly sideways and upwards.

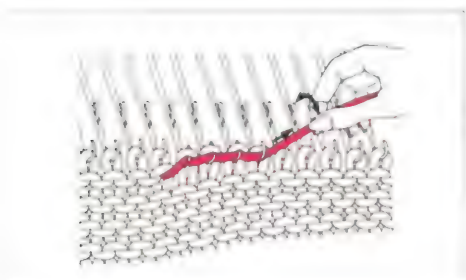

6) After unravelling the knitting, make sure that the stitches are all in the hooks of their needles. Take up any slack in the yarn. If the carriage is at the opposite end of the bed to the yarn end, press both part buttons and move it to the right side. Wind back the row counter if necessary, insert yarn in sinker and continue to knit.

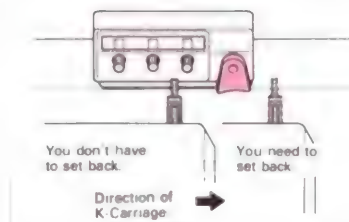

# PATTERN KNITTING

1) Set the card lock lever at the • mark

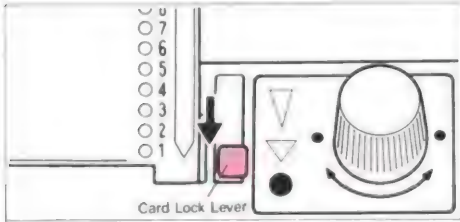

\* If there are some needles which have slipped back down the needlebed, push the card feeding button to bring them back up

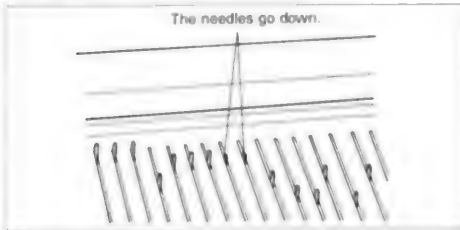

3) Refer to the explanation of stocking stitch, adjust the needles and unravel the knitting

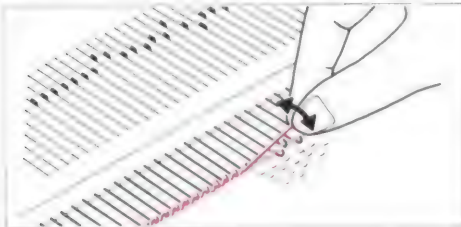

5) Wind back the punchcard to correspond with the number of rows you have unravelled



2) Take out the yarn and the sinker plate assembly then remove the knit carriage

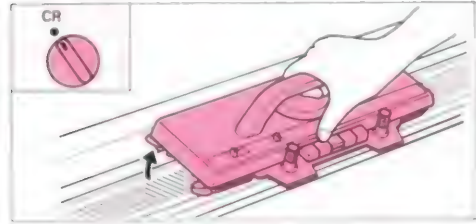

### IN CASE OF THREAD LACE PATTERN

You don't have to release the cam buttons in removing the knit carriage. If you should release them, push the buttons again after you remove the knit carriage without sliding it

4) Wind back the row counter if necessary

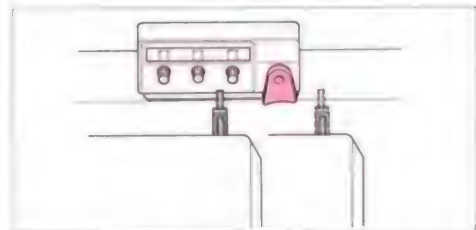

### IN CASE OF DOUBLE LENGTH PATTERN FEED BACK THE CARD AS THE FOLLOWING CHART

Number of (un)knitted row	Direction in which the carriage has been moved	
	←	→
1	Rewind the Punch card 0 step (s)	Rewind the Punch card 1 step (s)
2	1	1
3	2	2
4	3	3
5	2	2
6	1	1
7	3	4

6) Set the change knob to KC or SM position and place the carriage on the needle bed on the opposite side to the yarn end

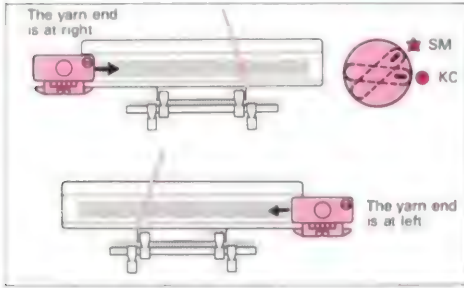

7) Push both part buttons and move the carriage to the same side as the yarn end. The needles are selected. Set the trippers to non-working position

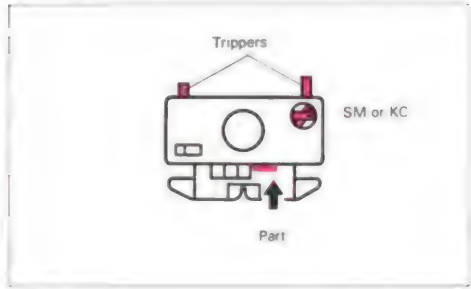

8) Set the card lock lever to the ▽ mark and set the carriage into the position of pattern knitting as before. Set trippers to working position and begin to knit.

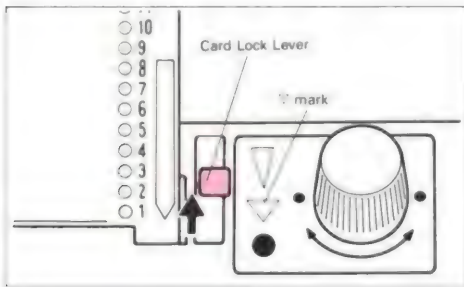

## REPLACING A NEEDLE

1) Push the sponge bar with the handle of the crochet hook.

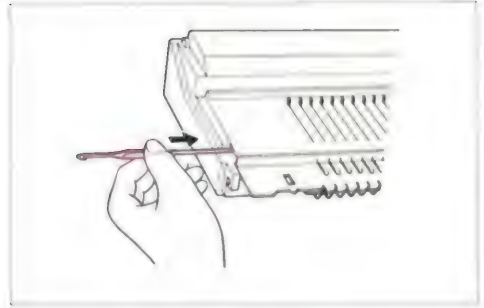

2) Draw the bar out by hand until the end of the bar passes the needle to be replaced.

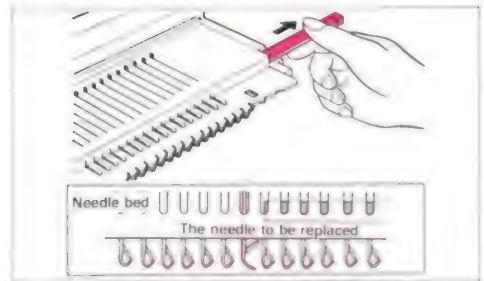

3) Push the needle forward to E position

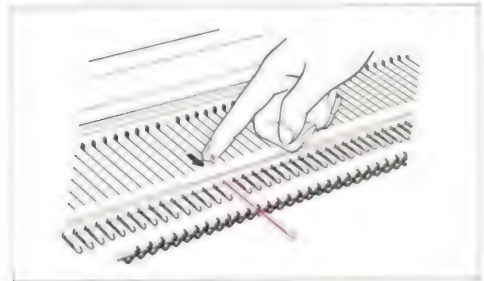

4) Push down the hook of the needle until you see the shank rising clear of the needle bed. Lift the needle out. **MAKE SURE THE NEEDLE'S LATCH HOOK IS CLOSED BEFORE REMOVING IT.**

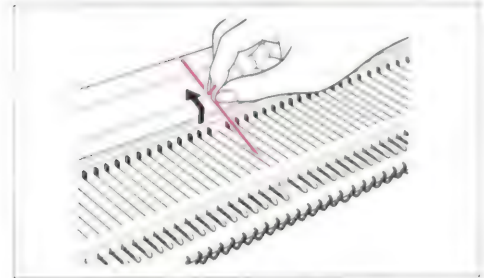

5) Fit the new a new needle into the needle bed at the same angle as it came out. **MAKE SURE THE LATCH IS OPEN BEFORE INSERTING IT INTO THE BED.**

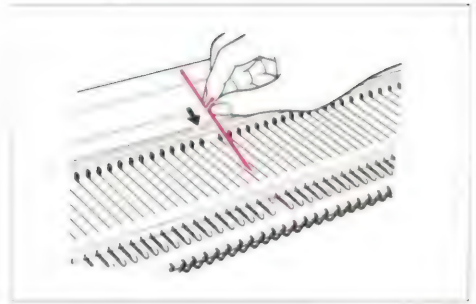

6) Push the needle back to A position

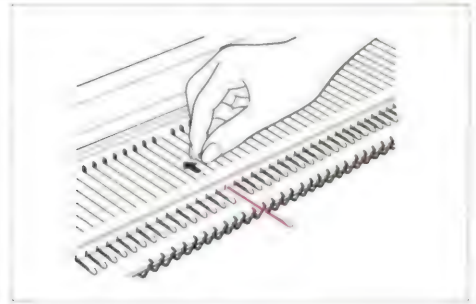

7) Push the sponge bar back into its channel and at the same time, depress all needle hooks with the straight edge of the 1 x 1 needle pusher.



## PICKING UP A DROPPED STITCH

Using the transfer tool pick up the stitch (the row below the dropped stitch) and make up into a new stitch, by hooking the loop into a new stitch, using the needle.

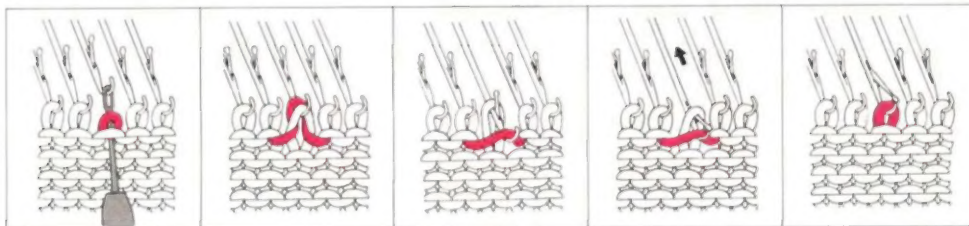

### Picking up a stitch that has dropped several rows

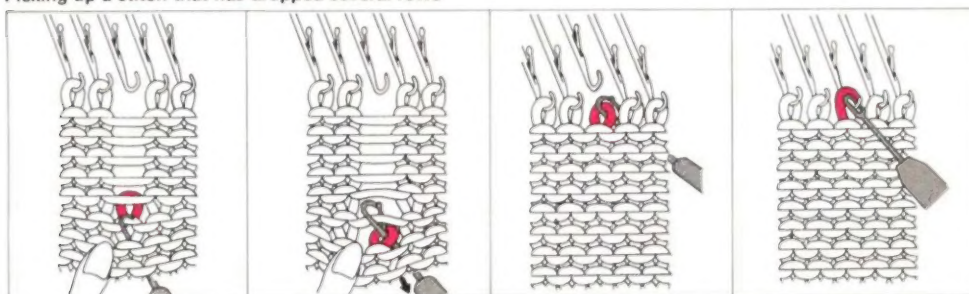

1) Using the latch tool from behind, hook up the bottom stitch and re-make the stitches, row by row

2) On the last row, transfer the stitch from the latch tool to the transfer tool and hook the new stitch onto the needle

## IF THE GATE PEGS CATCH THE YARN

If the yarn catches on the gate pegs, it is difficult to knit.

1) Place the latch tool with the hook facing you.

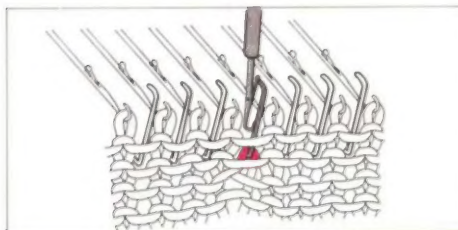
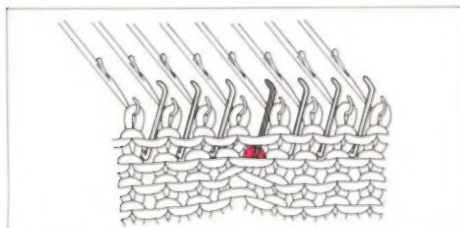

2) Hook the yarn caught on the gate pegs and lift it over the gate peg and release.

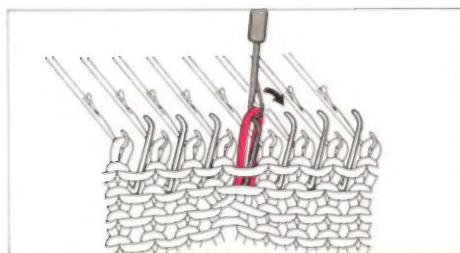

**How to check if the needles are selected correctly**

1) Set the projection of the card feeding knob at the □ mark on the panel without pushing it

2) Push the card feeding knob and turn it in the arrow direction for 180 degrees.

The card is then fed back for 7 rows and you can see the perforations of the pattern you are knitting

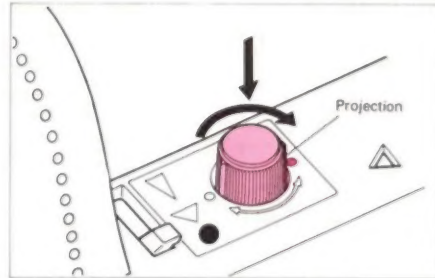
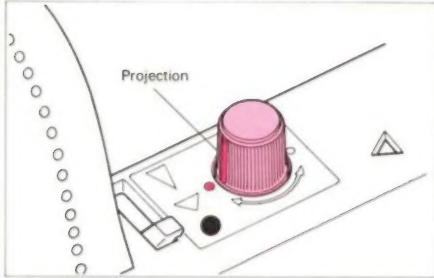

**Check following points if the needles are not selected correctly...**

Is the card set correctly?

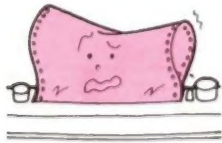

Are there any bent or broken needles?

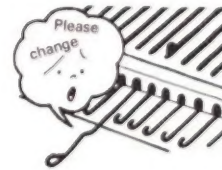

# MAINTENANCE

Cleaning and oiling is the key keeping your machine in good condition and for smooth knitting

\*Brush away any dust or lint on the needle position indicator

\*Wipe the following parts with an oiled cloth after the machine has been left standing for some time

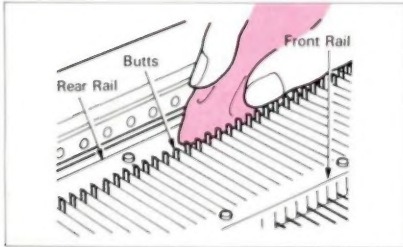
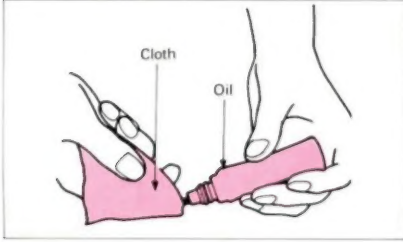

- Needle Bed
- Needle Butts
- Front & rear needle bed rails
- Underside of the carriage parts as highlighted below in red

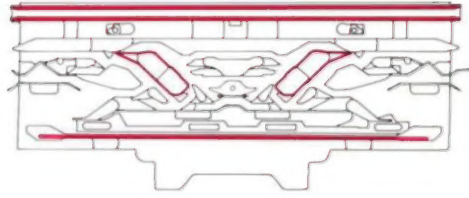

\* Do not put oil directly onto the machine

\* Wipe the plastic parts with soft cloth using a gentle neutral detergent solution

\* Do not use alcohol, benzine, thinners or petrol on the machine

\* Do not leave it near heat sources, direct sunlight or where excessive dust and moisture are present

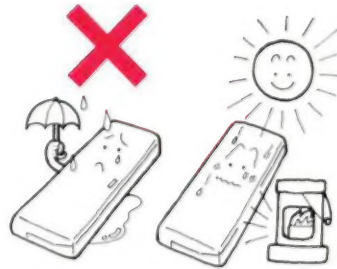

\* When you use the machine again - after it's been left for a long time - knit 20-30 rows with waste yarn to clean off any dirty oil.

