

brother.



**COMPUTERIZED
SEWING MACHINE**

COMPAL GALAXIE

Model 870

**OPERATION MANUAL &
SEWING GUIDE BOOK**

CAUTION

When leaving the sewing machine unattended, the main switch of the machine must be switched off or the plug must be removed from the socket-outlet.

When servicing the sewing machine, or when removing covers or changing lamps, the machine or the electrical set must be disconnected from the supply by removing the plug from the socket outlet.

SAFETY INSTRUCTIONS

1. Before plugging in your machine, make sure the electrical information on the machine data label conforms with the voltage of your power supply.
2. Disconnect the power line plug from socket outlet when changing needle, bulb, presser foot or when leaving machine unattended. This eliminates the possibility of starting the machine by accidentally pressing the foot controller.
3. Do not attempt to adjust the motor belt or inner components. Contact your nearest service center.

WELCOME
TO THE WONDERFUL WORLD OF SEWING

In the following pages, you will see how this wonderful Brother sewing machine will help you to enjoy sewing beautifully for your home and family.

A variety of stitches are possible with this sewing machine along with your basic straight stitching needs and you will find its quiet, smooth, efficient performance in the true tradition of precision engineering.

The versatility of your **brother** sewing machine will give you full play as you work with various kinds of material and you can let your imagination work along with your **brother** sewing machine to produce beautifully sewn garments.

You will enjoy a lifetime of sewing pleasure with your **brother** sewing machine and we suggest that you follow this basic booklet carefully to ensure maximum enjoyment.

** To ensure that you are always provided with the most modern sewing capabilities, the manufacturer reserves the right to change the appearance, design or accessories of this machine when considered necessary.*

CONTENTS

Operation Manual

OUTLINE OF THE MACHINE	2
PRINCIPAL PARTS	3
SETTING UP THE MACHINE	5
BOBBIN THREADING	7
UPPER THREADING	9
DRAWING OUT LOWER THREAD ...	11
TENSION ADJUSTMENT	12
CHANGING NEEDLE	13
Needle	13
Presser foot	13
Accessories	14
Attaching zipper foot	14
SIDE-CUTTER	15
OTHER FUNCTIONS	17
Drop feed lever	17
Pressure control lever	17
Double lift presser foot lifter	17
Thread cutter	17
How to change the bulb	18
Twin needle	18
MAINTENANCE & CHECK POINT....	19
SEWING CHART	21

Sewing Guide Book (I)

For daily applications

Contents	23
----------------	----

Sewing Guide Book (II)

Enjoy 100 stitch and limitless self-create

Memory mode	59
Program mode	64

OUTLINE OF THE MACHINE

This electronic sewing machine has following epoch making features in addition to ordinary machine. It is recommended you find out such benefits item by item in this booklet.

LIMITLESS PATTERN VARIETY

There are 3 modes for limitless pattern selection.

Utility Mode 20 basic stitches for daily use. (Page 24)

Memory Mode . . . 100 stitches including figures and monogram. (Page 59)

Program Mode .. self-create limitless stitches for your own taste. (Page 64)

EASY SEWING

To have more easy operation, there are

Auto-needle-threading (Page 9)

Careful-free stitch length/stitch width auto-setting (Page 6)

Both-way speed control by foot controller and finger-touch control (Page 6)

PROFESSIONAL WAY

Cloth-cutting device (Page 29)

One-step automatic Buttonhole (Page 33)

Free arm/flat bed conversion (Page 3)

Wide application with various accessories (Page 13)

VOICE MESSAGE

"Please lower presser foot lever." (Page 6)

"Reverse stitch cannot be obtained using this pattern." (Page 6)

"Please use a foot controller." (Page 6)

"Please lower blue lever." (Page 36)

"Please raise blue lever." (Page 36)

"Please change position of red knob to left to lower feed dog." (Page 40)

"Please change position of red knob to raise feed dog." (Page 40)

"Please check instruction book." (Page 63, 70)

"Memory Capacity full. Please check instruction book." (Page 63, 70)

"This pattern combination is not acceptable. Refer to instruction book." (Page 63)

CHECK BUZZER

※ Correct switching



There goes ONE buzzer

※ Incorrect switching



There goes TWO buzzers
and VOICE MESSAGE runs

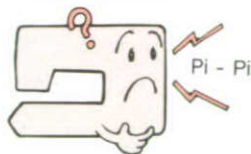
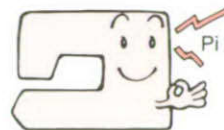

PRINCIPAL PARTS

- ① Handle
- ② Upper tension control dial
- ③ Thread guide
- ④ Thread take-up lever
- ⑤ Joint key
- ⑥ Input keys (Ten keys)
- ⑦ Needle position button
- ⑧ Reverse button
- ⑨ Start/stop button
- ⑩ BLUE buttonhole lever
- ⑪ Needle thread guide bar
- ⑫ Presser foot
- ⑬ Feed dog
- ⑭ Extension table
- ⑮ Thread cutter
- ⑯ Needle threader
- ⑰ Pressure Regulating lever
- ⑱ Presser foot lever
- ⑲ Shuttle cover
- ⑳ Accessory compartment
- ㉑ RED feed knob

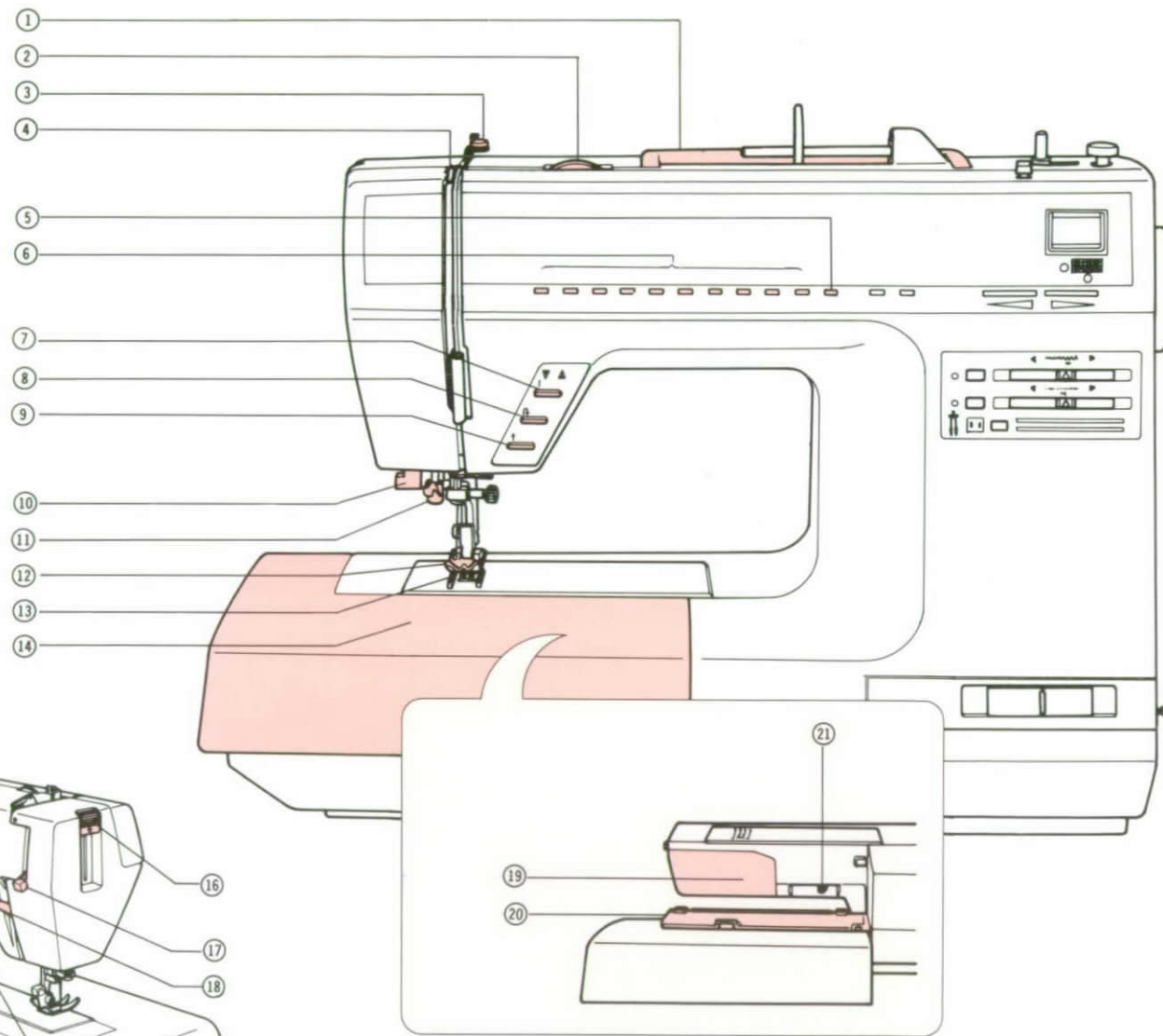
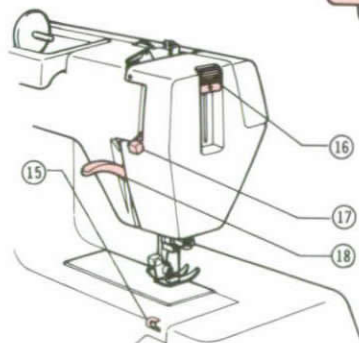

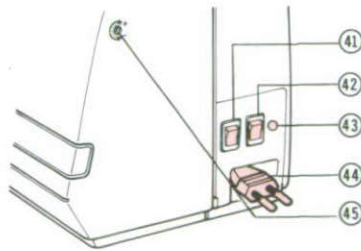
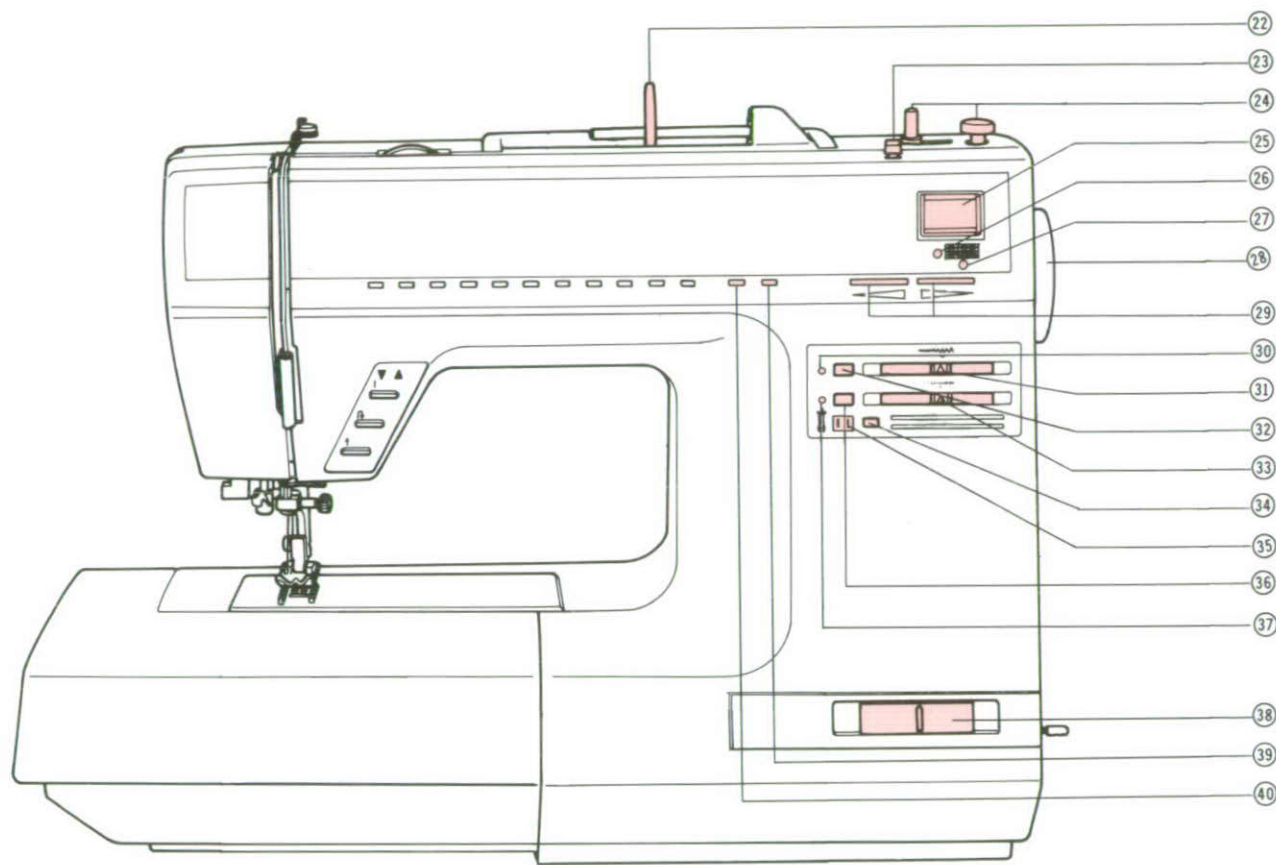

- ②2 Spool holder
- ②3 Pattern display change lever
- ②4 Bobbin winder
- ②5 Digital display window
- ②6 Vertical program lamp
- ②7 Horizontal program lamp
- ②8 Balance wheel
- ②9 Pattern selection button
- ③0 LED for manual stitch width
- ③1 Manual stitch width control lever
- ③2 Manual stitch width release button
- ③3 Manual stitch length control lever
- ③4 Twin needle switch
- ③5 LED for twin needle
- ③6 Manual stitch length release button
- ③7 LED for manual stitch length
- ③8 Speed control lever
- ③9 Program END key
- ④0 Program START key
- ④1 Main power switch
- ④2 Lamp switch
- ④3 Junction for foot controller
- ④4 Power plug
- ④5 Stitch length fine adjustment dial

SETTING UP THE MACHINE

Let's Start

1 Power supply cord

Pull the power supply cord from the cord reel housing.

NOTE: *Do not pull the cord to such an extent that red marking appears.

*To enroll the cord into housing, slightly pull the cord and release.

The cord will automatically roll away.

*When using the foot controller, connect the controller jack into the junction.

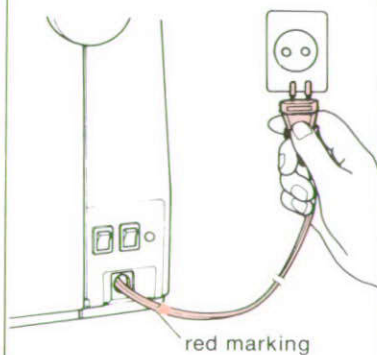

2 Power supply & lamp switches

To switch on sew light, turn on power supply switch first. (see page 18 for replacing bulb)

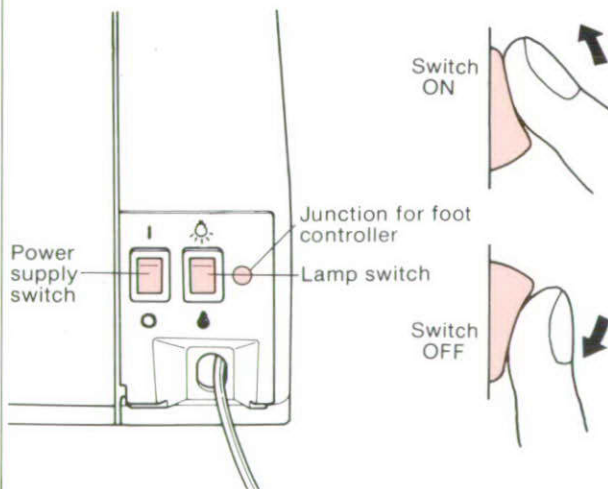

3 Pattern selection button for 20 patterns

- Press this button for selecting your pattern.
- Pattern is selected one by one.

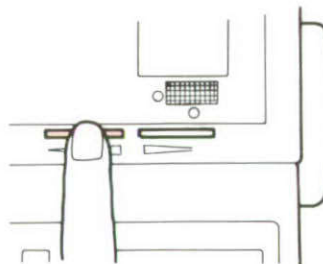

Pattern is selected to the direction of the first button depressed with double speed.

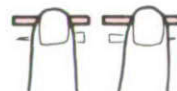

4 Pattern change lever

When lever is set at left position, daily pattern is displayed.

When lever is set at right position, memory pattern is displayed.

* Memorized stitch length and zigzag width are obtained automatically.

* Change the presser foot if necessary in accordance with the symbols of each pattern indicated.

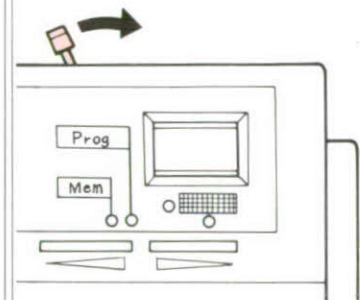

Depending on setting the functional regulator(s), you can hear the instruction from the machine. Follow the instruction since it tells you the correct setting. Some examples you might meet at the initial steps.

VOICE MESSAGE

- * "Please lower presser foot lever."
You have depressed start/stop or reverse button before you lowering the presser foot lever.
- * "Reverse stitch cannot be obtained using this pattern."
You have depressed reverse button on the patterns which cannot be allowed for reverse sewing.
- * "Please use a foot controller."
You have depressed start/stop button when foot controller has been connected.



5 Start/stop button

Depress this button to start sewing.
Depress again this button to stop sewing.

- NOTE: 1. While keeping this switch depressed, machine runs at slow speed.
2. When foot controller is connected to machine, this button does not work.

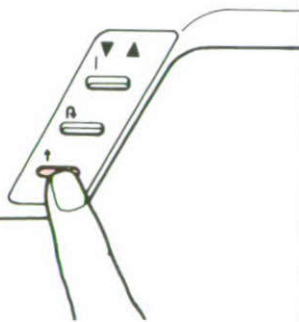

6 Reverse button

While keeping this switch depressed, machine makes reverse sewing or bar-tacking.

- Reverse sewing
Reverse feed sewing.
Bar-tacking
Sews 3 stitches only and stops automatically.

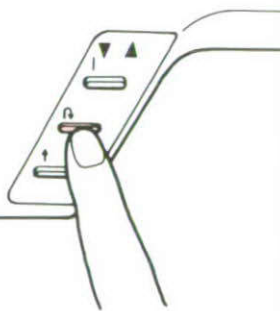

7 Needle position button

You can change needle position by simply depressing this button.

- ▲ ... Needle stops at its highest position.
 - ▼ ... Needle stops at lowest position.
- NOTE: When you depress this button alternatively, you can stitch one by one for basting.

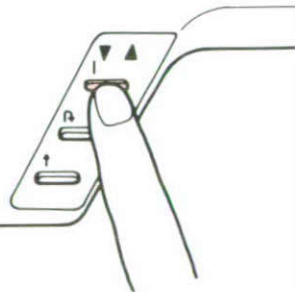

8 Speed control lever

While the machine is running, you can change sewing speed by simply moving this lever. When foot controller is used, the speed can be changed depending on how you press the foot controller but the fastest limit is controlled by this lever.
Select the speed to suit your sewing need.
Slow speed..... Intricate work
Fast speed..... Normal work

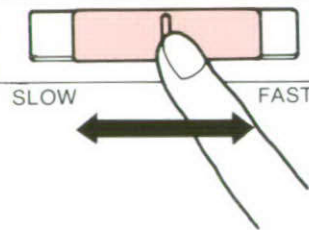

9 Stitch width manual lever Stitch length manual lever

1. Touch release button(s) for manual setting(s).
 2. Move the lever to your desired position.
- NOTE: If LED sign is not on, you cannot make manual setting. (see page 21 & 22.)

Use these when you wish to have a length/width other than automatic setting.

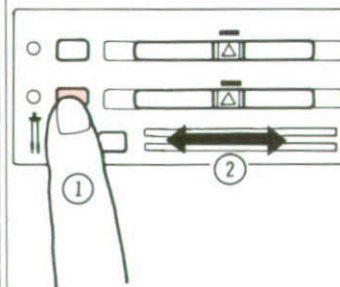

BOBBIN THREADING

Set the Lower Thread Correctly

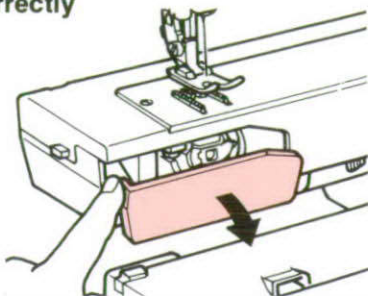

Lift the table and pull it toward you. Open shuttle cover as shown left.

1 Removing bobbin case

1. Grasp bobbin case latch and pull toward you.
2. Release latch and bobbin will drop out of case.

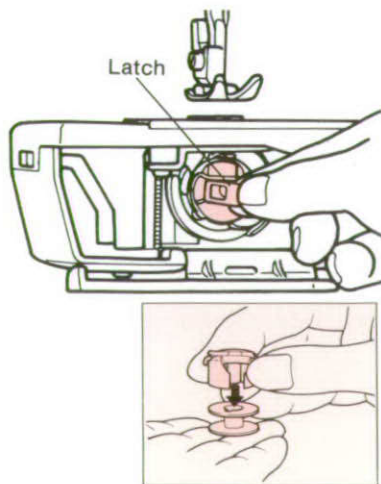

2 Place thread-spool

Set holder firmly so that thread spool will not turn.

Set holder firmly with thread-end appearing in front.

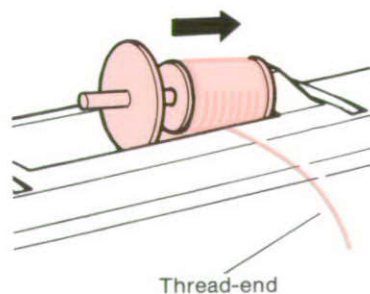

3 Guide thread around the thread guides

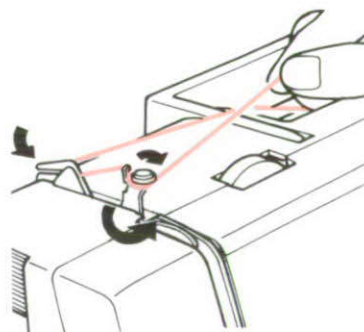

4 Place empty bobbin on bobbin-winder-pin

1. Wind thread around bobbin 5-6 times.
2. Push bobbin to right.

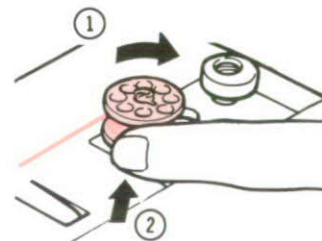

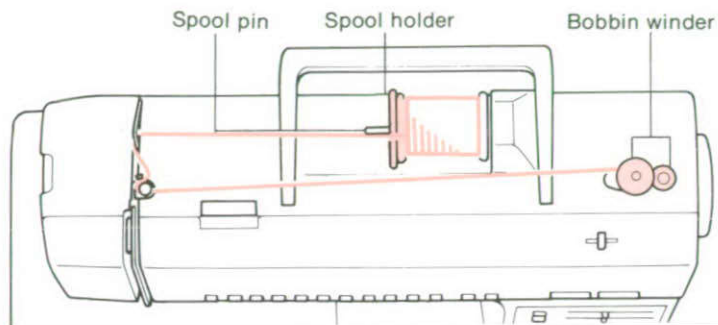

5 Start machine

3. Set speed control lever at the top speed.

* Bobbin winding stops automatically when bobbin is full.

* Stop the machine by depressing the start/stop button.

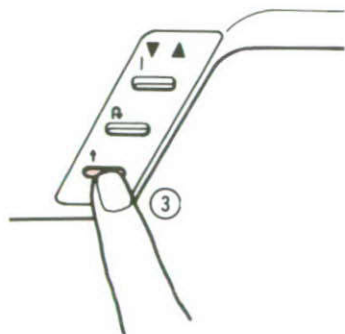

6 Remove bobbin

4. Remove fully wound bobbin by pushing it to the left.

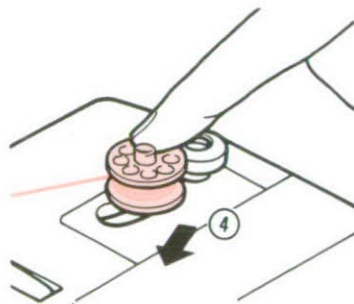

7 Insert bobbin into bobbin case

1. Release the latch.
2. Draw thread into slot and guide under the tension spring.

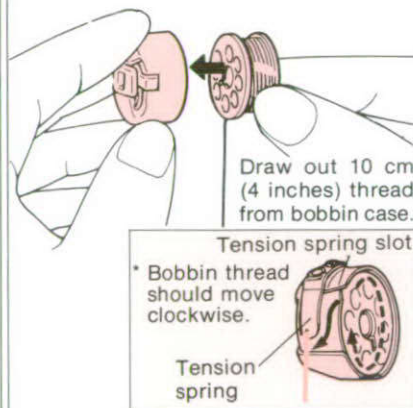

8 Replacing bobbin case

With latch open, slide case onto the notch.

Release the latch and push back case until it clicks into place.

Close shuttle cover.

NOTE: If bobbin case is not fitted properly bobbin case will come out from the shuttle immediately after starting the machine.

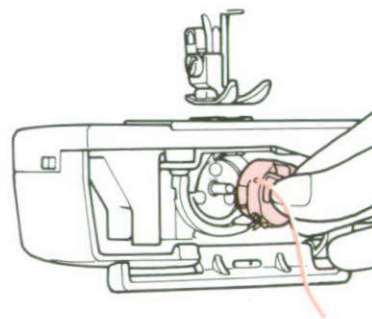

UPPER THREADING

Threading Correctly

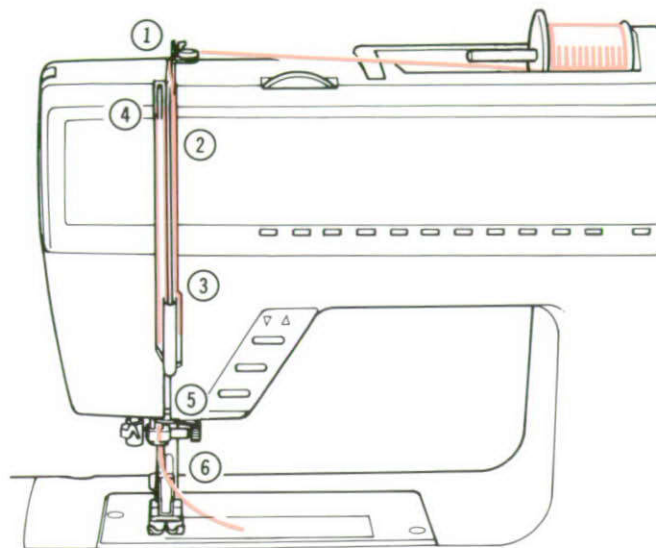

1 Upper threading guide

* Before threading, raise presser foot and needle.

NOTE: Change needle position only with needle position buttons. Do not try to turn balance wheel.

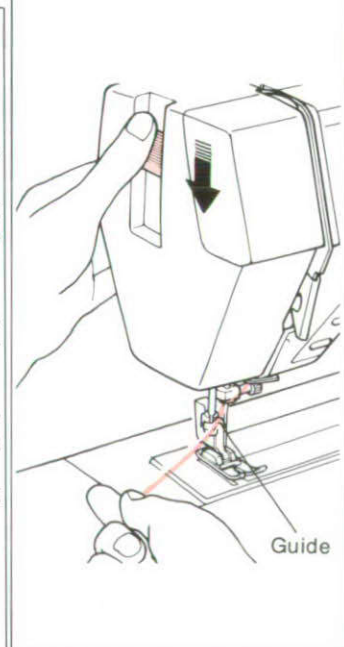
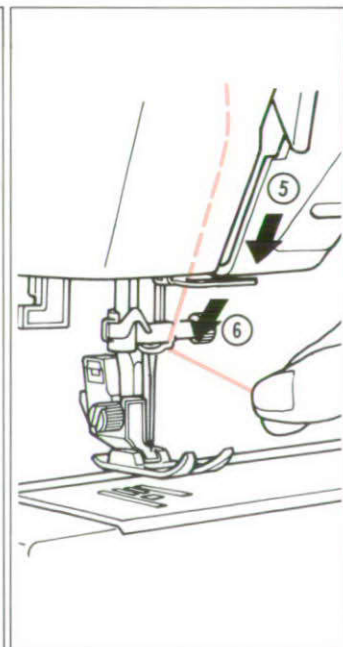
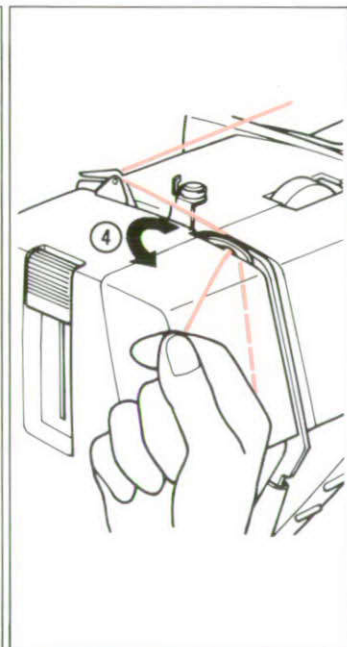
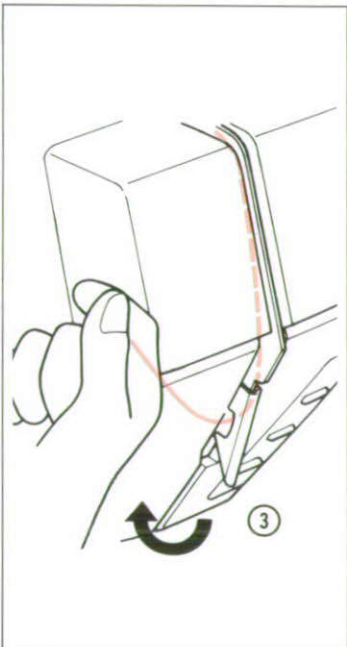
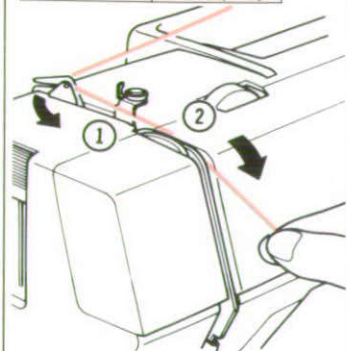

2 Lower needle threader

1. Lower presser foot.
2. Guide thread along thread-catcher.

CAUTION

1. Do not bring down needle threader while machine is running.
2. Do not turn the balance wheel while you use needle threader.
3. Auto-threading device cannot accept combinations as shown left.

Needle	Thread (cotton)
No. 9	30, 50, 60
No. 11	30, 50
No. 14	30
No. 16	20

** Transparent nylon thread can be used regardless of the chart providing needle used is No. 14-16.*

3 Guide through the hook

3. Bring thread to right side passing beneath the catcher.
4. Lower needle threader as far as it will go.

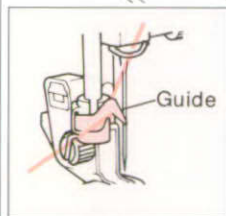

** Make sure needle catches the thread by pulling thread slightly towards you.*

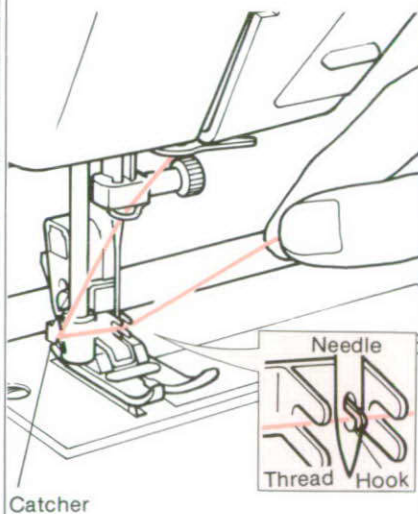

4 Return needle threader to raised position

Release thread for this work.

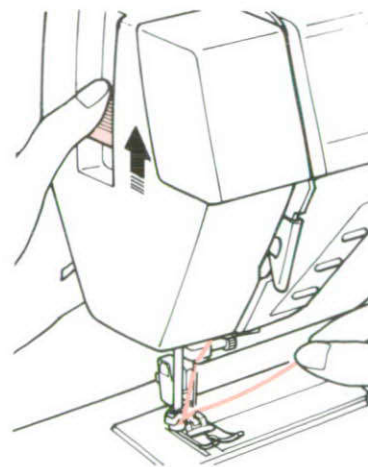

5 Pull out thread from needle

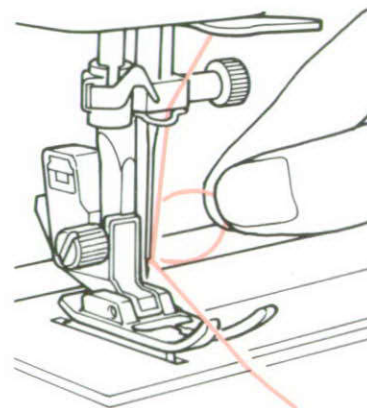

DRAWING OUT LOWER THREAD

Now You are Ready to Sew

1 Draw out lower thread

1. Holding upper thread gently, depress needle position buttons. (Needle moves down and up and catches lower thread.)

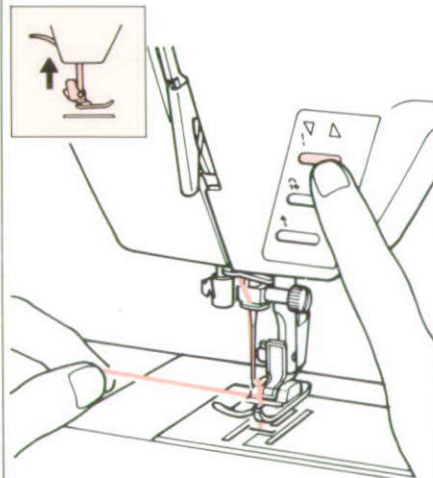

2. Pull upper thread

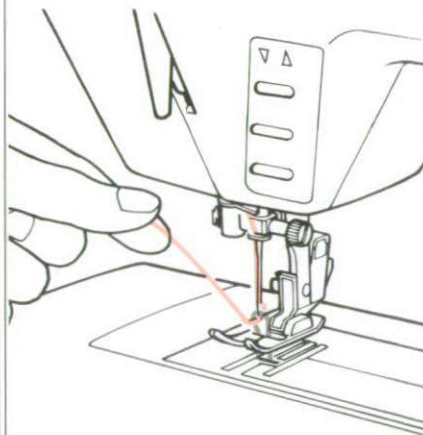

3. Pull upper thread to draw out lower thread and draw threads 10 cm long (4 inches) to the back of presser foot.

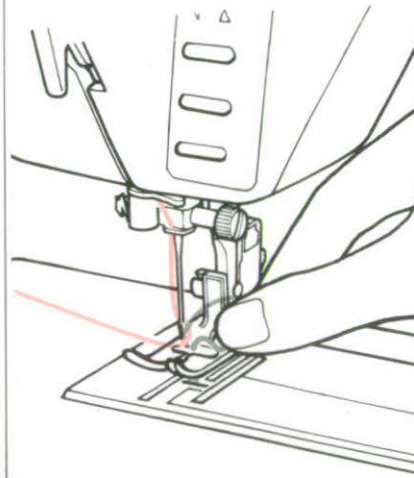

2 Set fabric under presser foot

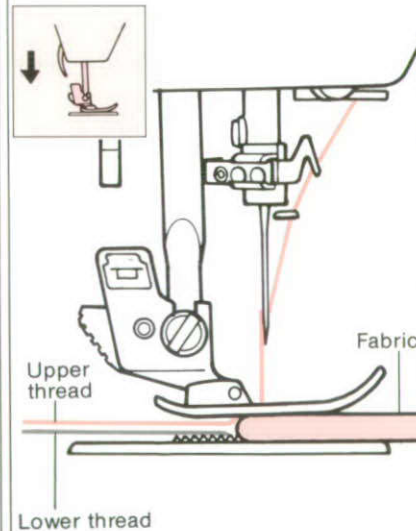

TENSION ADJUSTMENT

Some Points to Know

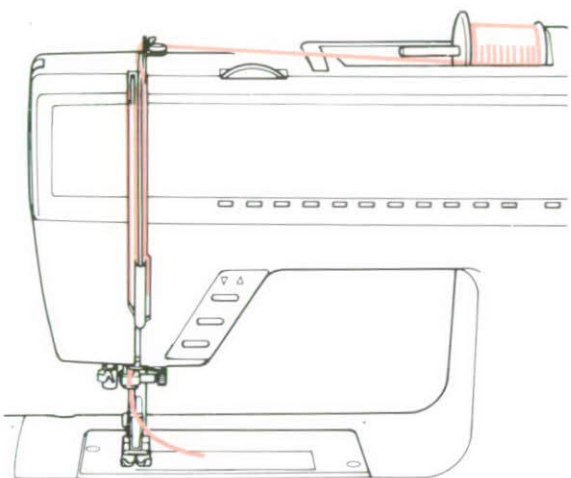

• Thread tension

Use thread tension dial at 5 usually.

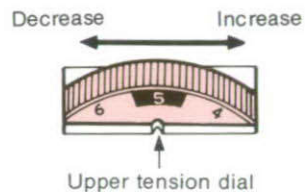

Locking is obtained in the middle of fabrics.

If thread tension is not adjusted correctly, sewing performance shows irregular stitches, puckering or thread breakage.

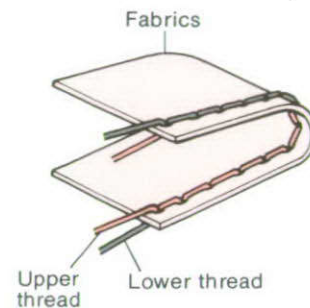

• Generally, thread tension can be adjusted by turning upper tension dial

Upper tension too tight.

The upper thread lies on the upper surface of the material, pulling the lower thread as shown.

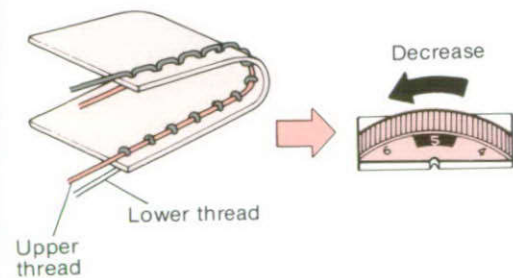

Lower tension too tight.

The lower thread lies on the under surface of the material, pulling upper thread down as shown.

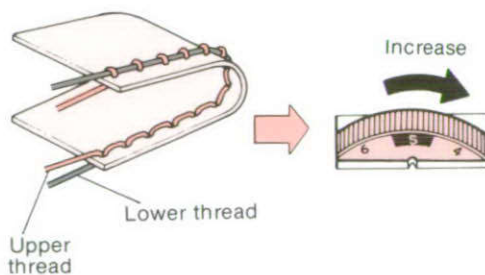

• How to check the lower tension

The bobbin thread tension has been set at the factory for most types of fabrics. It will rarely require adjustment.

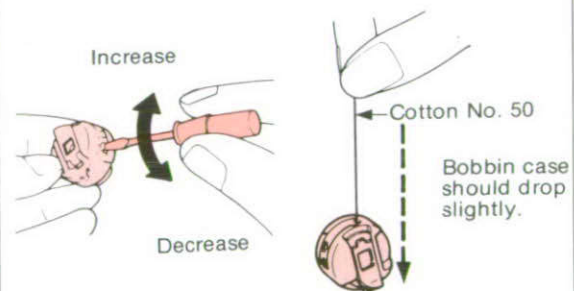

CHANGING NEEDLE

How to Change Needle and Presser Foot

★ ACCESSORY COMPARTMENT

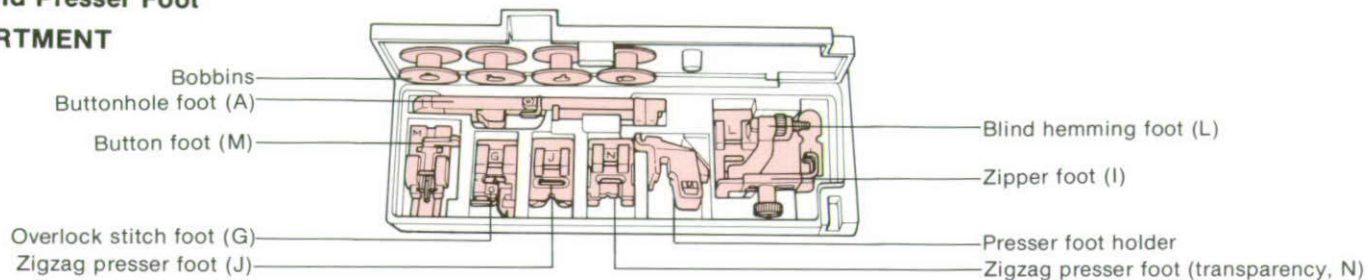

• NEEDLE

Removing needle

Lower presser foot.
Loosen thumb screw and remove needle from machine.

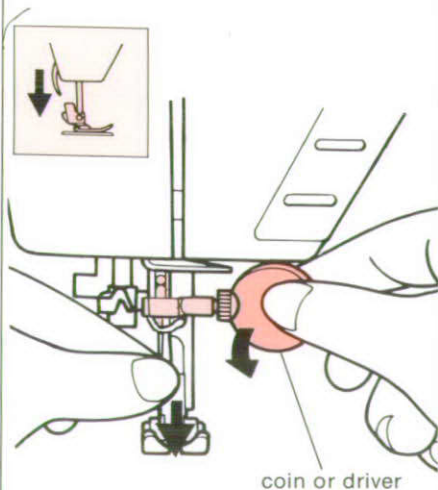

Replacing needle

Insert needle as far up as it will go against the needle stop with flat side facing to the back.
Tighten thumb screw firmly.

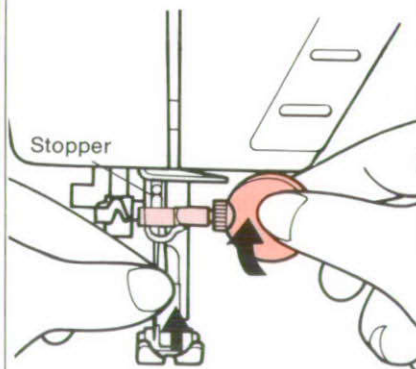

• PRESSER FOOT

Remove presser foot

Raise presser foot.
Push button.

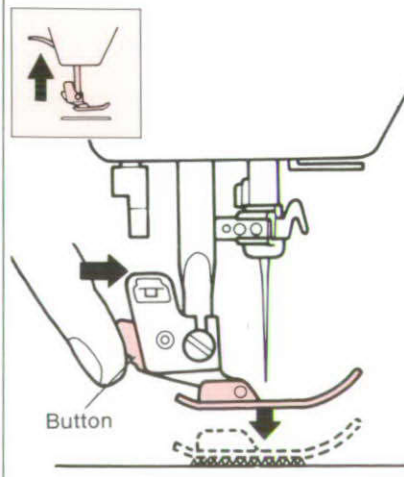

Replacing presser foot

Place presser foot under holder.
Presser foot pin must be placed under the holder.
Lower lifter so that holder catches presser foot firmly.

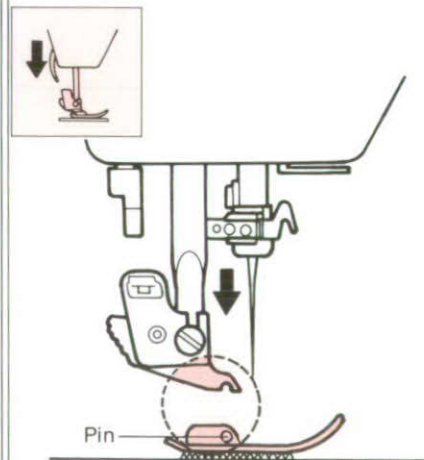

★ ACCESSORIES

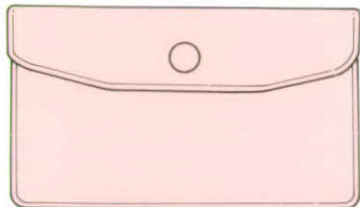

Accessory bag

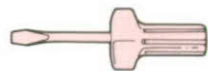

Large screw driver



Seam ripper



Tweezer



Needle set



Small screw driver



Oil tube



Cleaning brush

• Removing holder

Raise presser foot.
Unscrew and remove holder from machine.

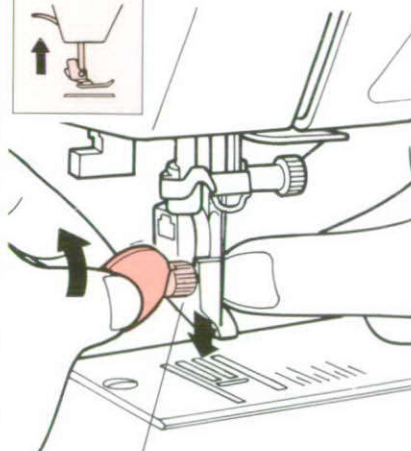

Presser foot holder

• Attaching zipper foot

Attach foot to machine.
Screw firmly.
Foot can be used either side of needle.

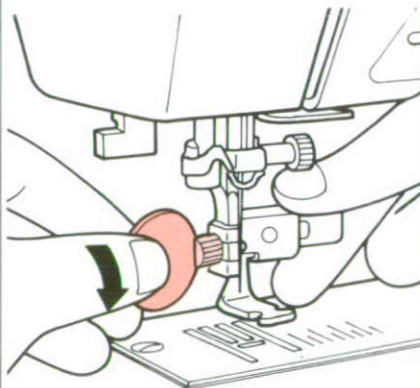

★ CASE FOR SIDE CUTTER

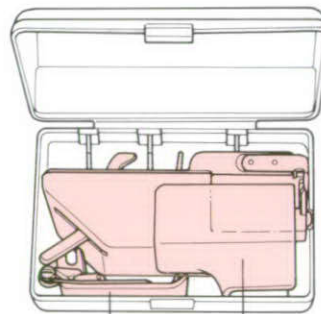

Side cutter
presser foot

Side cutter

SIDE-CUTTER

Attaching Side-Cutter

★ Storing side-cutter

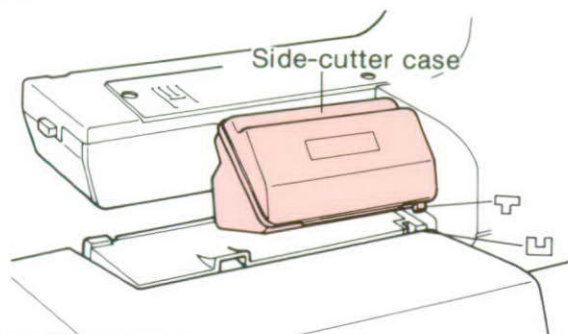

Protruding portion must be guided through groove for installing case under tubular bed.

1 Removing presser foot holder

Complete upper threading before attaching the side cutter and pull lower thread up. Leave both threads about 15 cm (6 inches).

NOTE: After setting side-cutter to machine, auto-threading device does not work.

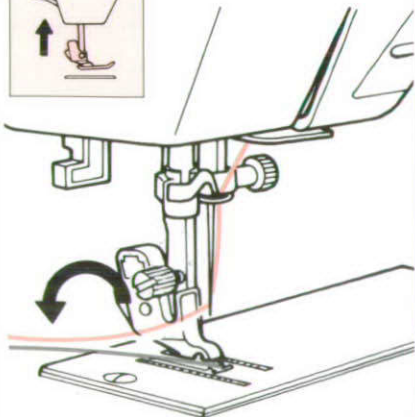

2 Insert needle plate into tubular arm

Depress right side of needle plate and slide it into tubular arm.

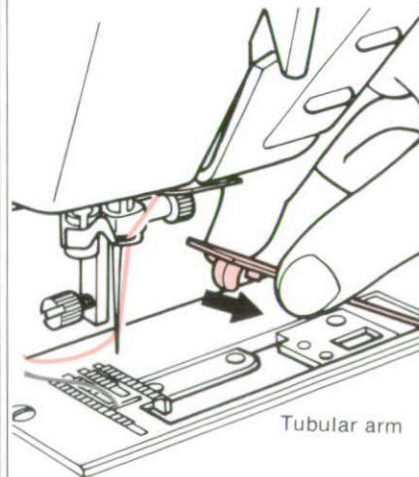
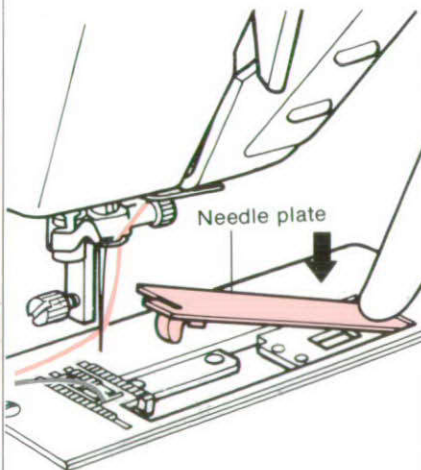

3 Attaching side cutter presser foot

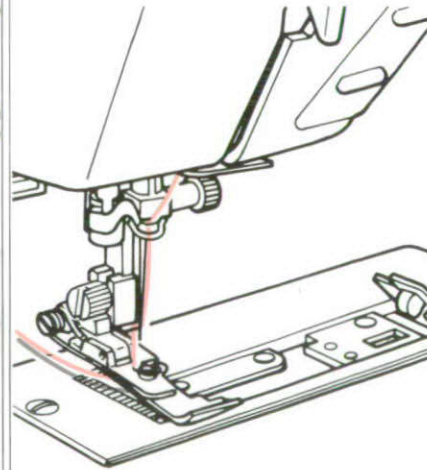

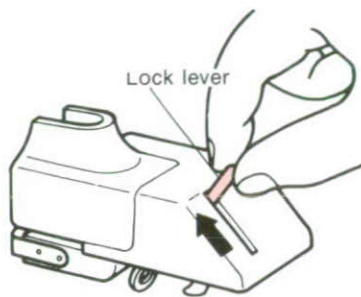

(Caution)

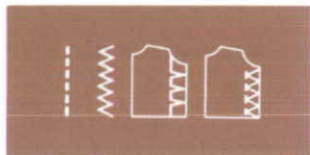

- Side cutter device is used only for the 4 patterns at left. The machine will automatically select the overedge stitches if you select a pattern other than the four as indicated if side cutter attachment is installed.

- Use always side-cutter presser foot when you use side cutter.
- Side-cutter device does not accept materials thicker than three ply of denim.

4 Set knife on the side-cutter at raised position

Before attaching side-cutter, set knife and lock lever at raised position.

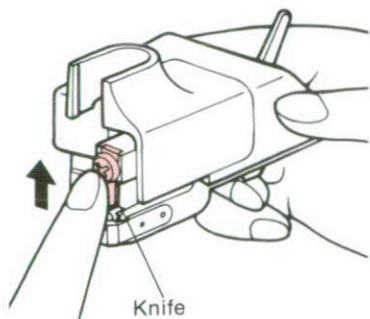

5 Set side-cutter on machine

1. Install guide pins onto the free arm holes.
2. Press side-cutter lightly on free arm.
3. Set lock lever to locking position.

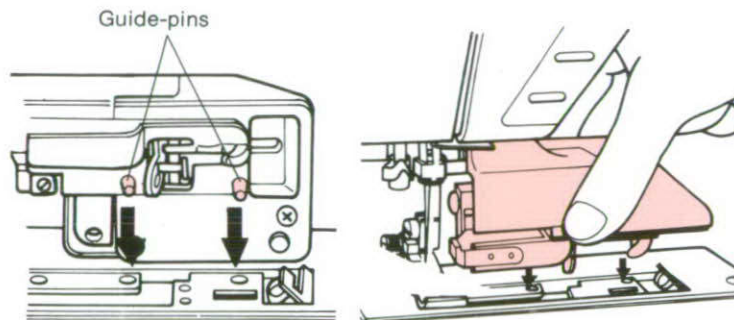

6 Lock side-cutter lock lever

Press side-cutter lightly on tubular arm. Set lock lever to locking position firmly.

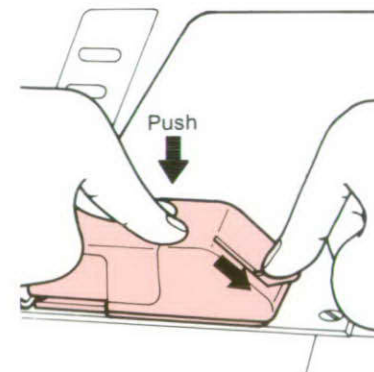

OTHER FUNCTIONS

• Drop feed lever

- ▲▲ ... Set at the right position for feed dog up for feeding.
- ▲▲ ... Set at the left position for feed dog down for no feeding.

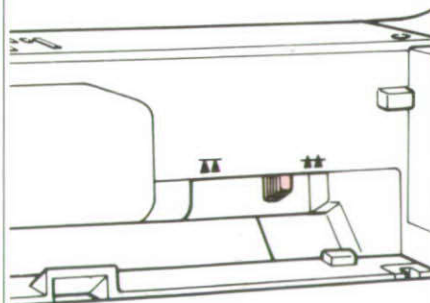

• Pressure control lever

When pressure control lever is lifted up, pressure on presser foot is released.

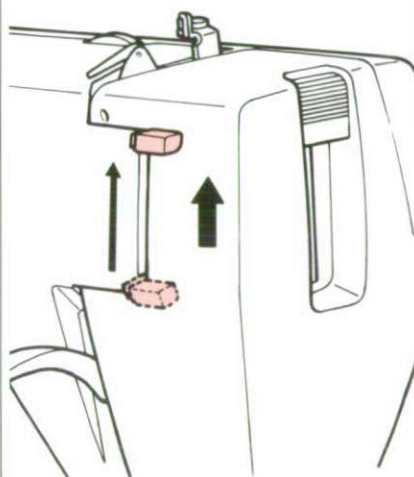

• Double lift presser foot lifter

For normal and very thick fabrics.

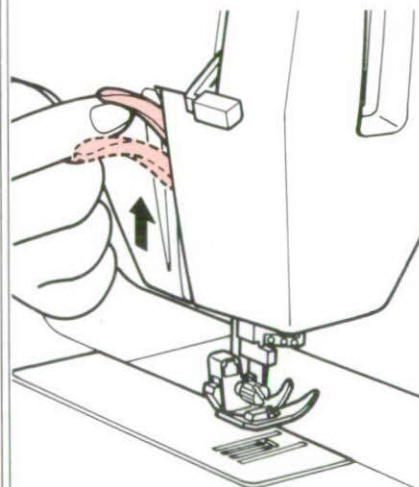

• Thread cutter

1. Raise presser foot.
2. Draw fabric to the left side.
3. Cut threads by using thread cutter provided on the back of machine.

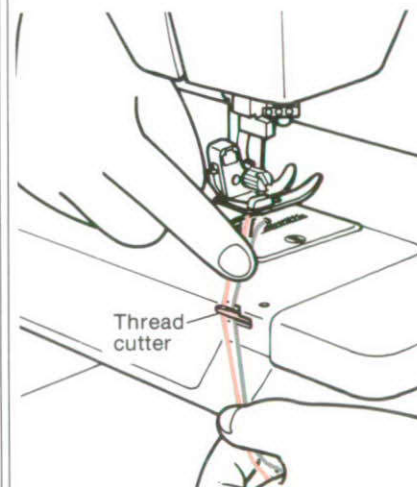

One point advice

Twin needle

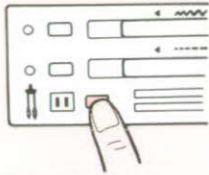

1. Insert the twin needle.
2. Thread each needle.
The groove should face you.
3. Touch release button for twin needle and check the LED sign is on.
4. The machine selects correct stitch width and length.

Note: The twin needle with larger size number other than the one as illustrated left originally put in the accessory compartment is not acceptable.

Example

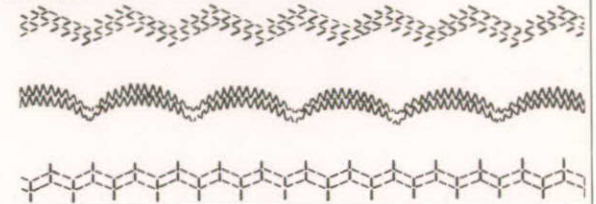

•How to change the bulb

1. Raise pressure control lever.
2. Loosen fastening screw.
3. Remove face plate.

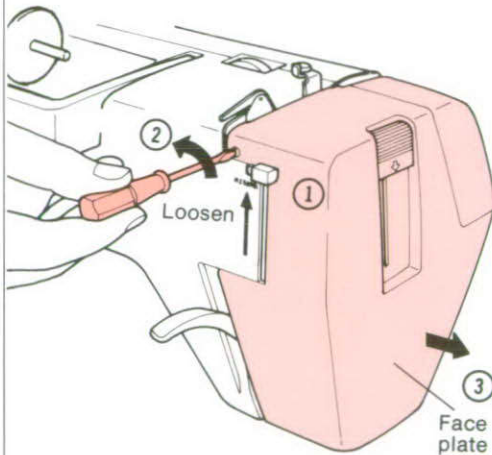

Remove bulb by turning counterclockwise.
Replace bulb and swing face plate to close.

NOTE:

- 1) Disconnect electric plug from wall outlet before removing bulb.
- 2) Always use CORRECT SPARE BULB.
MAXIMUM INPUT OF LAMP ... 12V, 4W

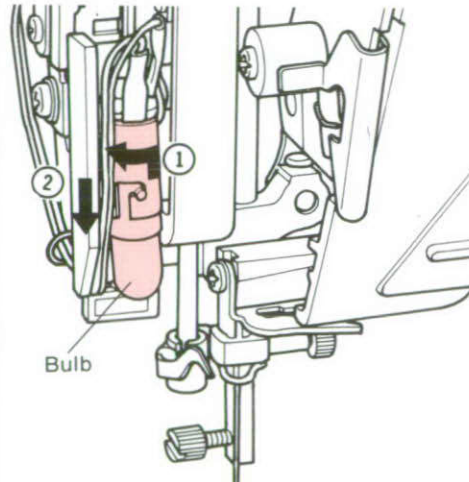

Fix face plate onto the arm of machine by guiding two pins and fasten screw.

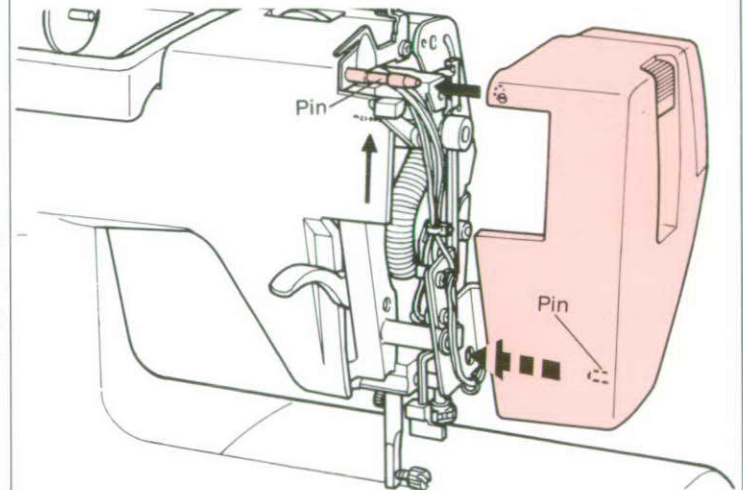

MAINTENANCE & CHECK POINTS

For Longtime Use

•Cleaning

Cleaning

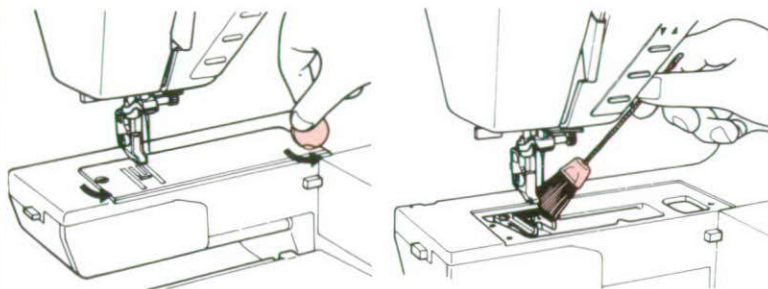

Care should be taken that the needle plate and feed dog are always kept clean.

- Do not try to disassemble machine other than illustrated.

•Oiling

Oiling

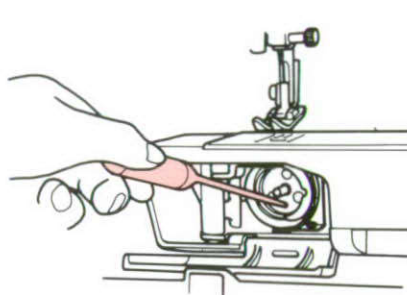

After oiling, drive machine without load for a while.

- Wipe up any excess oil.

Periodically, depending on usage, clean and oil machine by using a few drops of oil on areas indicated.

- Before cleaning and oiling, disconnect power plug from socket outlet.
- Use sewing machine oil and not gasoline, benzine or thinner.

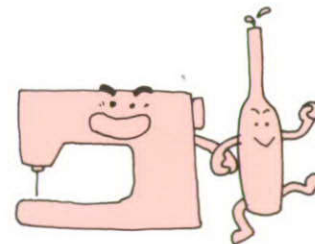

Do not store sewing machine near heater or electric iron.

* BUZZER WARNING

- * When sewing machine is locked due to entangling of thread, etc.
 - Sewing machine stops automatically.
 - After 5 seconds it will be restored, and you can restart the machine.
 - Before restarting sewing, correct the problem.
- When checking the machine, the machine must be disconnected from the power supply by removing the plug from the socket outlet.

* SWITCHES

Double switching is not allowed. In other words, you can not make another switching operation if you keep depressing original switch except pattern select switches.

* SAFETY STOP

- If anyone accidentally touches one of the control switches while the machine is in operation (except the manual stitch width and length switches) the machine will stop immediately.
- Also if pressure foot lever is raised up.
- Also automatic bobbin winder device is moved.

Minor Adjustments

• In case machine does not work satisfactory, check following the points. If problem is something other than listed below, contact service center for adjustments.



• Material not feeding

1. Did you set manual stitch length lever at 0?
2. Did you set pressure control lever up?



• Needle breaks

1. Is needle inserted correctly?
2. Did you pull fabric excessively?
3. Is the combination of needle, threads and fabrics correct?
4. Is the needle bent or blunt?
5. Did you install wrong presser foot?

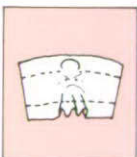

• Haloing on the seam

1. Is threads tension right?

• Puckering

1. Is threads tension too tight?
2. Is threading right?



• Slow machine speed or high noise

1. Is needle plate/feed dog area clean?



• Upper thread breaks

1. Is upper threading correct?
2. Is upper tension too tight?
3. Is the combination of needle, thread and fabrics correct?
4. Did you turn the balance wheel wrong in the direction?

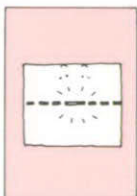

• Skipping stitches

1. Is needle inserted correctly?
2. Is the needle bent or blunt?
3. Is the combination of needle, thread and fabric right?
4. Is the threading correct?
5. Did you clean the under side of needle plate?



• Bobbin thread breaks

1. Is the tension on bobbin case correct?
2. Is the threading on bobbin case correct?



• Machine does not start













1. Did you turn on the main power switch?
2. Is machine correctly plugged in at machine and socket outlet?
3. Check fuse in plug.

**If power supply stops during operation.*

• *Disconnect plug from socket outlet.*

• *Follow "Set up the machine, page 5" for resetting.*











SEWING CHART

	Stretch stitch		Overlock	Multi-Zigzag stitch	Bar-tack	Button-hole				Straight	Zigzag
	J	J	J	J	A	A	A	A	A	J	J
Presser foot	J	J	J	J	A	A	A	A	A	J	J
Pattern											
Reverse switch	E	E	E	E						R, e	R, e
Stitch width manual switch	*		*	*	*	*	*	*	*		*
Stitch length manual switch	*	*	*	*	*	*	*	*	*	*	*
Side cutter											
Main purpose	Stretch fabrics		Joining Fabrics	Elastic fabrics	Bar-tack	One-piece dress	Heavy jacket	Normal jacket	Shirts & pajamas	General straight stitches	General zigzag stitches
Sewing Guide (Page)	26		52	28	37	33				25, 29, 31 45	29, 51 53

- E Ending the seam
- e Ending the seam when side cutter is used
- R Reverse stitches when side cutter is not used
- * Available manual setting with LED sign
-  Can use side cutter

Presser foot symbol



Overedge stitch		Blind stitch		Buttoning		Scallop		Shell tuck	Decorative stitch	
G	G	L	L	M	M	J	J	J	N	N
									Prog	Mem
E	E	E	E			E	E	E	E	E
*	*	*	*	*	*	*	*	*		*
*	*	*	*			*	*	*		*
										
Normal fabrics	Elastic fabrics	Normal fabrics	Elastic fabrics	Normal-size button	Small-size button	Scallop		Shell tuck	Various decorative stitches	
27		41		39		43		50		

SEWING GUIDE BOOK

CONTENTS

STITCH PATTERNS	24
STRAIGHT STITCHING	25
Stitching on stretch fabrics	26
Using triple stretch stitch	26
OVEREDGING	27
On stretch fabrics	28
Sewings on frayable fabrics	28
USING THE SIDE-CUTTER	29
ZIPPER INSERTION	31
BUTTONHOLES	33
BAR-TACKS	37
BUTTON SEWING	39
BLIND STITCH	41
SCALLOP STITCH	43
ORIENTAL SEAM FINISH	45
FAGOTING	47
PIN TUCKS	49
SHELL TUCKS	50
APPLIQUE	51
PATCH WORKS	52
DARNING	53
SOME HINTS TO KNOW	54
Placing the fabrics	54
Guiding the fabrics	55
Top stitching enclosed seams	56
HOW TO STITCH OVER AWKWARD AREAS	57
Stitching on the collar	57
Starting with thick materials	57
Stitching over the hurdle	57
Stitching over thin materials	58
Stitching with big seam allowance	58
MEMORY	59
PROGRAMMING	65
PROGRAM SHEET	71

Stitch Patterns

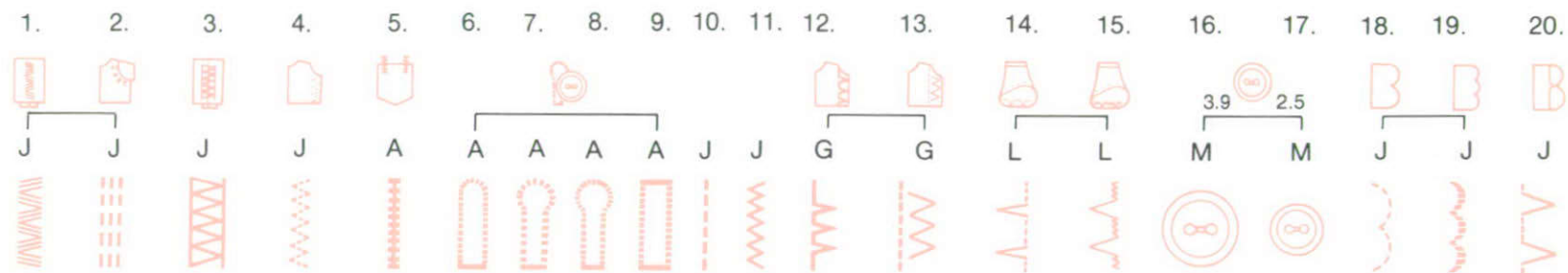

1. Rick-Rack Stitch
2. Stretch Stitch at left position
3. Overlock Stitch
4. Multi-Zigzag Stitch
5. Bar-Tacking Stitch
- 6.-9. One Step Buttonhole
10. Straight Stitch at left position

11. Zigzag Stitch
- 12.-13. Overedge Stitch
14. Blind Stitch
15. Stretch Blind Stitch
- 16.-17. Button Sewing Stitch
- 18.-19. Scallop Stitch
20. Shell tuck stitch

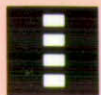

Straight Stitching

ZIGZAG **NORMAL**

BROAD	→	COTTON	60-80
TAFFETA	→	SYNTHETIC	60-80
GABARDINE	→	SILK	50-80
FLANO	→		

11-14 NEEDLE

THINE

LAWN	→	COTTON	60-80
GEORGETTE	→	SYNTHETIC	60-80
PORAL	→	SILK	50-80

9-11 NEEDLE

THICK

DENIM	→	COTTON	40-50
COTELINE	→	SYNTHETIC	50
TWEED	→	SILK	50

1 Pinning fabrics for machine sewing

Draw out upper and lower threads by 15 cm (6 inches) to the back of machine.

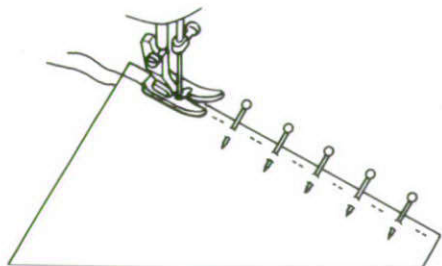

2 Start machine

1. Sew reverse stitches to the edge of fabrics.
2. Stitch forward.

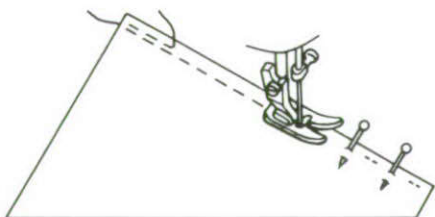

* Just guide fabric slightly as machine feeds fabrics automatically.

3 Ending the seam

1. Stop machine at the end of the seam.
2. Sew reverse stitch approx. 1 cm (2/5 inch).
3. Set needle at up position (▲) and draw out the work backward and cut the threads provided back of machine.

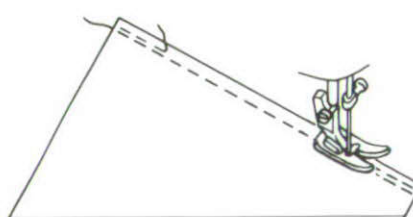

* Using the iron, press seam flat.

One point advice

• How to change sewing direction

1. Set needle at down position (▼).
2. Raise presser foot and turn the fabric the needle works as axis.

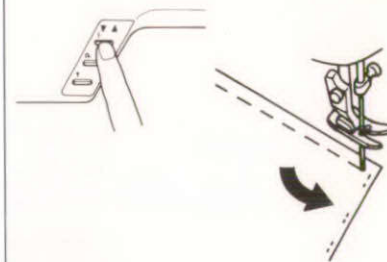

* Place fabrics approx. 1 cm (2/5 inch) from the edge so that first reverse stitches are obtained.



11-18
NEEDLE

★ STRETCH FABRICS

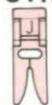

ZIGZAG



STRETCH

TRICOT

JERSEY



STRETCH



STRETCH
9-14 NEEDLE



★ STRONG SEAMS



ZIGZAG



NORMAL

BROAD
TAFETTA
GABARDINE
FLANO

COTTON
SYNTHETIC
SILK

60-80
60-80
50-80



11-14
NEEDLE



One point advice

3. Lower presser foot and start.

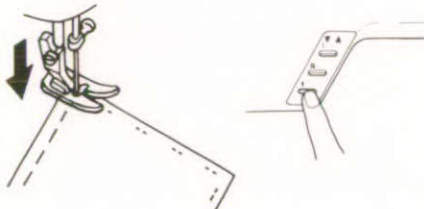

• Stitching on stretch fabrics

1. Baste first along with the marking line.

Marking line

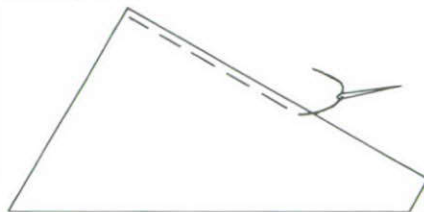

2. Guide the fabric with your right hand slightly, stitch close to the marking line.

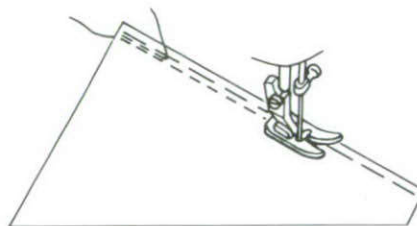

* Do not attempt to pull the fabrics excessively.

• Using triple stretch stitch

This stitch gives stronger seams.

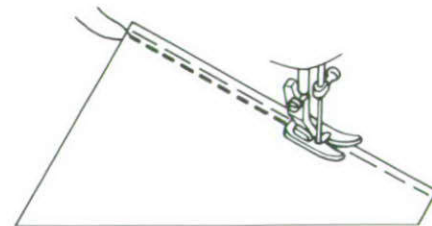

* Care should be taken that seam line is followed to the marking since this is a forward and reverse combined stitch.



Overedging

ZIGZAG OVER EDGE	NORMAL	BROAD → COTTON	60-80	11-14 NEEDLE	THINE	LAWN → COTTON	60-80	9-11 NEEDLE	THICK	DENIM → COTTON	40-50
		TAFFETA → SYNTHETIC	60-80			GEORGETTE → SYNTHETIC	60-80			COTELINE → SYNTHETIC	50
		GABARDINE → SILK	50-80			PORAL → SILK	50-80			TWEED → SILK	50

1 Preparation

Set fabric with the presser foot guide.

Make sure that the needle does not hit overedging foot when you select zigzag stitch and touch release button for manual setting.

Do not hit needle

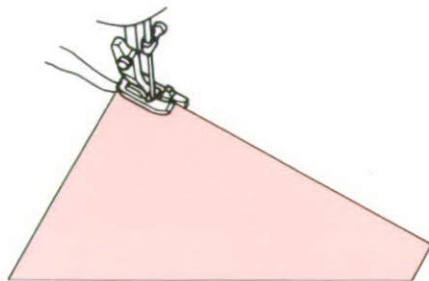
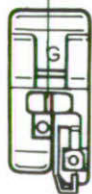

*Trim the fabric edge.

2 Start the machine

Guide fabric carefully so the edges are aligned with the foot guide.

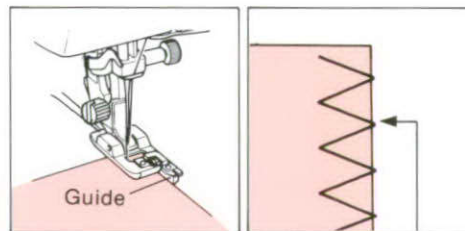

Needle should stitch slightly over edge of fabric.

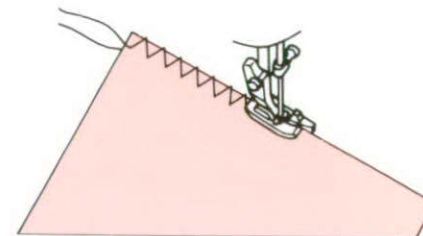



11-18
NEEDLE



★ **STRETCH FABRICS**



★ **FRAYABLE FABRICS**

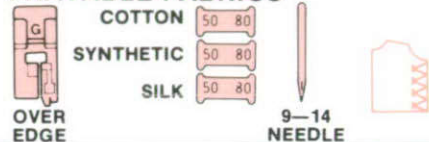

3 Ending the seam

Stop at the end of seam.

• On the stretch fabrics

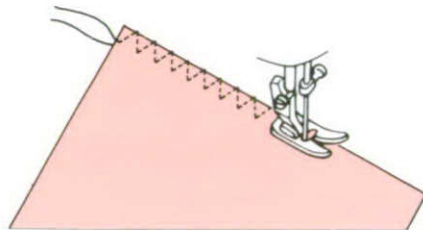
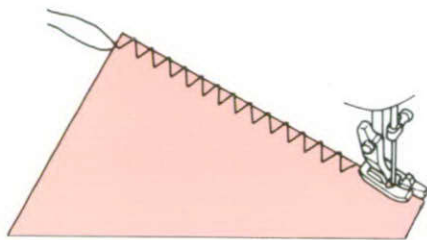

Do not attempt to pull the fabric excessively.

• Sewings on frayable fabrics

Using this pattern on frayable fabrics is recommended.

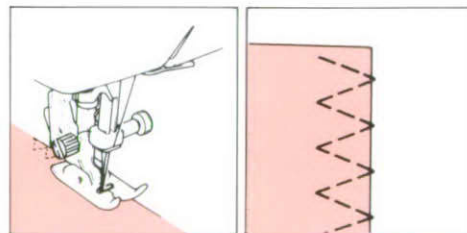

Needle drops slightly beyond fabric edge.

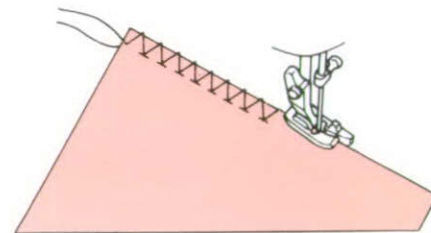

Basket and towel fabrics, etc. (Setting manual stitch width at 3 is recommended.)



Using Side-Cutter



SIDE CUTTER

- Use the side cutter presser foot with the following stitch patterns only.

1 Attach side-cutter

Complete the upper threading before attaching. (Page 15)

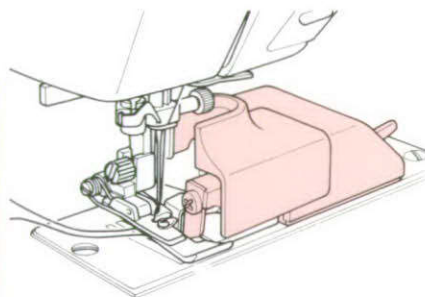

2 Trim on the fabrics

Make trim approx 1 cm (2/5 inch) at the end of fabrics.

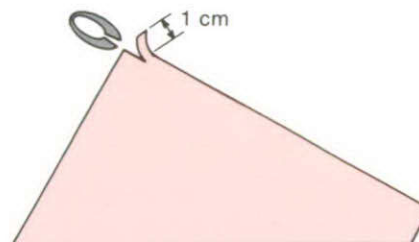

3 Start the machine

Draw threads under foot and pull back lightly when machine starts.

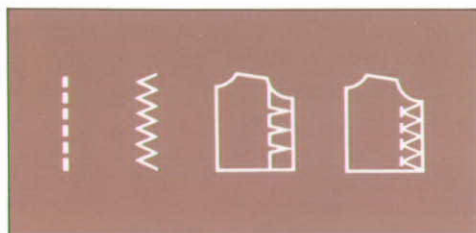
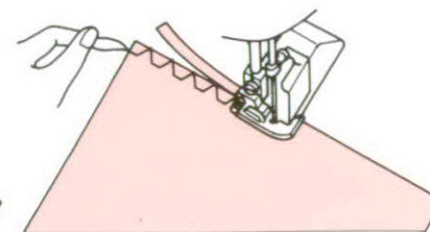

After side-cutter is set on machine, machine selects one of above 4 stitches automatically.

* Use the tweezers in case upper threading should be required after attaching the side-cutter.

Two ply sewing

- Use straight stitch

Cutting is made 0.4 cm (1/6 inch) from the fabric edge.

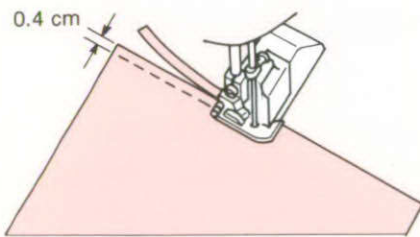





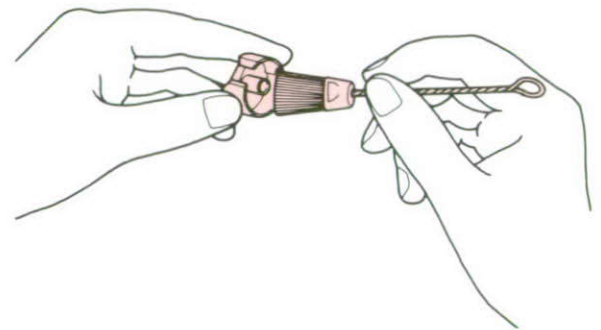
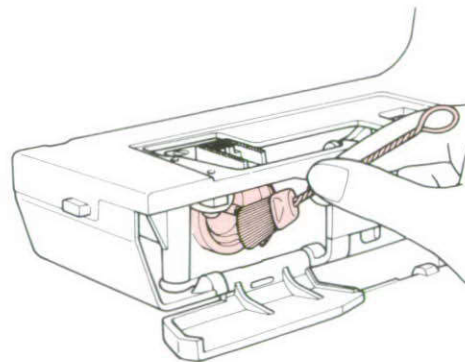











- Cleaning

Clean bobbin case, feed dog and shuttle area after using side-cutter.





Zipper Insertion

		BROAD → COTTON				LAWN → COTTON				DENIM → COTTON		
		TAFFETA → SYNTHETIC				GEORGETTE → SYNTHETIC				COTELINE → SYNTHETIC		
		GABARDINE → SILK				PORAL → SILK				TWEED → SILK		
ZIPPER			11-14 NEEDLE				9-11 NEEDLE					11-18 NEEDLE

1 Attach zipper foot to machine. (Page 14)

2 By turning balance wheel toward you, determine the zipper foot position.

Fastening screw is located at the back of foot.

Sewing left side of zipper.

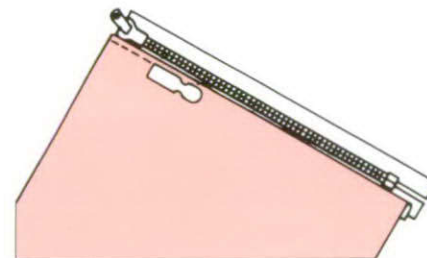
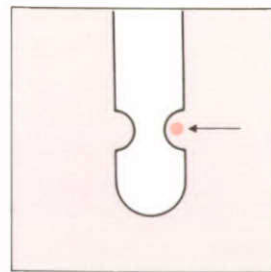
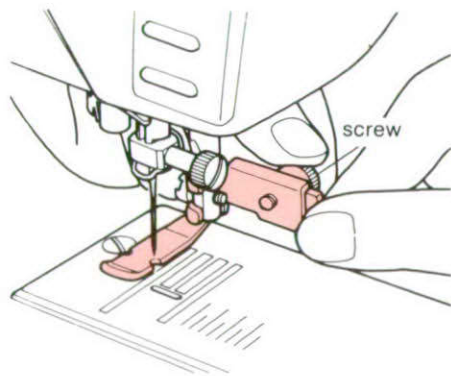
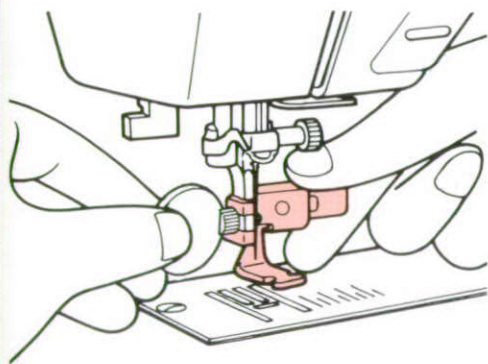

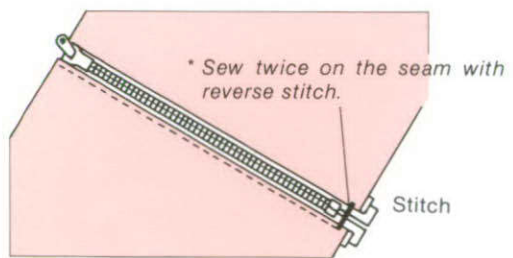

Sewing right side of zipper.

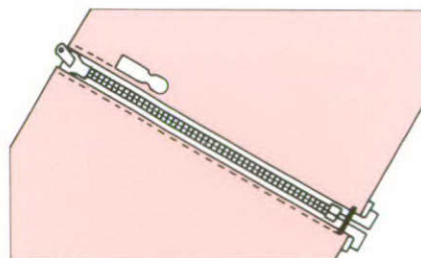
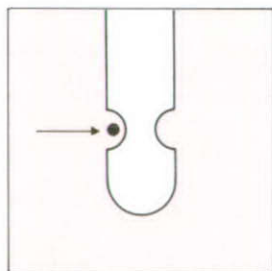

One point advice

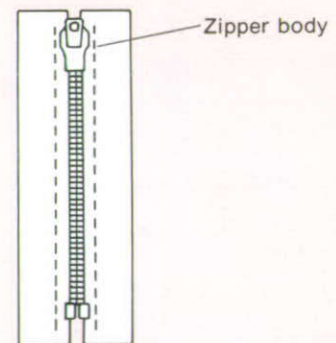

- Make sure that zipper foot does not touch zipper body.



Buttonholes

BUTTON- Shirt HOLE

NORMAL
Pajamas

BROAD	→	COTTON	60-80
TAFFETA	→	SYNTHETIC	60-80
GABARDINE	→	SILK	50-80
FLANO	→		

11-14 NEEDLE

NORMAL

BROAD	→	COTTON	60-80
TAFFETA	→	SYNTHETIC	60-80
GABARDINE	→	SILK	50-80
FLANO	→		

11-14 NEEDLE

THICK
Jacket

DENIM	→	COTTON	40-50
COTELINE	→	SYNTHETIC	50
TWEED	→	SILK	50

11-18 NEEDLE

1 Marking (Use tailor's chalk)

In case of Mark the position of button to be attached.

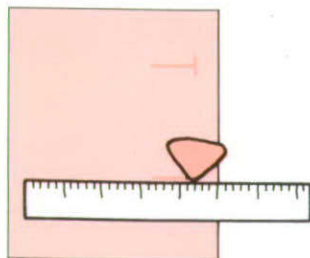

In case of Mark size of button as well as position of button.

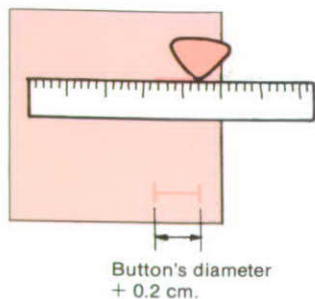

2 Attach buttonhole foot

Draw-up lower thread

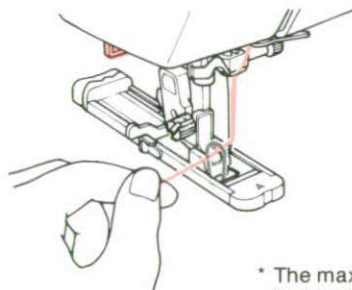

* The maximum capacity is 3 cm (1-1/6 inch) which is the diameter of button plus thickness of fabrics.

3 Lower presser foot

Lower presser foot in accordance with the marked line.

In case of : Place fabrics as below.

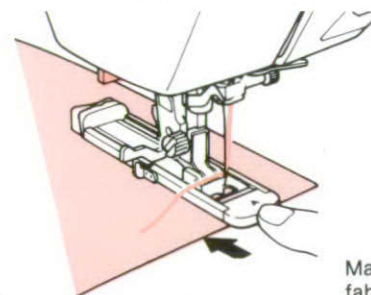

Set the marks on the foot and fabric in line.

Marks on fabric
Marks on the foot

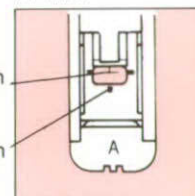

In case of : Place fabrics as below.

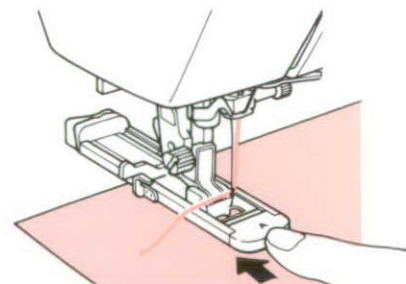



One-piece dress

- BROAD → COTTON 60 80
- TAFFETA → SYNTHETIC 60 80
- GABARDINE → SILK 50 80
- FLANO →

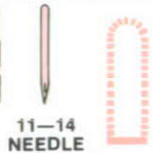

11-14 NEEDLE

4 Insert button

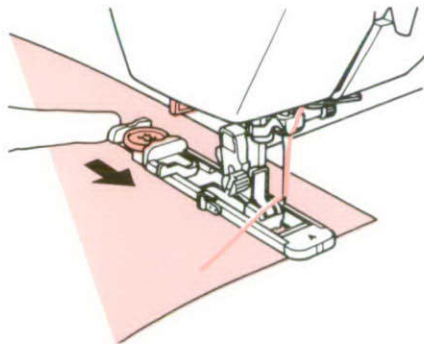

* Lift presser foot to high position if you are sewing thick fabrics.

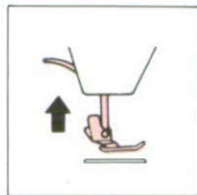

5 Draw out blue buttonhole lever

Pull down blue buttonhole lever.

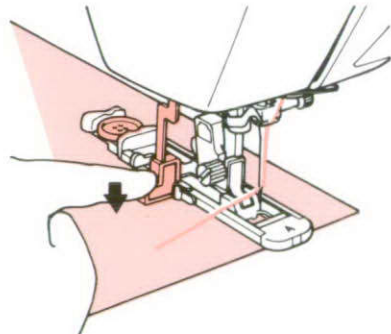

* Buttonhole lever should be set at the back side of notch.

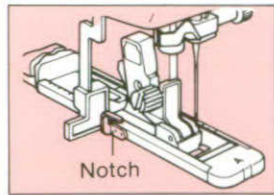

6 Start the machine

Hold the upper thread slightly.

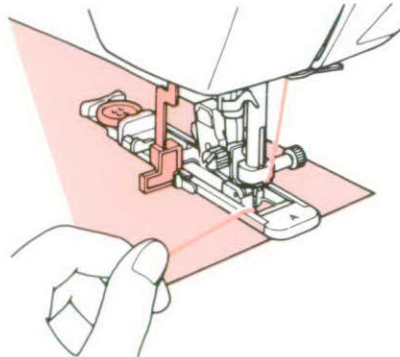

- * Hold the fabric lightly with fingers.
- * It stops automatically when finished.

7 Opening

Place pins at the bar tack and cut open with seamripper.

In case of

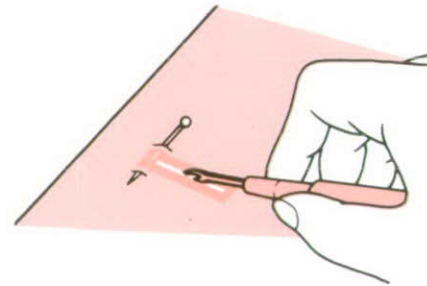

In case of

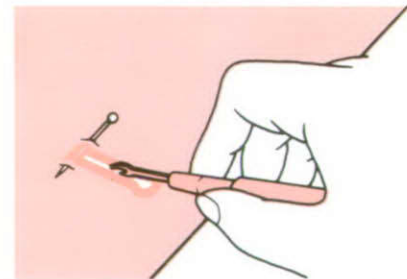

Be careful not to cut stitches.

★ BUTTONHOLE MAKING

(Fastening stitch is made with low speed and machine stops automatically when finished)

In case of



①



②



③



④



⑤



⑥



⑦



Fastening stitch

In case of

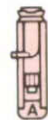

①



②



③



④



⑤



⑥



⑦



⑧



Fastening stitch

VOICE MESSAGE

* "Please lower blue lever."

.... When you start to sew buttonhole or bar-tack without lowering button hole lever.

* "Please raise blue lever."

.... When you start to sew stitches other than buttonhole or bar-tack without raising buttonhole lever.

One point advice

• On stretch materials





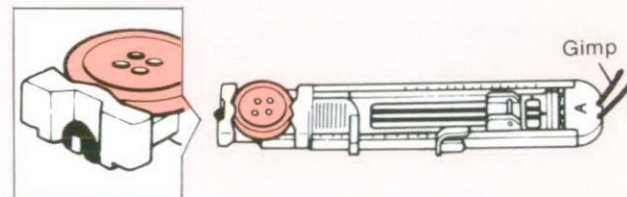

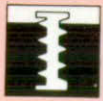



1. Glue non-stretch supporting materials on the wrong side of fabric.
2. Lower the foot.

- Placing gimp on the sole of foot for a reinforced buttonhole is recommended. (□ case only)
- If you made wrong buttonhole, restart from beginning.





Bar-tacks

 BUTTON-HOLE		BROAD → COTTON 			DENIM → COTTON 			LAWN → COTTON 	
		TAFFETA → SYNTHETIC 			COTELINE → SYNTHETIC 			GEORGETTE → SYNTHETIC 	
		GABARDINE → SILK 			TWEED → SILK 			PORAL → SILK 	
		FLANO → SILK 							

1 Preparing buttonhole foot

Adjust the length of bar-tack.
Length of bar-tack varies depending on the material and position to be sewn.

Normal length is 0.5 cm — 1.0 cm.

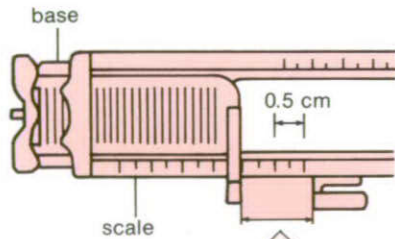

The available length for bar-tack is min. 0.5 cm and max. 3 cm.

scale
+ 0.2 cm

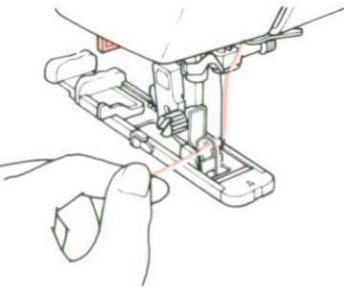

2 Attach buttonhole foot

Draw up lower thread.

3 Placing materials

1. Raise presser foot lifter.
2. Place material so that the opening of pocket is positioned at front.
3. Pressing the foot as shown below lower presser foot.

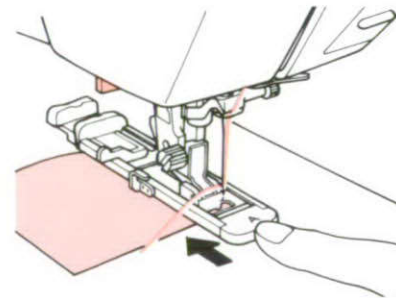

First needle position

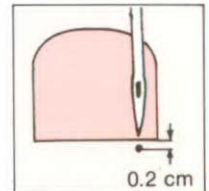



4 Draw out buttonhole lever

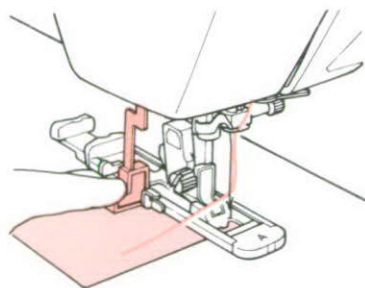

Buttonhole lever should be set at the back side of notch.

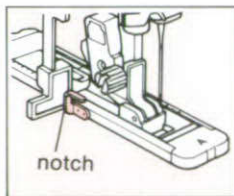

5 Start the machine

Hold the upper thread slightly.

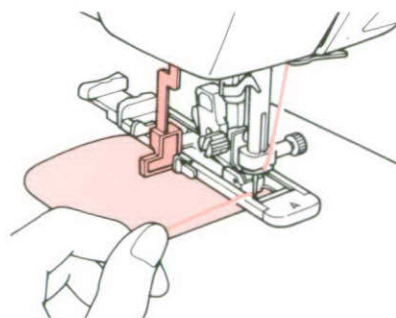

It stops automatically when finished.

• Bar-tack on thick materials

Place a piece of card-board as shown below.

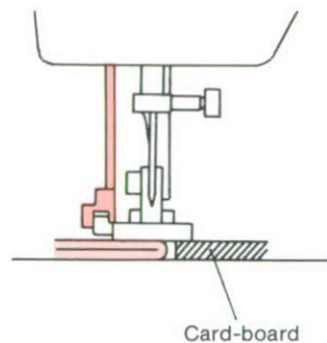

One point advice

Adjust the manual stitch length lever for narrow seam.

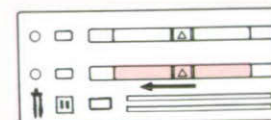



Button Sewing



Button Foot

SYNTHETIC



SILK



9-14
NEEDLE



Large



Small

Sewing speed is predetermined.

1 Preparation

1. Attach button sewing foot.
2. Drop feed dog down.

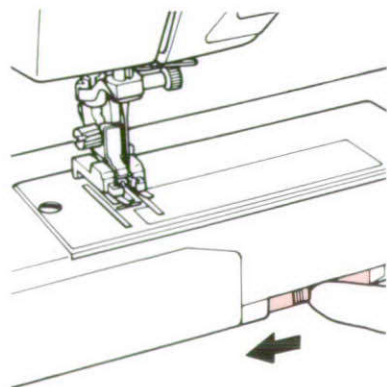

2 Fit button into the button foot

1. Raise presser foot lever and insert button as below.
2. Lower presser foot lever so that button is positioned at the correct place.

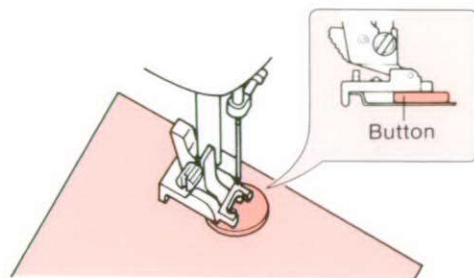

3 Start the machine

Make sure that needle enters into both holes of button without obstruction.

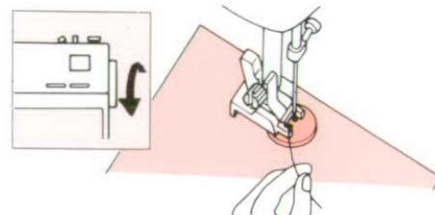

4 Tie the ends

1. Cut starting ends of upper and lower threads.
2. Pull end of lower thread so that end of upper thread is pull down to undersurface.
3. Tie both ends of threads.

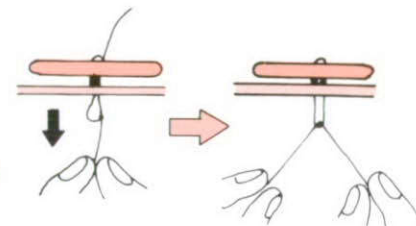

- * After fastening stitch, buttoning is finished automatically.
- * When button sewing is finished, make sure to raise feed dog up.

One point advice

- When sewing four hole button, sew front two holes first.

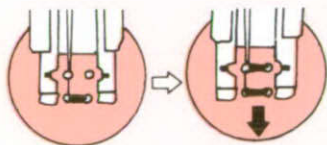

- For strong button fitting, repeat and sew twice.

VOICE MESSAGE

- * "Please change position of red knob to left to lower feed dog."
.... When you start button sewing without lowering feed dog.
- * "Please change position of red knob to raise feed dog."
... When you start general sewing without raising feed dog.

• Shank Button Sewing

1. Set front leg lever of button foot as below
2. Tie the ends
 - 1) Draw up both ends (start and final) of upper thread between button and fabric and make shank and tie as below.
 - 2) Tie both ends of lower thread at undersurface of fabric.

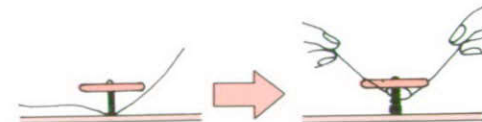
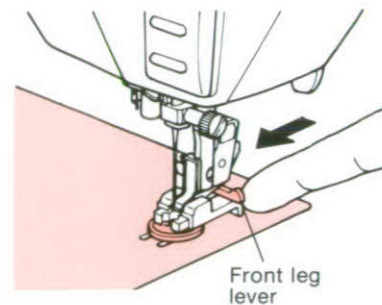

(Do not attempt for buttons with 4 holes.)



Blind Stitch



BLIND

NORMAL

BROAD → COTTON 60-80
 TAFFETA → SYNTHETIC 60-80
 GABARDINE → SILK 50-80
 FLANO →

11-14
NEEDLE



THINE

LAWN → COTTON 60-80
 GEORGETTE → SYNTHETIC 60-80
 PORAL → SILK 50-80

9-11
NEEDLE



THICK

DENIM → COTTON 40-50
 COTELINE → SYNTHETIC 50
 TWEED → SILK 50

11-16
NEEDLE



• For normal and thin fabrics

- 1 Fold fabric to make first hem, 1.5 cm (3/5 inch).
- 2 Fold fabric so that determined line is the top of work. Baste first hem at 1 cm (2/5 inch) from hem edge.

- 3 Make second hem which overlaps the first hem leaving 0.5 cm (1/5 inch) allowance from the top of work.

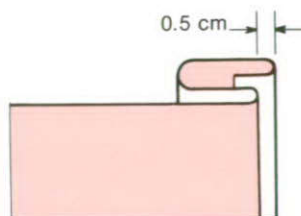
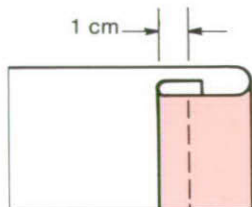
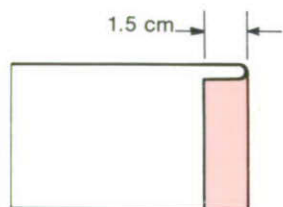

• For thick fabrics

1. Fold fabric so that determined line is the top of work.
 2. Baste hem at 1 cm (2/5 inch) from hem edge.
- 2 Make second hem which overlaps the first hem leaving 0.5 cm (1/5 inch) allowance from the top of work.

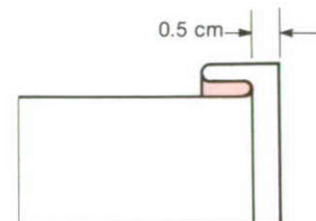
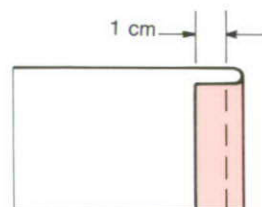

★ STRETCH FABRICS

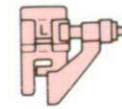

JERSEY

TRICOT



9—14
NEEDLE



•How to sew

1 Set fabric under foot

1. Turn the balance wheel so that needle touches the folded hem.
2. Adjust the foot so that foot guide touches the folded hem and lower the foot.

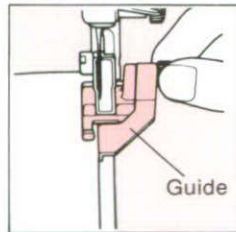
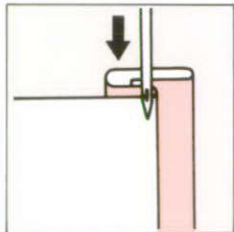

2 Start the machine

Holding the hem lightly with left hand, guide work along with the toe of foot.

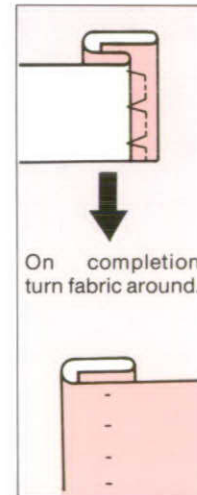
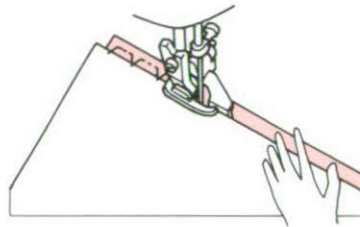

•When sewing on stretch fabric

Guide fabric with your right hand gently and depress the folded top with your left hand slightly.

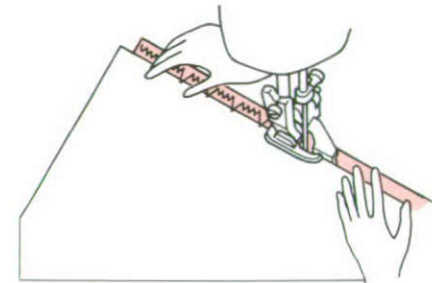



Scallop Stitch

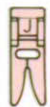

ZIGZAG



NORMAL

BROAD

COTTON

60 80

TAFFETA

SYNTHETIC

60 80

GABARDINE

SILK

50 80

FLANO



9-14
NEEDLE



In case of



1 Baste along the fabric edge.

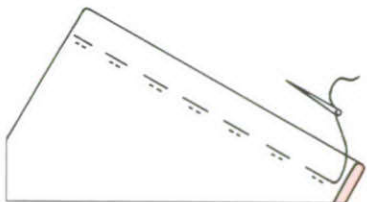

2 Stitch along the fabric edge.

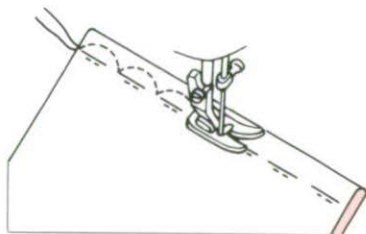

3 Trim the seam allowance

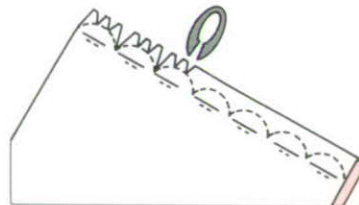

4 Turn the fabric to right side and press by ironing.

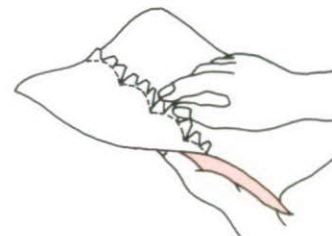

* Tie securely both threads at the beginning and end of seams.

* Be careful not to cut thread.

Finishing  In case of

1 Baste along the fabric edge.

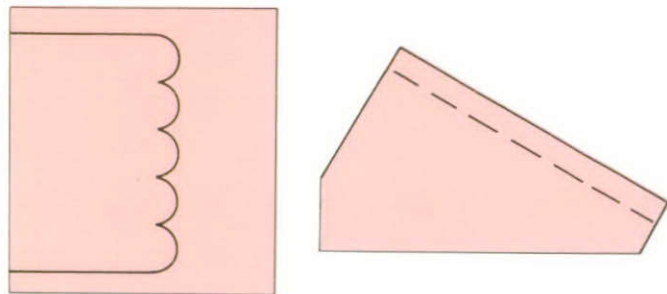

2 Stitch along the fabric edge.

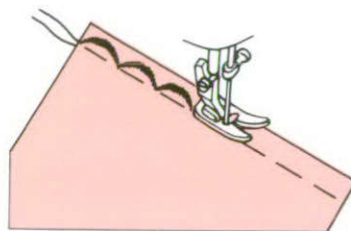

3 Trim the seam allowance and turn the fabric to right side and press by ironing.

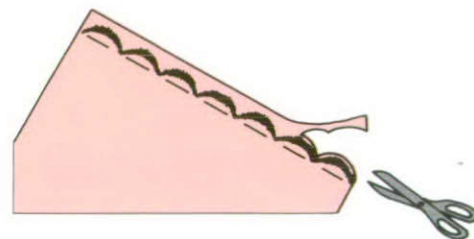

* Tie securely both threads at the beginning and end of seams.

* Be careful not to cut thread.



Oriental Seam Finish

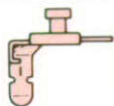

ZIPPER



BROAD → COTTON 60 80
TAFETA → SYNTHETIC 60 80
GABARDINE → SILK 50 80
FLANO →



9-14
NEEDLE



- 1** Stitch the bias strip to the seam edge, right sides together, at 0.5 cm (1/5 inch) away from the edge.

Ease strip when stitching the curves.

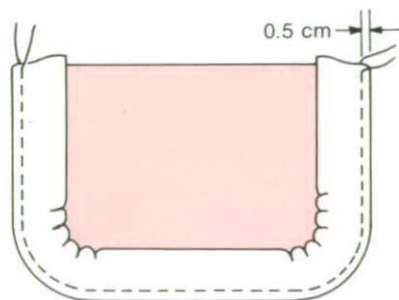

- 2** Wrap the strip around the seam edge to the wrong side.

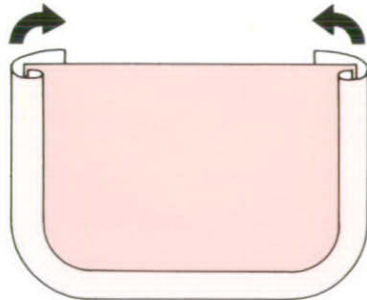

- 3** Wrap the strip at the back of work marking the hem 0.2 cm (1/10 inch) wider than right side hem. Iron and baste.

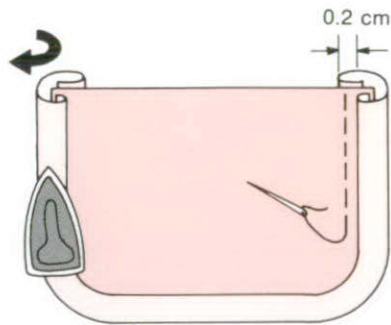

- 4** Secure by stitching-in-the-stitch on the right side.

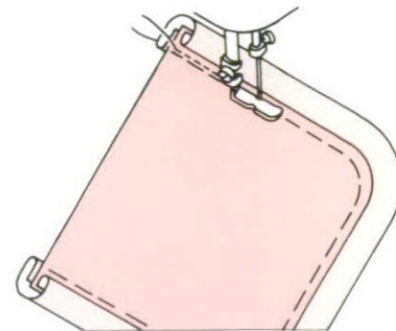

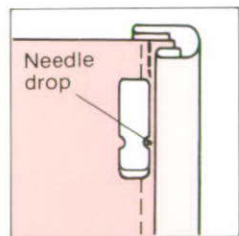

One point advice (bias strip)

1. Prepare the bias strips.

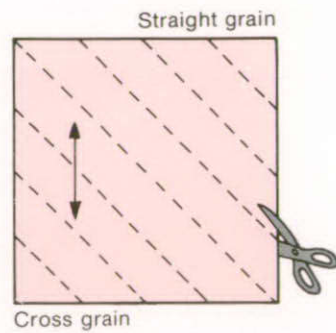

2. Join up these strips as shown below.

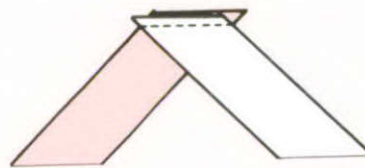

3. Trim the excess hem. Make the strip as long as your work requires.

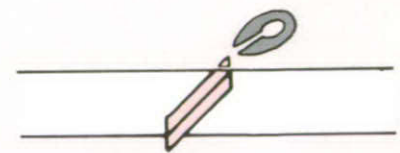



Fagoting

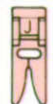

ZIGZAG



NORMAL

BROAD TAFFETA → SYNTHETIC
 GABARDINE → SILK
 FLANO



9-14 NEEDLE



1 Pressing

press on the seam allowance.

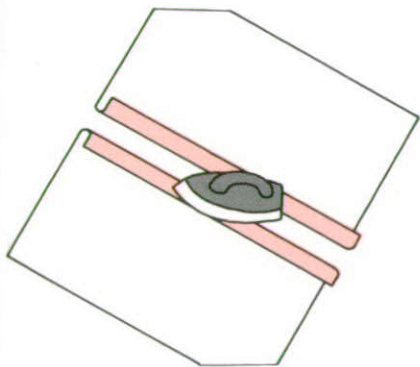

2 Basting

Apply thin paper to back of fabric and baste both together.

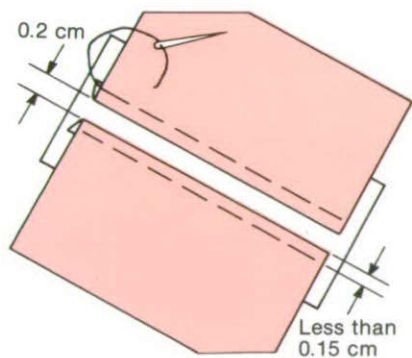

3 Adjust needle position

1. Turn the balance and find the position that first needle drop is 0.15 cm away from the edge.
2. Since first stitch (needle position) is into center, determine needle position by second stitch.

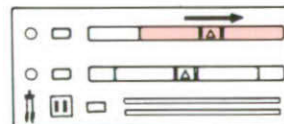

First needle drop

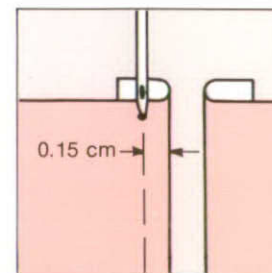

4 Stitch along the edge

Pull both threads slightly when starting.

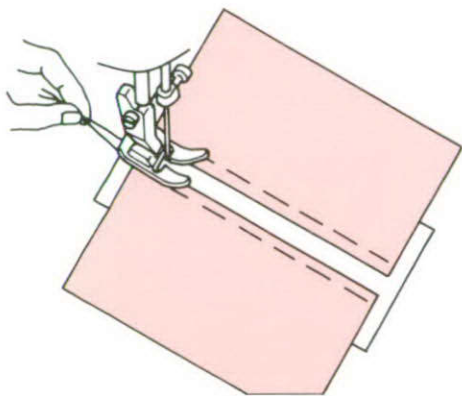

5 Sew together with paper

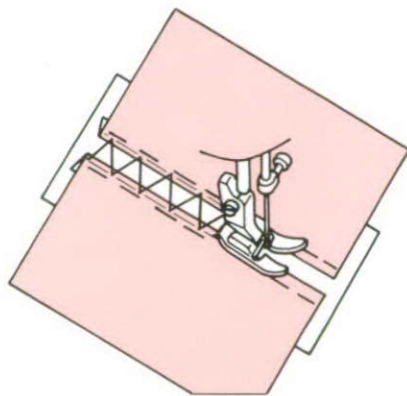

6 After sewing

1. Remove the bastings and the paper.
2. Tie knots at the beginning and end of seams on the reverse side.

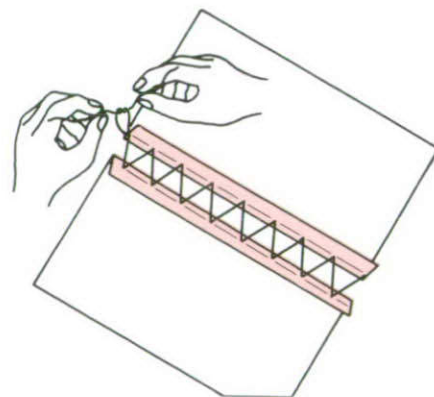



Pin Tucks



ZIPPER

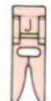

ZIGZAG



NORMAL

BROAD	→	COTTON	60-80
TAFFETA	→	SYNTHETIC	60-80
GABARDINE	→	SILK	50-80
FLANO	→		

9-14
NEEDLE



THINE

LAWN	→	COTTON	60-80
GEORGETTE	→	SYNTHETIC	60-80
PORAL	→	SILK	50-80

9-11
NEEDLE

1 Place ruler over the right side of fabric and mark the line with tailor's chalk.

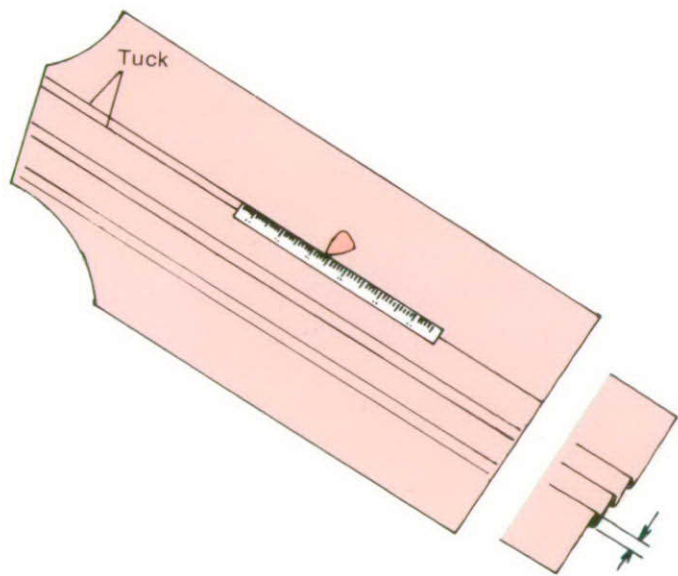

Depth of tucks x 2 = Folded

2 Press in the required folds.

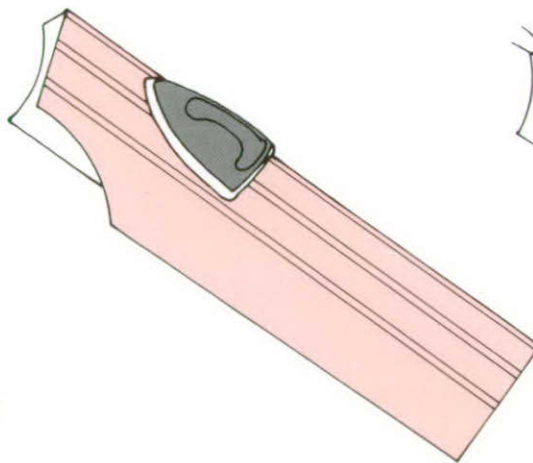

3 Stitch along the marked lines.

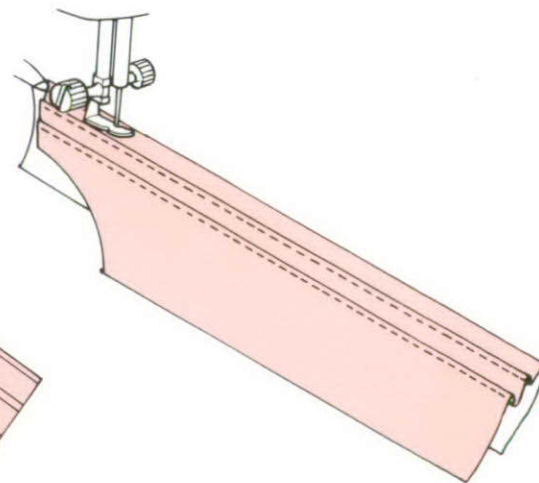

* Repeat stitching and pressing alternately to complete work.



Shell Tucks

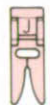

ZIGZAG



LAWN → COTTON 60-80
GEORGETTE → SYNTHETIC 60-80



9-11
NEEDLE



1 Adjusting thread tensions

Increase upper and lower tension from normal sewing.

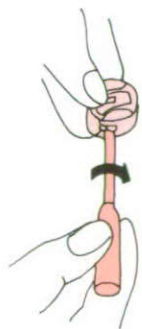

2 Stitch carefully, the right side stitch should sew just beyond fabric edge.

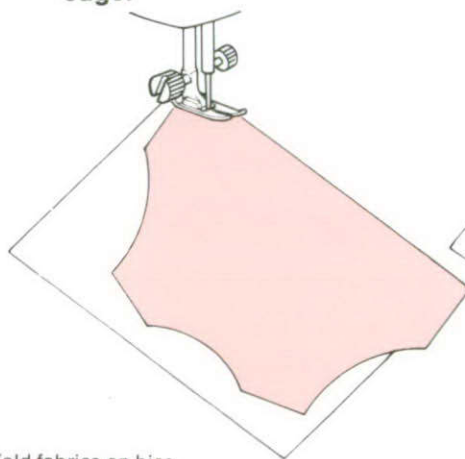

3 Repeat this procedure

Complete lines one at a time.

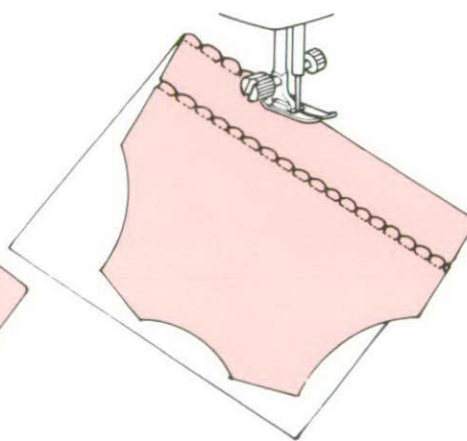

4 Reset thread tensions to normal.

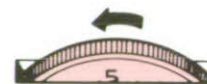

Fold fabrics on bias.

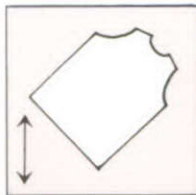

Right needle sews slightly beyond fabric edge.



Applique

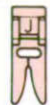

ZIGZAG



BROAD	→	COTTON	60-80
TAFFETA	→	SYNTHETIC	60-80
GABARDINE	→	SILK	50-80
FLANO	→		



11-14
NEEDLE



1 Glue supporting material on the wrong side of motif and press with the steam iron.

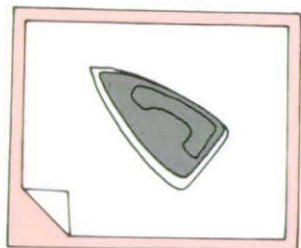

2 Trim along the motif.

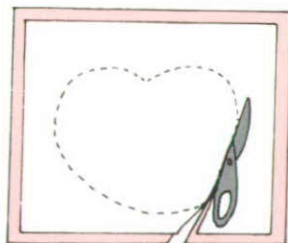

3 Apply the motif on the fabric.

Basting is recommended before stitching.

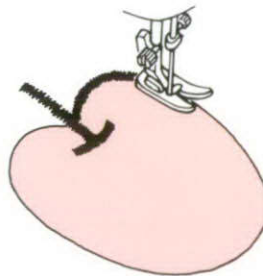

One point advice

- **Round corner sewing**

It is recommended sewing with shorter stitches so that seams appear fine.

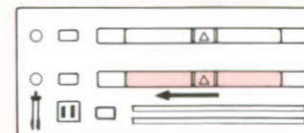



Patch Work

ZIGZAG

NORMAL

BROAD → COTTON 60-80
 TAFFETA → SYNTHETIC 60-80
 GABARDINE → SILK 50-80
 FLANO →

11-14 NEEDLE

THINE

LAWN → COTTON 60-80
 GEORGETTE → SYNTHETIC 60-80
 PORAL → SILK 50-80

9-11 NEEDLE

THICK

DENIM → COTTON 40-50
 TWEED → SILK 50

11-16 NEEDLE

1



2 Join two pieces.

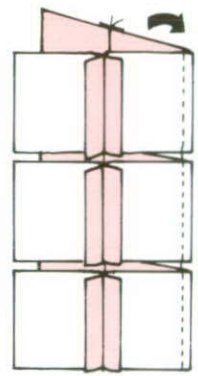

3 Join two pieces.

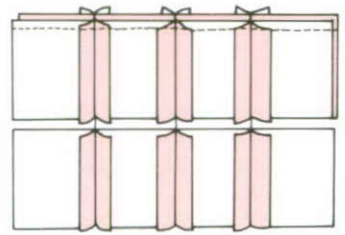

4 Stitch the folded trims with your favorite stitch pattern.

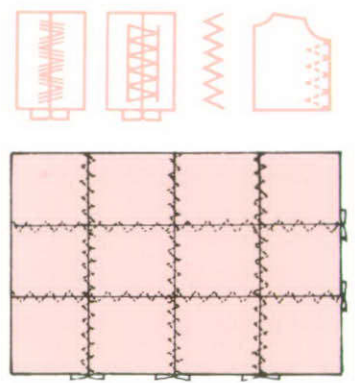

* The folded trim should be pressed with the iron.



Darning

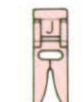

ZIGZAG



NORMAL

BROAD	→	COTTON	60 80
TAFFETA	→	SYNTHETIC	60 80
GABERDINE	→	SILK	50 80
FLANO	→		

11-14
NEEDLE



THICK

DENIM	→	COTTON	40 50
COTELINE	→	SYNTHETIC	50
TWEED	→	SILK	50

11-16
NEEDLE



- 1 Select zigzag stitch and set the zigzag width to zero at manual setting.

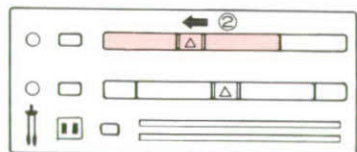

- 2 Lower the feed dog.

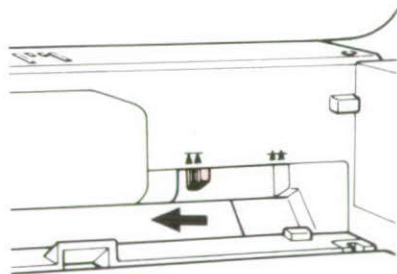

- 3 Raise the presser adjusting lever.

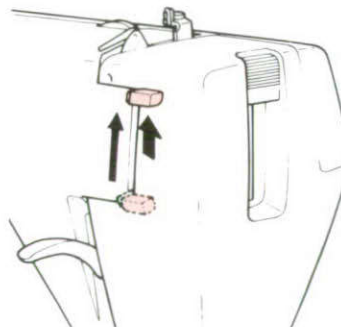

- 4 Place material and lower presser foot. Start sewing.
Guide materials with hand to complete the job.

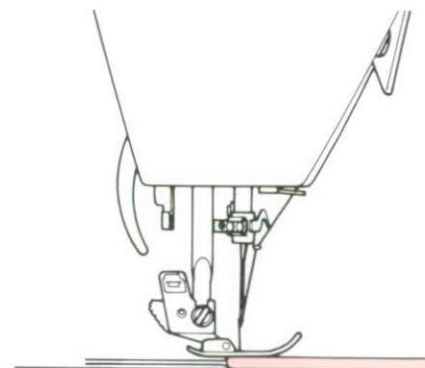



Some Hints to Know

★ PLACING THE FABRICS

- **Stitching thick and thin materials together**

Place thin fabric over thick fabric.

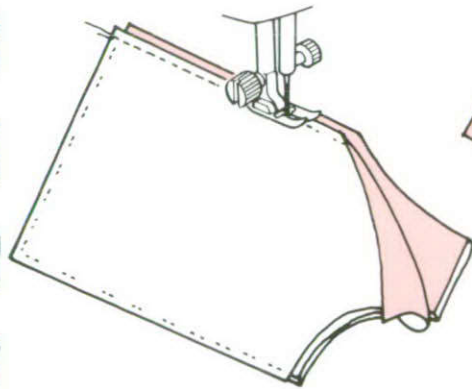

- **Stitching straight grain and bias together**

Place the bias on the straight grain.

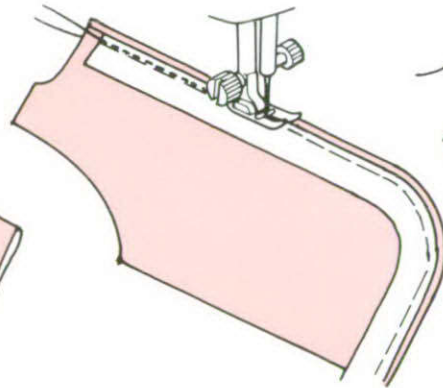

- **Stitching bulk fabric to flat fabric**

Place bulky fabric over the flat fabric.

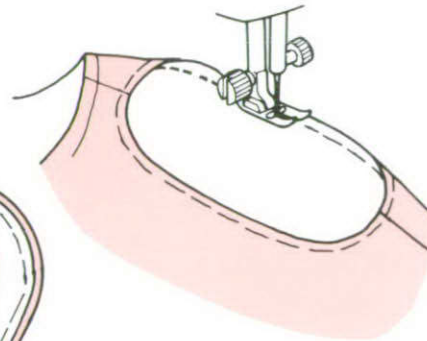

- **Stitching large pieces and small pieces**

Place small piece over large piece of fabric.

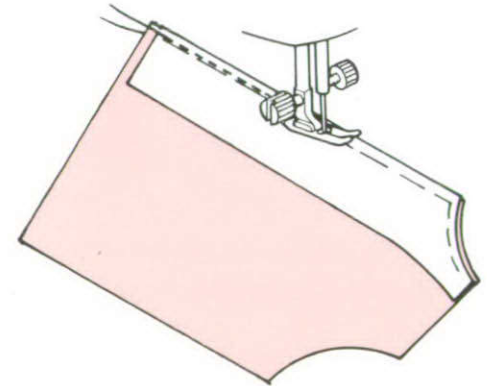

★ GUIDING THE FABRICS

• Normal fabrics

Hold the edge of fabric slightly with right hand and guide fabric with left hand.

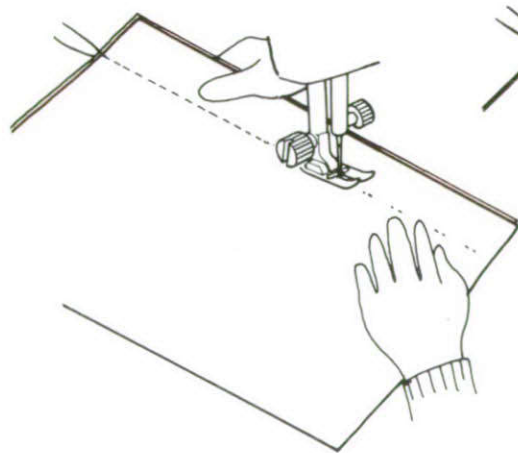

• Slippage and frayed fabrics

Hold fabrics firmly with both hands and feed for short distances.

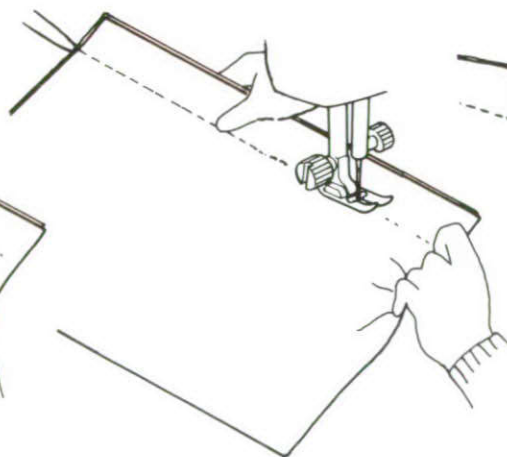

• Guiding downward

Hold fabric end with left hand and guide other end with right hand.

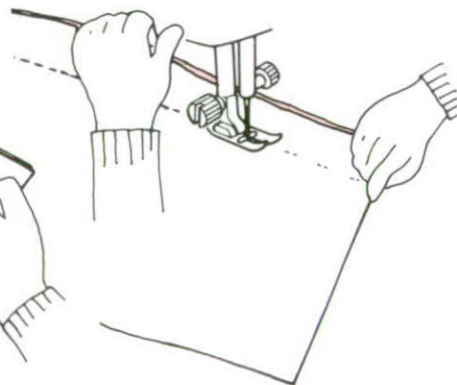

• Round corner sewing

Guide fabric from outside to inside.

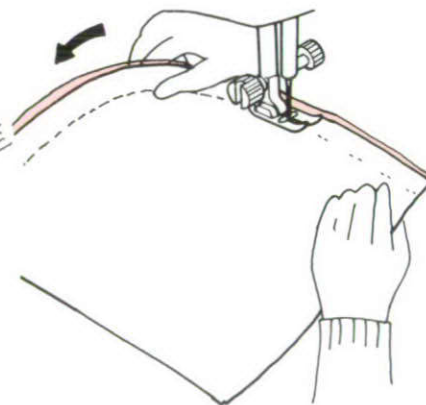



★ TOP STITCHING ENCLOSED SEAMS

• Top stitching enclosed seams

1. Turn fabric inside out and stitch as marked.
All other seam allowance layers should be trimmed slightly narrower.

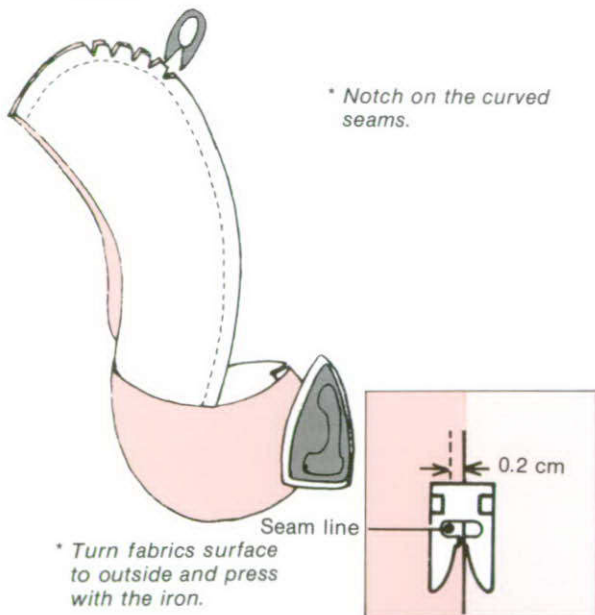

2. Start the machine, checking the seamline.

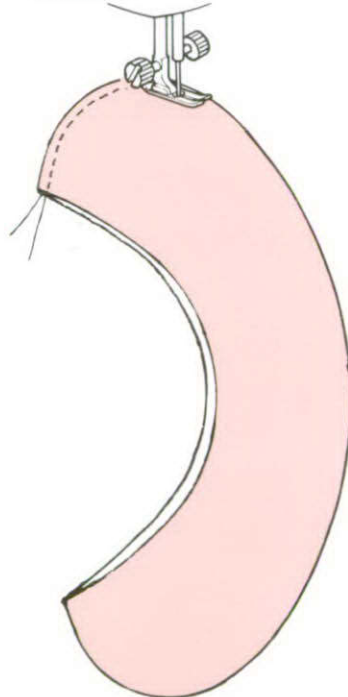

3. At the beginning and end of the seams, tie knots at the inside of fabrics.

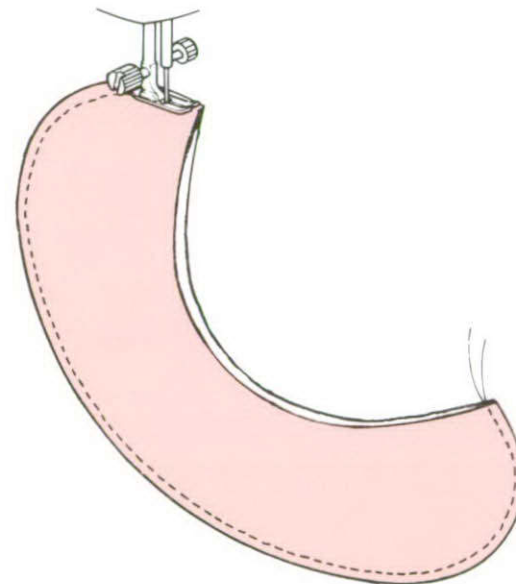



How to Stitch Over Awkward Areas

•Stitching on the collar

1. Attach thread loop at the edge of collar by 5 cm (2 inches).

2. Pull this loop towards back of machine, insert the work under the foot, taking care at tip of collar does not fall in the needle hole.

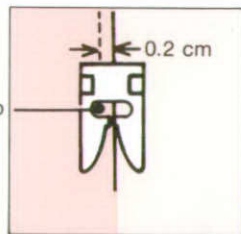
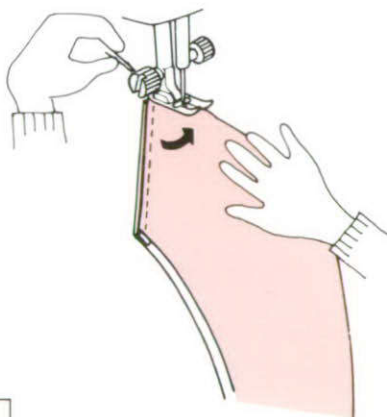
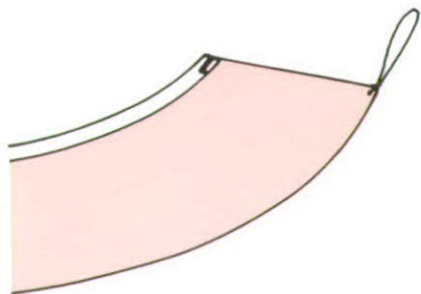

Needle drop

•Starting with thick materials

Insert the same thickness of fabric at the back of foot and guide your work under the toe of foot, pulling both threads backwards.

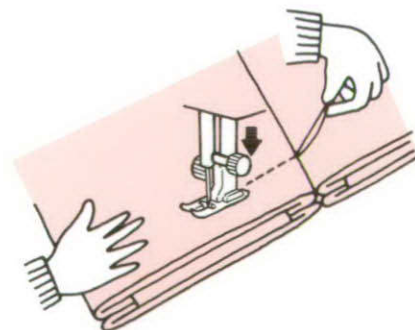
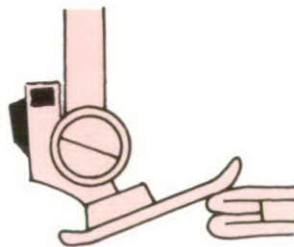

•Stitching over the hurdle

Stitch as illustrated.

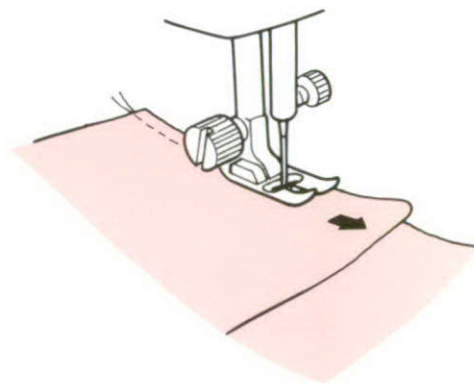

• **Stitching thin materials**

1. Baste along the seam edge.

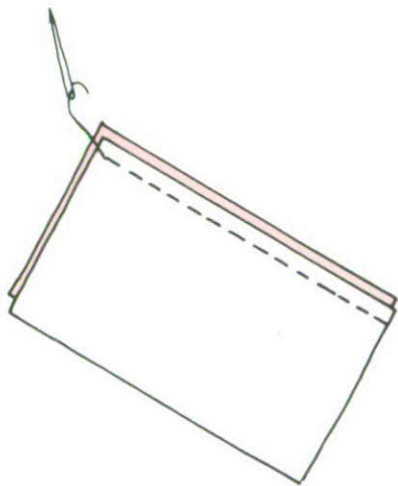

2. Apply thin paper under the fabrics and stitch together.

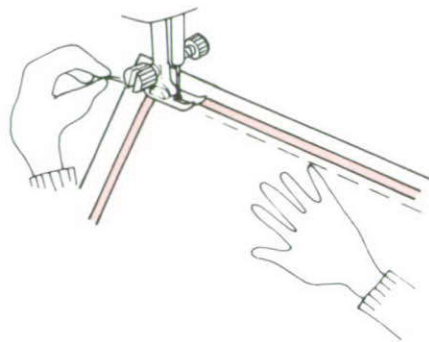

• **Stitching with big seam allowance**

Prepare seam-edge-using cardboard and sew along with this edge. This helps to obtain seam line and prevents fabric slippage.

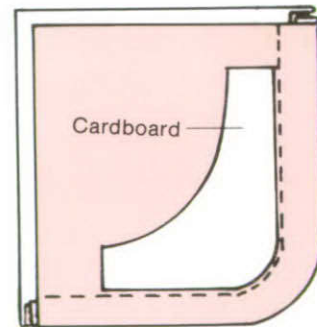
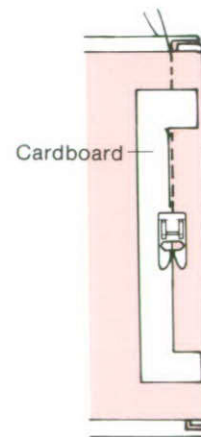



MEMORY



ZIGZAG (transparent)



BROAD → COTTON 50 80
 TAFFETA → SYNTHETIC 50 80
 GABARDINE → SILK 50 80
 FLANO →

Mem

9-14
NEEDLE

This machine can sew 100 patterns by programming pattern numbers.

- Change the pattern indicator panel as shown.

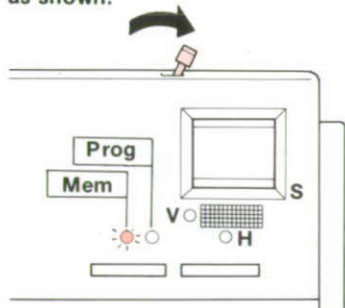

Note:

- When changing the pattern panel, memory patterns will be always chosen.
- When changing the pattern indication from utility stitch to memory stitch, loosen the upper thread tension slightly. On the other hand, when changing the pattern indication from memory stitch to utility stitch tighten the upper thread tension slightly.

- Two keys for input

- Ten key



Inputting pattern numbers.

- Joint key



Combination patterns from 00 to 46.

- Indicator panel



Indicating patterns numbers input by ten key.

*Memory Stitch NO. 00 - 99

A Patterns from 00 to 46 green can sew patterns one by one. Approx. 40 patterns can be combined.

Stitch length and width can not be adjusted.

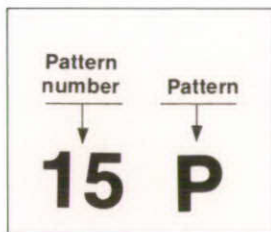

Presser foot N						
00	01	02	03	04	05	06
A	B	C	D	E	F	G
07	08	09	10	11	12	13
H	I	J	K	L	M	N
14	15	16	17	18	19	20
O	P	Q	R	S	T	U
21	22	23	24	25	26	27
V	W	X	Y	Z	.	?
28	29	30	31	32	33	34
!	—	0	1	2	3	4
35	36	37	38	39	40	41
5	6	7	8	9	..	~
42	43	44	45	46		
&	Ç	Ø	Å	Æ		

B Patterns from 47 to 67 yellow can not be combined.
Stitch length and width can not be adjusted.

C Patterns from 68 to 99 blue can not be combined, but
stitch length and width is adjustable.

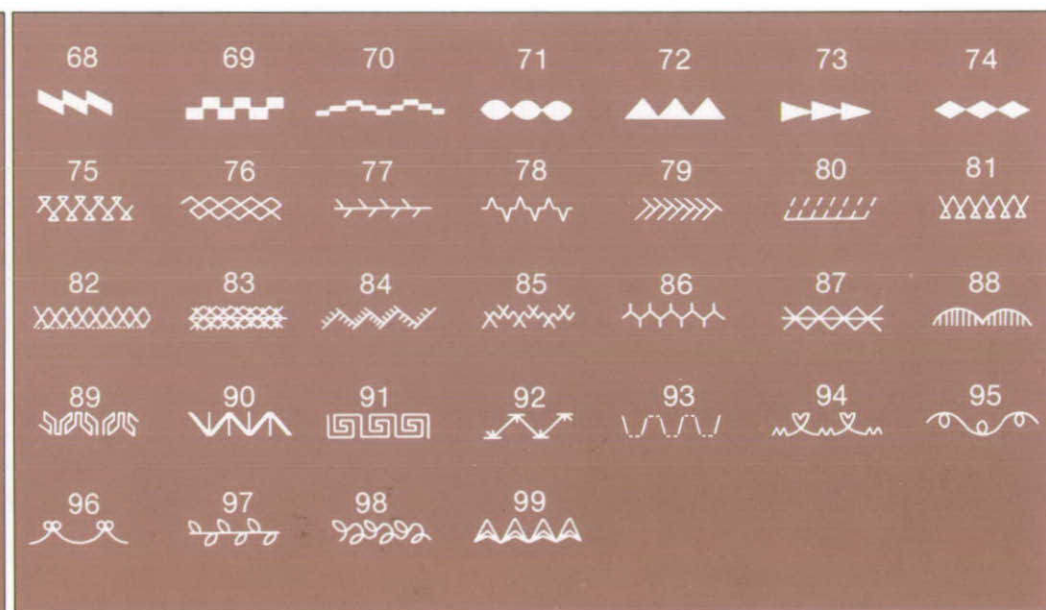
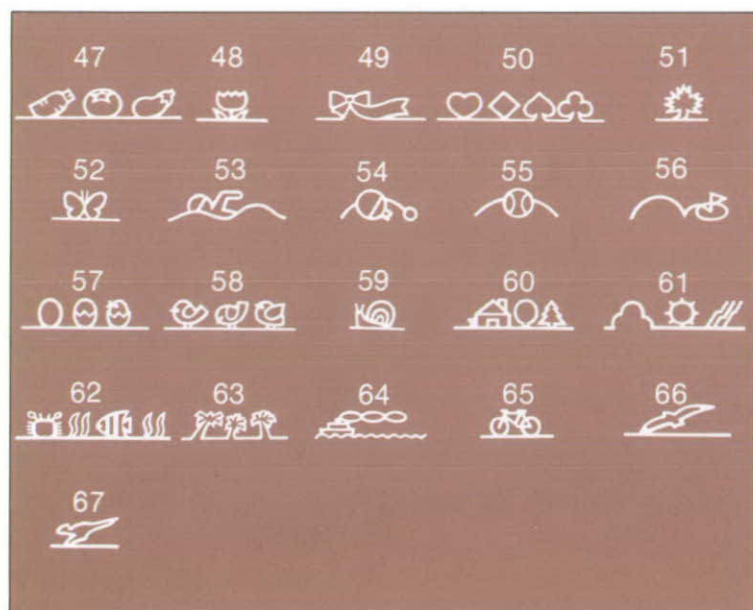

Example

^{*} 1 Select desired patterns.



2 Check pattern number.



3 Input pattern numbers.



4 Start sewing.

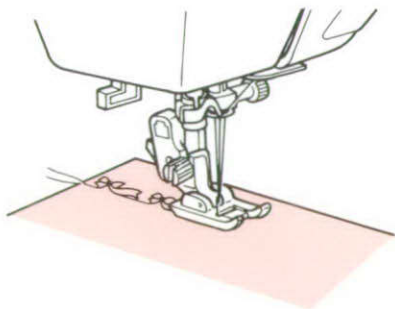

• **Changing the pattern**
Input pattern numbers again.

Finish

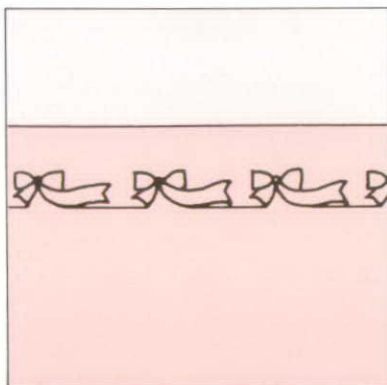

When inputting error is made,
input again from the beginning.

Note:
You are requested to input two
figures.

Group A combination

- ★
1 Select desired patterns. 2 Check pattern numbers.



06 + 14 + 14 + 03
G O O D

Finish

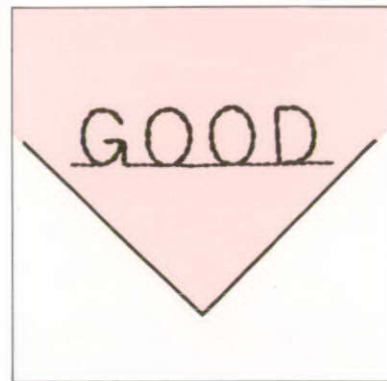

- 3 Input pattern numbers.

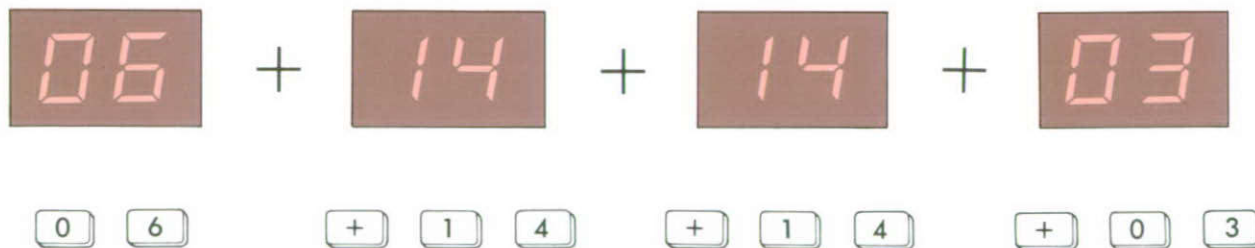

- 4 Start sewing.

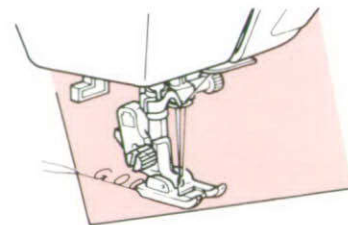

One point advice

- Stitch length and width for patterns from 68 to 99 (blue) can be adjusted as follows by setting stitch length and width control lever at manual.



N. 88



N. 71



N. 92

- When the shape of patterns becomes wrong, it is required to adjust the stitch length fine adjustment dial (see page 4) as shown below.

CORRECT PATTERN

1. When each pattern comes close...

2. When each pattern comes apart ...

S & E

S & E

S & E

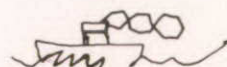

ADJUSTMENT

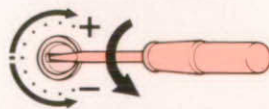
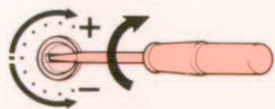

ERROR MESSAGE

"Please check instruction book."

Input correct two figures again.

"Memory capacity full. Please check instruction book."

When combining 47 patterns of group A, over 40 patterns can be combined and numbers of pattern are depending on the stitch numbers of monograms and figures among group A.

"This pattern combination is not acceptable. Refer to instruction book."

Patterns of group B and C can not be combined.

★ When you start sewing without inputting pattern numbers, machine sews former pattern numbers.

★ Memorized data will be kept for a whole day at least even if machine is switched off.

However the straight stitch will be automatically selected after the memory keeping time.

PATTERN

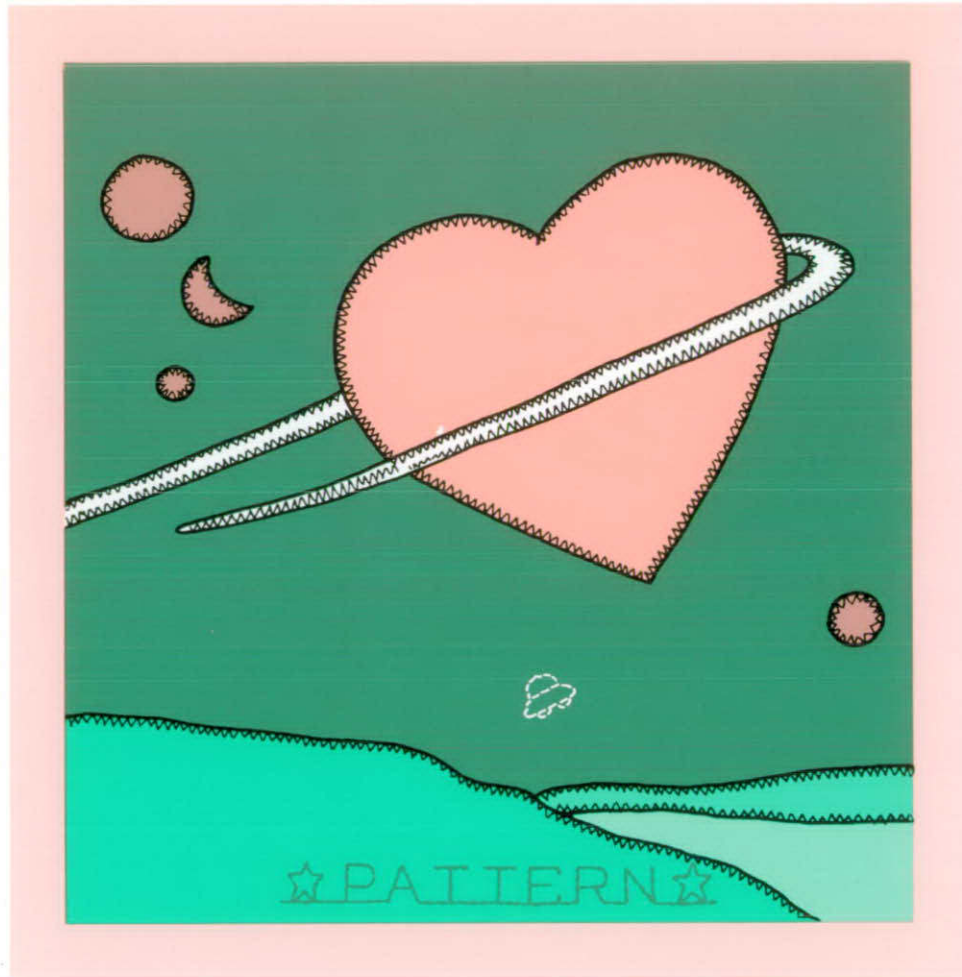



★ When designing your own patterns, please refer to the memory patterns.

Basic sewing movement

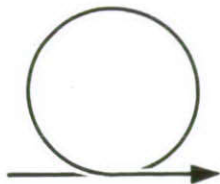

★ Designing your own patterns

- Patterns should give continuous sewing.

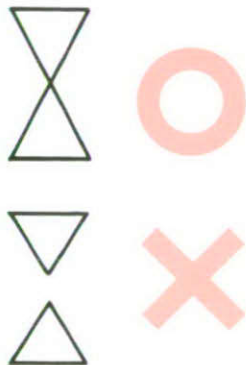

★ SEW CONTINUOUS STITCHES

- Stitch width should be the same at the beginning and the end of patterns.

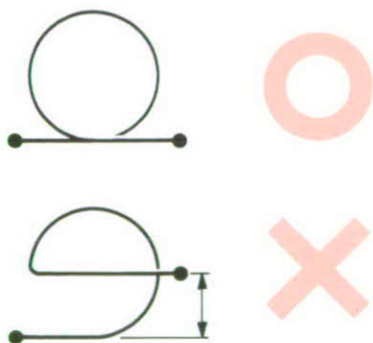

- Maximum patterns length is 7 mm.

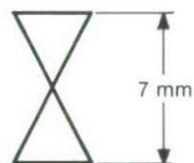

- When wishing to sew thick lines ...

Use like triple stretch stitch.

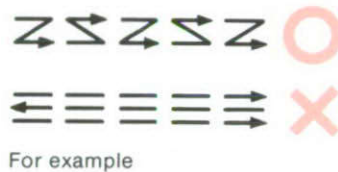

- Patterns should start from the left to the right.

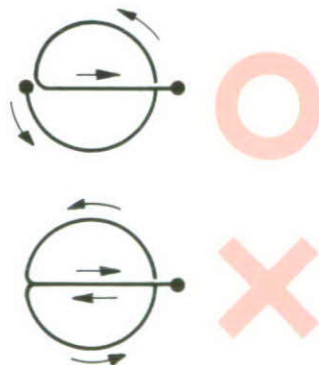

- Sewing patterns with satin stitch.

Sew patterns to the right.

For example



- Patterns should have distance between them as shown below.

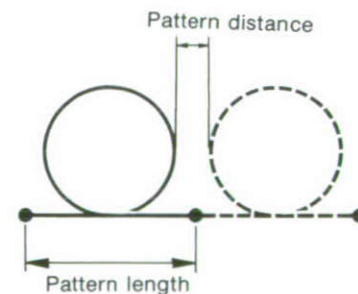



How to produce pattern data

★ How to input the pattern

1 The machine will memorize various patterns by input data (numbers) and not by pattern shape itself.

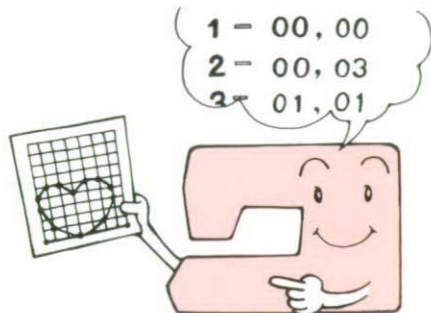

* Your patterns will be also memorized by numbers.

2 Use program sheet in order to put pattern shape into numbers.

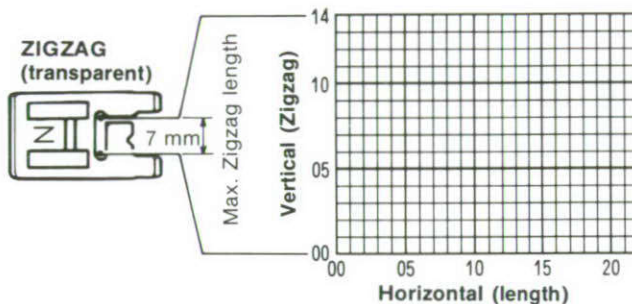

** The size of one frame of the program sheet is

Length 0.4 mm
Width 0.5 mm

ONE POINT ADVICE

The stitch length is very important for finishing patterns beautifully. Please note following points.

1. Produce same size stitches.
2. Most suitable range of the needle movement is between 2-5 frame (1-2 mm).

★ Design patterns in order.

For example

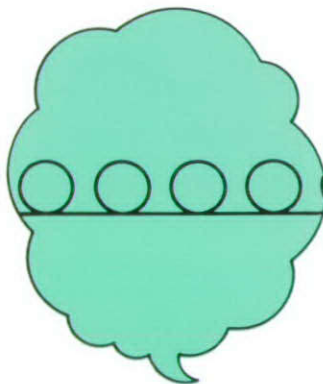

1 Design patterns on the program sheet.

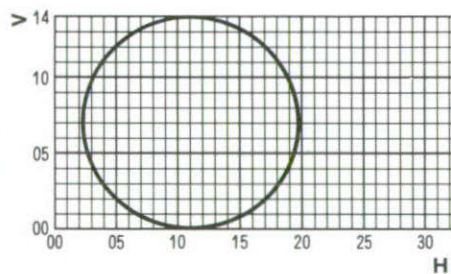

2 Take a distance between each patterns.

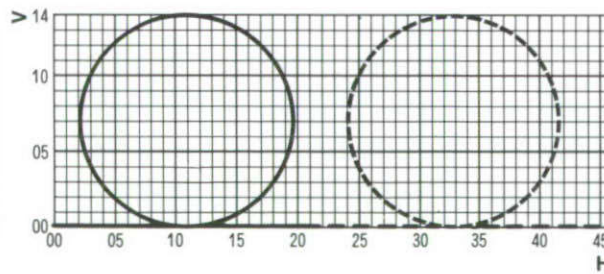

3 Put the point as below at the crossing where the needle points.

* The movable range of the needle within 6 frames to the horizontal direction.

** The point number should be within 50.

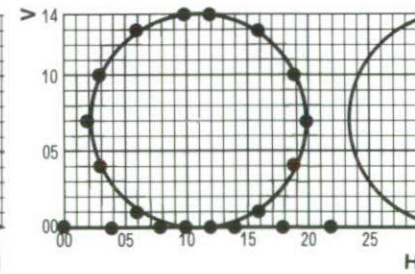

4 According to the pattern shape, in-put stitch number.

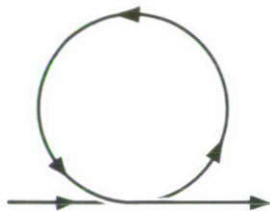

5 Mark the point on data sheet.

How to read the point.

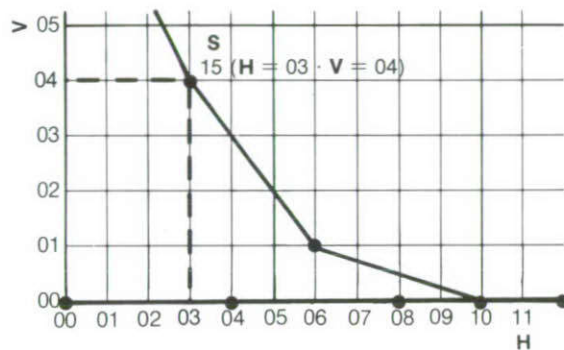

S	1	2	3	4	5	6	7	8	9	10
H	00	04	08	12	16	19	20	19	16	12
V	00	00	00	00	01	04	07	10	13	14

S	11	12	13	14	15	16	17	18	19	20
H	10	06	03	02	03	06	10	14	18	22
V	14	13	10	07	04	01	00	00	00	00

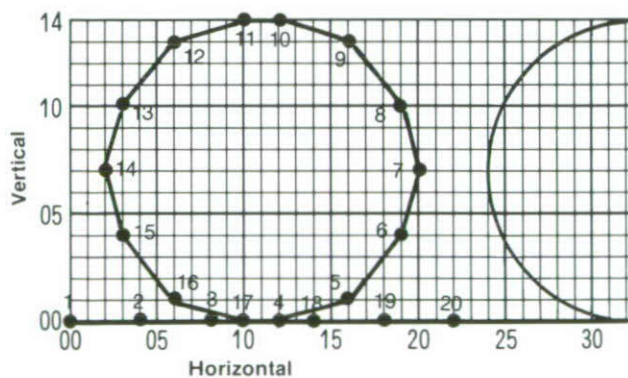

Note:
S .. STITCH NUMBER
V .. Vertical data
H .. Horizontal data

ONE POINT ADVICE

With different distances between patterns, you can produce various additional patterns.

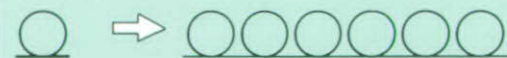



How to Input



BROAD
TAFETA
GABERDINE
FLANO

COTTON
SYNTHETIC
SILK



★ How to set

Press pattern selection button as illustrated right and check LED sign of "prog" is on.

★ Memorize the patterns.

• Programming

- Start and End key



▶ key ... Start input.
▶ key ... End input.

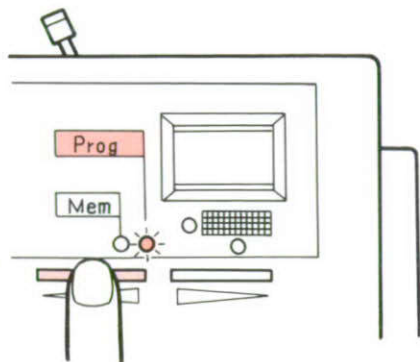

• Ten key



Key for data input.

• Indication panel (LED indication)

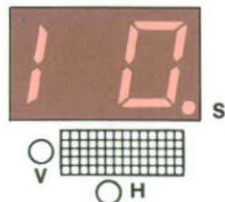

S (Panel) .. Indicate stitch numbers.
H .. Input horizontal data.
V .. Input vertical data.

Input preceding data.

S	1	2	3	4	5	6	7	8	9	10
H	00	04	08	12	16	19	20	19	16	12
V	00	00	00	00	01	04	07	10	13	14

S	11	12	13	14	15	16	17	18	19	20
H	10	06	03	02	03	06	10	14	18	22
V	14	13	10	07	04	01	00	00	00	00

1 Push start key.

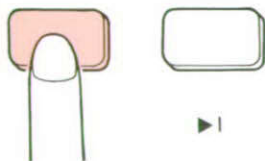

2 Input data with ten key.

Input the number for the first stitch.

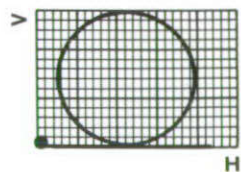

S	1
H	00
V	00

Note:
Input data from horizontal to vertical.



Input the number for the second stitch.

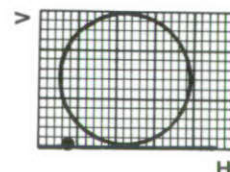

S	2
H	04
V	00

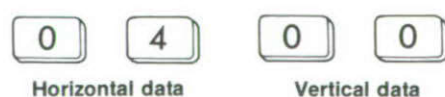

ONE POINT ADVICE

- When setting stitch length and width lever by adjusting them, various shapes of patterns can be sewn.

* Zigzag width control lever.

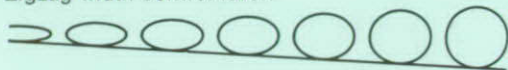

to the left ←



** Stitch length control lever.

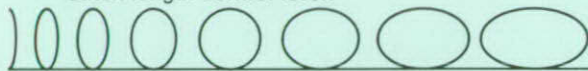

to the left ← to the right →



ERROR MESSAGE

"Please check instruction book."

- When inputting horizontal data ...

Horizontal data exceeds 6 frames for the movable range of the needle.

- When inputting Vertical data ...

Vertical data exceeds 14 frames for the movable range of the needle.

"Memory capacity full. Please check instruction book."

Stitch number exceeds 50 stitches.

- ★ When you start sewing without inputting pattern numbers, machine will sew former pattern numbers.

Input the number for the third stitch.
Input the numbers for 4th thru. 20th stitches.

3 Push end key. 4 Start sewing.

★ When inputting wrong data, push Start key, and start inputting from the beginning.

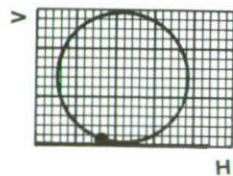

S	3
H	08
V	00

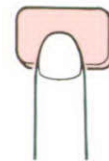
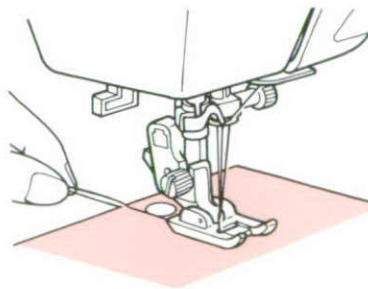
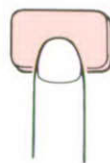

Horizontal data



Vertical data

** Sew test stitches before start sewing.

Finish

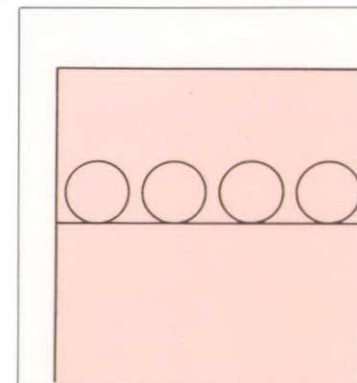

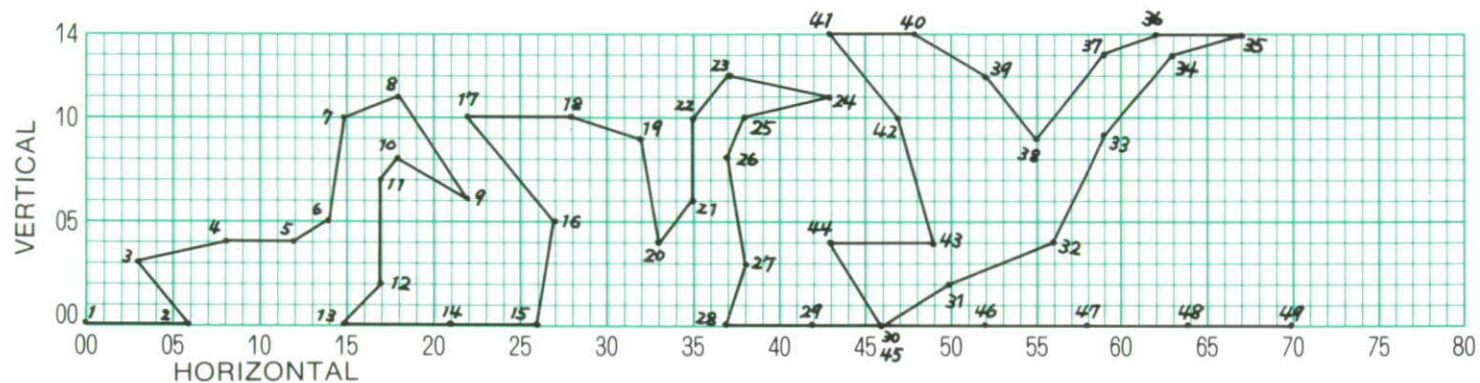

PROGRAM SHEET

Let's start the programming
for your own designs.



S	1	2	3	4	5	6	7	8	9	10	11	12	13	14	15	16	17	18	19	20	21	22	23	24	25
H	00	06	03	08	12	14	15	18	22	18	17	17	16	21	26	27	22	28	32	33	35	35	37	43	38
V	00	00	03	04	04	05	10	11	06	08	07	02	00	00	00	05	10	10	09	04	06	10	12	11	10
S	26	27	28	29	30	31	32	33	34	35	36	37	38	39	40	41	42	43	44	45	46	47	48	49	50
H	37	38	37	42	46	50	56	59	63	67	62	59	55	52	48	43	47	49	43	45	52	58	64	70	
V	08	03	00	00	00	02	04	10	13	14	14	13	09	12	14	14	10	04	04	00	00	00	00	00	

										S	1	2	3	4	5	6	7	8	9	10	11	12	13	14	15	16	17	18	19	20
										H	00	06	10	14	19	24	26	26	25	24	25	26	24	22	24	24	22	16	13	10
										V	00	00	00	00	01	04	07	09	09	08	09	12	12	10	12	14	14	08	07	08
21	22	23	24	25	26	27	28	29	30	31	32	33	34	35	36	37	38	39	40	41	42	43	44	45	46	47	48	49	50	
11	10	11	10	08	07	04	04	06	07	07	06	06	04	01	04	05	09	14	20	26	32									
09	10	11	13	12	14	13	11	10	11	10	11	10	11	08	08	04	01	00	00	00	00									

										S	1	2	3	4	5	6	7	8	9	10	11	12	13	14	15	16	17	18	19	20
										H	00	03	08	14	20	25	28	33	39	39	42	44	50	50	56	56	60	63	63	66
										V	00	07	12	14	12	07	00	05	07	03	03	06	05	00	00	05	05	06	07	07
21	22	23	24	25	26	27	28	29	30	31	32	33	34	35	36	37	38	39	40	41	42	43	44	45	46	47	48	49	50	
66	66	66	66	63	63	60	60	60	56	56	50	50	44	42	39	39	39	42	44	50	50	56	62	68	74					
12	07	02	07	07	08	09	05	09	09	14	14	09	08	11	11	07	03	03	06	05	00	00	00	00						

										S	1	2	3	4	5	6	7	8	9	10	11	12	13	14	15	16	17	18	19	20
										H	00	06	12	18	24	30	32	33	32	32	33	35	35	37	35	32	30	30	29	26
										V	00	00	00	00	00	00	01	03	07	10	12	11	08	12	14	14	11	05	03	08
21	22	23	24	25	26	27	28	29	30	31	32	33	34	35	36	37	38	39	40	41	42	43	44	45	46	47	48	49	50	
24	18	13	14	10	12	08	11	07	11	06	10	05	10	14	19	24	22	17	22	24	19	24	30	36	42					
10	13	14	12	11	10	08	08	06	05	03	02	00	02	00	00	01	06	10	06	01	00	00	00	00						

										S	1	2	3	4	5	6	7	8	9	10	11	12	13	14	15	16	17	18	19	20
										H	00	06	07	04	03	05	09	13	16	16	14	10	07	09	06	12	17	18	16	14
										V	00	00	02	03	07	11	13	14	12	08	04	02	02	06	00	00	00	02	02	04
21	22	23	24	25	26	27	28	29	30	31	32	33	34	35	36	37	37	39	40	41	42	43	44	45	46	47	48	49	50	
16	19	23	24	23	20	18	19	17	22	27	28	26	24	24	26	29	34	36	36	34	31	28	30	28	27	33	39			
08	09	09	07	03	02	02	04	00	00	00	02	02	04	08	12	14	14	11	07	04	02	02	05	02	00	00				

										S	1	2	3	4	5	6	7	8	9	10	11	12	13	14	15	16	17	18	19	20
										H	00	06	12	12	12	07	03	01	07	07	07	01	06	12	12	18	18	18	18	18
										V	00	00	00	07	14	13	10	06	06	09	06	06	02	00	07	07	14	07	00	07
21	22	23	24	25	26	27	28	29	30	31	32	33	34	35	36	37	38	39	40	41	42	43	44	45	46	47	48	49	50	
24	24	24	24	24	30	30	30	30	30	34	40	40	40	34	30	24	18	12	12	18	24	30	36	42	48	54				
07	12	07	02	07	07	11	07	03	07	07	02	07	14	07	07	07	07	07	00	00	00	00	00	00						

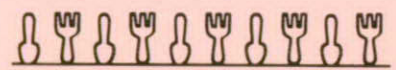
										S	1	2	3	4	5	6	7	8	9	10	11	12	13	14	15	16	17	18	19	20
										H	00	05	09	11	11	08	10	08	06	04	06	03	03	05	09	14	20	22	24	22
										V	00	00	00	03	05	06	12	14	14	12	06	05	03	00	00	00	00	00	02	08
21	22	23	24	25	26	27	28	29	30	31	32	33	34	35	36	37	38	39	40	41	42	43	44	45	46	47	48	49	50	
26	26	25	24	22	22	21	20	20	18	17	16	16	20	18	20	22	28													
09	14	14	10	10	13	14	13	10	10	14	14	09	08	02	00	00														

										S	1	2	3	4	5	6	7	8	9	10	11	12	13	14	15	16	17	18	19	20
										H	00	06	12	18	21	22	20	17	14	12	10	07	04	02	03	06	12	17	22	27
										V	00	00	00	03	06	10	13	14	13	10	13	14	13	10	06	03	00	00	00	00
21	22	23	24	25	26	27	28	29	30	31	32	33	34	35	36	37	38	39	40	41	42	43	44	45	46	47	48	49	50	
32	37	39	35	37	35	32	29	27	28	31	37	39	45	48	49	47	44	41	39	37	41	39	44	49	54					
00	00	04	07	10	13	14	13	10	06	03	00	00	03	06	10	13	14	13	10	07	04	00	00	00						

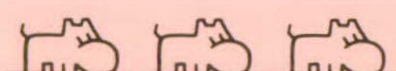
										S	1	2	3	4	5	6	7	8	9	10	11	12	13	14	15	16	17	18	19	20
										H	00	06	12	12	15	15	19	19	19	23	24	28	33	37	39	39	36	32	30	28
										V	00	00	00	03	03	00	00	03	00	00	03	00	00	01	04	07	09	10	09	11
21	22	23	24	25	26	27	28	29	30	31	32	33	34	35	36	37	38	39	40	41	42	43	44	45	46	47	48	49	50	
30	27	25	27	25	30	32	29	27	26	23	22	22	20	15	10	07	05	06	05	07	07	08	14	19	25	31	37	43		
09	08	10	08	07	09	10	14	14	12	12	14	14	10	10	10	09	11	13	11	09	04	00	00	00	00	00	00			

										S	1	2	3	4	5	6	7	8	9	10	11	12	13	14	15	16	17	18	19	20		
										H	00	02	04	07	11	16	19	23	26	28	29	29	28	26	23	20	17	15	14	14		
										V	00	05	08	11	13	14	14	13	12	10	08	05	03	01	00	00	01	03	05	08		
21	22	23	24	25	26	27	28	29	30	31	32	33	34	35	36	37	38	39	40	41	42	43	44	45	46	47	48	49	50			
15	17	20	24	27	32	36	39	41	43																							
10	12	13	14	14	13	11	08	05	00																							

										S	1	2	3	4	5	6	7	8	9	10	11	12	13	14	15	16	17	18	19	20							
										H	00	02	04	06	04	02	00	06	12	06	12																
										V	14	09	04	00	04	09	14	11	14	11	14																
21	22	23	24	25	26	27	28	29	30	31	32	33	34	35	36	37	38	39	40	41	42	43	44	45	46	47	48	49	50								

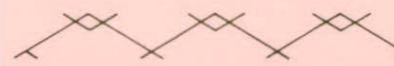
										S	1	2	3	4	5	6	7	8	9	10	11	12	13	14	15	16	17	18	19	20							
										H	06	00	06	12	06	12	16	22	16	22	28	22	28	34	28	34	40	34	40	44							
										V	03	00	03	00	03	06	08	11	14	11	14	11	08	11	14	11	14	11	14	11	08	06					
21	22	23	24	25	26	27	28	29	30	31	32	33	34	35	36	37	38	39	40	41	42	43	44	45	46	47	48	49	50								
50																																					
03																																					

										S	1	2	3	4	5	6	7	8	9	10	11	12	13	14	15	16	17	18	19	20							
										H	04	04	04	07	07	07	10	10	10	14	10	07	04	00	04	07	10	14	18	18							
										V	07	03	07	07	00	07	07	03	07	07	03	00	03	07	11	14	11	07	07	11							
21	22	23	24	25	26	27	28	29	30	31	32	33	34	35	36	37	38	39	40	41	42	43	44	45	46	47	48	49	50								
18	21	21	21	24	24	24	28	24	21	18	14	18	21	24	28																						
07	07	14	07	07	11	07	07	11	14	11	07	03	00	03	07																						

									S	1	2	3	4	5	6	7	8	9	10	11	12	13	14	15	16	17	18	19	20
									H	00	05	11	15	10	08	05	08	10	15	19	15	12	15	20	22	25	22	20	15
									V	14	14	14	08	06	05	08	11	10	08	03	00	03	08	10	11	08	05	06	08
21	22	23	24	25	26	27	28	29	30	31	32	33	34	35	36	37	38	39	40	41	42	43	44	45	46	47	48	49	50
19	25	30	35																										
14	14	14	14																										

									S	1	2	3	4	5	6	7	8	9	10	11	12	13	14	15	16	17	18	19	20
									H	00	00	00	06	11	14	17	22	17	14	11	11	11	11	11	11	11	08	05	00
									V	10	14	10	12	14	11	08	03	08	11	14	09	04	00	04	09	14	11	08	03
21	22	23	24	25	26	27	28	29	30	31	32	33	34	35	36	37	38	39	40	41	42	43	44	45	46	47	48	49	50
05	08	11	16	22																									
08	11	14	12	10																									

									S	1	2	3	4	5	6	7	8	9	10	11	12	13	14	15	16	17	18	19	20
									H	00	02	04	06	07	08	09	10	11	12	13	14	15	16	17	18	19	20	22	24
									V	00	04	09	14	10	14	09	14	08	14	07	14	08	14	09	14	10	14	09	04
21	22	23	24	25	26	27	28	29	30	31	32	33	34	35	36	37	38	39	40	41	42	43	44	45	46	47	48	49	50
26																													
00																													

									S	1	2	3	4	5	6	7	8	9	10	11	12	13	14	15	16	17	18	19	20
									H	00	04	07	10	14	15	16	17	18	19	20	21	22	23	24	25	26	27	28	29
									V	14	10	07	10	14	12	14	09	14	06	14	03	14	00	14	03	14	06	14	09
21	22	23	24	25	26	27	28	29	30	31	32	33	34	35	36	37	38	39	40	41	42	43	44	45	46	47	48	49	50
30	31	32																											
14	12	14																											



S	1	2	3	4	5	6	7	8	9	10	11	12	13	14	15	16	17	18	19	20	21	22	23	24	25
H																									
V																									
S	26	27	28	29	30	31	32	33	34	35	36	37	38	39	40	41	42	43	44	45	46	47	48	49	50
H																									
V																									

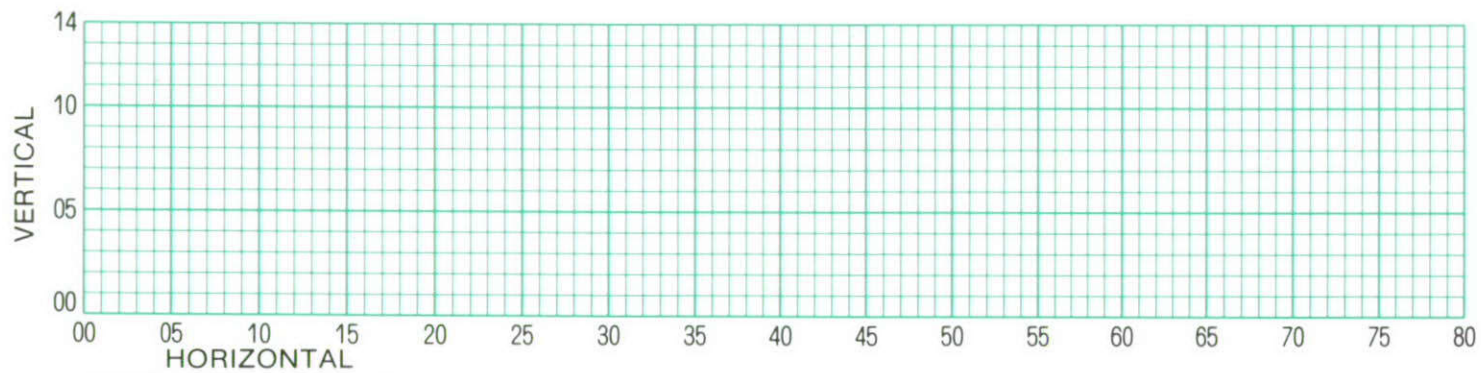

S	1	2	3	4	5	6	7	8	9	10	11	12	13	14	15	16	17	18	19	20	21	22	23	24	25	
H																										
V																										
S	26	27	28	29	30	31	32	33	34	35	36	37	38	39	40	41	42	43	44	45	46	47	48	49	50	
H																										
V																										

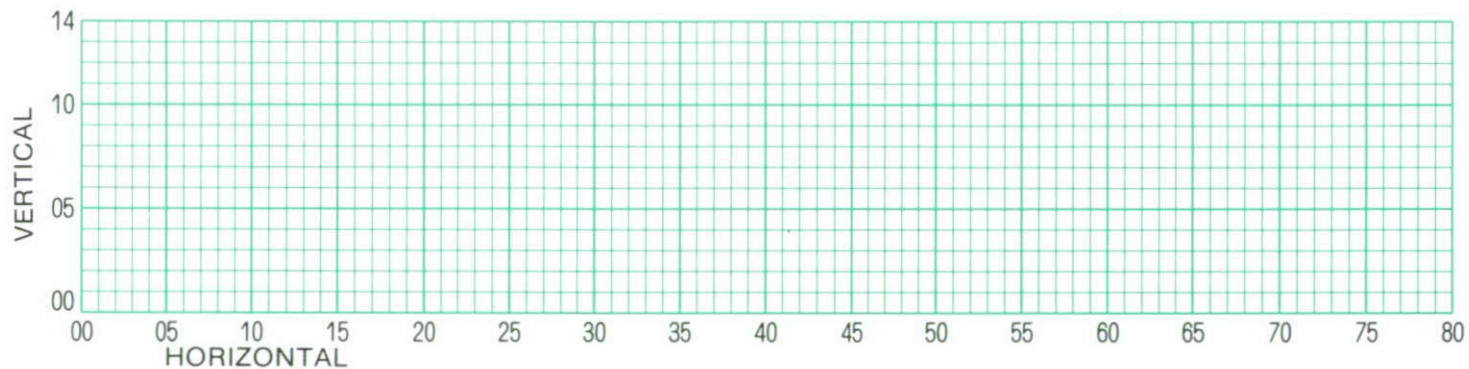

S	1	2	3	4	5	6	7	8	9	10	11	12	13	14	15	16	17	18	19	20	21	22	23	24	25	
H																										
V																										
S	26	27	28	29	30	31	32	33	34	35	36	37	38	39	40	41	42	43	44	45	46	47	48	49	50	
H																										
V																										

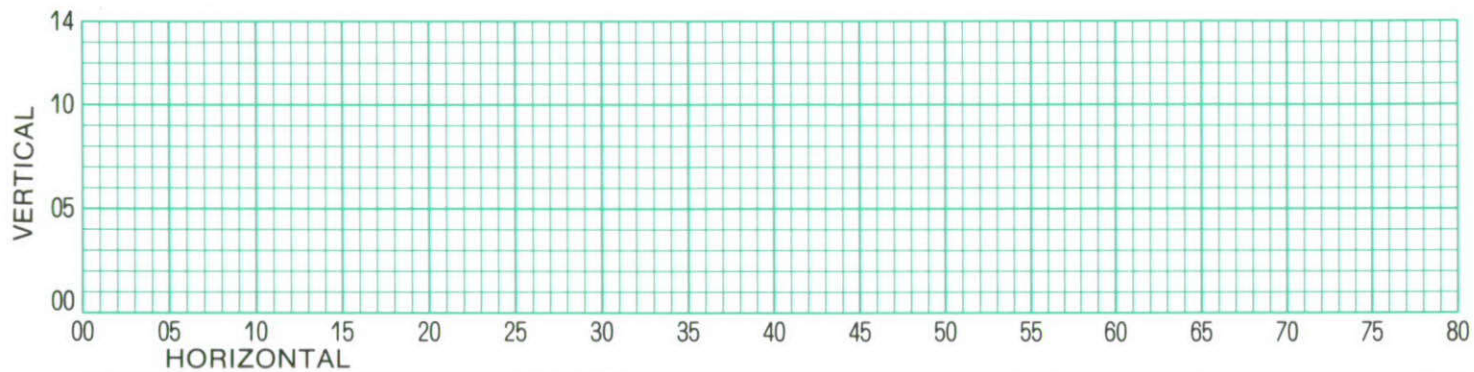

S	1	2	3	4	5	6	7	8	9	10	11	12	13	14	15	16	17	18	19	20	21	22	23	24	25
H																									
V																									
S	26	27	28	29	30	31	32	33	34	35	36	37	38	39	40	41	42	43	44	45	46	47	48	49	50
H																									
V																									

NOTICE

THIS PRODUCT IS MANUFACTURED NOT TO CAUSE UNDUE RADIO OR TELEVISION INTERFERENCE IN ACCORDANCE WITH 82/499/EEC.
SUR CE MATERIEL, IL EST ADAPTE UN MOTEUR ANTI-PARASITE SELON LES NORMES CEE 82/499.
"DIT ARTIKEL VOLDOET AAN DE VOORSCHRIFTEN M. B. T. DE RADIO ONTSTORINGS RICHTLIJNEN VOLGENS EEC 82/499".

IMPORTANT

The wires in this mains lead are coloured in accordance with the following code:

BLUE - NEUTRAL BROWN - LIVE

As the colours of the wires in the mains lead of this appliance may not correspond with the coloured markings identifying the terminals in your plug, proceed as follows:

The wire which is coloured BLUE must be connected to the terminal which is marked with the Letter N or coloured BLACK.

The wire which is coloured BROWN must be connected to the terminal which is marked with the Letter L or coloured RED.

If a 13 amp (B.S. 1363) plug is used a 3 amp fuse must be fitted, or if any other type of plug is used, a 5 amp fuse must be fitted either in the plug or adaptor, or at the distribution board.

NOTE: This product is double insulated and therefore requires no earth connection.

123325001

PRINTED IN JAPAN
191870-011(A)