

Professional Color Television  
**ScanCard II™**



# OWNER'S MANUAL

AND  
SET-UP GUIDE



**Setting** Industry Standards™



*Let's make things better.*



**PHILIPS**

# KNOW THESE SAFETY SYMBOLS



▲ This “bolt of lightning” indicates uninsulated material within your unit which may cause an electrical shock. For the safety of everyone in your household, please do not remove product covering.

▲ The “exclamation point” calls attention to features for which you should read the enclosed literature closely to prevent operating and maintenance problems.

**WARNING: TO PREVENT FIRE OR SHOCK HAZARD, DO NOT EXPOSE THIS EQUIPMENT TO RAIN OR MOISTURE.**

**CAUTION:** To prevent electric shock, match wide blade of plug to wide slot, and fully insert.

**ATTENTION:** Pour éviter les chocs électriques, introduire la lame la plus large de la fiche dans la borne correspondante de la prise et pousser jussssqu'au fond.

**For Customer Use:**

Enter below the Serial No. which is located on the product. Retain this information for future reference.

Model No \_\_\_\_\_

Serial No. \_\_\_\_\_



ScanCard II™, SmartCard™Television, SmartLink™ Connector and SmartPlug™ Series are all registered trademarks of the Philips Consumer Electronics Company.

Microsoft WINDOWS™ and the WINDOWS™ logo are registered trademarks of the Microsoft Corporation in the United States and/or other countries.



MACINTOSH™ is the registered trademark of Apple Computer.

# TABLE OF CONTENTS

## Getting Started

-  Warning/Precautions .....2
-  Introduction .....4
-  Features .....5
- Unpacking and Assembly .....6-7
- Installation .....8-9
- Input/Output Jacks .....9



## Hooking up the ScanCard II Television

-  • Antenna TV Connections .....10-11
-  • Cable TV Connections .....12-13
- Audio/Video Input Connections .....14-15
- S-Video Input Connections .....16-17
- VGA Input Connections (PC, Macintosh) ...18-19
- RS 232 Input Connection .....20

## Basic Operations

-  • Basic Television Control Panel Operations ..21
-  • Basic Remote Control Operations .....22-23



## On-Screen Menu Options

-  • On-Screen Menu and Picture Adjustments ..24
-  • TV Picture Setup Menu .....25
- Description of TV Picture Setup Options .....25
- VGA Picture Setup Menu .....26
- Description of VGA Picture Setup Options ....27
- VGA Image Adjustments .....28
- Description of VGA Image Adjustments .....29
- Commercial Settings Menu .....30
- Description of Commercial Settings .....31
- Television Features .....32
- Description of Television Features .....32-34

- Closed Captioning .....35

- Zoom and Pan Feature .....36

## General Information

-  Index .....37
-  Glossary .....38
-  Warranty .....39

## INTRODUCTION

ScanCard II provides a method of displaying VGA/SVGA, composite video, S-Video, and various audio connections to any of the Philips 19", 25", 27", 32" or 36" SmartCard televisions. This allows the user more dynamic picture and sound quality when using computers, video cameras, VCRs, DVD Players, Laser Disc Players, CD-i Players, Web Browsers, and Satellite Systems.

With use of a T374AH Setup Remote (*see T374AH Remote Control Instructions - part # IB7166E002 for complete details*), the installer can adjust the normal commercial television functions (with the exception of the BRIGHTNESS and PICTURE settings for VGA and NON-VGA display modes). ScanCard II will store a separate set of BRIGHTNESS and PICTURE settings for these display modes. This allows the display to be optimized for computer generated graphics while retaining display settings that are pleasing for off-air or accessory equipment viewing (VCR, DVD, etc.).

With the ability to adjust the picture through horizontal and vertical scaling, ScanCard II allows full use of your display when using the most current computer software applications.

When tuned to the VGA channel, ScanCard II gives the option of viewing the display twice as large with a 2x ZOOM feature. This larger display can be "PANNED" left, right, up, or down by pressing the remote's CURSOR  keys.

This unique television module can easily be linked or "daisy chained" to multiple monitors using the "loop-through" jacks located on the rear jack panel of ScanCard II. You can create a central control area with many monitoring stations, ideal for educational purposes.

Access to additional external inputs provided by ScanCard II can be obtained simply by changing channels. Using the channel UP/DOWN buttons to select the three channels directly below the lowest broadcast channel, will allow the use of AUX, S-VIDEO, and VGA inputs. These "channels" can also be selected directly using the supplied remote. This remote has dedicated buttons labeled SVID, VGA, and AUX. Pressing any of these buttons will directly tune the SmartCard TV to its respective channel (or input jack).

ScanCard II transforms any SmartCard television into the ultimate display for computer graphics, TV broadcast programming, inter-active CD-Rom, DVD, Laser Disc Players or any of today's hi-tech entertainment devices.

## FEATURES

- **Scan Conversion** of VGA input is as follows, but not limited to:

Mode	Resolution	Horiz.	Vert.
VGA TEXT	720 x 400	31.5kHz	70Hz
VGA/MCGA	320 x 200	31.5kHz	70Hz
VGA	640 x 350	31.5kHz	70Hz
VGA	640 x 400	31.5kHz	70Hz
VGA	640 x 480	31.5kHz	60Hz
VGA/VESA	640 x 480	37.8kHz	72Hz
SVGA/VESA	800 x 600	35.2kHz	56Hz
SVGA/VESA	800 x 600	37.9kHz	60Hz
SVGA/VESA	800 x 600	48.1kHz	72Hz
XGA/VESA	1024 x 768	48.3kHz	60Hz
XGA/VESA	1024 x 768	56.4kHz	70Hz
XGA/VESA	1024 x 768	61.1kHz	75.8Hz
*Mac 13"	640 x 480	35	60Hz
*E-Mac	832 x 624	44.9	67Hz
*Mac 16"	832 x 624	49.7	75Hz
*Super Mac	1024 x 768	48	60Hz
*Mac 19"	1024 x 768	60.2	75Hz

- \* ScanCard II requires separate sync signals.  
All Macintosh Computers have not been tested with this product

- **VGA/SVGA Input** with buffered Loop-thru Output.
- **VGA/SVGA Audio Input**
- **S-VIDEO Video/Audio Inputs** with Loop-thru Outputs.
- **AUX Video/Audio Inputs** with Loop-thru Outputs.
- **Clone Port** for limited applications.
- **RS 232 Connector** allows interface of a computer and the TV, giving control of the TV functions to the computer.
- **Independent TV picture controls** (bright, picture) for each mode of display (TV or VGA).
- **Switchable Anti-Flicker vertical filter** (ON or OFF).
- **Adjustable horizontal and vertical positioning** of the VGA display.
- **Adjustable horizontal and vertical scaling** of picture size. Including a Pan and Zoom option on the remote.
- **VGA/SVGA 2x Zoom Mode** with Pan Capability.
- **Audio/Video jack panel** for direct connections with VCRs (or other video accessories) for quality TV picture and sound playback.
- **MAC Adapter** 50-75Hz flexible refresh rate.

## SCANCARD II ASSEMBLY

When unpacking the ScanCard II components from the box, be careful pulling the items out. The box is packed with five separately packaged items; The ScanCard II Assembly Cover, the ScanCard II Circuit Board, the ScanCard II Jack Panel Board, the RF Input Plug/Retaining Nut/Hex Head Screw, and the Remote Control Unit. Unfold the Cardboard holders to release the two Circuit Boards and use the following instructions to assemble the unit.

### BEGIN

- 1 Line up the 25 pin connector on the ScanCard II Circuit board with the 25 pin connector on the Jack Panel board. Carefully but firmly, press the connectors together until the pins are fully set into the designated connector.
- 2 Attach the RF Input Plug to the ScanCard II Assembly Cover, and use the Retaining Nut to secure it to the cover.
- 3 Using the Hex Head Screw supplied, secure the Jack Panel board to the ScanCard II Cover.

### SMART HELP

Remember to be careful when pushing the 25 Pin connectors together. Try not to bend or force the pins into place. If they will not slide in easily, please disconnect the two boards and start over.

Do not over tighten the Hex Head Screw when securing the Assembly to its cover. Over tightening can cause stripping of the ScanCard II Assembly Cover.

6

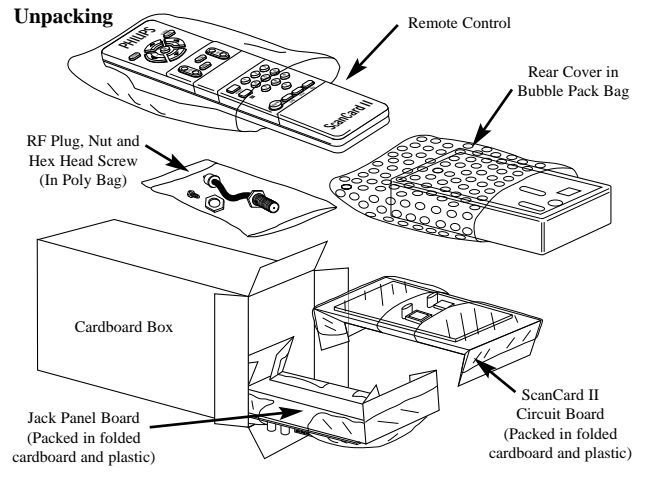

### Assembly

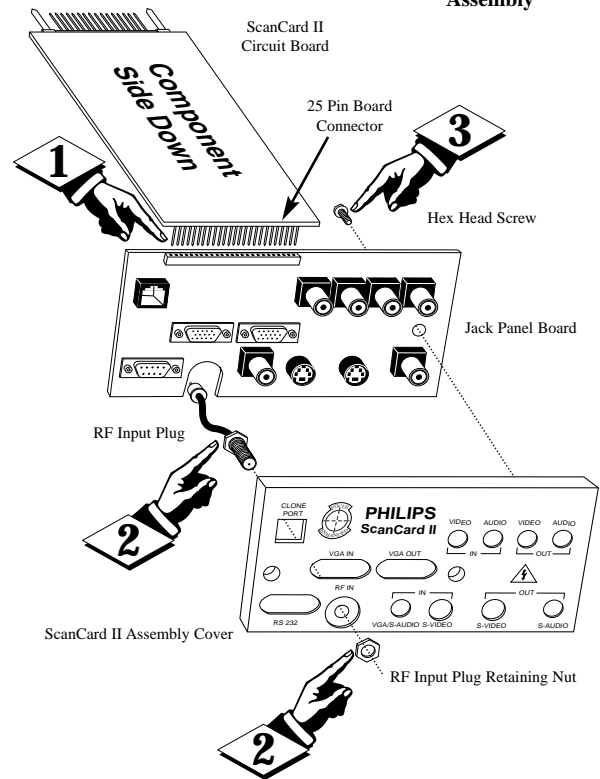

7

# INSTALLING SCANCARD II

*Installation of the ScanCard II is easy. Remember to follow these instructions, be patient, and use the T374AH Set Up Remote Control (see T374AH Remote Control Instructions - part # IB7166E002 for complete details). Note: This is not the remote supplied with the ScanCard II package.*

**BEGIN**

- 1** Start by unplugging the AC power cord from the wall socket. Remove the hex head screws holding the card cover in place. Slide the card cover off. Be careful when pulling the Antenna jack (RF IN) out of its plug.
- 2** Insert the ScanCard II (with its components facing down) into the back of the TV. Line up and guide the 32 pin connector into place. Note: There are guide pins to help line up the Card properly. Gently, but firmly, press the card into place by pushing on the card cover directly in line with the circuit board itself. **DO NOT** press the card into place by pushing on the corners of the card cover.
- 3** Press the RF IN (Antenna) jack firmly into its plug and replace the hex head screws to secure the card and card cover to the rear of the TV.

**SMART HELP**

Remember, unplug the TV to avoid electrical shock damage to the TV.

Be sure to align the 32 pin connector before pressing into place. Never force the ScanCard II into the connector. If it will not go in smoothly, realign the guide pins and try again.

**Do not use the ScanCard II jacks to push the card assembly into place. Push on the cover directly behind the card itself.**

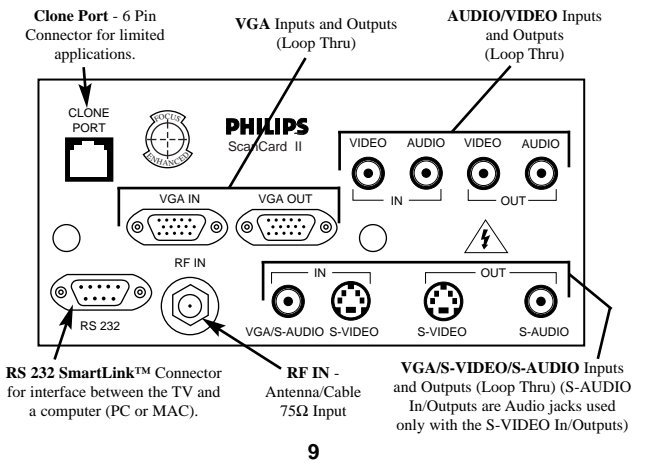
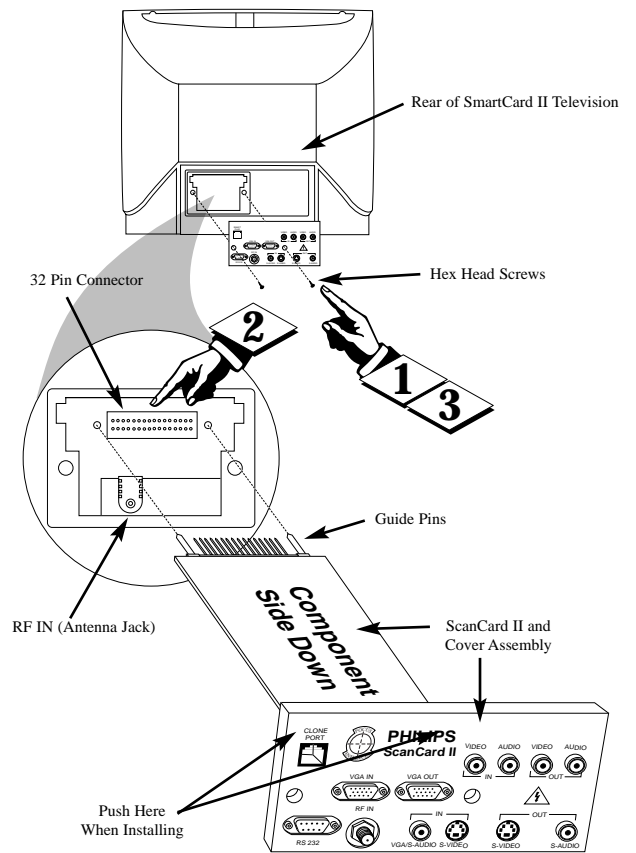

## ANTENNA HOOKUPS

A combination antenna receives normal broadcast channels (VHF 2-13 and UHF 14-69). Your connection is easy since there is only one 75Ω (ohm) antenna plug on the back of your TV - and that's where the antenna goes. (If you have more than one antenna, please refer to the diagram at the bottom of page 11 for additional hookups.)

### BEGIN

- 1 If your antenna has a round cable (75 ohm) on the end, then you're ready to connect it to the TV.
  - If your antenna has flat twin-lead wire (300 ohm), you first need to attach the antenna wires to the screws on a 300 to 75 ohm adapter.
- 2 Push the round end of the adapter (or antenna) onto the RF IN plug on the rear of the TV. If the round end of the antenna wire is threaded, screw it down tight.

**SMART HELP**

Remember, be sure to set the TV for the type signal you've connected.

To set the TV to select only the channel numbers in your area see how to "Program" or "Add" channels in memory.

To order any optional accessory contact your dealer or call the toll-free accessory ordering number (1-800-292-6066):

- UHF/VHF Combiner: (SBV1133AO1)
- 75-300 Ohm Adapter: (SBV1113AO1)
- 300-75 Ohm Adapter: (483521827003)

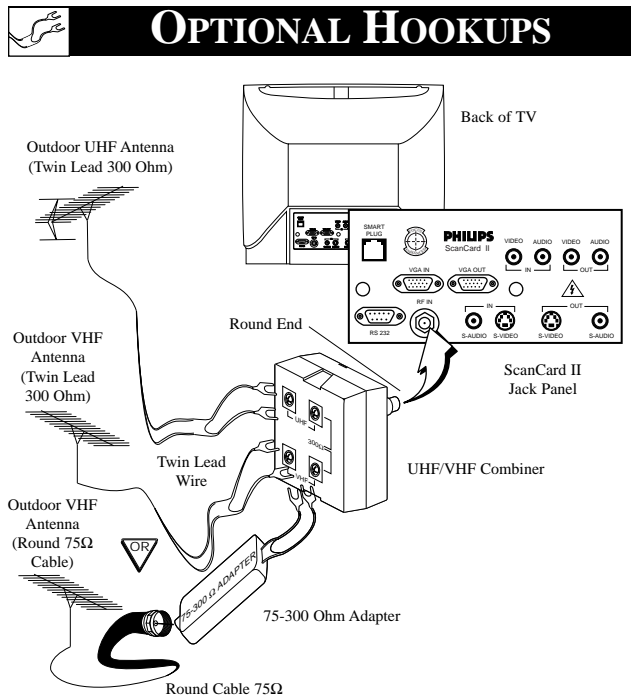
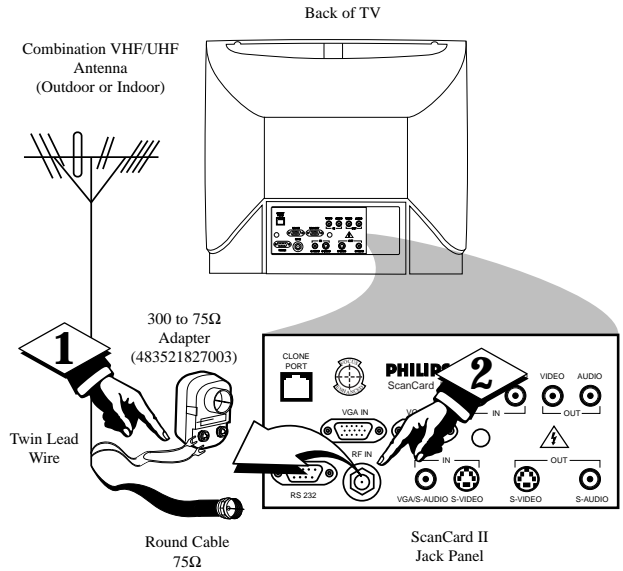

## CABLE TV HOOKUP

Your Cable TV input into your home may be a single (75 ohm) cable, or a Converter Box installation. In either case the connection to the TV is very easy. Just put the threaded end of the cable signal to the TV's antenna plug and screw it down tight.

**BEGIN**

- 1 If your Cable TV signal is a single round cable (75 ohm) then you're ready to connect to the TV.  
**If you have a Cable TV Converter Box:**  
 Connect the Cable TV signal to the Cable Signal IN(put) plug on the Converter.
- 2 Connect the Cable TV cable to the RF IN plug on the TV.  
**If you have a Cable TV Converter Box:**  
 Connect the OUT(put) plug from the Converter to the RF IN plug on the TV (connecting cable supplied with the Converter.)

**SMART HELP**

Remember, set the TV to the "Cable TV Mode." Then, to select only the channel numbers on your Cable system see "Auto Program" (refer to page 33 for both features).

If you use a Cable Converter box, set the TV to the same channel as the converter's CH 3/4 switch (on the rear of the converter.)

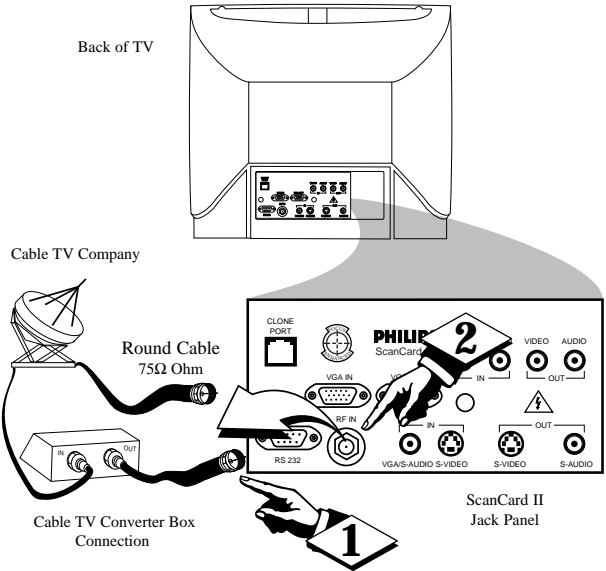

## OPTIONAL VCR HOOKUP

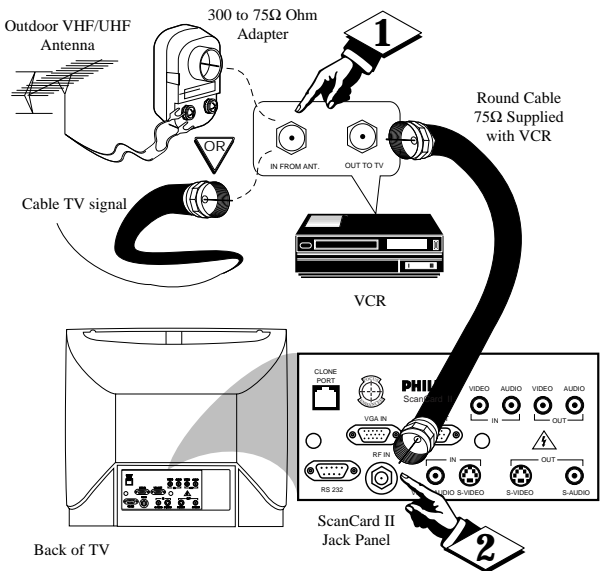

## AUDIO/VIDEO INPUTS

You can view the playback of VCR tapes (Video Disc Players, Camcorders, etc.) by using the AUDIO and VIDEO INPUT jacks (on the ScanCard II Cover assembly).

For example: Use the following steps to view the playback of a pre-recorded VCR tape

### BEGIN

- 1 Connect the VIDEO and AUDIO IN(put) jacks on the TV to the AUDIO and VIDEO OUT(put) jacks on the VCR.
- 2 Press the CHANNEL ▼ button three channels below the lowest broadcast channel to activate the AUX inputs.
- 3 Turn the VCR ON. Insert a pre-recorded tape into the VCR. Press PLAY on the VCR to view the tape on the TV.

### SMART HELP

Remember, when your through using the A/V INPUT (OUTPUT) jacks, change the channel number back to the desired viewing channel (or the screen will remain blank).

NOTE: If you have a stereo VCR, "Y" Connectors are available (from your dealer or Parts Information Center 1-800-292-6066) to connect to the audio input on the TV.

Front Control Panel of TV

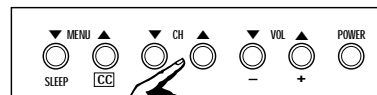

Back of TV

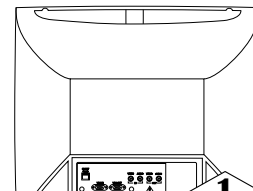

Rear Jacks of the ScanCard II Assembly

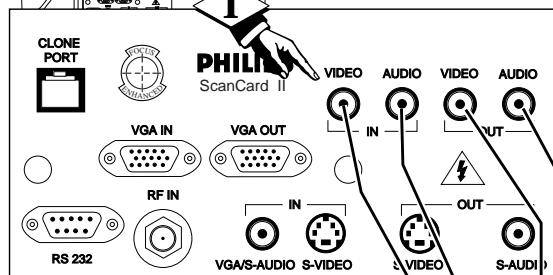

Video RCA Phono Plug Cable (not supplied)

Audio RCA Phono Plug Cable (not supplied)



Optional VCR

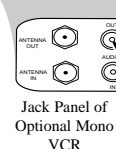

Jack Panel of Optional Mono VCR

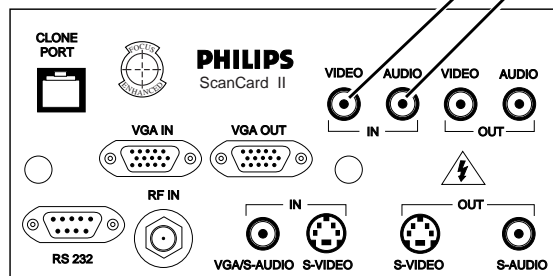

Optional Hook Up of Second TV Using Loop-Thru Outputs



## S-VIDEO INPUTS

The *S(uper)-Video* connection on the rear of the TV can give you better picture detail and clarity, for the playback of S-VHS VCR tapes, rather than the normal antenna picture connections.

Note: The VCR (or accessory device) must have a S-VIDEO OUT(put) jack in order for you to complete the steps and connections shown to the right.

### (BEGIN)

- 1 **Connect the S-VIDEO (S-VHS) OUT(put) jack** from the VCR (or other source) to the V-VIDEO IN(put) jack on the TV. Normally the S-VIDEO connecting cable will be supplied with accessory devices supplied with a S-VIDEO jack.
- 2 **Press the CHANNEL ▼ button** two channels below the lowest broadcast channel to activate the S-VIDEO inputs/outputs.
- 3 **Turn the VCR ON.** Insert a pre-recorded S-VHS tape into the VCR. Press PLAY on the VCR to view the tape on the TV.



### SMART HELP

Remember, after it is connected an easy way to select the S-VIDEO mode is to scan two channels below the lowest broadcast channel.

NOTE: If you have a stereo VCR, "Y" Connectors are available (from your dealer or Parts Information Center 1-800-292-6066) to connect to the audio input on the TV.

Front Control Panel of TV

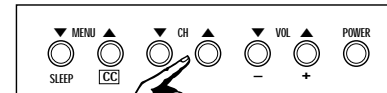

Back of TV

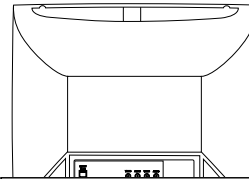

Rear Jacks of the ScanCard II Assembly

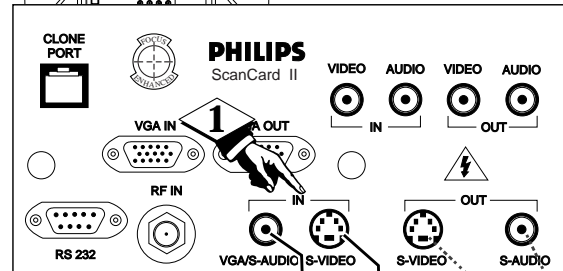

Audio RCA Phono Plug Cable (not supplied)  
S-VIDEO Cable (supplied with optional S-VHS VCR)

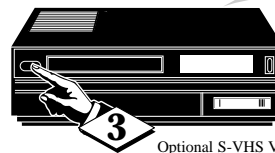

Optional S-VHS VCR

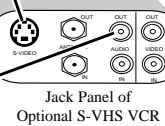

Jack Panel of Optional S-VHS VCR

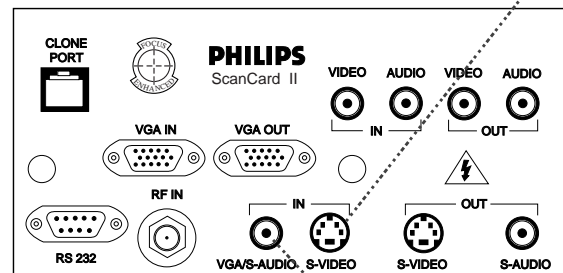

Optional VGA/S-AUDIO; S-VIDEO Hook Up of Second TV Using Loop-Thru Outputs



## VGA INPUTS

*The main purpose of the ScanCard II is its ability to convert VGA/SVGA inputted data from a computer to S-Video data, thus showing computer generated graphics on the screen of a Philips SmartCard TV.*

*The following are suggested computer connections to the ScanCard II.*

### BEGIN

- 1 **It is always a good idea to remove the TV's, and the computer's, AC power cords** from the wall socket before beginning the connections. The VGA Input accepts signals from VGA and MAC compatible computers without the need for any additional hardware.
- 2 **For PC Applications:** Plug the VGA cable into the VGA Input terminal on the back of a commercial TV equipped with the Philips ScanCard II. Then attach the other end of the VGA cable to the VGA (RGB) Output on the back of the computer. (Secure the plugs by tightening the thumb screws.) Reattach the AC Power cords to the wall sockets before powering on the units.

**For Macintosh Applications:** Connect the MAC/VGA adapter to the RGB Output of a Macintosh Series computer. Then firmly plug the VGA cable into both the VGA Input on the TV and the MAC/VGA adapter on the computer. (Secure the plugs by tightening the thumb screws.) Reattach the AC Power cords to the wall sockets before powering on the units.

**Please note:** If using an educational 5200 series Macintosh, the addition of a POWER R adapter must be installed when making this connection.

**Using the Channel ▼ button** select one channel below your lowest available broadcast channel to access the VGA Inputs.

**NOTE: The ScanCard™ VGA connections allow for the use of WINDOWS 95™, WINDOWS™, WINDOWS™ based programs, DOS, and MACINTOSH™ based programs only.**



## PC CONNECTIONS

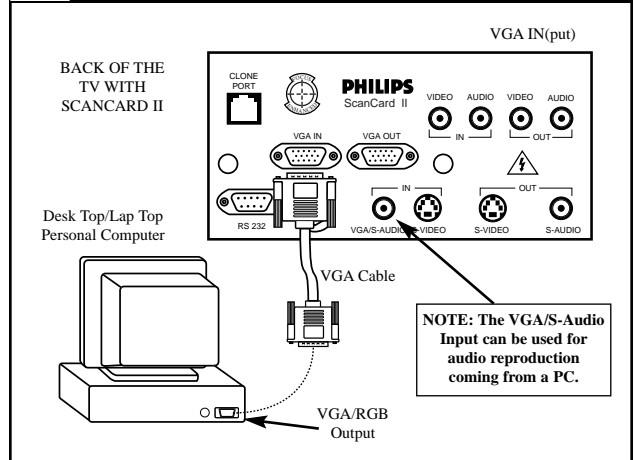

## MACINTOSH CONNECTIONS

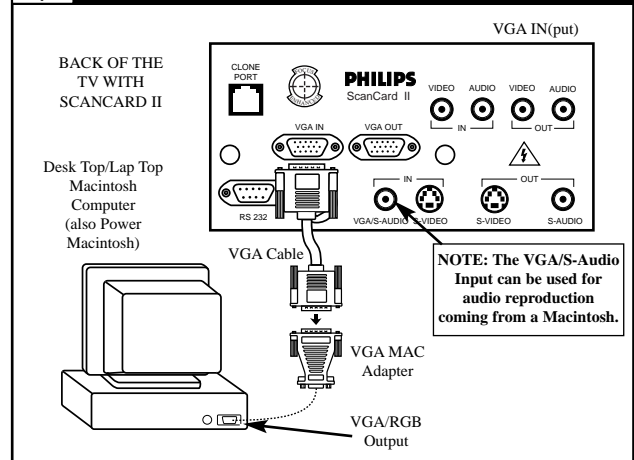

## RS 232 INPUT

*The ScanCard II assembly is equipped with a RS 232 (Serial) Input. When a computer's Serial Port is hooked to the ScanCard II through the RS 232 input, the computer can control the various functions of the television. (Refer to SmarKLink specifications available under DNA.)*

**BEGIN**

- 1 It is always a good idea to remove the TV's, and the computer's, AC power cords from the wall socket before beginning the connections. The RS 232 (Serial) Input accepts signals from VGA and MAC compatible computers that have external Serial Ports.
- 2 For PC/MACs with Serial Ports: Plug a Serial cable into the RS 232 (Serial) Input terminal on the back of a commercial TV equipped with the ScanCard II. Then attach the other end of the Serial cable to the Serial Output Port on the back of the computer. (Secure the plugs by tightening the thumb screws.)
- 3 Reattach the AC Power cords to the wall sockets before powering on the units.

## RS 232 CONNECTIONS

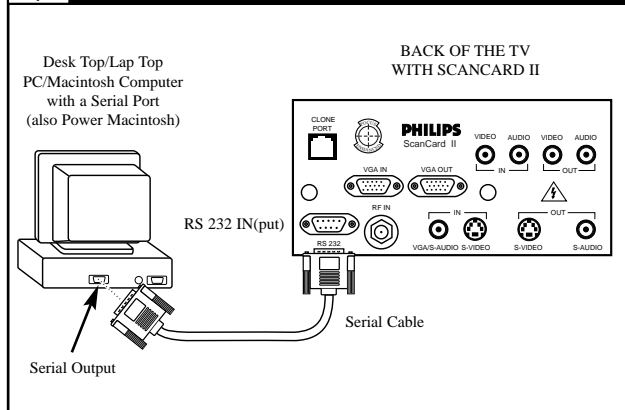

## TELEVISION OPERATION

**BEGIN**

- 1 Press the **POWER** button to turn the TV ON.
- 2 Press the **VOLUME UP (▲)** or **DOWN (▼)** button to adjust the sound level.
- 3 Press the **CHANNEL UP (▲)** or **DOWN (▼)** button to select TV channels.

**The TELEVISION CONTROL PANEL**

- MENU ▼ Button** - Brings the on-screen menu up and allows the user to scroll thru the options.
- SLEEP Button** - With the ScanCard II assembly installed, the Sleep option at the television control panel is rendered inoperable.
- MENU ▲ Button** - Will clear the screen when the on-screen menu is visible.
- CC Button** - Will bring up the Closed Captioning options. Repeated pressing of this button will allow the user to change those options. (Will not operate when tuned to the VGA channel.)
- CHANNEL ▼▲ Buttons** - Use these buttons to scroll thru available channels. These buttons will also allow you to scroll thru the on-screen menu options when displayed.
- VOLUME ▼▲ (- or +) Buttons** - Use these buttons to increase or decrease the audio level output of the TV. The (-) or (+) function for these buttons is to select certain options from within the on-screen menu.
- POWER Button** - Toggle between turning the TV ON and OFF.

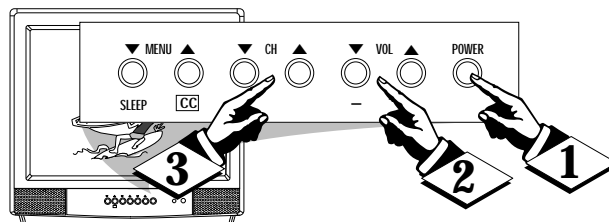

**Note: The KEYBOARD Buttons can be controlled using the "FRONT KEYPAD" feature within the "Commercial Settings" menu (refer to page 30 for more details).**

## REMOTE OPERATION

The ScanCard II Remote Control is used to operate the functions of this ScanCard II television as well as some other PCEC Commercial chassis units.

The three buttons located at the bottom of the remote (labeled **SVID**, **VGA**, and **AUX**) are called "Direct Channel Select" buttons and are used to select the desired input source directly from the jack panel.

To access the on-screen menu system follow the steps below:

**Press the POWER button** to turn the TV on.

**Press the SELECT (M) button** to display the on-screen menu options. These Menus will vary depending on the tuned channel. (Refer to the On-Screen Menu section, pages 24-34.)

**Press the CURSOR** buttons to navigate through the on-screen menus and make menu changes.

**NOTE:** If performing a setup with a TH374AH Setup Remote, see Remote Control Instructions - part #IB7166E002 for details. All the functions will operate normally with the exception of the BRIGHTNESS and PICTURE controls. The ScanCard II will store a separate set of BRIGHTNESS and PICTURE settings for VGA and non-VGA display modes. This allows the display to be optimized for computer generated graphics or settings that are pleasing for off-air/accessory viewing (used with VCR, Video Disc Player, CD-i Player, etc.).

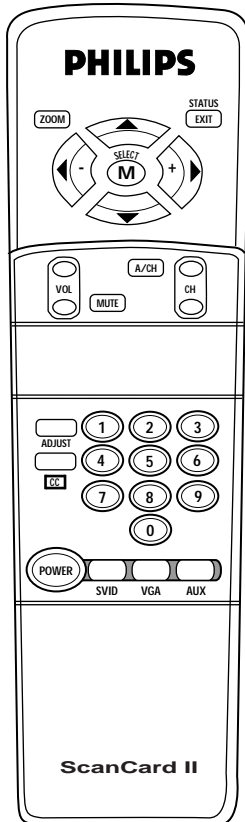

22

## REMOTE OPERATION

Listed below is a brief description of each button's function. Some buttons may perform more than one function depending on the mode or function selected.

**ZOOM** - Press this button to enlarge the image on screen 2 times its normal viewing size. (Use the CURSOR buttons to pan up, down, and left, right.) **Note: This feature ONLY works when tuned to the VGA channel.**

**SELECT (M)** - Press this button to bring up the on-screen menu options. Also may be used to select items within the menu.

**VOL(ume)** - Press this button to adjust the sound level of the TV.

**MUTE** - Press this button to turn the sound OFF on the TV. Press again to return the sound to its previous level.

**ADJUST** - Press this button to adjust the TV's picture or the VGA image.

**CC** - Press this button to bring the Closed Captioning option to the screen. **Note: This feature WILL NOT work when tuned to the VGA channel.**

**POWER** - Press this button to turn the TV ON or OFF.

**SVID** - Press this button to tune the TV to the ScanCard II's S-VIDEO Input jack.

**VGA** - Press this button to tune the TV to the ScanCard II's VGA Input jack.

**STATUS/EXIT** - Press this button to clear the screen of the menu and save function changes made within the on-screen menus.

**CURSOR KEYS** - Press these buttons (▲▼▶◀) to scroll or move through the on-screen menu or to adjust the picture in certain features.

**CH(annel)** - Press this button to scroll through all available channels.

**A/CH** - Press this button to toggle between the present and last viewed channels.

**NUMBERED BUTTONS** - Press these buttons to directly access any available channel. (If a single digit channel is chosen, press 0 first. Example for channel 6; first press 0, then 6.)

**AUX** - Press this button to tune the TV to the ScanCard II's AUXILIARY Input jack.

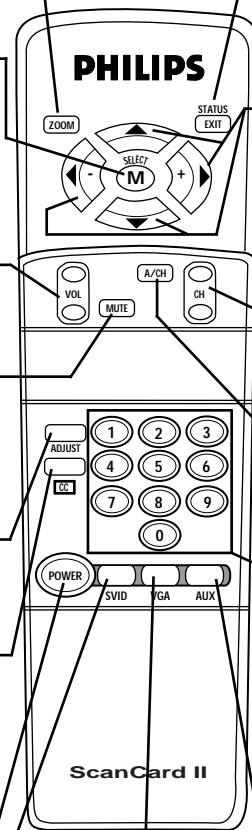

23

## ON-SCREEN MENU CONTROLS

**S**canCard II has two different operation modes; *Consumer* and *Commercial*. When in the *Consumer* mode, all available menu items and tuning options are fully enabled (with the exception of the *COMMERCIAL SETTING* menu). Access to ScanCard II's internal "TV PICTURE SETUP," "VGA PICTURE SETUP," and the TV's "SETUP" menus can be selected with the supplied ScanCard II remote control. When in the *Commercial* mode, limited menu access can be obtained. Only the "TV PICTURE SETUP," and "VGA PICTURE SETUP" menus are accessible with the supplied ScanCard II remote control.

## PICTURE ADJUSTMENTS

**Y**ou can make some adjustments to the TV picture using the TV PICTURE SETUP or the VGA PICTURE SETUP on-screen menu. Follow the steps below for the proper procedure.

### BEGIN

- 1 Press the **SELECT (M)** button on the remote control to see the on-screen menu.
- 2 Press the **MENU ▼▲** on the remote control repeatedly to move the highlight to the desired feature to change or adjust.
- 3 Press the **MENU ◀▶** buttons on the remote control to adjust or change the highlighted feature.
- 4 Press the **STATUS/EXIT** button on the remote control to clear the screen when finished.

## TV PICTURE SETUP MENU

**W**hen viewing normal broadcast channels only the **BRIGHTNESS** and **PICTURE** controls can be changed, or the TV can be restored to its **PRESETS (RESTORE PRESETS)**. This menu can be accessed by the **MENU** or **ADJUST** buttons on the remote.

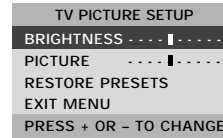

Adjust **BRIGHTNESS** using the + or - buttons.

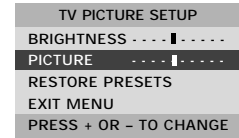

Adjust **PICTURE** using the + or - buttons.



**RESTORE PRESETS** using the + button.

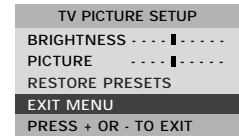

**EXIT** the menu using the + or - buttons.

## TV PICTURE SETUP DESCRIPTIONS

**Brightness Control** - Press the (+) or (-) button to adjust the brightness to the desired level. The (+) button increases the picture **BRIGHTNESS** while the (-) button will decrease the picture **BRIGHTNESS**.

**Picture Control** - Press the (+) or (-) button to adjust the picture quality. This controls the pictures clarity and contrast.

**Restore Presets** - Pressing the (+) button will restore the menu options back to the preset options set by the setup technician.

**Exit Menu** - Press the (+) or (-) button to clear the on-screen menu from the picture.

## VGA PICTURE SETUP MENU

When using the VGA INPUTS the BRIGHTNESS, PICTURE, AUDIO, TYPE of INPUT (PC or MAC) and IMAGE adjustments (ADJUST VGA IMAGE) can be changed or adjusted. The TV picture can also be restored to its original PRESETS (RESTORE PRESETS).

VGA PICTURE SETUP	
BRIGHTNESS	----- -----
PICTURE	----- -----
VGA AUDIO	ON
INPUT TYPE	PC
ADJUST VGA IMAGE	
RESTORE PRESETS	
EXIT MENU	
PRESS + / - TO ADJUST	

Adjust BRIGHTNESS using the + or - buttons.

VGA PICTURE SETUP	
BRIGHTNESS	----- -----
PICTURE	----- -----
VGA AUDIO	ON
INPUT TYPE	PC
ADJUST VGA IMAGE	
RESTORE PRESETS	
EXIT MENU	
PRESS + / - TO ADJUST	

Adjust PICTURE using the + or - buttons.

VGA PICTURE SETUP	
BRIGHTNESS	----- -----
PICTURE	----- -----
VGA AUDIO	ON
INPUT TYPE	PC
ADJUST VGA IMAGE	
RESTORE PRESETS	
EXIT MENU	
- FOR OFF / + FOR ON	

Press the - button to mute the audio, or the + button to turn the audio ON (VGA mode only)

VGA PICTURE SETUP	
BRIGHTNESS	----- -----
PICTURE	----- -----
VGA AUDIO	ON
INPUT TYPE	PC
ADJUST VGA IMAGE	
RESTORE PRESETS	
EXIT MENU	
- FOR MAC / + FOR PC	

Press the - button if using a Macintosh, or the + button if using a PC.

### ADJUST VGA IMAGE

VGA PICTURE SETUP	
BRIGHTNESS	----- -----
PICTURE	----- -----
VGA AUDIO	ON
INPUT TYPE	PC
ADJUST VGA IMAGE	
RESTORE PRESETS	
EXIT MENU	
PRESS + TO ADJUST IMAGE	

Press the + button to access the VGA IMAGE ADJUSTMENT menu.

When you access the ADJUST VGA IMAGE menu, the following items can be changed or adjusted: HORIZONTAL SIZE and POSITION, VERTICAL SIZE and POSITION, VGA GAIN LEVEL, COLOR INTENSITY, and a FLICKER FILTER. For more details, refer to VGA IMAGE ADJUSTMENT menu on page 28.

VGA PICTURE SETUP	
BRIGHTNESS	----- -----
PICTURE	----- -----
VGA AUDIO	ON
INPUT TYPE	PC
ADJUST VGA IMAGE	
RESTORE PRESETS	
EXIT MENU	
PRESS + TO RESTORE	

Restore PRESETS using the + button.

VGA PICTURE SETUP	
BRIGHTNESS	----- -----
PICTURE	----- -----
VGA AUDIO	ON
INPUT TYPE	PC
ADJUST VGA IMAGE	
RESTORE PRESETS	
EXIT MENU	
PRESS + TO EXIT	

EXIT the on-screen menu using the + button.

## VGA PICTURE SETUP DESCRIPTIONS

**Adjust VGA Image** - Press the (+) or (-) button to activate the "VGA IMAGE ADJUSTMENT" menu. (Refer to page 28 for more details.)

**Brightness Control** - Press the (+) or (-) button to adjust the brightness to the desired level. The (+) button increases the picture BRIGHTNESS while the (-) button will decrease the picture BRIGHTNESS.

**Input Type** - Press the (+) or (-) button to select between the PC mode or the Macintosh mode. ScanCard II optimizes screen geometries and configuration information for the selected compatible platform.

**Picture Control** - Press the (+) or (-) button to adjust the picture quality. This controls the pictures clarity and contrast..

**VGA Audio** - Press the (+) or (-) button to activate or mute the audio signal whenever the VGA channel is tuned. With VGA AUDIO "OFF" selected, all volume and mute commands will be ignored.

**Restore Presets** - Pressing the (+) button will restore the menu options back to the preset options set by the setup technician.

**Exit Menu** - Press the (+) or (-) button to clear the on-screen menu from the picture.

## VGA IMAGE ADJUSTMENT MENU

The **VGA IMAGE ADJUSTMENT** menu will allow you to move the positioning of the display both vertically and horizontally and change its size in both directions. The **VGA GAIN LEVEL** can be set **LOW** or **HIGH** along with the picture's **COLOR INTENSITY**. If flickering in the display becomes a problem, ScanCard II has a built-in **FLICKER FILTER** that can be manually turned **ON** or **OFF**.

VGA IMAGE ADJUSTMENT	
HORIZONTAL SIZE	
VERTICAL SIZE	
HORIZONTAL POSITION	
VERTICAL POSITION	
VGA GAIN LEVEL	HIGH
COLOR INTENSITY	HIGH
FLICKER FILTER	ON
EXIT MENU	
- NARROWER / + WIDER	

Press the - button to NARROW the display, or the + button to WIDEN the display.

VGA IMAGE ADJUSTMENT	
HORIZONTAL SIZE	
VERTICAL SIZE	
HORIZONTAL POSITION	
VERTICAL POSITION	
VGA GAIN LEVEL	HIGH
COLOR INTENSITY	HIGH
FLICKER FILTER	ON
EXIT MENU	
- LEFT / + RIGHT	

Press the - button to move the display LEFT, or the + button to move the display RIGHT.

VGA IMAGE ADJUSTMENT	
HORIZONTAL SIZE	
VERTICAL SIZE	
HORIZONTAL POSITION	
VERTICAL POSITION	
VGA GAIN LEVEL	HIGH
COLOR INTENSITY	HIGH
FLICKER FILTER	ON
EXIT MENU	
- FOR LOW / + FOR HIGH	

Press the - button to set the VGA GAIN to LOW, or the + button to set the gain to HIGH.

VGA IMAGE ADJUSTMENT	
HORIZONTAL SIZE	
VERTICAL SIZE	
HORIZONTAL POSITION	
VERTICAL POSITION	
VGA GAIN LEVEL	HIGH
COLOR INTENSITY	HIGH
FLICKER FILTER	ON
EXIT MENU	
- FOR OFF / + FOR ON	

To activate the FLICKER FILTER, press the + button. To turn it OFF press the - button.

VGA IMAGE ADJUSTMENT	
HORIZONTAL SIZE	
VERTICAL SIZE	
HORIZONTAL POSITION	
VERTICAL POSITION	
VGA GAIN LEVEL	HIGH
COLOR INTENSITY	HIGH
FLICKER FILTER	ON
EXIT MENU	
- SHORTER / + TALLER	

Press the - button to SHORTEN the display, or the + button to make the display TALLER.

VGA IMAGE ADJUSTMENT	
HORIZONTAL SIZE	
VERTICAL SIZE	
HORIZONTAL POSITION	
VERTICAL POSITION	
VGA GAIN LEVEL	HIGH
COLOR INTENSITY	HIGH
FLICKER FILTER	ON
EXIT MENU	
- UP / + DOWN	

Press the - button to move the display UP, or the + button to move the display DOWN.

VGA IMAGE ADJUSTMENT	
HORIZONTAL SIZE	
VERTICAL SIZE	
HORIZONTAL POSITION	
VERTICAL POSITION	
VGA GAIN LEVEL	HIGH
COLOR INTENSITY	HIGH
FLICKER FILTER	ON
EXIT MENU	
- FOR LOW / + FOR HIGH	

Press the - button to set the COLOR INTENSITY to LOW, or the + button to set it to HIGH.

VGA IMAGE ADJUSTMENT	
HORIZONTAL SIZE	
VERTICAL SIZE	
HORIZONTAL POSITION	
VERTICAL POSITION	
VGA GAIN LEVEL	HIGH
COLOR INTENSITY	HIGH
FLICKER FILTER	ON
EXIT MENU	
PRESS + TO EXIT	

Press the + button to EXIT the on-screen menu.

## VGA IMAGE ADJUSTMENT DESCRIPTIONS

**Horizontal Size** - Press the (+) or (-) button to adjust the HORIZONTAL size of the scanned picture on the screen. The (+) button will increase the size horizontally, while the (-) button will decrease the size horizontally.

**Vertical Size** - Press the (+) or (-) button to adjust the VERTICAL size of the scanned picture on the screen. The (+) button will increase the size vertically, while the (-) button will decrease the size vertically.

**Horizontal Position** - Press the (+) or (-) button to adjust the HORIZONTAL position of the scanned picture on the screen. Picture will move left to right (+), or right to left (-).

**Vertical Position** - Press the (+) or (-) button to adjust the VERTICAL position of the scanned picture on the screen. Picture will move down (+), or up (-).

**VGA Gain Level** - Press the (+) or (-) button to set the VGA Gain Level LOW or HIGH. Because of signal differences from one VGA source to another, ScanCard II can boost the video signal for a better display.

**Color Intensity** - Press the (+) or (-) button to set the Color Intensity to LOW or HIGH. Setting this feature to LOW can help minimize burn-in and blooming problems common on most television sets.

**Flicker Filter** - Press the (+) or (-) button to activate or deactivate the filter. When "ON" this feature will greatly improve image stability, but it also reduces image sharpness and resolution.

**Exit Menu** - Press the (+) or (-) button to clear the on-screen menu from the picture.

## COMMERCIAL SETTINGS MENU

Pressing the "C" button on the T374AH Setup remote control will show the "COMMERCIAL SETTINGS" menu. This is an area that will only be accessible to the installer when using the Setup Remote. These options can't be accessed with the supplied ScanCard II remote control.

COMMERCIAL SETTINGS	
MODE	COMMERCIAL
FRONT KEYPAD	ON
CABLE MODE	ON
ON CHANNEL	VGA
ON VOLUME	STANDARD
EXIT MENU	
PRESS + OR - TO CHANGE	

Press the + or - button to change the operation mode to COMMERCIAL or CONSUMER.

COMMERCIAL SETTINGS	
MODE	COMMERCIAL
FRONT KEYPAD	ON
CABLE MODE	ON
ON CHANNEL	VGA
ON VOLUME	STANDARD
EXIT MENU	
- FOR OFF / + FOR ON	

Press the - button to turn the FRONT KEYPAD "OFF" or the + button to turn it "ON."

COMMERCIAL SETTINGS	
MODE	COMMERCIAL
FRONT KEYPAD	ON
CABLE MODE	ON
ON CHANNEL	VGA
ON VOLUME	STANDARD
EXIT MENU	
- FOR OFF / + FOR ON	

Press the - button to turn the CABLE MODE "OFF", or the + button to turn it "ON." This allows the user to choose between cable and broadcast modes within the ScanCard II television.

COMMERCIAL SETTINGS	
MODE	COMMERCIAL
FRONT KEYPAD	ON
CABLE MODE	ON
ON CHANNEL	VGA
ON VOLUME	STANDARD
EXIT MENU	
PRESS + OR - TO CHANGE	

Press the + or - button to choose an initial Power On channel for the TV.

COMMERCIAL SETTINGS	
MODE	COMMERCIAL
FRONT KEYPAD	ON
CABLE MODE	ON
ON CHANNEL	VGA
ON VOLUME	STANDARD
EXIT MENU	
PRESS + OR - TO ADJUST	

Press the + or - button to adjust an initial Power On volume level for the TV.

COMMERCIAL SETTINGS	
MODE	COMMERCIAL
FRONT KEYPAD	ON
CABLE MODE	ON
ON CHANNEL	VGA
ON VOLUME	STANDARD
EXIT MENU	
PRESS + TO EXIT	

Press the + button to EXIT this menu.

## COMMERCIAL SETTINGS DESCRIPTIONS

**Mode** - Press the (+) or (-) button to change the TV's operation mode. There are two different operating modes available, "CONSUMER" or "COMMERCIAL." When the ScanCard II is in the "CONSUMER" mode, all menu items and tuning options are fully operational. In this mode the user will be able to access the ScanCard II's internal "TV PICTURE SETUP," "VGA PICTURE SETUP," and the TV's "SETUP" menus with the ScanCard II remote control. When ScanCard II is in the "COMMERCIAL" mode, only the "TV PICTURE SETUP" and "VGA PICTURE SETUP" menus will be accessible with the ScanCard II remote control.

**Front Keypad** - Press the (-) button to turn the TV's Front Controls "OFF", or press the (+) button to turn them "ON." When "FRONT KEYPAD" is "OFF" the TV can only be operated with the Setup or ScanCard II remote control.

**Cable Mode** - Press the (-) button to turn the ScanCard II's Cable Mode "OFF", or press the (+) button to turn it "ON." This feature allows the user to select either cable or broadcast mode on a SmartCard TV with ScanCard II installed. When the CABLE MODE within ScanCard II is activated the TV's menu will be ignored.

**On Channel** - Press the (+) or (-) button to choose an initial Power On channel for the TV. Choose from STANDARD, AUX, VGA, SVIDEO, 2, 3, ..., 68, 69 when in the broadcast mode. Or choose STANDARD, AUX, VGA, SVIDEO, 1, 2, 3, ..., 124, 125 when in cable mode.

**On Volume** - Press the (+) or (-) button to set an initial Power On volume level for the TV. When the STANDARD option is selected, the ON VOLUME feature is disabled. When enabled, a volume "bar" will be displayed which indicates the current volume level. Pressing the (+) or (-) buttons will allow the user to change the volume to a desirable setting.

**Exit Menu** - Press the (+) or (-) button to clear the on-screen menu from the picture.

# ON-SCREEN MENU CONTROLS

## TYPICAL TV FEATURES

Depending on the model of your television and its features, some or all of the display functions and features described below will be valid. Certain feature operations which are found both in the Commercial and Consumer modes can be selected and adjusted in the same manner (such as Language, Reminder, Color Adjustments, etc.).

To perform setup operations for the TV, a T374AH remote with its TV Setup, Guest, and Data Communication mode capabilities can be used. With the use of the T374AH remote, a number of Commercial setup and verification procedures can be performed. (See T374AH Remote Control Instructions-part # IB7166E002 for details.)

### SETUP MENU

- ▷ BRIGHTNESS
- PICTURE
- COLOR
- TINT
- SHARPNESS
- CABLE
- PROGRAM
- CH ADD/DEL
- LABELS
- REMINDER
- ON CHANNEL
- POWER ON
- DISPLAYS
- KEYBOARD
- SMART SND
- INPUT
- ESP MODE
- CHAN GUIDE
- LANGUAGE
- A/V MUTE
- CHAN BLANK
- VOL FORCE
- MIN VOLUME
- MAX VOLUME
- ON VOLUME
- SPEAKER
- BASS BOOST
- VOLUME BAR
- EXIT

### DESCRIPTION OF FEATURES

**Color Adjustments** - Press the (+) or (-) button to adjust the brightness to the desired level.

Press the (+) or (-) button to adjust the picture to the desired level.

Press the (+) or (-) button to adjust the color to the desired level. Press the (+) or (-) to adjust the tint to the desired level.

Press the (+) or (-) button to adjust the sharpness to the desired level.

**Volume controls** - Press the (+) or (-) button to set the maximum allowable volume available from the keyboard or the Guest transmitter.

Press the (+) button to disable the normal functioning of the volume control. This forces the volume to the maximum level allowed by the volume lim-

iter described in the next step. In this mode the mute function is disabled. Press the (-) button for "standard volume up/down", allowing normal volume control operation.

Press the VOLUME UP or VOLUME DOWN button to set maximum level available. The range is made up of 63 steps from minimum to maximum.

Press the (+) or (-) to choose between MAX(imum) volume or the TURN ON volume. Press the VOLUME UP or VOLUME DOWN button to set either the MAX(imum) volume level available, or the set TURN ON volume level. The range is made up of 63 steps from minimum to maximum.

**Cable TV Mode** - Press the (+) button to have the TV receive cable channels 1 to 125 excluding channels 95, 96 and 97. Press the (-) button to have the TV receive the normal off-the-air channels 2-69.

**Auto Program** - This function allows the TV to scan all the channels and automatically program in memory all active channels on the system. Press the (+) button to activate auto programming. Press the (-) button at any time to stop this function.

**Add/Delete Channels** - This function allows individual channels to be added or deleted from memory. Tune the desired channel by using the CHANNEL UP/CHANNEL DOWN buttons or by random access, and then press the (+) or (-) button to either add or remove a channel from memory.

**Labels** - This function will give a name, up to eight characters, to a channel. Press the (-) button to delete any existing label. Press the (+) button to activate this function. Once in modification display, a cursor will point to the position on the label. The Menu ▲▼ buttons (on the T374AH remote) will scan through the available character set. The (+) and (-) buttons will move the cursor to the next position on the label. A total of 32 channels may be labeled. **(DO NOT LABEL S-VIDEO)**

**Reminder** - Press the (+) button to allow the continuous display of the current channel number. Press the (-) button and the channel number will appear for only a few seconds after the channel change and then disappear. **(With ScanCard II installed REMINDER should be in the OFF position.)**

**On Channel** - This function will determine what channel the TV will tune to at initial turn ON. Tune any channel and press the (+) button. The TV will tune to that channel every time it is turned ON. Press the (-) button and the TV will, at turn on, tune to the last channel tuned before turn OFF. **(Will not operate with the ScanCard II installed.)**

**Power On** - Press the (+) button for the "POWER FORCED ON" mode. This disables the normal ON/OFF control and the receiver will be activated once AC power is applied. The "Sleep Timer" function is disabled and the set may not be turned OFF except by removing power. Press the (-) button for normal "POWER ON/OFF" control.

**Displays** - The "NO DISPLAYS" function disables any on-screen displays, except the Sleep Timer and the Mute. Press the (+) button to activate this function and the (-) button for standard displays. **(With the ScanCard II installed set Displays to STANDARD.)**

**Keyboard** - The "OFF" selection lockouts or disables all functions from the TV's front control panel. **(This function will not work with the ScanCard II installed.)**

**Smart Sound** - The "ON" selection controls the TV volume to smooth out level during program changes and commercial breaks.

**ESP Mode** - The "ESP MODE" function will automatically turn OFF the set if it has been ON continuously for the time duration shown. Press the (+) button to activate the function and set the time limit by random access of the desired duration (up to 99 hours). Press the (-) button for normal TV operation.

**Channel Guide** - Press the (+) button to enable the Channel Guide feature. Press the (-) button to disable the function.

**A/V Mute** - The "ON" setting goes to a blank Video Blue background, and the TV audio is muted. "OFF" returns the TV to Antenna signal source screen.

**Channel Blank** - The "Blanked" setting allows the viewer to block the picture to any channel. Press the (+) button to "BLANKED", or the (-) button to "UNBLANKED". **(DO NOT BLANK THE S-VIDEO CHANNEL.)**

**Speaker** - The "ON" setting is selected by pressing the (+) button when SPEAKER is highlighted in the menu. This will allow the TV speakers to operate. In the "OFF" position (selected by pressing the (-) button) the TV speakers will not work and the external speaker connection on the back of the TV will be operational.

**Bass Boost** - With the BASS BOOST feature in the "ON" position the low frequency audio range of the TV is increased creating a deeper, fuller sound.

**Exit** - The "OFF" selection will drop the TV's on-screen feature list from the screen.

## CLOSED CAPTIONING

*Closed Captioning allows you to read the voice content of television programs on the TV screen. Designed to help the hearing impaired this feature uses on-screen "text boxes" to show dialogue and conversations while the TV program is in progress. This feature will not work when tuned to the VGA channel.*

### (BEGIN)

**1** Press the **CC button** on the remote control to bring up the Closed Captioning on-screen display.

**2** Press the **CC button repeatedly** to select the desired Closed Caption mode.  
For example: **CAPTION 1.**

**CAPTION 1, 2, 3, or 4:** dialogue (and descriptions) for the action on the captioned TV program shows on-screen.

**TEXT 1, 2, 3, or 4:** often used for channel guide, schedules, or bulletin board information for CC programs.

**Note:** Usually "CAPTION 1" is the most used mode to view captioned material.

**3** After making your Closed Caption mode selection the menu will time out and disappear from the screen within a few seconds.

Closed Captioning material (if available on the current selected TV program) will appear on the TV screen.

To cancel, select the OFF mode within the Closed Captioning feature.

**Note:** Not all TV programs and product commercials are made for broadcast with Closed Captioning (CC) information included.

### The Closed Caption feature does not work on the VGA channel.

Press CC/STATUS to select Closed Captioning mode CAPTION 1	Closed Captioning modes when pressing the CC button on the remote control.  CAPTION 2, CAPTION 3, CAPTION 4 or TEXT 1, TEXT 2, TEXT 3, TEXT 4 or OFF
------------------------------------------------------------------	------------------------------------------------------------------------------------------------------------------------------------------------------------------------------

## 2x ZOOM AND PAN

The Zoom feature will enlarge the on-screen display twice its normal size only when tuned to the VGA channel. Defaulting to the upper left corner, the picture can be panned by using the "cursor" keys on the remote control.

### BEGIN

- 1 When tuned to the VGA channel press the ZOOM button on the remote control. The on-screen display will appear twice as large. Defaulting to the upper left corner of the display, some of the on-screen picture will be cut off.
- 2 Press the ▲▼ buttons to pan the display UP or DOWN. Press the ◀▶ buttons to pan the display LEFT or RIGHT.
- 3 Press the ZOOM button again to bring the display back to the upper left corner. When in this position, pressing the ZOOM button once more will return the display to its original size.

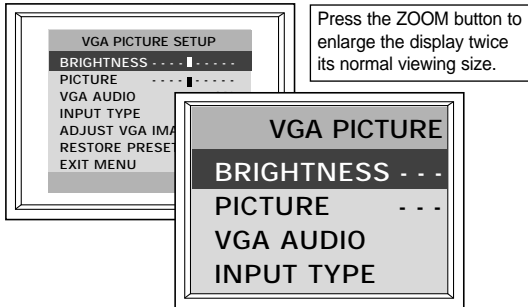

## PANNING WITH THE CURSOR KEYS

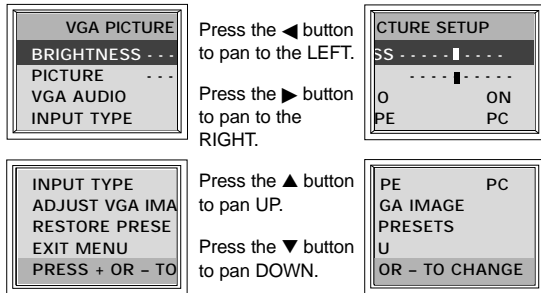

## GENERAL INFORMATION

### INDEX

Antenna Connections	10-11
Assembly of ScanCard II	6-7
Audio Connections	14-15
Cable TV Connections	12-13
Closed Captioning	35
Controls/TV	21
Description on Menu Options	
TV Picture Setup	25
VGA Picture Setup	27
VGA Image Adjustments	29
Commercial Settings	31
TV Features	32-34
Features	5
Glossary	38
Hookups	10-20
Index	37
Input Jacks	9
Installation of ScanCard II	8-9
Introduction	4
On-Screen Menu Displays	
TV Picture Setup	25
VGA Picture Setup	26
VGA Image Adjustments	28
Commercial Settings	30
TV Features	32
Output Jacks	9
Precautions	2
Remote Operation	22-23
RS 232 Connector	20
Safety Warnings	2
S-Video Inputs	16-17
S-Video Outputs	16-17
Table of Contents	3
TV Control Panel	21
Unpacking of ScanCard II	6-7
VCR Connections	13-17
VGA Inputs	18-19
VGA Outputs	18-19
Video Connections	14-15
Warranty Information	39
Zoom/Pan Feature	36



## GLOSSARY

**Audio/Video Inputs** • Connectors (RCA phono type plugs) on the rear of the TV for the input of audio and video signals.

**ClonePort** • The ClonePort jack is given priority over all functions on the ScanCard II. This port is used for cloning purposes only. The ClonePort connector is used with Settop Boxes/Data Control Modules (*To copy the internal memory settings of one SmartCard television to another with the use of a Smart Loader*).

**Coaxial Cable** • A single solid antenna wire normally matched with a metal plug (F-type) end connector that screws (or pushes) directly onto a 75 Ohm input found on the Television or VCR.

**Commercial Mode** • Mode of operation to which the TV can be set. Generally used by technicians to setup the TV's operating system.

**DCM** • Device (Data Control Module) that connects to the ClonePort and can communicate with the TV control system using the ClonePort Interface.

**Menu** • An on-screen listing of feature controls shown on the Television screen that are made available for user adjustments.

**Multichannel Television Sound (MTS)** • The broadcast standard that allows for stereo and Second Audio Programs (SAP) to be transmitted with the TV picture.

**RS 232 Connector** • Electrical Interface on the Scan Converter jack panel that allows a computer to communicate with the card control system.

**RF Input** • Or otherwise known as the Antenna Input on most televisions. The input to which a video signal (Antenna, Cable, VCR, etc.) is generally connected.

**ScanCard II** • An optional accessory that fits into a SmartCard Television allowing the use of a VGA signal.

**Scan Mode** • This is a reference to the operating mode of the SmartCard™ Television after a ScanCard™ assembly has been added.

**S-Video Input** • This input is used to obtain a high quality of video for the best possible picture viewing.

**VGA** • Abbreviation for Video Graphics Adapter. This is the type of signal that a computer generates. Also known as RGB.

## LIMITED WARRANTY



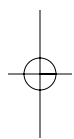
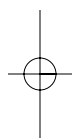

1997 © Philips Consumer Electronics Company

IB7957E001

