

User Guide

C781

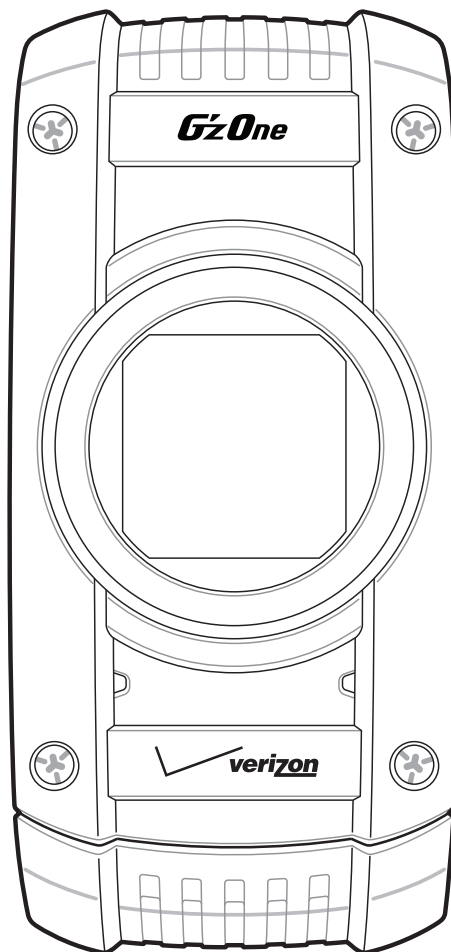

CHAPTER 1. BEFORE USING

BEFORE USING7

INSIDE THE PACKAGE.....8

HANDSET DESCRIPTIONS.....9

DISPLAY INDICATORS 12

FEATURT OVERVIEW 19

INSTALLING THE SIM CARD AND BATTERY 20

REMOVING THE BATTERY 22

CHARGING THE BATTERY..... 23

BATTERY HANDLING INFORMATION..... 24

USING A MEMORY CARD..... 25

CONNECTING TO THE HAEDSET 26

CHAPTER 2. BASIC OPERATION

BASIC OPERATION29

TURNING THE PHONE ON AND OFF..... 30

MENU ACCESS 30

MENU SUMMARY..... 31

MAKING A CALL..... 33

ABOUT PUSH TO TALK 34

USING A PUSH TO TALK (PTT) ALERT 34

USING A PUSH TO TALK (PTT) BARGE 35

ANSWERING CALLS..... 36

ANSWERING PTT CALLS..... 37

ENDING A CALL 37

MISSED CALL NOTIFICATION 37

WAIT/PAUSE..... 38

MAKING AN INTERNATIONAL CALL 39

3 WAY CALLING 39

CALL WAITING..... 39

VOLUME QUICK ADJUSTMENT 40

CALLER ID 40

VIBRATE MODE..... 40

MUTE FUNCTION 40

SPEAKERPHONE..... 41

FLASHLIGHT 41

VOICE DICTATION..... 41

TEXT TO SPEECH 42

AVAILABLE OPTIONS DURING A CALL..... 43

MAKING AN EMERGENCY CALL 43

MOTION DETECTION..... 44

CHAPTER 3. MEMORY FUNCTION

MEMORY FUNCTION.....47

STORING A PHONE NUMBER..... 48

TEXT INPUT..... 54

USING THE TEXT INPUT MODE 54

ONE, TWO, THREE DIGIT SPEED DIALING 57

CHAPTER 4. MENU FUNCTION

MENU FUNCTION.....59

- CONTACTS..... 60
- MESSAGING..... 68
- SETTINGS..... 75
- OPTIONS..... 78
- RECENT CALLS..... 78
- MEDIA CENTER..... 81
- VZ NAVIGATOR..... 86
- SETTINGS & TOOLS..... 87

CHAPTER 5. SAFETY AND WARRANTY

SAFETY AND WARRANTY131

- SAFETY INFORMATION FOR WIRELESS HANDHELD PHONES..... 132
- SAFETY INFORMATION FOR FCC RF EXPOSURE 137
- SAR INFORMATION..... 138
- HEARING AID COMPATIBILITY (HAC) FOR WIRELESS TELECOMMUNICATIONS
DEVICES..... 140
- FDA CONSUMER UPDATE 141
- AVOID POTENTIAL HEARING LOSS 150
- FCC COMPLIANCE INFORMATION..... 152
- 12 MONTH LIMITED WARRANTY 153

BEFORE USING **1**

This chapter provides important information about using the C781 including:

- INSIDE THE PACKAGE
- HANDSET DESCRIPTIONS
- DISPLAY INDICATORS
- FEATURT OVERVIEW
- INSTALLING THE SIM CARD AND BATTERY
- REMOVING THE BATTERY
- CHARGING THE BATTERY
- BATTERY HANDLING INFORMATION
- USING A MEMORY CARD
- CONNECTING TO THE HAEDSET



C781

INSIDE THE PACKAGE

This package should include all items pictured below. If any are missing or different, immediately contact the retailer where you purchased the phone.

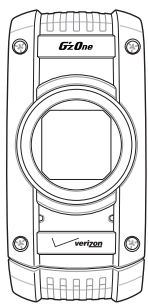

Handset



Standard Battery



SIM Card (Pre-installed)

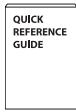

QRG (Quick Reference Guide)



Product Safety & Warranty Guide

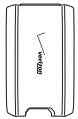

Battery Cover

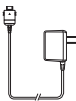

Wall Charger



USB Cable



Global Support Kit

HANDSET DESCRIPTIONS

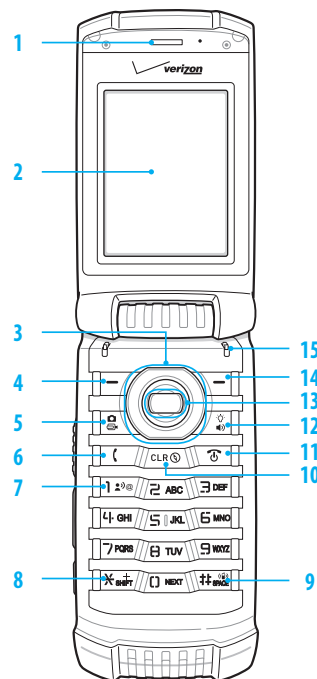

1. **Earpiece:** Allows you to hear the other caller.
2. **Main Display Screen:** Displays all the information needed to operate your phone.
3. **[] Directional Key:** Allows you to scroll through phone menu options and provides a shortcut to phone functions from idle mode.
4. **[] Left Soft Key:** Press to access the messaging menu or access the function listed above the key.
5. **[] Camera & Video Key:** In idle mode, press once to start taking a picture. If pressed one more time, it toggles to the video recording mode.
6. **[] SEND Key:** Press to make or receive a call. In idle mode, press to access the all calls list.

01
02
03
04
05

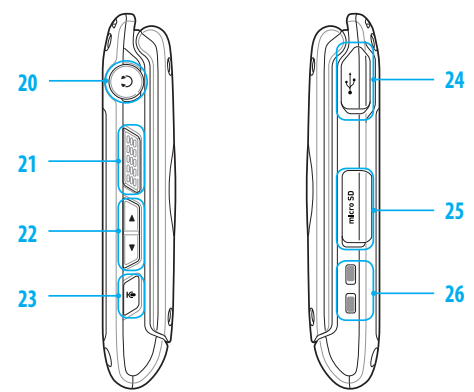
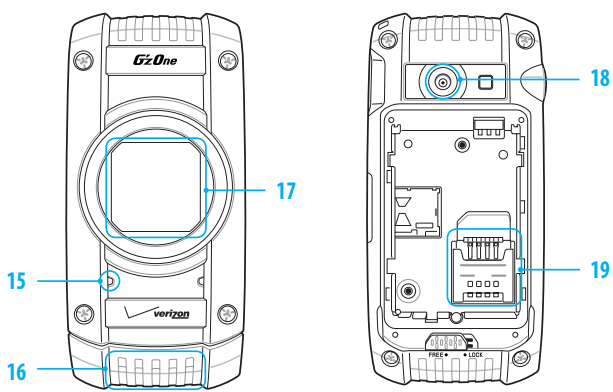



















7. [] **Voicemail Key:** In idle mode, press and hold to automatically connect to your voicemail box.
8. [] **Shift Key:** Press to enter an asterisk (*) character for calling features. In text entry mode, press to change the character input type. Press and hold to display the plus sign (+) for international dialing.
9. [] **Vibrate Mode Key:** Press and hold to activate/deactivate vibrate mode in idle mode. Press to enter the (#) character for calling features. In text entry mode, press to add a space.
10. [] **CLR Key:** Press to clear a character from the display. Press and hold to clear all characters. Within a menu, press to return to the previous menu. Press and hold to activate the GzGEAR function in idle mode.

11. [] **END/PWR Key:** Press and hold to turn the phone on/off or press to end a call or browser session. Within a menu, press to return to idle mode.
12. [] **Speakerphone / Flashlight Key:** With the flip open, press to turn speakerphone on or off.
13. [] **OK Key:** Press to access the menu from idle mode. It also allows you to accept choices when navigating through the menu.
14. [] **Right Soft Key:** Press to access the contacts menu in idle mode or access the function listed above the key.
15. **Microphone:** Allows the other caller to hear you.
16. **External Speaker:** Allows you to listen to music, sounds or ringtones.















17. **Front Display Screen:** Displays incoming calls, messages, signal, battery strength, time and date.
18. **Camera:** Built-in camera lens.
19. **Sim Card Slot:** Allows you to insert a SIM card. The SIM Card comes pre-installed in the device (located under the battery).
20. **Headset Jack:** Allows you to plug in an optional headset for convenient, hands-free conversations.
21. **[PTT] PTT Key:** Press to activate the PTT mode in idle mode.
22. **[Volume] Volume Keys:** Press to adjust the master volume in idle mode or adjust the voice volume during a call.
23. **Voice Command Key:** Press to activate the voice command function in idle mode.
24. **Charging / Data Jack:** Plug in a wall charger or USB cable (USB cable sold separately).
25. **SD Card Slot:** Allows you to insert a SD card.
26. **Charging Terminals**

DISPLAY INDICATORS



Main Indicator Icons	
	1X Signal Strength: 1X service is available.
	3G Signal Strength: 3G service is available.
	D Signal Strength: Digital service is available.
	GSM Signal Strength: GSM service is available.
	GPRS Signal Strength: GPRS service is available.

Main Indicator Icons	
	Airplane Mode: Transmitting and receiving information is restricted.
	1x and PTT services are available.
	3G and PTT services are available.
	Roaming: The phone is outside of the home service area.
	Femto Cell: The phone is connected to the network extender.(Femto Cell).
	SSL (Secured Socket Layer): Indicates that secure communication between client and server has been established during data communication using encryption.
	Voice Privacy: Indicates Voice Privacy mode is active.
	Data Call: Data Session is in progress.
	Dormant: Phone is in a dormant state during a data call. Phone reverts to Dormant mode when there hasn't been activity on a page for some time. The connection is still active and you can make and receive calls.
	No Service: Phone cannot receive a signal from the system.
	TTY: TTY mode is active.
	Voice Call: A call is in progress. * No icon indicates the phone is in idle mode.
	GPS E911 Icon: Location Service of your phone is E911.
	GPS Location On Icon: Location Service of your phone is Location On.











Main Indicator Icons

	Bluetooth: Indicates Bluetooth mode.
	Bluetooth Active: Indicates Bluetooth Active mode.
	Bluetooth Connected: Indicates a Bluetooth Device is connected.
	Battery Level: Battery charging level - the more blocks, the stronger the charge.
	AVR Active: AVR mode is active.
	AVR Listening: Indicates AVR listening.
	SIM Card: Indicates SIM Card memory in use.
	All Sounds Off: All sounds are set to off.
	Alarm Only: Phone will alert you only with an alarm alert.
	Vibrate Only: Phone will vibrate when call is received.
	Speakerphone: Speakerphone mode is active.
	Missed Calls: Indicates you have missed calls.
	Message: Indicates you have a new message.
	Email: Indicates you have received a new email.
	Calendar Appointment: Event Alarm is active.

Main Indicator Icons

	Voicemail: Indicates you have voicemail messages.
	Alarm On: Appears when an alarm is set.
	DST: DST (Daylight Saving Time) is active.

PTT Icons

	PTT Individual Available
	PTT Group Available
	PTT Unavailable
	Do Not Disturb_Single
	Do Not Disturb_Group
	PTT Number
	PTT Group
	PTT Alert
	PTT Missed calls
	PTT Connecting to Individual
	PTT Connected to Individual

01

02

03

04

05























PTT Icons	
	PTT Connecting to Group
	PTT Connected to Group
	PTT Listening to Individual
	PTT Talking to Individual
	PTT Listening to Group
	PTT Talking to Group
	PTT Call Ended
	PTT Enterprise Group Dialed
	PTT Enterprise Group Received
	PTT Individual DND
	PTT Group DND
	PTT Enterprise Group DND

Recent Call Icons			
	Dialed Call		Missed Call
	Received Call		

New Contact Icons			
	Mobile1		Ringtone
	Mobile2		FAX
	Home		Speed Dial
	Business		Voice Dial
	Personal Email		Address
	Business Email		WL Messenger
	Group		AIM
	Picture		Yahoo!
	Message Tone		Title
	IM Screen Name		Birthday
	Company		Notes

Message Icons			
	New/Unread Message		Priority
	Opened/Read Message		Unopened Message Notification

Message Icons

 Unread EMS	 Opened Download Picture Message
 Read EMS	 Corrupt Message
 Message Delivered	 Pending Message Sent
 Incomplete Delivery	 Unread MMS
 Sent Message Delivery Failed	 Read MMS
 Message Locked	 Sent Message
 Text Message Draft	 Received Message
 Picture Message Draft	 Unread WAP Push
 Read WAP Push	 Multiple Message Pending
 Multiple Message Delivered	 Multiple Message Sent
 Multiple Message Failed	 Multiple Message Incomplete

FEATURE OVERVIEW

WATER RESISTANCE

The C781 is water resistant. It provides reliable performance for outdoor activities, and in wet conditions such as driving rain or high humidity.

The tested devices meets the requirements of the MIL-STD-810G (Rain & immersion 1m, 30min) standard.

 **CAUTION:** The Water Resistance feature does not guarantee protection against the usage of this device underwater. Do not use the handset underwater.

 To maintain water resistance:

- Securely close the Charging/Data Port cover and the Headset Jack cover.
- Completely close the battery cover and slide the battery cover lock to the LOCK position.

SHOCK RESISTANCE

The rugged construction of the Ravine™ provides outstanding shock and vibration resistance. The tested device meets the requirements of the MIL-STD-810G (Drop 1.5m) standard.

 **CAUTION:** The shock and vibration resistance features do not guarantee protection against every type of shock and vibration. Your handset may be damaged or malfunction depending on the severity of the shock or vibration.

DUST RESISTANCE

For additional peace of mind, the Ravine™ is also dust resistant. The device was tested using silica flour at a temperature of 95°F and meets the MIL-STD-810 (Dust) standard.

 Your handset can be rinsed with clean water when dirty. To ensure water resistance, make sure that all covers are securely closed before rinsing.

- Periodically, clean the Charging Terminals and Battery Terminals with a dry cloth or cotton swab. Dust may cause electrical connection problems. Avoid wiping with excessive force, which can damage the terminals.

01

02

03

04

05

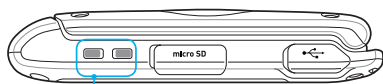

Charging Terminals

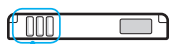

Battery Terminals

CAUTION

- Do not clean terminals inside the handset, or they may be damaged.
- If mud or sand is adhered to the handset, do not use it until wiping completely.
- Do not place the handset directly on sand. If sand gets into the Earpiece or Speaker, sounds may be difficult to hear. Sand getting into the handset's hinge can cause problems such as overheating.

INSTALLING THE SIM CARD AND BATTERY

Your wireless device comes with a SIM card installed which along with a Global Feature on your account, enables you to make calls and access email in GSM Networks while traveling overseas.

Should your SIM card be lost or damaged, please follow these instructions for the installation of your new SIM.

1. Slide the SIM card into the slot in the direction of the arrow shown in the figure.
 - To remove the SIM card, pull out the SIM card in the opposite direction of the arrow.

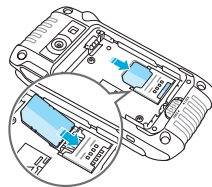

BEFORE USING

2. Slide the battery into the slot by aligning the contacts (1) and press down until you hear "click (2)."

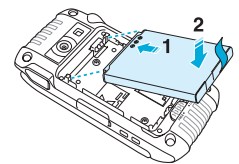

3. Insert the battery cover into the slots (1) and press the battery cover in the direction of the arrow (2).

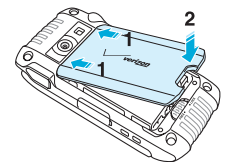

4. Press down firmly on the side of the battery cover at each arrow points, as shown in the figure.

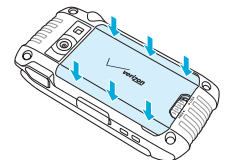

5. Slide the battery cover latch to the LOCK position in the direction of the arrow shown in the figure.

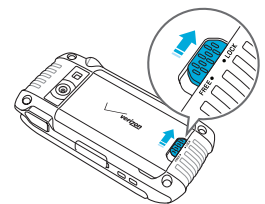

01
02
03
04
05

REMOVING THE BATTERY

1. Slide the battery cover latch to the FREE position in the direction of the arrow as shown in the figure.

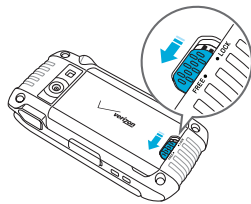

2. Insert your finger in the groove and pull up the battery cover in the direction of the arrow.

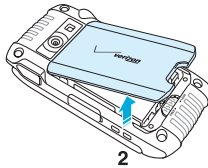

3. Remove the battery by pulling the tab up.

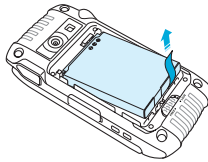
**CHARGING THE BATTERY**

1. Connect the USB data cable into the cableless wall adapter.
2. Plug the USB data cable into the phone's charging/data jack and the wall adapter end into an electrical outlet.

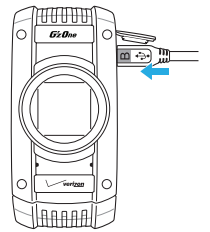

 If the battery connector is not properly aligned, damage could occur to the charging connector and the phone may not be charged.

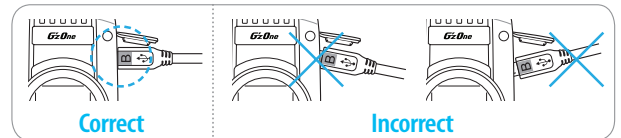
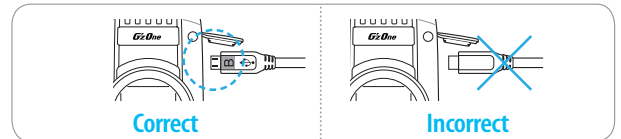

3. To remove the wall charger, unplug the USB data cable from the phone's charging/data jack.

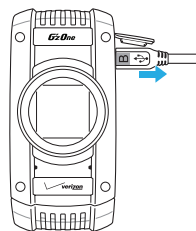

- When you charge the battery with the handset powered off, you will see a charging status screen. After charging is completed, the Charge Complete message appears and you cannot operate the phone until it is powered on. To turn your phone on, press and hold the Power Key until your display turns on.
- The battery may not be fully charged at the time of purchase. Fully charge the battery before using.
- It is more efficient to charge the battery with the handset powered off.
- Battery operating time gradually decreases over time.
- If the battery fails to perform normally, you may need to replace the battery.

BATTERY HANDLING INFORMATION

DO'S

- Only use the battery and charger approved for use with the C781.
- Only use the battery for the system for which it is specified.
- Only use or replace the battery with a charging system or another battery that has been qualified with the system per this standard, IEEE-Std-1725-2006. Use of an unqualified battery or charger may present a risk of fire, explosion, leakage, or other hazard.
- Only use the battery for its original purpose. As an improper battery use may result in a fire, explosion or other hazard.
- Try to keep batteries in a temperature between 41°F (5°C) and 95°F (35°C). If the battery is stored in temperatures above or below the recommended range, give it time to warm up or cool down before using.
- Store the discharged battery in a cool, dark, and dry place.
- Purchase a new battery when its operating time gradually decreases after fully charging.
- Properly and promptly dispose of the battery according to local laws.
- Battery usage by children should be supervised.

DON'TS

- Don't attempt to disassemble or open the battery – it is a sealed unit with no serviceable parts.
- Don't crush, bend or deform, puncture or shred the battery.
- Don't drop the phone or battery. If the phone or battery is dropped, especially on a hard surface, and the user suspects damage, take it to a service center for inspection.
- Don't leave the battery in extremely hot or cold temperatures. Otherwise, it could significantly reduce the capacity and lifetime of the battery.
- Don't modify or remanufacture, attempt to insert foreign objects into the battery, immerse or expose to water or other liquids, expose to fire, explosion or other hazard.
- Don't accidentally short-circuit the battery by carrying it in your pocket or purse with other metallic objects such as coins, clips and pens. This may critically damage the battery.
- Don't short-circuit a battery or allow metallic conductive objects to contact battery terminals.
- Don't dispose of the battery by placing into a fire.

USING A MEMORY CARD

The C781 supports the use of a microSD™ memory card as a source of external memory.

USING A MICROSD™ CARD

By using a microSD™ card, you can store sounds, videos, images, photos, music, and other files.

USING A MICRO SD™ CARD (OPTIONAL)

1. Open the microSD™ card cover, and insert the microSD™ card into the slot with the gold contacts facing up.
2. Press the microSD™ card into the slot until you hear the "click," then close the microSD™ card cover.
3. "SET MEMORY CARD AS DEFAULT STORAGE LOCATION?" will appear on the display.

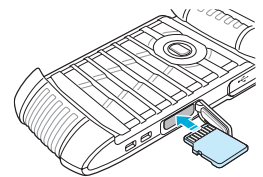



- Press the OK Key to confirm.

 To prevent possible damages, please keep the microSD™ card slot closed at all times regardless of whether a microSD™ card is inserted or not.

REMOVING A MICROSD™ CARD

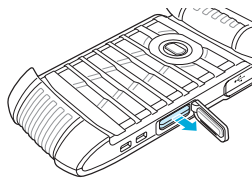
- Open the microSD™ card cover, and use your thumb to press and release the microSD™ card.
- Press the memory card inward, gently, until it pops out.
- Remove the microSD™ card and close the microSD™ card cover.



-  Do not remove the microSD™ card while reading or writing files. Otherwise it could be damaged.
- To ensure the proper function of removable memory, please use a microSD™ card.

CONNECTING TO THE HEADSET

You can connect a compatible device equipped with a standard 2.5mm plug to your handset for safe, convenient, hands-free conversations.

- To open the headset jack cover, insert your fingertip into the notch and open the cover.
- Plug the connector into the headset jack.

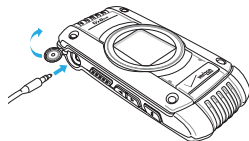

CAUTION

- Do not forcibly insert/remove the connector into/from the headset jack. Carefully insert/remove it.
- Failure to completely reseal the headset jack cover after use may result in damage if the handset is exposed to water.

01

02

03

04

05

BASIC OPERATION **2**

This chapter addresses and explains the basic features for C781 including:

- TURNING THE PHONE ON AND OFF
- MENU ACCESS
- MENU SUMMARY
- MAKING A CALL
- ABOUT PUSH TO TALK
- USING A PUSH TO TALK (PTT) ALERT
- USING A PUSH TO TALK (PTT) BARGE
- ANSWERING CALLS
- ANSWERING PTT CALLS
- ENDING A CALL
- MISSED CALL NOTIFICATION
- WAIT/PAUSE
- MAKING AN INTERNATIONAL CALL
- 3 WAY CALLING
- CALL WAITING
- VOLUME QUICK ADJUSTMENT
- CALLER ID
- VIBRATE MODE
- MUTE FUNCTION
- SPEAKERPHONE
- FLASHLIGHT
- VOICE DICTATION
- TEXT TO SPEECH
- AVAILABLE OPTIONS DURING A CALL
- MAKING AN EMERGENCY CALL
- MOTION DETECTION



C781

TURNING THE PHONE ON AND OFF

TURNING ON

1. Press and hold the END/PWR Key  until the phone display turns on.
2. Enter your 4-digit lock code if the phone is locked.

 The default lock code is the last 4 digits of your phone number.





TURNING OFF

1. Press and hold the END/PWR Key  until the phone display turns off.

-  Immediately change or recharge the battery when **BATTERY LOW** appears on the display.
Memory may possibly be damaged if the phone turns off due to the battery completely draining.
- Turn the phone off before removing or replacing the battery. If the phone is on, unsaved data may be lost.

MENU ACCESS

Your phone can be customized via the menu. Each function can be accessed by scrolling with the Directional Key or by pressing the number that corresponds with the menu item.

1. To access the menu, press the OK key **[MENU]**.
2. To scroll through the menu, press the Directional key  up, down, left or right.
3. To return to the previous page, press the CLR key .
4. To exit the current menu, press the END/PWR Key .
5. To access the messaging menu, press the Left Soft Key  **[Message]**.
6. To access the contact list, press the Right Soft key  **[Contacts]**.

 All directions in this manual are based on the list and communicator menu layout and the world display theme. If you have changed the settings, the directions may vary.

MENU SUMMARY

Main Menu	2nd DEPTH	3rd DEPTH
Contacts	1. New Contact	
	2. Contact list	
	3. Groups	
	4. New PTT Contact	
	5. PTT Contact List	
	6. PTT Group	
	7. Backup Assistant	
	8. Speed Dials	
	9. In case of Emergency	
	10. My Name Card	
Messaging	1. New Message	Text Message Picture Message Video Message Voice Message
	2. Inbox	
	3. Sent	
	4. Drafts	
	5. Voicemail	
	6. Mobile IM	
	7. Mobile Email	
Recent Calls	1. Missed	
	2. Received	
	3. Dialed	
	4. All	
	5. View Timers	



Main Menu	2nd DEPTH	3rd DEPTH
Media Center	1. Apps	
	2. Mobile Web	
	3. Tunes & Tones	1. My Ringtones 2. My Sounds
	4. Picture & Video	1. V CAST Videos 2. My Pictures 3. My Videos 4. Take Picture 5. Record Video 6. Online Album
Mobile Email		
Apps		
My Pictures		
Settings & Tools	1. My Verizon	
	2. Master Volume	
	3. Tools	
	4. Bluetooth	
	5. Keyguard Settings	
	6. PTT Settings	
	7. Sound Settings	
	8. Display Settings	
	9. Phone Settings	
	10. Call Settings	
	11. Memory	

Main Menu	2nd DEPTH	3rd DEPTH
	12. USB Mode	
	13. Phone Info	
	14. SIM Info	
	15. Data Manager	
	16. Tutorial	
	17. Set Up Wizard	

- 01
- 02
- 03
- 04
- 05

MAKING A CALL

BY DIALING THE PHONE NUMBER

1. First, gently open the folding cover of the phone.
2. Enter the phone number including the area code if needed and press the SEND Key .
3. To end the call, press the END Key .

 When you place or receive a call from phone numbers stored in your Contact List, the name will be displayed.

USING THE SPEED DIALING FUNCTION

1. If the speed dial is set, press the speed dial number you wish to connect to, and hold the last digit number you have assigned for the speed dial. "Speed Dial" message appears, and your call is connecting to the contact.
2. To end the call, press the END Key .

USING THE CONTACT LIST

1. Press the Right Soft Key  [Contacts].
2. Select the contact and press the SEND Key .
3. To end the call, press the END Key .

ABOUT PUSH TO TALK

Push to Talk calls may only be made with other Verizon Wireless Push to Talk subscribers, and only from the National Enhanced Services Rate and Coverage Area. A Push to Talk call is terminated by pressing the End/Power Key  or will automatically time out after 10 seconds of inactivity. While you are on a Push to Talk call, voice calls received will go directly to Voice Mail. When you are on a voice call, you cannot receive a Push to Talk call. You cannot prevent others who have your wireless phone number from entering you into their Push to Talk Contact List. Only one person can speak at a time during Push to Talk calls. When using your phone keypad to make a Push to Talk call, you must enter the 10-digit phone number of the called party. Your Push to Talk service cannot be used for any applications that tether your phone to computers or other devices for any purpose. Push to Talk-capable phone and Calling Plan required. If you wish to switch from a Push to Talk Calling Plan to another Calling Plan, you must first stop using your Push to Talk-capable phone and purchase or provide another compatible phone.

USING A PUSH TO TALK (PTT) ALERT

The Push To Talk (PTT) feature allows you to use your phone like a walkie-Talkie to communicate with Verizon Wireless PTT subscribers.

An alert call is a call to notify a called party that the calling party wants to talk using a tone. The called party has option to answer or ignore the call.

BY DIALING THE PHONE NUMBER

1. Enter the phone number including the area code if needed and press the Left Soft Key **[Alert]**.

“Press PTT Key To Alert” message appears on your main display screen.





 The Left Soft Key **[Alert]** is not available when **PTT Mode** is set to **Off**.

2. Press the PTT Key  on your left hand side of the phone to alert.

3. Keep pressing the PTT Key  while talking and then release the PTT Key .





Release the PTT Key  to let the other party talk.

USING THE SPEED DIALING FUNCTION

1. If the speed dial is set, press the speed dial number you wish to connect to. “Assisted dialing On” message appears.
 2. Press the PTT Key  on your left hand side of the phone to alert.
 3. Keep pressing the PTT Key  while talking and then release the PTT Key .
- You can hear the response while the PTT Key  is released.

 For information about using the speed dial, see page 63.

USING THE CONTACT LIST

1. Press the Right Soft Key  **[Contacts]**.
 2. Select the contact and press the Left Soft Key  **[Alert]**. “Press PTT Key To Alert” message appears on your main display screen.
 3. Keep pressing the PTT Key  while talking and then release the PTT Key .
- You can hear the response while the PTT Key  is released.

 The phone number you are trying to alert must be saved in the PPT Contact List.

USING A PUSH TO TALK (PTT) BARGE

A barge call automatically connects to the other party. The called party does not have the option to ignore the call.

BY DIALING THE PHONE NUMBER

1. Enter the phone number including the area code if needed.
2. Press and hold the PTT Key  on your left hand side of the phone.



01

02





03

04

05





3. Wait until the "OK to Talk" tone sounds and the message "Talking to" appears on the display. Speak while pressing down PTT Key .
4. Release the PTT Key  to let the other party talk.
5. Press the END Key  to end the call.

USING THE SPEED DIALING FUNCTION

1. If the speed dial is set, press the speed dial number you wish to connect to. "Assisted dialing On" message appears.
2. Press and hold the PTT Key  on your left hand side of the phone.
3. Wait until the "OK to Talk" tone sounds and the message "Talking to" appears on the display. Speak while pressing down PTT Key .
4. Release the PTT Key  to let the other party talk.
5. Press the END Key  to end the call.

 For information about using the speed dial, see page 63.

USING THE CONTACT LIST

1. From the idle mode, press the PTT Key  to access your PTT contact List.
2. Press and hold the PTT Key  on your left hand side of the phone.
3. Wait until the "OK to Talk" tone sounds and the message "Talking to" appears on the display. Speak while pressing down PTT Key .
4. Release the PTT Key  to let the other party talk.
5. Press the END Key  to end the call.

 The phone number you are trying to alert must be saved in the PPT Contact List.

ANSWERING CALLS

1. Press the SEND Key  to answer the incoming call.



 Depending on your phone's settings, you may also answer incoming calls by opening the phone or by pressing any key.

2. To ignore incoming calls, press the Right Soft Key  [Ignore].

ANSWERING PTT CALLS





INCOMING A BARGE CALL

When you receive a barge call, you will hear the calling party speaking through the speakerphone. The calling party's phone number will appear on your display. If the calling party's number has already been registered in your PTT Contact List, the contact name will replace the phone number on the display.

1. Press and hold the PTT Key  to talk.
2. Release the PTT Key  to let the other party talk.
3. Press the End Key  to end the call.

INCOMING AN ALERT CALL

When you receive an alert, you will hear the "PTT Alert" tone. The message "Incoming Alert" will be displayed with the phone number or contact name of the calling party. The PTT Alert tone repeats every 1 second until you answer or ignore the call. If you do not answer an incoming alert within 10 seconds, the PTT call will be automatically disconnected.

1. Answer or ignore the alert.
 - To answer the alert, press and hold the PTT Key  and begin talking.
 - To ignore the alert, press the Right Soft Key  [Ignore].
2. Release the PTT Key  to let the other party talk.
3. Press the End Key  to end the call.

ENDING A CALL

1. Press the END/PWR Key .

MISSED CALL NOTIFICATION

When an incoming call is not answered, the missed call notification appears on the display.

DISPLAY THE MISSED CALL FROM THE NOTIFICATION

1. Select **View Now** and press the OK Key.
2. To dial the phone number, press the SEND Key .

DISPLAY A MISSED CALL FROM IDLE MODE



1. Press the OK Key **[MENU]**, select **Recent Calls** and press the OK Key.
2. Select **Missed** and press the OK Key.
3. Select the missed call and press the OK Key **[OPEN]**.
4. To dial the phone number, press the SEND Key .

WAIT/PAUSE

Pauses are used for automated systems (i.e., voice mail or calling cards). The numbers entered after the pause will automatically be dialed after the pause. It is useful for dialing into systems that require a code.



WAIT

The phone stops dialing until you press the SEND Key  to dial the next number.



1. Enter the phone number.
2. Press the Right Soft Key  **[Options]**.
3. Select and select **Add Wait** and press the OK Key.
4. Enter additional number(s).
5. Press the SEND Key  to dial.

2-SEC PAUSE

The phone waits 2 seconds before sending the next digits automatically.

1. Enter the phone number.
2. Press the Right Soft Key  **[Options]**.
3. Select **Add 2-Sec Pause** and press the OK Key.
4. Enter additional number(s) (pin number or credit card number).
5. Press the SEND Key  to dial.



MAKING AN INTERNATIONAL CALL

1. Press and hold the Shift Key .
 - The "+" symbol, required for international calls appears.
2. Enter the country code, area code, and phone number.
3. Press SEND Key  to make a call.

 When **Assisted Dialing** is set to **On**, the inputted phone numbers may change to the wrong number by the auto-correct function.

3 WAY CALLING



You can talk to two participants at the same time. During the call, the normal airtime rates will be applied for each of the two calls.

1. Enter the phone number and press the SEND Key .
2. When you have connected, enter the second phone number to call and press the SEND Key .
3. When you're connected to the second party, press the SEND Key  again to begin your 3-Way call.

 If one of the participants hangs up during the call, you and the remaining participant stay connected. If you initiated the call and are the first one to hang up, all three calls are disconnected.

CALL WAITING

If you are on a call and you receive another incoming call, you will hear one beep and the caller's phone number will appear on the display. With Call Waiting, you may put the active call on hold while you answer the other incoming call.

1. Press the SEND Key  to answer the other call. The first call will automatically be placed on hold. To switch back, press the SEND Key  again.

VOLUME QUICK ADJUSTMENT

ADJUSTING THE MASTER VOLUME

1. Press the Volume Keys to adjust the master volume level.
 - To check the ringtone's volume, press the Left Soft Key [Play].
2. Press the OK Key [SET] to save.

ADJUSTING THE VOLUME DURING A CALL

1. To increase the volume, press the Volume Keys up.
2. To decrease the volume, press the Volume Keys down.

CALLER ID

Caller ID displays the name and the phone number of the person calling. If the caller's information is not stored in your contact list, only the phone number is displayed.

VIBRATE MODE

Vibrate mode mutes the tones and activates an alert for an incoming call or message.

1. To activate, press and hold the Vibrate Mode Key .
2. To deactivate, press and hold the Vibrate Mode Key again.

MUTE FUNCTION

If you activate the mute function while you are talking on the phone, the person you are speaking with cannot hear any sounds from you but, you are still able to hear them. To activate mute function:

1. During a call, press the Left Soft Key [Mute].
2. Press the Left Soft Key [Unmute] to deactivate the mute function.

SPEAKERPHONE

The Speakerphone feature lets you hear audio through the speaker and talk without holding the phone.

1. To activate, with the flip open, press the Speakerphone Key .
- To deactivate, press the Speakerphone Key again.

If you activate the speakerphone when you are not on a call, it will deactivate automatically after one minute.

FLASHLIGHT

Your phone provides you of the flashlight function. To activate the flashlight:

1. In the idle mode, press and hold the Speakerphone / Flashlight Key .
- The flashlight turns on.
2. Press and hold the Speakerphone / Flashlight Key to deactivate the flashlight.
 - The flashlight turns off after "Flash Off" message appears on the display.

VOICE DICTATION

By using the voice dictation function, you can input the text by speaking your words instead of using the keypad.





1. Press and hold the Voice Command Key , and speak into the handset.
2. When entered text is correct, press the OK Key to confirm. If incorrect, amend the text by using the keypad. For details on how to use keypad, see page 54, "TEXT INPUT."

• Voice dictation mode cannot be used when the Bluetooth® connection is in use.
• The voice dictation function supports US English only.

TEXT TO SPEECH



READING OUT UNREAD MESSAGES WHEN THE FLIP OPEN

With the flip open, the handset reads out the text information with a synthetic voice.

1. With the flip open in the idle mode, press and hold the Voice Command Key .
 - The handset reads out unread received messages one after another for you with a synthetic voice.
2. Press the Left Soft Key  [Again] to go back to the top of the message currently being read.
3. Press the OK Key [REPLY] to create a reply message for the currently reading message.
4. Press the Right Soft Key [Options] to select the desired options.
5. Press the CLR Key  to stop reading out.
6. The handset returns to idle mode when reading out is done for all the unread messages or when the END/Power Key  is pressed to abort reading.

READING OUT UNREAD MESSAGES WHEN THE FLIP CLOSED

With the flip closed, the handset reads out the text information with a synthetic voice.

1. With the flip closed, press and hold the Voice Command Key .
 - The handset reads out unread received messages one after another for you with a synthetic voice.
2. The handset returns to idle mode when reading out is done for all the unread messages or the Voice Command Key  is pressed to unlock the side keys of handset and then the Voice Command Key  is pressed again to abort reading.

 Reading out will continue even when the flip is opened while reading out is in progress.

AVAILABLE OPTIONS DURING A CALL

During a phone call, you can access the following features by pressing the Right Soft Key  [Options]. Press the OK Key to select any of the following options:

- New Message
- Contact List
- Recent Calls
- Bluetooth Menu
- Main Menu
- Notepad
- Voice Record
- Voice Privacy

MAKING AN EMERGENCY CALL

The 911 feature automatically places the phone in Emergency Call Mode when you dial the preprogrammed emergency number, 911. It also operates in Lock Mode and out of the service area.

MAKING AN EMERGENCY CALL IN LOCK MODE

1. Enter any of the numbers **911**, ***911**, **#911** or **112** and press the SEND Key .

 The phone maintains Emergency Mode for 5 minutes. When the call ends, the phone returns to Lock Mode.

01

02

03

04

05

MAKING AN EMERGENCY CALL IN ANY NETWORK MODE

1. Enter any of the numbers **911**, ***911**, **#911** or **112** and press the SEND Key . In **ALL NETWORK MODE - CDMA Mode, GSM Mode and Global Mode**.

 The phone will stay in Emergency Mode for 5 minutes. While the phone is in Emergency Mode, the phone can receive an incoming call from any available system or you can make outgoing calls even in the Emergency Callback Mode. In this case, making a call can automatically end the Emergency Callback Mode.

 The 911 call does not appear in the recent calls list.

MOTION DETECTION

Using the Motion Detection function, you can control your handset just by shaking it.

By default, the Motion Detection function is set to **OFF**. To use the Motion Detection function:

1. From idle mode, press the OK key [**MENU**] and select **Settings&Tools**, then press the OK key.
2. Select **Phone Settings** and press the OK key, and select **Motion Detection** then press the OK key.
3. Select **G'zGEAR** or **My Pics/Videos**.
4. Select **On** or **Off** and select OK key.

When shaking the handset, be sure to hold the handset firmly as shown in the figure and shake it from the right to left or vice versa.

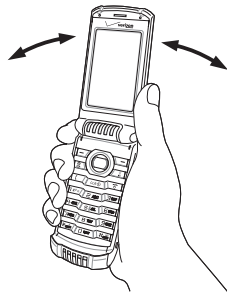

 When shaking the handset, make sure you do not hit the handset against nearby objects.

MEMORY FUNCTION 3

This chapter addresses memory functions including:

STORING A PHONE NUMBER

TEXT INPUT

USING THE TEXT INPUT MODE

ONE, TWO, THREE DIGIT SPEED DIALING



C781

STORING A PHONE NUMBER

ADDING A NEW CONTACT

1. Enter the phone number you want to save.
2. Press the Right Soft Key \mathbb{R} [Option].
3. Select **SAVE TO CONTACTS** and press the OK Key.
4. Select **Add New Contact** and press the OK Key.
5. Enter the name of contact, and the phone number.
 - You can also store the additional information such as the fax number, email address, and birthday information.
6. Press the OK Key [SAVE].

 Select Update Existing to add another phone number to a contact already stored in memory.

STORING A PHONE NUMBER INTO SIM CARD

You can copy or move the contact information to SIM card.
SIM card can store Up to 5 contacts entries.

1. Press the Right Soft Key \mathbb{R} [Contacts] and select the contact you would like to copy or move.
2. Press the Right Soft Key \mathbb{R} [Options].
3. Select [Copy & Move] and press the OK Key.
4. Select either [Move to SIM] or [Copy to SIM] and then press the OK Key.

OPTIONS TO CUSTOMIZE YOUR CONTACTS

Once the basic phone number and name information is stored in your **Contacts**, you can edit and/or customize the entries.

1. Press the Right Soft Key \mathbb{R} [Contacts] and select the **Contact** you would like to edit.
2. Press the Left Soft Key \mathbb{L} [Edit].
3. Edit the information and press the OK Key [SAVE] to save.

ADDING OR CHANGING GROUPS

To organize your Contacts into groups:

1. Press the Right Soft Key \mathbb{R} [Contacts], then select the Contact you want to add to a group.
2. Press the Left Soft Key \mathbb{L} [Edit].
3. Select **Group**, press the Left Soft Key \mathbb{L} [Set].
4. Select either **Personal** or **Business** and then press the OK Key [MARK].
5. Press the Left Soft Key \mathbb{L} [Done].
 - To create a new group, press the Right Soft Key \mathbb{R} [New], and then press the OK Key [SAVE] after entering the group name.

CHANGING THE CALL RINGTONE & MESSAGE TONE

You can identify who is calling by setting different ringtones for different phone numbers in your Contacts.

1. Press the Right Soft Key \mathbb{R} [Contacts], then select the Contact whose ringtone you want to edit.
2. Press the Left Soft Key \mathbb{L} [Edit].
3. Select **Ringtone** or **Message Tone** and press the Left Soft Key \mathbb{L} [Set].
4. To listen to the selected tone, press the Left Soft Key \mathbb{L} [Play].
To stop press the Left Soft Key \mathbb{L} [Stop]. To select, press the OK Key.
5. Press the OK Key [SAVE] to save.

ADDING OR CHANGING THE PICTURE ID

To select a picture or graphic to assign to a Caller ID:

1. Press the Right Soft Key \mathbb{R} [Contacts], then select the Contact you want to edit.
2. Press the Left Soft Key \mathbb{L} [Edit].
3. Select the **Picture** and press the Left Soft Key \mathbb{L} [Set].
4. Select and select the picture to set.

5. To view the selected picture press the Left Soft Key [View].
6. Press the OK Key to select the image.
7. Press the OK Key [SAVE] to save.

ADDING OR CHANGING AN EMAIL ADDRESS

To add or change an email address:

1. Press the Right Soft Key [Contacts], then select the Contact you want to edit.
2. Press the Left Soft Key [Edit].
3. Select **Personal Email** or **Business Email** to edit.
4. Enter the new email address and press the OK Key [SAVE] to save.

ADDING OR CHANGING HOME ADDRESS /WORK ADDRESS

To add or change address information:

1. Press the Right Soft Key [Contacts], then select the Contact you want to edit.
2. Press the Left Soft Key [Edit].
3. Select **Home Address** or **Work Address** to edit.
4. Enter the new address and press the OK Key [SAVE] to save.

ADDING OR CHANGING COMPANY/TITLE/NOTES

To add or change information:

1. Press the Right Soft Key [Contacts], then select the Contact you want to edit.
2. Press the Left Soft Key [Edit].
3. Select **Company**, **Title**, or **Notes** to edit.
4. Enter the new text information and press the OK Key [SAVE] to save.

ADDING OR CHANGING BIRTHDAY

To add or change information:

1. Press the Right Soft Key [Contacts], then select the Contact you want to edit.
2. Press the Left Soft Key [Edit].
3. Select **Birthday** to edit.
4. Press the Left Soft Key [Set], then enter the desired month and date information.
5. Press the OK Key to save.

ADDING A SPEED DIAL ENTRY

To add a Speed Dial entry:

1. Press the Right Soft Key [Contacts], then select the Contact you want to add to Speed Dial.
2. Press the Left Soft Key [Edit].
3. Select the phone number you want to add to Speed Dial and press the Right Soft Key [Options].
4. Select **Set Speed Dial** and press the OK Key, choose a Speed Dial location then press the OK Key [SET].
5. To assign the entry select **Yes** then press the OK Key.
6. Press the OK Key [SAVE] to save.

ADDING OR CHANGING A IM SCREEN NAME

To add or change a IM screen name:

1. Press the Right Soft Key [Contacts], then select the Contact you want to edit.
2. Press the Left Soft Key [Edit].
3. Select **IM Screen Name**, then press the Left Soft Key [Set].

01

02

03

04

05

4. Select either **AIM, Yahoo!** or **WL Messenger** and press the OK Key.
5. Enter the user's Screen Name and press the OK Key to save.
6. Press the OK Key [**SAVE**] to save.

EDITING CONTACTS ENTRIES

ADDING A PHONE NUMBER FROM IDLE MODE

1. Enter the phone number you want to save (up to 32 digits).
2. Press the Left Soft Key [≡] [**Save**].
3. Select **Update Existing** and press the OK Key.
4. Select the contact to update and press the OK Key.
5. Select **Mobile 1, Mobile 2, Home, Business** or **Fax** and press the OK Key.
6. If a phone number is already assigned to the category you selected, select **Yes** to update and then press the OK Key.

ADDING A PHONE NUMBER FROM THE CONTACT LIST SCREEN

1. Press the Right Soft Key [≡] [**Contacts**]. Your **Contacts** display alphabetically.
2. Select the contact to update and press the Left Soft Key [≡] [**Edit**].
3. Enter the phone number in the appropriate field.
4. Press the OK Key [**SAVE**] to save.

DEFAULT NUMBERS

The phone number saved when a Contact is created is the Default Number. If more than one number is saved in a Contact entry, another number can be set as the Default Number.

 The Default Number can not be deleted. The entire Contact entry can be deleted or another number can be assigned as the Default Number allowing you to delete the original number and keep the Contact entry.

CHANGING THE DEFAULT NUMBER

1. Press the Right Soft Key [≡] [**Contacts**]. Your **Contacts** display alphabetically.
2. Select the contact to update and press the Left Soft Key [≡] [**Edit**].

3. Select the number to assign as the default number and press the Right Soft Key [≡] [**Options**].
4. Select **Set As Default** and press the OK Key.
5. Select **Yes** then press the OK Key to set as the default number.
6. Press the OK Key [**SAVE**] to save.

EDITING STORED PHONE NUMBERS

1. Press the Right Soft Key [≡] [**Contacts**]. Your **Contacts** display alphabetically.
2. Select the **Contact** entry you want to edit and press the Left Soft Key [≡] [**Edit**].
3. Select and edit the phone number as necessary and press the OK Key [**SAVE**].

DELETING

DELETING A PHONE NUMBER FROM A CONTACT

1. Press the Right Soft Key [≡] [**Contacts**]. Your **Contacts** display alphabetically.
2. Select the contact to update and press the Left Soft Key [≡] [**Edit**].
3. Select the number to delete.
4. Press and hold the CLR Key [CLR] to delete.
5. Press the OK Key [**SAVE**] to save.

DELETING A CONTACT ENTRY

1. Press the Right Soft Key [≡] [**Contacts**] and select the contact to delete.
2. Press the Right Soft Key [≡] [**Options**], select **Erase** and press the OK Key.
3. Select **Yes** and press the OK Key to erase.

DELETING A SPEED DIAL

1. Press the Right Soft Key [≡] [**Contacts**] and select the contact to edit.
2. Press the Left Soft Key [≡] [**Edit**].
3. Select the phone number which has speed dial and press the Right Soft Key [≡] [**Options**].

4. Select **Remove Speed Dial** and press the OK Key.
5. Select **Yes** and press the OK Key to erase.
6. Press the OK Key [**SAVE**] to save.

TEXT INPUT

The text entering mode (Alpha editor) allows you to input text, numbers and symbols. The default mode is [**Abc**] mode.

Key	Key Functions
	Abc : Press to change mode. [T9 Word][Abc][ABC][123][T9 Palabra][Symbols]
	Next : Press to view the next matching word in the predictive mode.
	Space : Press to select the word in predictive mode and/or add a space.
	Caps Lock : Press to select upper of lower letter case. Press and hold to change mode. [Abc] -> [123] -> [T9 Word] -> [T9 Palabra].
	Clear : Press to delete a character to the left of the cursor. Press and hold to delete an entire word.

USING THE TEXT INPUT MODE

There are six modes for entering text, numbers, symbols, and punctuation.

ABC (MULTI-TAP) TEXT INPUT MODE

Use the alphanumeric keypad to enter letters, numbers and characters.

Each of the following keys will scroll through these sequential options listed by language. The limitation is 160 characters. Press the key labeled with the target letter once for the first letter press twice for the second letter and so on. Press and hold the key labeled with the target number for that number.

Key	English	Spanish
	. @ ? ! - , & : ' / and 1	
	abc2	a á bc2
	def3	de é f3
	ghi4	gh i4
	jkl5	
	mno6	mn ñ o ó 6
	p q r s 7	
	t u v 8	
	w x y z 9	

By selecting the **ABC** mode, the text input only appears in capital letters.

PREDICTIVE MODE

T9 Word mode incorporates a built-in-dictionary to determine a word based on the entered characters. A word can be entered more quickly by pressing each key once per character. To type the word "Hello" follow these steps:

1. Press the Left Soft Key [**Message**], select **New Message** and press the OK Key.
2. Select **TXT Message** and press the OK Key.
3. Enter the phone number or email address in the "To" field and press the OK Key. In the **Text** field, press the Left Soft Key [**Abc**], and then **T9 Word** and press the OK Key.
4. Press to write "**Hello**". Press the Key to view the next word.
5. To select the word and add a space, press the Key.

NUMERIC MODE

Allows you to enter numbers.

1. From the text entry screen, press the Left Soft Key [≡] [Abc], select **123** and press the OK Key.
2. Press the corresponding keys to input the number.

USING PALABRA MODE TEXT INPUT

Palabra mode is a T9 mode for Spanish input.

To type the message "Llame la oficina," follow these steps from the text entry screen:

1. Press the Left Soft Key [≡], select **Palabra**, then press the OK Key.
2. Press [S I.JKL] / [S I.JKL] / [E ABC] / [G MNO] / [3 DEF].
3. Press [**#] to complete the word and add a space.
4. Press [S I.JKL] / [E ABC] / [**#] / [G MNO] / [3 DEF] / [4 GHI] / [E ABC] / [4 GHI] / [G MNO] / [E ABC] / [1 2*0] / [**#].
"Llame la oficina." is displayed.

SYMBOL MODE

Allows you to enter symbols.

1. From the text entry screen, press the Left Soft Key [≡] [Abc], select **Symbols** and press the OK Key.
2. Select the symbol you wish to enter by using the Directional Key [⊙]. Press the OK Key to select.

USING VOICE DICTATION MODE TEXT INPUT

By using the voice dictation function, you can input the text by speaking your words instead of using the keypad.

1. Press and hold the Voice Command Key [V], and speak into the handset.
2. When entered text is correct, press the OK Key to confirm. If incorrect, amend the text by using the keypad. For details on how to use keypad, see page 54, "TEXT INPUT"

- Voice dictation mode cannot be used when the Bluetooth® connection is in use.
- The voice dictation function supports US English only.

ONE, TWO, THREE DIGIT SPEED DIALING

Ideal for frequently dialed numbers, this feature allows contact entries to be dialed via the keypad with only one, two or three key presses.

ONE TOUCH SPEED DIALING:

If the speed dial is set to one digit number, press and hold the number you wish to connect to for more than 1 second.

TWO DIGIT SPEED DIALING:

If the speed dial is set to two digit numbers, press the first digit then press and hold the second digit of the number to dial.

THREE DIGIT SPEED DIALING:

If the speed dial is set to three digit numbers, press the first and second digits then press and hold the third digit of the number to dial.

01

02

03

04

05

MENU FUNCTION 4

This chapter addresses accessing the menu and using its functions and features to customize your C781.

- CONTACTS
- MESSAGING
- SETTINGS
- OPTIONS
- RECENT CALLS
- MEDIA CENTER
- VZ NAVIGATOR
- SETTINGS & TOOLS



C781

CONTACTS

NEW CONTACT

To add a new number to our contacts

For details on adding a new contact, see page 48.

CONTACT LIST

You can review all the entries stored in your Contact List or quickly find an entry by entering a name or its character.

1. Press the OK Key [MENU], select **Contacts** and press the OK Key.
2. Select Contact List then press the OK Key.
3. Enter a name in the Go To field or select the contact.
4. To edit the contact, press the Left Soft Key [Edit]. To view the details, press the OK Key [VIEW].

 Access the Contact List by pressing the Right Soft Key .

GROUPS

Allow you to classify phone entries into groups with up to 20 contacts in each group. The default groups - Personal and Business - cannot be erased or renamed.

TO ADD NEW GROUP

1. Press the OK Key [MENU], select **Contacts** and press the OK Key. Select **Groups** then press the OK Key.
2. Press the Left Soft Key [New].
3. Enter a new group name and press the OK Key [SAVE].

TO ASSIGN PHONE NUMBER TO GROUP

1. Press the OK Key [MENU], select **Contacts** and press the OK Key. Select **Groups** then press the OK Key.
2. Select the group to add the contact to and press the OK Key [VIEW].

3. To add a contact, press the OK Key [ADD]. Select the contact to add and press the OK Key [MARK] then press the Left Soft Key [Done] to add.

TO CHANGE GROUP NAME

1. Press the OK Key [MENU], select **Contacts** and press the OK Key. Select **Groups** then press the OK Key.
2. Select the group to rename, press the Right Soft Key [Options], select **Rename**, then press the OK Key.
3. Edit the group name and press the OK Key [SAVE].

ERASE GROUP

1. Press the OK Key [MENU], select **Contacts** and press the OK Key. Select **Groups** then press the OK Key.
2. Select the group to erase and press the Right Soft Key [Options]. Select **Erase Group** and press the OK Key.
3. Select **Yes** and press the OK Key to erase the group.

NEW PTT CONTACT

1. Enter the phone number you want to save.
2. Press the Right Soft Key [Options].
3. Select **Save To PTT Contact** and press the OK Key.
4. Enter the **Name**, **PTT Number**, and **PTT Group**.
5. Press the OK Key [SAVE].

 If the PTT Mode is disabled, the PTT menu options will not appear such as "New PTT Contact", "PTT Contact List" and "PTT Groups"

PTT CONTACT LIST

You can review all the entries stored in your PTT Contact List or quickly find an entry by entering a name or its character.

1. Press the OK Key [MENU], select **Contacts** and press the OK Key.

01

02

03

04

05

2. Select **PTT Contact List** then press the OK Key.
3. Enter a name in the Go To field or select the PTT contact.
PTT Contact information appears.

PTT GROUP

You can review all the entries stored in your PTT Group or quickly find an entry by entering a name or its character.

1. Press the OK Key [**MENU**], select **Contacts** and press the OK Key.
2. Select **PTT GROUP** then press the OK Key.
3. Enter a name in the Go To field or select the PTT group.
PTT Group information appears.

TEMP PTT GROUP

A Temp PTT Group allows you to quickly communicate with multiple contacts on a single PTT call. Temp PTT Groups can be created directly on your phone and are not permanently saved to your PTT Group list (unless you choose to save it). The following operation assigns a PTT Contacts to the Temp PTT Group.

ADDING PTT CONTACTS

1. In the idle mode, press the OK Key [**MENU**], select **Contacts**, then press the OK Key. Press **PTT Contact List**.
2. Press the Right Soft Key \mathbb{O} [**Options**], then press **Temp PTT Group**.
3. Press the OK Key [**ADD**], select a PTT Contact entry, press the OK Key [**MARK**], then Left Soft Key \mathbb{D} [**Done**].

VIEWING TEMP PTT GROUP MEMBERS

1. In the idle mode, press the OK Key [**MENU**], select **Contacts**, then press the OK Key. Press **PTT Contact List**.
2. Select the Right Soft Key \mathbb{O} [**Options**], then press **Temp PTT Group**.

3. Select the Temp PTT Group entry. You can select one of the following options:
 - Press the Left Soft Key \mathbb{D} [**Remove**] to remove the entry.
 - Press the Right Soft Key \mathbb{O} [**Options**] to select the desired options.

BACKUP ASSISTANT

Backup Assistant is a wireless service that saves a copy of your phone's address book to a secure web site. If your phone is lost, stolen or damaged, Backup Assistant restores your saved address book to a new phone - wirelessly! Schedule daily automatic backups or manually backup your phone book at your convenience. Login to your web account and get full access to your address book. You can view, print, add, delete and edit contacts. Changes are sent to your phone with one click!

Visit Web site: <https://www.verizonwireless.com/backupassistant/>.

1. Press the OK Key [**MENU**], select **Contacts** and press the OK Key.
2. Select **Backup Assistant** and press the OK Key to launch the application.

SPEED DIALS

Calls can be placed to numbers stored in speed dial by pressing & holding the location number on the keypad. For a 2-digit location number, press the first number then press and hold the second number. For a 3-digit location number, press the first number and second numbers then press and hold the third number.

1. Press the OK Key [**MENU**], select **Contacts** and press the OK Key. Select **Speed Dials** then press the OK Key.
2. Select the **Speed Dial** position or enter the **Speed Dial** digit and press the OK Key [**SET**].
3. Select the **Contact** and press the OK Key.
4. Select the number to assign the speed dial to and press the OK Key.
5. Select **Yes** and press the OK Key.

 Unassigned appears if the location is available.

TO ERASE A SAVED SPEED DIAL

1. Press the OK Key [MENU], select **Contacts** and press the OK Key. Select **Speed Dials** then press the OK Key.
2. Select the **Speed Dial** entry to erase.
3. Press the Right Soft Key \mathbb{R} [Remove].
4. Select **Yes** and press the OK Key.

IN CASE OF EMERGENCY

Your phone has a special menu to organize your emergency contacts and personal information.

TO ASSIGN EMERGENCY CONTACTS

Follow the procedures below to register a Contact to be contacted in case of emergency or to register a medical record number or other personal information.

1. Press the OK Key [MENU], select **Contacts** and press the OK Key. Select **In Case of Emergency** then press the OK Key.
2. Select **Contact 1**, **Contact 2** or **Contact 3** and press the OK Key [ADD].
3. When selecting from **Add Contact**, select **From Contacts** and press the OK Key.
4. Select the desired contact entry and press the OK Key.
5. When adding a new contact, select **New Contact** and press the OK Key.
6. Enter the contact information and press the OK Key [SAVE].
7. The contact name will be displayed in place of **Contact 1**, **Contact 2** or **Contact 3**.

TO RE-ASSIGN EMERGENCY CONTACTS

1. Press the OK Key [MENU], select **Contacts** and press the OK Key. Select **In Case of Emergency** then press the OK Key.
2. Select the contact to re-assign and press the Right Soft Key \mathbb{R} [Options].
3. Select **Re-assign** and press the OK Key.

4. Select **From Contacts** and press the OK Key. Select a contact from your **Contact List**. When adding a new contact, select **New Contact** and press the OK Key.
5. Press the OK Key.

TO ERASE ASSIGNED EMERGENCY CONTACTS

1. Press the OK Key [MENU], select **Contacts** and press the OK Key. Select **In Case of Emergency** then press the OK Key.
2. Select the contact to erase and press the Right Soft Key \mathbb{R} [Options].
3. Select **Unassign** and press the OK Key.

TO CALL AN ASSIGNED EMERGENCY CONTACT

1. Press the OK Key [MENU], select **Contacts** and press the OK Key. Select **In Case of Emergency** then press the OK Key.
2. Select the contact to call and press the Left Soft Key \mathbb{L} [Call] or press the SEND Key \mathbb{C} .

TO ADD PERSONAL INFO

To store a Medical Record Number or other information that may be useful in case of an emergency:

1. Press the OK Key [MENU], select **Contacts** and press the OK Key. Select **In Case of Emergency** then press the OK Key.
2. Select **Personal Info** and press the OK Key [VIEW].
3. Select **Note 1**, **Note 2** or **Note 3** and press the OK Key [ADD].
4. Enter the information and press the OK Key [SAVE].
5. The information you entered now appears in place of **Note 1**, **Note 2** or **Note 3**.

TO EDIT SAVED PERSONAL INFO

1. Press the OK Key [MENU], select **Contacts** and press the OK Key. Select **In Case of Emergency** then press the OK Key.

2. Select **Personal Info** and press the OK Key [VIEW].
3. Select the note to edit and press the OK Key [VIEW].
4. Press the OK Key [EDIT]. Edit the note and press the OK Key [SAVE].

TO ERASE SAVED PERSONAL INFO

1. Press the OK Key [MENU], select **Contacts** and press the OK Key. Select **In Case of Emergency** then press the OK Key.
2. Select **Personal Info** and press the OK Key [VIEW].
3. Select the note to erase and press the Right Soft Key  [Erase].
4. Select **Yes** and press the OK Key.

MY NAME CARD

A Name Card with the handset's mobile number automatically appears.

EDIT MY NAME CARD

1. Press the OK Key [MENU], select **Contacts** and press the OK Key. Select **My Name Card** then press the OK Key.
2. Press the Left Soft Key  [Edit].
3. Edit the **My Name Card** options and press the OK Key [SAVE] to save your changes.

SEND MY NAME CARD VIA TEXT OR PICTURE MESSAGE

1. Press the OK Key [MENU], select **Contacts** and press the OK Key. Select **My Name Card** then press the OK Key.
2. Press the Right Soft Key  [Send].
3. Select the message type and press the OK key.
4. Enter the recipient's contact information and press the OK Key.
5. Enter any additional message information and press the OK Key [SEND].

SEND MY NAME CARD WITH VOICE MESSAGE

1. Press the OK Key [MENU], select **Contacts** and press the OK Key. Select **My Name Card** then press the OK Key.
2. Press the Right Soft Key  [Send].
3. Select **Via Voice Message** and press the OK Key.
4. To record a new **voice message**, press the OK Key to start recording. Press the OK Key [STOP] to stop recording and save it.
5. Enter the recipient's contact information in the To field and press the OK Key.
6. Enter any additional message information and press the OK Key [SEND].

SEND MY NAME CARD TO ANOTHER BLUETOOTH DEVICE

 Turn on Bluetooth on both devices (steps 1-4) and turn Discovery Mode to On. Please refer to Bluetooth on page 101.

1. Press the OK Key [MENU], select **Contacts** and press the OK Key. Select **My Name Card** then press the OK Key.
2. Press the Right Soft Key  [Send].
3. Select **Via Bluetooth** and press the OK Key.
4. With **Add New Device** selected, press the OK Key. The handset will prompt you with the following message on the LCD screen: **PLACE DEVICE YOU ARE CONNECTING TO IN DISCOVERABLE MODE.** Press the OK Key.
5. Select the desired device and press the OK Key [PAIR].
6. If applicable, the device may prompt you for the Passkey. Consult the Bluetooth® accessory (sold separately) instructions for the appropriate password (typically 0000 - 4 zeroes). Enter the passkey and press the OK Key.
7. The screen displays **Before Connecting To [Device Name]**, select either **Always Ask** or **Always Connect** and press the OK Key.
8. The information is then sent via Bluetooth to the receiving device.

01

02

03

04

05

MESSAGING

WHEN A NEW MESSAGE ARRIVES

1. The received message display appears when a new message arrives.
2. To display the message, select **View Now** and press the OK Key.

NEW MESSAGE

TXT MESSAGE

Verizon Wireless voice coverage is available in multiple destinations worldwide, so you'll use one number wherever you travel. Plus, stay connected to email, text and picture messaging, web, and wireless networks while you're on the go in multiple data destinations around the world. Visit vzw.com/vzglobal for details.

- The SIM card must be installed in order to send Text Messages in GSM mode.
- The SIM Card is pre-installed in your phone.

1. Press the Left Soft Key [Message], select **New Message**. Select **TXT Message** and press the OK Key.

The Left Soft Key [Message] is not available when **PTT Mode** is set to **On**.

2. Enter the phone number and press the OK Key. Or press the Right Soft Key [Add] to access the following options.
 - **From Contacts**: Search for a phone number which is stored in the contacts list.
 - **Recent Calls**: Search for a phone number which is stored in the recent calls list.
 - **Groups**: Search the groups stored in the contacts list.
 - **To Contacts**: Save the number or email you've just entered to the contacts list.
 - **To PTT Contacts**: Save the number or email you've entered to the PTT contact list.
3. Press the Right Soft Key [Options] to access the following options.
 - **Insert Quick Text**: Inserts already written sentences in TXT message.
 - **Save As Draft**: Save the TXT message.
 - **Add**: Attach **Graphic**, **Animation**, **Sound**, **Name Card**, or **Address From Contacts**.
 - **Format Text**: Edit the **Alignment**, **Font Size**, **Font Style**, **Font Color** and **Background Color**.
 - **Priority Level**: Set the level of the priority to **High** or **Normal**.
 - **Cancel Message**: Cancel message.

4. Enter the message and press the OK Key [SEND].

As long as one field is complete in the TXT Message, the message will be saved in the Sent box.

PICTURE MESSAGE

- The SIM card must be installed in order to send Picture Messages in GSM mode.
- The SIM Card is pre-installed in your phone.

1. Press the Left Soft Key [Message], select **New Message** and press the OK Key. Select **Picture Message** and press the OK Key.
2. Enter the phone number and press the OK Key. Or press the Right Soft Key [Add] to access the following options.
 - **From Contacts**: Search for a phone number which is stored in the contacts list.
 - **Recent Calls**: Search for a phone number which is stored in the recent calls list.
 - **Groups**: Search the groups stored in the contacts list.
 - **To Online Album**: Send picture message by using online address.
 - **To Contacts**: Save the number or email you've entered to the contacts list.
 - **To PTT Contacts**: Save the number or email you've just entered to the PTT contacts list.
3. Enter the message in the Text field.
4. Select **Picture** and press the Left Soft Key [My Pics]. Select the desired picture and press the OK Key to select. You can only send one picture file at a time.
5. Select **Sound** and press the Left Soft Key [Sounds]. Select the desired sound and press the OK Key to select. You can only send one sound file at a time.
6. Select **Name Card**. Press the Left Soft Key [Add] and select **My Name Card** or **From Contacts** and press the OK Key. Select the card or the contact and press the OK Key.
7. Select **Subject** and write the subject.

01

02

03

04

05

8. Press the Right Soft Key \mathbb{K} [**Options**] to access the following options.

- **Preview:** Preview a written Picture Message.
- **Save As Draft:** Save the Picture Message.
- **Insert Quick Text:** Inserts already written sentences in Picture Message.
- **Add Slide:** Add another message.
- **Priority Level:** Set the level of the priority to High or Normal.
- **Save As Quick Text:** Save as a text message.
- **Cancel Message:** Cancel message.

9. Press the OK Key [SEND].

VIDEO MESSAGE

-  • The SIM card must be installed in order to send Picture Messages in GSM mode.
- The SIM Card is pre-installed in your phone.

1. Press the Left Soft Key \mathbb{K} [**Message**], select New Message and press the OK key. Select Video Message and press the OK Key.
2. Enter the phone number and press the OK Key. Or press the Right Soft Key \mathbb{K} [**Add**] to access the following options.
 - **From Contacts:** Search for a phone number which is stored in the contacts list.
 - **Recent Calls:** Search for a phone number which is stored in the recent calls list.
 - **Groups:** Search the groups stored in the contacts list.
 - **To Online Album:** Send picture message by using online address.
 - **To Contacts:** Save the number or email you've entered to the contacts list.
 - **To PTT Contacts:** Save the number or email you've just entered to the PTT contacts list.
3. Enter the message in the Text field.
4. Select Video and press the Left Soft Key \mathbb{K} [**Videos**]. Select the desired video and press the OK Key to select. You can only send one video file at a time.
5. Select **Name Card**. Press the Left Soft Key \mathbb{K} [**Add**] and select **My Name Card** or **From Contacts** and press the OK Key. Select the card or the contact and press the OK Key.
6. Select **Subject** and write the subject.

7. Press the Right Soft Key \mathbb{K} [**Options**] to access the following options.

- **Preview:** Preview a written Picture Message.
- **Save As Draft:** Save the Picture Message.
- **Insert Quick Text:** Inserts already written sentences in Picture Message.
- **Add Slide:** Add another message.
- **Priority Level:** Set the level of the priority to High or Normal.
- **Save As Quick Text:** Save as a text message.
- **Cancel Message:** Cancel message.

8. Press the OK Key [SEND].

VOICE MESSAGE

1. Press the Left Soft Key \mathbb{K} [**Message**], select **New Message** and press the OK Key. Select **Voice Message** and press the OK Key.
2. To record a new **Voice Message**, press the OK Key to start recording. Press the OK Key [STOP] to stop recording and save it.
3. Enter the phone number and press the OK Key. Or press the Right Soft Key \mathbb{K} [**Add**] to access the following options.
 - **From Contacts:** Search for a phone number which is stored in the contacts list.
 - **Recent Calls:** Search for a phone number which is stored in the recent calls list.
 - **Groups:** Search the groups stored in the contacts list.
 - **Send to Online Album:** Send the recorded voice message to the Online Album.
 - **To Contacts:** Save the number or email you've entered to the contacts list.
 - **To PTT Contacts:** Save the number or email you've just entered to the PTT contacts list.
4. From the **Voice** field, you can re-record the message by pressing the Left Soft Key \mathbb{K} [**Record**]. You can only send one voice file at a time.
5. Select **Text** and enter the message.
6. Select the **Name Card**. Press the Left Soft Key \mathbb{K} [**Add**] and select **My Name Card** or **From Contacts** and press the OK Key. Select the card or the contact and press the OK Key.
7. Select **Subject** and write the subject.

8. Press the Right Soft Key \mathbb{O} [Options] to access the following options.

- **Review:** Review a written Voice Message.
- **Save As Draft:** Save the Voice Message.
- **Insert Quick Text:** Inserts already written sentences in Picture Message.
- **Priority Level:** Set the level of the priority to **High** or **Normal**.
- **Save As Quick Text:** Save as a text message.
- **Cancel Message:** Cancel message.

9. Press the OK Key [SEND].

INBOX

The Inbox manages received messages. To access:

1. Press the Left Soft Key \mathbb{M} [Message], select **Inbox** and press the OK Key.
2. Select a message and press the OK Key [OPEN]. To delete a message, press the Left Soft Key \mathbb{E} [Erase] and press the OK Key to select **Yes**. With the message opened, press the Right Soft Key \mathbb{O} [Options] to access the following options.
 - **Play Again:** Play a received picture, video, or voice message.
 - **Erase:** Erase an inbox message.
 - **Reply w. Copy:** Reply with the original message included.
 - **Forward:** Forward the TXT, Picture or Voice message.
 - **Save Picture (MMS Picture):** Save a picture to the **My Pictures** folder.
 - **Save Video (MMS Video):** Save a video to the **My videos** folder.
 - **Save As Ringtone (MMS Sound):** Save a sound to the **My Ringtones** folder.
 - **Save Sound (MMS Sound):** Save a sound to the **My Sounds** folder.
 - **Save Objects (EMS Save Objects):** Save a graphic, sound, name card.
 - **Save Name Card:** Save a name card to the contacts.
 - **Save As Quick Text:** Save received text msg to **Quick Text**.
 - **Lock/Unlock:** Locks or unlock the TXT, Picture or Voice message.
 - **Add To Contacts:** Save a number to contacts.
 - **Extract Addresses:** Extract all phone numbers, Email addresses and URLs from the received message.
 - **Text Speech:** Read out the text message.
 - **Message Info:** Show received TXT, Picture or Voice message information.

SENT

Manages **TXT**, **Picture**, **Video**, and **Voice** messages already sent or waiting to be sent.

1. Press the Left Soft Key \mathbb{M} [Message], select **Sent** and press the OK Key.
2. Select a message and press the OK Key [OPEN]. To delete a message, press the Left Soft Key \mathbb{E} [Erase] and press the OK Key to select **Yes**.
3. With the message opened, press the Right Soft Key \mathbb{O} [Options] to access the following options.
 - **Play Again:** Play a received Picture or Voice message.
 - **Forward:** Forward the TXT, Picture, Video, and Voice message.
 - **Erase:** Erase a sent message.
 - **Lock:** Locks or unlock the TXT, Picture, Video, and Voice message.
 - **Save as Quick Text:** Save sent text message to quick text.
 - **Add To Contacts:** Save number to contacts.
 - **View Name Card:** View included name card with in message.
 - **Message Info:** Show sent TXT, Picture, Video, and Voice message information.

DRAFTS

The Drafts folder contains any draft messages or saved messages. If a message was interrupted by a voice call or other interrupting event, the message will automatically be saved here.

1. Press the Left Soft Key \mathbb{M} [Message], select **Drafts** and press the OK Key.
2. Select a message to edit and press the OK Key [EDIT].
Edit the message.
3. To delete a message, press the Left Soft Key \mathbb{E} [Erase] and press the OK Key to select **Yes**.
4. Press the Right Soft Key \mathbb{O} [Options] to access the following options.
 - **Send:** Send a selected message.
 - **Lock:** Locks or unlock the TXT, Picture, Video, or Voice message.
 - **Add To Contacts:** Save number to contacts.
 - **Erase Drafts:** Erase all drafts messages.

VOICEMAIL

New voicemail alerts are sent by your network. These messages indicate how many new and urgent voicemails are in your voicemail box.

WHEN A NEW VOICEMAIL ARRIVES

When you receive a new voicemail message you'll hear a sound and a Voicemail icon appears in the display.

1. Select **Listen Now** and press the OK Key to access your voicemail box.
2. Select **Listen Later** and press the OK Key to ignore the voicemail message and return to idle mode.

TO ACCESS YOUR VOICE MAILBOX

1. To dial your voicemail box directly, press **[*+37]**, **[8 777]**, **[6 300]** and then press the SEND Key **[#]**. Press the Left Soft Key **[≡]** **[Message]**, select **Voicemail** and press the OK Key then press the OK Key **[CALL]** to dial.

 **Shortcut:** In idle mode, press and hold **[1 2 3 6]** to access **Voicemail**. **One Touch Dial** must be enabled, please see page 57 for details.

2. Follow the prompts to enter your password and listen your messages.

MOBILE IM

LAUNCHING MOBILE IM

1. Press the Left Soft Key **[≡]** **[Message]**, select **Mobile IM** and press the OK Key.
2. When you access this application for the first time, an **Accept/Dedline** screen will appear. Select **Accept** and press the Left Soft Key **[≡]** **[Accept]**. Or press the OK Key.
3. Select either **AIM**, **WL Messenger** or **Yahoo!** and press the OK Key.
4. Enter your **Login ID** and **Password** and press the OK Key **[Sign In]**.

MOBILE EMAIL

USING MOBILE EMAIL

To read and send e-mail from your e-mail accounts:

1. From idle mode, press the OK Key **[MENU]**, select **Messaging**, then press the OK Key.
2. Select **Mobile Email** and then press the OK Key.
3. Select the desired option, then press the OK Key.
4. To send an e-mail, follow the on-screen prompts.

SETTINGS

The **Settings** menu allows you to configure settings for messages sent or received on your phone. To access message settings:

1. Press the OK key **[MENU]**, then press **Messaging**.
2. Press the Left Soft Key **[≡]** **[Settings]** to display available menus.
3. Select one of the following menus, then press the OK Key.

MESSAGES VIEW

1. Select **By Time** or **By Contact**, then press the OK Key.
 - **By Time:** Sorts received and sent messages into Inbox and Sent folders by time.
 - **By Contact:** Groups all received and sent messages by each contact.

ENTRY MODE

Allows you to set the default Entry Mode for messaging.

1. Select **T9 word, Abc, ABC, 123**, or **T9 Palabra** then press the OK Key.

AUTO SAVE SENT

1. Select **On, Off**, or **Prompt**, then press the OK Key.
 - **On:** All sent messages are saved in Sent.
 - **Off:** All sent messages are not saved in Sent.
 - **Prompt:** The **Yes** or **No** dialogue box will be displayed after sending a message.

01

02

03

04

05

AUTO ERASE INBOX

Allows you to set whether Inbox messages are deleted automatically when new messages arrive and Inbox is full.

1. Select **On** or **Off**, then press the OK Key.
 - **On**: The oldest message will be deleted from the Inbox automatically once full.
 - **Off**: The oldest message will not be deleted automatically from the Inbox once full.

MESSAGING FONT SIZE

Allows you to set the message font size.

1. Select **Small**, **Normal**, or **Large**, then press the OK Key.

TXT AUTO VIEW

1. Select **On** or **Off**, then press the OK Key.
 - **On**: TXT messages are displayed automatically when received.
 - **Off**: TXT messages are displayed by going into the Inbox, or by responding to the message prompt.

MULTIMEDIA AUTO RECEIVE

1. Select **On** or **Off**, then press the OK Key.
 - **On**: Picture, Video and Voice messages are downloaded automatically.
 - **Off**: Picture, Video and Voice messages must be retrieved from the Inbox or by responding to the message prompt.

TUTORIAL

Introduces the user to the basic concepts and features of the phone functions.

1. Select the desired option.
2. Press the OK key to view the tutorial.

QUICK TEXT

Allows you to create a new Quick Text or edit the predefined Quick Text.

1. To create a new Quick Text, press the Right Soft key [**Options**], then press **New**. Enter the new text and press the OK Key [**SAVE**].

2. To edit the predefined Quick Text, select the Quick Text from the list, then press the OK Key [**EDIT**].
3. To change the Quick Text position, press the Right Soft Key [**Options**], then press **Move**. Press the Directional Key up or down to scroll to desired position, then press the OK key [**SAVE**].
4. To erase a saved Quick Text, press the Left Soft Key [**Erase**]. Select **Yes** and press the OK key.

VOICEMAIL #

1. Enter a new voicemail number or edit the voicemail number then press the OK key.
2. Press the Left Soft Key [≡] [**Add**], then press **Wait** or **2 Sec Pause**.

CALLBACK #

Allows you to use or edit the default callback number so that the recipient can callback or reply.

1. Select **On** or **Off**, then press the OK key.
2. If **On** is selected, enter a new callback number then press the OK key.

SIGNATURE

Allows you to create a signature that can be automatically inserted at the end of each message.

1. To deactivate Signature function, select **None** and press the OK Key.
2. To insert a Signature, select **Custom**, enter your signature in the text entry field then press the OK key.

DELIVERY RECEIPT

Allows you to set delivery receipts for sent messages.

1. Select **On** or **Off**, then press the OK Key.
 - **On**: Request to receive the delivery acknowledgement.
 - **Off**: Do not request to receive the delivery acknowledgement.

01

02

03

04

05

OPTIONS

To erase all messages stored in your Message or Drafts folders:

1. From idle mode, press the OK Key [MENU], select Messaging, then press the OK Key.
2. Press the Right Soft Key  [Options] to access the following options:
 - **Erase Inbox:** Erase messages in the Inbox folder.
 - **Erase Sent:** Erase messages in the Sent folder.
 - **Erase Drafts:** Erase messages in the Drafts folder.
 - **Erase All:** Erase all the stored messages.

RECENT CALLS

The Recent Calls menu is a list of the last phone numbers or Contact entries for calls you placed, accepted, missed or blocked. It is continually updated as new numbers are added to the beginning of the list and the oldest entries are removed from the bottom of the list.

MISSED

Displays information about the 90 most recently missed calls.

1. Press the OK Key [MENU], select **Recent Calls** and press the OK Key. Select **Missed** and press the OK Key.
2. Select an entry and press the OK Key [OPEN] to view the entry.
3. Press the Right Soft Key  [Options] to access the following options:
 - **Save to Contacts:** Store the phone number in your **Contacts**.
 - **Save to PTT Contacts:** Store the phone number in your PTT Contacts.

 If save doesn't appear, that entry is already in your Contacts list.

- **Details:** Displays details about the caller if entered in **Contacts**.
 - **Erase:** Erase a call listing.
 - **Lock/Unlock:** To lock or unlock a call listing.
 - **Erase All:** Erase all the call listing.
 - **View Timers:** Display usage time.
4. Press the Left Soft Key  [Message] to access the following options.
 - **TXT Message:** Send a TXT message to the contact.

- **Picture Message:** Send a Picture message to the contact.
- **Video Message:** Send a Video message to the contact.
- **Voice Message:** Send a Voice message to the contact.

RECEIVED

Displays information about the 90 most recently received calls.

1. Press the OK Key [MENU], select **Recent Calls** and press the OK Key. Select **Received** and press the OK Key.
2. Select an entry and press the OK Key [OPEN] to view the entry.
3. Press the Right Soft Key  [Options] to access the following options:
 - **Save to Contacts:** Store the phone number in your **Contacts**.
 - **Save to PTT Contacts:** Store the phone number in your PTT Contacts.

 If save doesn't appear, that entry is already in your Contacts list.

- **Details:** Displays details about the caller if entered in **Contacts**.
 - **Erase:** Erase a call listing.
 - **Lock/Unlock:** To lock or unlock a call listing.
 - **Erase All:** Erase all the call listing.
 - **View Timers:** Display usage time.
4. Press the Left Soft Key  [Message] to access the following options.
 - **TXT Message:** Send a TXT message to the contact.
 - **Picture Message:** Send a Picture message to the contact.
 - **Video Message:** Send a Video message to the contact.
 - **Voice Message:** Send a Voice message to the contact.

 After 90 received calls, the oldest call will automatically be erased from the history.

DIALED

Displays information about the 90 most recently dialed numbers.

1. Press the OK Key [MENU], select **Recent Calls** and press the OK Key. Select **Dialed** and press the OK Key.
2. Select an entry and press the OK Key [OPEN] to view the entry.

01

02

03

04

05

3. Press the Right Soft Key  [**Options**] to access the following options:
 - **Save to Contacts**: Store the phone number in your [Contacts](#).
 - **Save to PTT Contacts**: Store the phone number in your PTT Contacts.



 If save doesn't appear, that entry is already in your Contacts list.

- **Details**: Displays details about the caller if entered in [Contacts](#).
 - **Erase**: Erase a call listing.
 - **Lock/Unlock**: To lock or unlock a call listing.
 - **Erase All**: Erase all the call listing.
 - **View Timers**: Display usage time.
4. Press the Left Soft Key  [**Message**] to access the following options.
 - **TXT Message**: Send a TXT message to the contact.
 - **Picture Message**: Send a Picture message to the contact.
 - **Video Message**: Send a Video message to the contact.
 - **Voice Message**: Send a Voice message to the contact.

4. Press the Left Soft Key  [**Message**] to access the following options.
 - **TXT Message**: Send a TXT message to the contact.
 - **Picture Message**: Send a Picture message to the contact.
 - **Video Message**: Send a Video message to the contact.
 - **Voice Message**: Send a Voice message to the contact.

VIEW TIMERS

Timers allow you to check your usage time and manage your calls.

1. Press the OK Key [**MENU**], select **Recent Calls** and press the OK Key. Select **View Timers** and press the OK Key.
2. Select **Last Call, All Calls, Received Calls, Dialed Calls, Roaming Calls, Transmit Data, Received Data, Total Data, Last Reset, Lifetime Calls** and **Lifetime Data Counter** to view the information.
3. Press the Left Soft Key  [**Reset**] to reset the highlighted timer.
4. Press the Right Soft Key  [**Reset All**] to reset all timers.

ALL

Displays information about the most recently received, dialed and missed calls.

1. Press the OK Key [**MENU**], select **Recent Calls** and press the OK Key. Select **All** and press the OK Key.
2. Select an entry and press the OK Key [**OPEN**] to view the entry.
3. Press the Right Soft Key  [**Options**] to access the following options:
 - **Save to Contacts**: Store the phone number in your [Contacts](#).
 - **Save to PTT Contacts**: Store the phone number in your PTT Contacts.

 If save doesn't appear, that entry is already in your Contacts list.

- **Details**: Displays details about the caller if entered in [Contacts](#).
- **Erase**: Erase a call listing.
- **Lock/Unlock**: To lock or unlock a call listing.
- **Erase All**: Erase all the call listing.
- **View Timers**: Display usage time.

MEDIA CENTER

Your phone provides a unique feature - Media Center - that enables you to download ringtones, wallpapers, games and more from your network to your phone. Please contact your service provider for the availability of these services.

APPS

To download tools that can help you navigate to entertainment sports, restaurants, and provide you with up-to-date weather information:

1. In the idle mode, press the OK Key [**MENU**], then press **Media Center**.
2. Select **App** then, press **SHOP APPS**.
3. Press the OK Key to launch the application.

MOBILE WEB

Find the news you want or let it come to you. Now, a few seconds is all it takes to get up-to-the-minute information.

STARTING THE MOBILE WEB

1. From idle mode, press the OK key [MENU], select Media Center, and press the OK key.
2. Select the Mobile Web and press the OK key.
The browser launches.

EXIT

Press the END/PWR Key [⏻] to exit out of the browser and return to idle mode.

TUNES & TONES

USING MY RINGTONES

1. Press the OK Key [MENU], select **Media Center** and press OK Key.
Select **Tunes & Tones** and press the OK Key.
2. Select **My Ringtones** and press the OK Key.
3. Select the desired sound and press the OK Key [Play] to play.
4. Press the OK Key [STOP] to stop playing. Press the LEFT Soft Key [≡] [Set As] to access the following options:
 - **Ringtone:** Set as ringtone
 - **Contact ID:** Set as contact ID
 - **Alert Sounds:** Set as alert sound

USING MY SOUNDS

1. Press the OK Key [MENU], select **Media Center** and press OK Key.
Select **Tunes & Tones** and press the OK Key.
2. Select **My Sounds** and press the OK Key.

3. Select **Record New** to start your own recording or select the desired sound and press the OK Key [Play] to play.
4. Press the OK Key [STOP] to stop playing.
Press the LEFT Soft Key [≡] [Set As] to access the following options:
 - **Ringtone:** Set as ringtone
 - **Contact ID:** Set as contact ID
 - **Alert Sounds:** Set as alert sound
5. Press the RIGHT Soft Key [≡] [Options] to access the following options:
 - **Downloaded** or **Recorded sound:**
 - **Send:** Send the sound.
 - **Send Via Email:** Send the sound via email
 - **To Online Album:** Upload the selected sound to Online Album.
 - **Rename:** Rename the sound's title.
 - **Move:** Move the sound to the memory card.
 - **Erase:** Erase the selected sound.
 - **Erase All:** Erase all the sounds.
 - **File Info:** Displays information for the selected sound.
 - **Preloaded sound:**
 - **Send:** Send a sound.
 - **To Online Album:** Upload the selected sound to Online Album.
 - **File Info:** Displays information for the selected sound.

PICTURE & VIDEO

USING V CAST VIDEOS

By accessing to **V CAST Videos**, you can watch your favorite television shows while on the go. Please contact your service provider for the availability of service.

USING MY PICTURES

In My Pictures you can view all the pictures you have taken, store selected images in your phone, send pictures to the Online Album, delete images and access additional picture options.

1. Press the OK Key [MENU], select **Media Center**.

2. Select **Picture & Video** and press the OK Key.
3. Select the desired image. Press the Right Soft Key [**Options**] to access the following options.
 - **Send**: Send a picture message, or upload to online album.
 - **Set As**: Assigns the selected picture to display for specific tasks.
 - **Take Picture**: Take a new picture.
 - **Manage Pictures**: Manage the pictures.
 - **Rename**: Rename the selected picture.
 - **File Info**: Displays information about the selected picture.

To erase the picture:

1. Press the OK Key [**MENU**], select **Media Center**.
2. Select **Picture & Video** and press the OK Key.
3. Select the desired image. Press the Left Soft Key [**Erase**] to access erase.

USING MY VIDEOS

In My Videos you can play the videos you have taken by using your phone, send videos to the Online Album, or set video as wallpaper in your phone.

1. Press the OK Key [**MENU**], select **Media Center**.
2. Select **Picture & Video** and press the OK Key.
3. Select the desired video. Press the Right Soft Key [**Options**] to access the following options.
 - **Send**: Send a **Video Message** or upload **To Online Album**. You can select **Via Bluetooth** or **Via Email**.
 - **Record Video**: Record a new video
 - **V CAST Videos**: Connect to the V CAST Video service.
 - **Set As Wallpaper**: Assigns the selected video as wallpaper
 - **Manage Videos**: Manage the video.
 - **Rename**: Displays information about the selected video.
 - **File Info**: Displays information about the selected video.

TAKING PICTURES

1. To access the camera, with the flip open, press the Camera Key [CAM].
2. Focus the object.
3. Press the Directional Key [DIRECTIONAL] left or right to zoom in or out. (Except for the 2048X1536 resolution mode).
4. Press the Right Soft Key [**Options**] to access the following options.

Name	Description
Auto Focus	OFF, ON
Resolution	2048X1536, 1600X1200, 1280X960, 640X480, 320X240, 160X120
Self Timer	Off, 3 Seconds, 5 Seconds, 10 Seconds
Flash	Off, On, Only This Shot
Brightness	-5, -4, -3, -2, -1, 0, +1, +2, +3, +4, +5
White Balance	Auto, Sunny, Cloudy, Tungsten, Fluorescent,
Shutter Sound	Shutter, Silent
Color Effects	Normal, Black & White, Negative, Sepia, Green, Aqua,
Multishot	OFF, ON
Night Mode	OFF, ON
Viewfinder	Main Display, Front Display
Memory	Phone, Card



5. Press the OK Key [**TAKE**] to take the picture.
6. To save the picture, press the Left Soft Key [SAVE] [**Save**]. To take another picture without saving, press the Right Soft Key [ERASE] [**Erase**]. To send as a Picture Message, press the OK Key [**SEND**].

RECORDING VIDEO

1. To access the video camera, with the flip open, press the Camera Key [CAM].
2. Press the Camera Key [CAM] once again to use the video recording mode.
3. Focus the object.

- Press the Directional Key  left or right to zoom in or out.
- Press the Right Soft Key **[Options]** to access the following options.

Name	Description
Recording Light	Off, On, Only This Shot
Brightness	-5, -4, -3, -2, -1, 0, +1, +2, +3, +4, +5
White Balance	Auto, Sunny, Cloudy, Tungsten, Fluorescent
Shutter Sound	On, Off
Recording Time	60 seconds for Video MSG, 60 Minutes for Save
Call Interruption	Allow, Block
Viewfinder	Main Display, Front Display
Memory	Phone, Card

- Press the OK Key **[REC]** to record a video.
- To save the videos, press the Left Soft Key  **[Save]**. To take another video without saving, press the Right Soft Key  **[Erase]**. To send as a Video Message, press the OK Key **[SEND]**.

VZ NAVIGATOR

VZ Navigator — Now you can find the address of a great restaurant or the nearest ATM.

Check movie times. Discover the latest hot spots. And know exactly how to get where you're going.

VZ Navigator puts all the advanced features of the latest GPS devices and systems on your wireless device — at a fraction of the price.

VZ Navigator provides:

- Heads-up, voice-prompted, turn-by-turn directions with auto-rerouting if you miss a turn
- Local search of nearly 14 million points of interest in the U.S.

- Detailed color maps that can be quickly panned and zoomed With VZ Navigator, you'll know exactly where you are, what's around you and how to get there. Download, subscription, and airtime required for use; only in National Enhanced Services Coverage Area; accuracy and completeness of information is not guaranteed; information about location of device will be used to deliver service.

- Press the OK Key **[MENU]**, select **VZ Navigator**.
- Press the OK Key.

 To use VZ Navigator, your phone's location capability must first be enabled. To turn Location On, see details on page 116.

 Changing VZ Navigator setting does not automatically enable retrieval of the location of the phone, you must still grant VZ Navigator access to the location capability before it can acquire the phone's location. The first time you run VZ Navigator, you will be prompted to grant this permission to the application.

SETTINGS & TOOLS

MY VERIZON

To access your Verizon account information:



- Press the OK Key **[MENU]**, select **Settings & Tools** and press the OK Key.
- Select **My Verizon** and press the OK Key.

 **Shortcut:** In idle mode, press the Directional Key  left to access My Verizon.

- Select access the following options.
 - **Balance:** Information about your balance.
 - **Usage:** Information about your usage.
 - **Payments:** Information about your payments.
 - **My Plan:** Information about your plan.
 - **My Features:** Information about your service features.
 - **Chg Vmail Pswd:** Resetting about your voicemail password.
 - **Find Store:** Information about stores near you.
 - **Mobile2Mobile:** Information about gift card options.

- **FAQs:** Frequently asked questions.

MASTER VOLUME

1. Press the Volume Keys  to adjust the master volume level.
 - To check the ringtone's volume, press the Left Soft Key  [Play].
2. Press the OK Key [SET] to save.

TOOLS

USING THE VOICE COMMANDS

Your phone is equipped with an AVC (Advanced Voice Commands) feature. This feature allows you to make calls or use the phone's functions by simply using your voice. All you have to do is talk into the phone and the phone will recognize your voice and complete tasks by itself.

1. Press the OK Key [MENU], select **Settings & Tools** and press the OK Key. Select **Tools**, press the OK Key, select **Voice Commands** then press the OK Key.

 **Shortcut:** With the flip open, press the Voice Commands Key on the left side of your phone to access the Voice Commands.

2. The phone displays the **Voice Commands** menu and prompts you to say the name of the command you want to use. To complete your task, simply follow the voice prompts. You can speak the name of the command after you hear a beep.

 You can hear a beep in the **Tone Only Mode** (Settings & Tools > Phone Settings > Voice Commands Settings > Prompts > Mode > Tones Only) while you can see a prompt without a beep sound in the **Prompts** or **Readout**.

3. Select either **Call <Name or #>**, **Send <MSG Type>**, **Go To <Menu>**, **Check <Item>**, **Contact <Name>**, **Redial**, **My Verizon** or **Help** and press the OK Key.
4. When it recognizes one of these commands, the phone launches the associated application. If the phone does not hear a command within approximately eight seconds, AVC mode will turn itself off.

CALL <NAME OR #>:

Use the **Call** command to voice dial a name from your Contact List or a phone number. When dialing a number, pronounce each digit, but do not pause noticeably between the digits.

1. Press the OK Key [MENU], select **Settings & Tools** and press the OK Key. Select **Tools**, press the OK Key, select **Voice Commands** then press the OK Key.

 **Shortcut:** With the flip open, press the Voice Commands Key on the left side of your phone to access the Voice Commands.

2. You will hear **Please say a command** and the **Voice Commands** menu will be displayed.
3. If calling a contact from your list, say **Call <Name>**. Your phone will ask you to confirm the name you said. Say **Yes** if it was repeated correctly. That phone number will be dialed. If there is more than one number saved for that contact, you will be asked to confirm which number to dial.

Examples: - Call Tom Smith, - Call 617-555-1212, - Call Bob Carson's mobile, - Call Dee Harper at Home.

SEND <MSG TYPE>:

Use the **Send** command to send a text or other type of message to a specified name or number.

1. Press the OK Key [MENU], select **Settings & Tools** and press the OK Key. Select **Tools**, press the OK Key, select **Voice Commands** then press the OK Key.

 **Shortcut:** With the flip open, press the Voice Commands Key on the left side of your phone to access the Voice Commands.

2. You will hear **Please say a command** and the **Voice Commands** menu will be displayed.
3. Say **Send** followed immediately by one of **Text**, **Picture** or **Voice**.

Examples: - Send Text Tom Smith, - Send Picture to Dee Harper's Mobile.

01

02

03

04

05

GO TO <MENU>:

Use the **Go To** command to open an application on your phone. You can say **Go To** by itself and be prompted to say the application name or you can skip the prompt by saying **Go To** followed by the application name.

1. Press the OK Key [MENU], select **Settings & Tools** and press the OK Key. Select **Tools**, press the OK Key, select **Voice Commands** then press the OK Key.

 **Shortcut:** With the flip open, press the Voice Commands Key on the left side of your phone to access the Voice Commands.

2. You will hear **Please say a command** and the **Voice Commands** menu will be displayed.
3. Say **Go To** followed immediately by one of the application names. For example **Airplane Mode**, **Alarm Clock**, **Alert Sounds**, or **Apps**.

CHECK <ITEM>:

The **Check** command lets you check status information for your phone. You can say **Check** or **Check Status** to see and hear all status information.

1. Press the OK Key [MENU], select **Settings & Tools** and press the OK Key. Select **Tools**, press the OK Key, select **Voice Commands** then press the OK Key.

 **Shortcut:** With the flip open, press the Voice Commands Key on the left side of your phone to access the Voice Commands.

2. You will hear **Please say a command** and the **Voice Commands** menu will be displayed.
3. Say **Check** followed immediately by one of the following: **Status**, **Voicemail**, **Messages**, or **Missed Calls** and so on.

CONTACTS <NAME>:

Use the **Contacts** command to retrieve and display information for any name stored in your Contact List.

1. Press the OK Key [MENU], select **Settings & Tools** and press the OK Key. Select **Tools**, press the OK Key, select **Voice Commands** then press the OK Key.

 **Shortcut:** With the flip open, press the Voice Commands Key on the left side of your phone to access the Voice Commands.

2. You will hear **Please say a command** and the **Voice Commands** menu will be displayed.
 3. Say **Contact <Name>**.
- Examples:** - Contact Tom Jones.
4. The View Contact page will be displayed for that contact name.

REDIAL:

Use the **Redial** command to redial with the directory number which talks over the phone recently.

1. Press the OK Key [MENU], select **Settings & Tools** and press the OK Key. Select **Tools**, press the OK Key, select **Voice Commands** then press the OK Key.

 **Shortcut:** With the flip open, press the Voice Commands Key on the left side of your phone to access the Voice Commands.

2. You will hear **Please say a command** and the **Voice Commands** menu will be displayed.
3. Say **Redial**.

MY VERIZON:

1. Press the OK Key [MENU], select **Settings & Tools** and press the OK Key. Select **Tools**, press the OK Key, select **Voice Commands** then press the OK Key.

 **Shortcut:** With the flip open, press the Voice Commands Key on the left side of your phone to access the Voice Commands.

2. You will hear **Please say a command** and the **Voice Commands** menu will be displayed.
3. Say **My Verizon**.
4. Your phone will make a web connection.

HELP:

1. Press the OK Key [MENU], select **Settings & Tools** and press the OK Key. Select **Tools**, press the OK Key, select **Voice Commands** then press the OK Key.

 **Shortcut:** In idle mode, press the Voice Commands Key  located on the right side of the phone.

2. You will hear **Please say a command** and the **Voice Commands** menu will be displayed.
3. Say **Help**.
4. The Help guide will be displayed on your phone.
5. Press the OK Key to return to the previous screen.

VOICE COMMANDS SETTINGS**CONFIRM CHOICES:**

When voice recognition is not confident it has recognized a name or number correctly, it will show you a list of up to three choices. You can control when choice lists appear.

1. Press the OK Key [MENU], select **Settings & Tools** and press the OK Key. Select **Tools**, press the OK Key, select **Voice Commands** then press the OK Key.

 **Shortcut:** With the flip open, press the Voice Commands Key on the left side of your phone to access the Voice Commands.

2. Press the Right Soft Key  [Settings], select **Confirm Choices** and press the OK Key.
3. Select **Automatic**, **Always Confirm** or **Never Confirm** and press the OK Key.

SENSITIVITY:

The Sensitivity setting controls how the voice recognition software determines when a spoken word is a match. If you frequently experience the messages **Please Repeat** or **No Match Found**, adjust the sensitivity toward **Reject Less**. If you frequently experience false activations (when the phone recognizes a name you didn't say), adjust the sensitivity toward **Most Sensitive**.

1. Press the OK Key [MENU], select **Settings & Tools** and press the OK Key. Select **Tools**, press the OK Key, select **Voice Commands** then press the OK Key.

 **Shortcut:** With the flip open, press the Voice Commands Key on the left side of your phone to access the Voice Commands.

2. Press the Right Soft Key  [Settings], select **Sensitivity** and press the OK Key.
3. Select **More Sensitive**, **Automatic**, or **Less Sensitive** and press the OK Key.

Adapt Voice:

Voice Commands are speaker independent, which means that no training or adaptation is required. Some users with heavy accents or unusual voice characteristics may find difficulty in achieving high accuracy with speaker independent Voice Commands, so the Adapt Voice feature allows users to dramatically improve the recognition accuracy through adaptation. Users who get acceptable recognition accuracy will find no additional benefit to performing the Adapt Voice adaptation.

1. Press the OK Key [MENU], select **Settings & Tools** and press the OK Key. Select **Tools**, press the OK Key, select **Voice Commands** then press the OK Key.

 **Shortcut:** With the flip open, press the Voice Commands Key on the left side of your phone to access the Voice Commands.

2. Press the Right Soft Key  [Settings], select **Adapt Voice** and press the OK Key.
3. Select **Train Voice** and press the OK Key.
To begin press the OK Key.
 - **Train Voice:** Requires that you make recordings of your voice to customize the voice recognitions system. It will take a few minutes.
4. Wait for the beep and then repeat the sentences using your normal tone of voice.
5. Repeat steps 1 - 4 when you are finished with a full session, you will reach a screen that reads **Adaptation Complete**.

01

02

03

04

05

PROMPTS:

Allows you to select the Voice Commands system characteristics.

1. Press the OK Key [MENU], select **Settings & Tools** and press the OK Key. Select **Tools**, press the OK Key, select **Voice Commands** then press the OK Key.

 **Shortcut:** With the flip open, press the Voice Commands Key on the left side of your phone to access the Voice Commands.

2. Press the Right Soft Key  [Settings], select **Prompts** and press the OK Key.
3. Select **Mode**, **Audio Playback**, or **Timeout** and then press OK Key.
 - **Mode:** Select the Voice Commands system mode from the following:
 - **Prompts:** Read out Voice Commands prompts.
 - **Readout+Alerts:** Read out and Alert tone prompts, dialing digits and menus at the same time.
 - **Readout:** Read out prompts, dialing digits and menus.
 - **Tones Only:** Prompts you with a tone only.
 - **Audio Playback:** Allows audio playback to play through the speakerphone or through the earpiece. Select Speakerphone or Earpiece and then press the OK Key.
 - **Timeout:** You can control how long the system listens for a command before timing out. Select **5 Seconds** or **10 Seconds** and then press the OK Key.

Voice Mode Training:

Allows you to be trained by reading 25 sentences displayed on-screen.

1. Press the OK Key [MENU], select **Settings & Tools** and press the OK Key. Select **Tools**, press the OK Key, select **Voice Commands** then press the OK Key.



 **Shortcut:** With the flip open, press the Voice Commands Key on the left side of your phone to access the Voice Commands.

2. Press the Left Soft Key  [Start Over] to begin with **VoiceMode Training**. See and follow the on-screen instruction.

ABOUT:

1. Press the OK Key [MENU], select **Settings & Tools** and press the OK Key. Select **Tools**, press the OK Key, select **Voice Commands** then press the OK Key.

 **Shortcut:** With the flip open, press the Voice Commands Key on the left side of your phone to access the Voice Commands.





2. Press the Right Soft Key  [Settings], select **About** and press the OK Key.
3. The **Nuance** version appears.
4. Press the Right Soft Key  [Back] to return to the previous screen.

USING THE CALCULATOR



Allows you to perform simple mathematical calculations.

1. Press the OK Key [MENU], select **Settings & Tools** and press the OK Key. Select **Tools**, press the OK Key, select **Calculator** then press the OK Key.

2. Follow the instructions below to calculate $8 \times 6 \div 4 - 2.5 = 9.5$

- Input 8 and press the Directional Key  right.
- Input 6 and press the Directional Key  left.
- Input 4 and press the Directional Key  down.
- Input 2 and press the International Dial Key  to input (.).
- Input 5.
- Press the OK Key and you will see the answer (9.5).

 • Press the Right Soft Key  [Operator] to use the following: (/) / Exponent.

- Press the Left Soft Key  [Clear] to reset.
- To change the displayed number from positive (+) to negative (-) and vice versa, press the Vibrate Key .

USING THE CALENDAR

The Calendar tool provides easy and convenient access to your schedule. Simply store your appointments and your phone will alert you to them.

01

02

03

04

05

SETTING THE SCHEDULE

1. Press the OK Key [MENU], select **Settings & Tools** and press the OK Key. Select **Tools**, press the OK Key, select **Calendar** then press the OK Key.
2. Select the scheduled day and press the Left Soft Key [NEW].
 - Select desired options and then press the OK Key [SAVE].

VIEWING EVENT LIST

1. Press the OK Key [MENU], select **Settings & Tools** and press the OK Key. Select **Tools**, press the OK Key, select **Calendar** then press the OK Key.
2. Select the event and press the OK Key [VIEW].

ERASING SAVED EVENT

1. Press the OK Key [MENU], select **Settings & Tools** and press the OK Key. Select **Tools**, press the OK Key, select **Calendar** then press the OK Key.
2. Select the event and press the OK Key [VIEW].
3. Press the Right Soft Key [Options] and then select **Erase**. Press OK key [OK] to erase.

ERASING ALL PASSED EVENTS

1. Press the OK Key [MENU], select **Settings & Tools** and press the OK Key. Select **Tools**, press the OK Key, select **Calendar** then press the OK Key.
2. Select the event and press the OK Key [VIEW].
3. Press the Right Soft Key [Options], select **Erase All Old** and press the OK Key, select **Yes** and press the OK Key.

USING THE ALARM CLOCK

The Alarm Clock tool allows you to set up to three alarms. When you set an alarm, the current time is displayed at the top of the screen. When the alarm goes off, Alarm 1 (or 2 or 3, as applicable) will be displayed on the LCD screen and the alarm will sound.

SETTING THE ALARM

1. Press the OK Key [MENU], select **Settings & Tools** and press the OK Key. Select **Tools**, press the OK Key, select **Alarm Clock** then press the OK Key.
2. Select **Alarm 1**, **Alarm 2** or **Alarm 3** and press the OK Key.
3. Select the desired option and save the alarm by pressing the OK Key [SAVE].

USING THE STOP WATCH

Measures elapsed time for activities.

1. Press the OK Key [MENU], select **Settings & Tools** and press the OK Key. Select **Tools**, press the OK Key, select **Stop Watch** then press the OK Key.
2. Press the OK Key [START] to start.
3. Press the OK Key [STOP] to pause.
4. Press the Right Soft Key [Reset] to reset.

MEASURING MORE THEN ONE EVENT

1. Press the OK Key [START] to start.
2. Press the Right Soft Key [Lap] to stop a time period and continue measuring another one.
3. Press the Right Soft Key [Lap] to stop the second and continue measuring a third one. Repeat this step as necessary.
4. Press the OK Key [STOP] to pause.

 You can record 5 lap times on-screen.

USING THE COUNTDOWN TIMER

Counts down to a time&minutes with alarm

1. Press the OK Key [MENU], select **Settings & Tools** and press the OK Key. Select **Tools**, press the OK Key, select **Countdown Timer** then press the OK Key.
2. Press the Right Soft Key [Edit] to set timer.
3. Adjust the desired time to countdown, and then press the OK Key [SET].
4. Press the OK Key [Start] to start countdown.

01

02

03

04

05

WORLD CLOCK

To display the time and date in pre-programmed cities:

SETTING THE CLOCK

1. Press the OK Key [MENU], select **Settings & Tools** and press the OK Key. Select **Tools**, press the OK Key, select **World Clock** then press the OK Key.
2. Press the Directional Key left or right to select the city.
3. Press the Right Soft Key [Cities] to access the **CITIES LIST**.
4. Select the city and press the OK Key.

SETTING DST (DAYLIGHT SAVING TIME)

1. Press the Left Soft Key [Set DST] to set the DST options.
2. Press **Yes** if you want to set Daylight Saving Time.

USING THE NOTEPAD

Saves your text memo in your phone.

1. Press the OK Key [MENU], select **Settings & Tools** and press the OK Key.
2. Select **Tools**, press the OK Key, select **Notepad** then press the OK Key.
3. Press the Left Soft Key [Add].
4. Enter the text memo by using the keypad.
5. Press the OK Key [SAVE].

USING THE USB MASS STORAGE

Uses your phone as USB mass storage device.

1. Connect the phone with your PC using the USB cable.
2. Press the OK Key [MENU], select **Settings & Tools**.
3. Select **Tools** and then press the OK Key.
4. Select **USB Mass Storage** and press OK Key.
5. When a pop-up window appears on your PC screen, open a folder to view files.
You can copy files from the PC to the memory card, or vice versa.

USING THE G'Z GEAR®

G'zGEAR® provides you of useful tools for outdoor activities.

For information about "Motion Detection," see page 44.

1. Press the OK key [MENU], select **Settings&Tools**, then press the OK key.
2. Select **Tools** and press the OK key, and select **G'zGEAR** then press the OK key.

 **CAUTION:** Do not use G'zGEAR® while engaging in any dangerous sports.

EARTH COMPASS

The Earth Compass measures the direction with the built-in electronic compass.

You can change the following operation modes by pressing the Right Soft Key [Compass].

- **Compass:** The direction measured with the built-in electronic compass is displayed.
- **World Nature:** The compass and natural objects in the direction the handset is facing are displayed on the screen.

WALKING COUNTER

The Walking Counter counts the number of steps you take.

You can change the following operation modes by pressing the Right Soft Key [Walking Counter].

- **Pedometer:** The number of steps you take in a day are measured with the pedometer, and the distance you walked and the estimated number of calories you burned are displayed.
- **Virtual Trek:** The distance you hike is calculated based on the number of steps taken. Your distance hiked, and trail milestones are displayed on the screen.

THERMOMETER

The Thermometer measures the current temperature.

You can change the following operation modes by pressing the Right Soft Key [Thermometer].

- **Thermometer:** The current temperature is displayed in both Fahrenheit and Celsius.

01

02

03

04

05

- **Temperature Comparison:** The current temperature is displayed in both Fahrenheit and Celsius, along with the highest and lowest temperatures from three selected cities in the city list, which is based on the largest city of each state.

TIDES

The Tides displays the high and low tide times.

You can change the following operation modes by pressing the Right Soft Key .

- **One-Day View:** Displays the tidal graph for a single day.
- **Current View:** Displays the current tide and the time appropriate for fishing.

SUNRISE SUNSET

The Sunrise Sunset displays the times of sunrise and sunset.

You can change the following operation modes by pressing the Right Soft Key .

- **Tracking:** Displays the position of the Sun.
- **Day/Night:** Displays the ratio between day and night in numeric and graphic form.

ASTRO CALENDAR

The Astro Calendar displays the moon's phase and date in the lunar cycle, and days until full moon and new moon.

You can change the following operation modes by pressing the Right Soft Key .

- **Lunar Phase:** Displays the phase of the Moon.
- **Cosmic View:** Displays the location of Sun, Moon, and Earth.

STAR GAZER

The Star Gazer displays the stars in the sky and the names of the constellations and major stars.

USING G'zGEAR® WITH THE FLIP CLOSED

You can use the G'zGEAR function when the handset's flip is closed.

1. Press the OK key [**MENU**], select **Settings&Tools**, then press the OK key.
2. Select **Tools** and press the OK key, and select **G'zGEAR** then press the OK key.
3. Close the flip.

SETUP

You can set the G'zGEAR® settings by selecting one of the following options:

- **G_SWITCH:** Enables switching of tools by shaking the handset to the left with the flip open.
- **Save Last Mode:** Displays the previously displayed mode when starting a tool.
- **Backlight:** Keeps the displayed backlight on while G'zGEAR® is active.
- **Pedometer:** Counts your steps with pedometer.
- **Calibration:** Calibrates the electronic compass.
- **Restore Defaults:** Returns G'zGEAR® settings to initial value.

HOW TO USE

You can view the short instruction by selecting the [How to use](#).

BLUETOOTH

Bluetooth technology enables wireless connections between electronic devices. If connected with a Bluetooth Handsfree device, you can use your phone more freely. Since devices with Bluetooth connectivity communicate using radio waves, your phone and the other device do not need to be in direct line-of-sight. The two devices only need to be within 10 meters (30 feet) of each other. The connection can be subject to interference from obstructions such as walls or other electronic devices. This device is compliant with Bluetooth Specification 3.0, supporting the following profiles: Headset, Handsfree, Phonebook Access and Object Push for vCard. To ensure interoperability between other devices supporting Bluetooth technology, use approved enhancements for this model. Check with the manufacturers of other devices to determine their compatibility with this phone. There may be restrictions on using Bluetooth technology

in some locations. Check with your local authorities or Verizon Wireless. If you want more information on this function, visit the Bluetooth Technology organization Web site: <https://www.bluetooth.org/>.

 Features using Bluetooth technology or allowing such features to run in the background while using other features, increase the demand on battery power and reduce the battery life.

BLUETOOTH ON/OFF

To activate Bluetooth:

1. Press the OK Key [MENU], then select **Settings & Tools** and press the OK Key.
2. Select **Bluetooth** and press OK Key.
3. Press the Left Soft Key  [Turn On/Turn Off].



ADD NEW DEVICE

Pairing is the process that allows the handset to locate, establish and register a 1-to-1 connection with the target device.

1. Press the OK Key [Menu], then select **Settings & Tools** and press the OK Key.
2. Select **Bluetooth** and press the OK Key.
3. Select **Add New Device** and press the OK Key.
4. The handset will prompt you with the following message on the screen: **PLACE DEVICE YOU ARE CONNECTING TO IN DISCOVERABLE MODE.** Press the OK Key.
5. The device will appear in the **Add New Device** menu. Select the device to pair to and press the OK Key [PAIR].
6. If applicable, the handset may prompt you for the password. Consult the Bluetooth® accessory (sold separately) instructions for the appropriate passkey (typically 0000, 4 zeroes). Enter the passkey and press the OK Key.

 You do not need to input the passkey for pairing when the passkey of the Bluetooth® Headset or hands-free kit is 0000.

6. The handset will prompt you with the following message on the LCD screen: **Before Connecting To [Device Name]**. If you would like to always confirm before connecting to the Bluetooth device, select **Always Ask**, then press the OK Key. Then the handset will prompt you with the message **“Connect To [Device Name]?”** Select **Yes** and press the OK key. If you do not wish to confirm every time before connecting to the Bluetooth device, select **Always Connect**, then press the OK key.
7. Once connected, you will see the device listed in the Bluetooth menu and the Bluetooth device connected icon will appear at the top of the screen when connected to the Bluetooth device.

 In the Bluetooth menu, you can turn off the device by pressing the Left Soft Key  [Turn Off]. Conversely, you can turn on by pressing the Left Soft Key  [Turn On].







- If multiple devices are displayed, select the device you want to connect to.

OPTIONS

1. Press the OK key [MENU], then select **Settings & Tools** and press the OK key.
2. Select **Bluetooth** and press the OK key.
3. Select the paired device.
4. Press the Right Soft Key  [Options].
5. Select one of the following options, then press the OK Key.
 - **Remove Device:** Removes a device from the pairing list.
 - **Rename Device:** Renames a paired device.
 - **Incoming Security:** Sets permissions for connecting an incoming device.
 - **Service Discovery:** Searches for the services that the selected device supports.
 - **Device Info:** Displays device information.
6. Or, press the OK Key to access **Send Name Card, Send Picture, Send Video, Send Calendar, Event, Get Name Card, Exchange Name Card, Browse / Get Files.**

Select the desired option and press the OK Key to access the following:

- **Disconnect:** Disconnects the connected device.

- **Send Name Card:** Allows you to send name cards stored in Contacts to a selected device.
 1. Press the Directional Key  up or down to highlight a desired contact or contacts, then press the OK Key [MARK]. If you want to change your selections, press the OK key [UNMARK] to deselect your selections.
 2. Press the Left Soft Key  [Done]. If you want to send all the name cards, press the Right Soft Key  [Send All].
- **Get Name Card:** Get name cards from the selected device.
- **Send Picture:** Allows you to send photos to a selected device.
 1. Press the Directional Key  up, down, left or right to highlight a desired photo or photos, then press the OK Key [MARK]. If you want to change your selections, press the OK key [UNMARK] to deselect your selections.
 2. Press the Left Soft Key [Done]. If you want to send all the photos, press the Right Soft Key  [Send All].
- **Send Video:** Allows you to send videos to a selected device.
 1. Press the Directional key  up, down, left or right to highlight a desired video or videos, then press the OK Key [MARK]. If you want to change your selections, press the OK key [UNMARK] to deselect your selections.
 2. Press the Left Soft Key [Done]. If you want to send all the videos, press the Right Soft Key  [Send All].
- **Browse/Get Files:** Allows you to get files from the selected device.

SETTINGS

MY PHONE NAME:

To edit the Bluetooth® name of your phone:

1. Press the OK Key [MENU], select **Bluetooth** and press the OK Key.
2. Press the Right Soft Key  [Options].
3. Select **My Phone Name** and press the OK Key.
4. Enter a new custom name.
5. Press the OK Key to save.

DISCOVERY MODE:

Set your device to be searched for by other Bluetooth® devices in the area.

1. Press the OK Key [MENU], select **Bluetooth** and press the OK Key.
2. Press the Right Soft Key  [Options].
3. Select **Discovery Mode** and press the OK Key.



If Bluetooth power is not on, you will be prompted to turn it on in order to proceed.

4. Select **On** or **Off** and press the OK Key.

SUPPORTED PROFILES:

To view brief descriptions of the profiles supported by the phone:

1. Press the OK Key [MENU], select **Bluetooth** and press the OK Key.
2. Press the Right Soft Key  [Options].
3. Select **Supported Profiles** and press the OK Key.
4. Select a profile and press the OK Key [VIEW] for further details.

AUTO PAIR HANDSFREE:

1. Press the OK Key [MENU], select **Bluetooth** and press the OK Key.
2. Press the Right Soft Key  [Options].
3. Select **Auto Pair Handsfree** and press the OK Key.
4. Select **On** or **Off** and press the OK Key.

KEYGUARD SETTINGS

Locks the external phone keys.

1. Press the OK Key [MENU], select **Settings & Tools**.
2. Select **Keyguard Settings** and then press the OK Key.
3. Set the desired Keyguard setting options and press the OK Key [SET].

01

02

03

04

05

PTT SETTINGS

Allows you to set PTT settings

1. Press the OK Key [MENU], select **Settings & Tools**.
2. Select **PTT Settings** and then press the OK Key.
3. Select **PTT Mode**, **PTT Alert**, **Missed Call Notification**, or **Tutorial** and then press OK Key.
4. Choose the desired option and then press OK Key [SET].

SOUND SETTINGS**EASY SET-UP**

To set up phone sounds using the Easy Set up Wizard:

1. Press the OK Key [MENU], select **Settings & Tools** and press the OK Key. Select **Sounds Settings**, press the OK Key, select **Easy Set-up** then press the OK Key.
2. Select the sound settings including the **CALL SOUNDS**, **KEYPAD VOLUME**, **TEXT MESSAGE ALERT**, **MEDIA MSG ALERT**, **VOICEMAIL MSG ALERT** and press OK Key [SET].
To skip the step, press the Right Soft Key \Rightarrow [Skip].

CALL SOUNDS

Set ringtones for types of incoming calls.

CALL RINGTONE

1. Press the OK Key [MENU], select **Settings & Tools** and press the OK Key. Select **Sounds Settings**, press the OK Key, select **Call Sounds** then press the OK Key.
2. Select **Call Ringtone** and press the OK Key.
3. Select a ringtone and press the OK Key to save the sound.
To listen to the ringtone, press the Left Soft Key \Leftarrow [Play].

CALL VIBRATE

1. Press the OK Key [MENU], select **Settings & Tools** and press the OK Key. Select **Sounds Settings**, press the OK Key, select **Call Sounds** then press the OK Key.

2. Select **Call Vibrate** and press the OK Key.
3. Select **On** or **Off** and press the SET Key.

CALLER ID READOUT

1. Press the OK Key [MENU], select **Settings & Tools** and press the OK Key. Select **Sounds Settings**, press the OK Key, select **Call Sounds** then press the OK Key.
2. Select **CALLER ID READOUT** and press the OK Key.
3. Select **Ring Only**, **Caller ID + Ring** or **Name Repeat** and press the OK Key.

ALERT SOUNDS

To select the alert type for a new message:

1. Press the OK Key [MENU], select **Settings & Tools** and press the OK Key. Select **Sounds Settings**, press the OK Key, select **Alert Sounds** then press the OK Key.
2. Select the desired alert sound you want to change press OK Key [SET].
3. Select access the following options and press the OK Key.

KEYPAD VOLUME

To set the keypad volume:

1. Press the OK Key [MENU], select **Settings & Tools** and press the OK Key. Select **Sounds Settings**, press the OK Key, select **Keypad Volume** then press the OK Key.
2. Adjust the volume by pressing the Directional Key up or down and press the OK Key.

DIGIT DIAL READOUT

The Digit Dial Readout setting controls if digits are read out loud when you type in a phone number with the keypad.

1. Press the OK Key [MENU], select **Settings & Tools** and press the OK Key. Select **Sounds Settings**, press the OK Key, select **Digit Dial Readout** then press the OK Key.

01

02

03

04

05

2. Select **On** or **Off** and press the OK Key.

SERVICE ALERTS

To set any of the three Alert options to either On or Off:

1. Press the OK Key [**MENU**], select **Settings & Tools** and press the OK Key. Select **Sounds Settings**, press the OK Key, select **Service Alerts** then press the OK Key.
2. Select access the following options and press the OK Key.
 - **ERI**: The Enhanced Roaming Indicator (ERI) feature displays a text banner on the display screen informing the handset user of which systems the wireless device is using as compared to the service plan they purchased.
The ERI Banner text changes to tell a customer if they are using the: Verizon Wireless Network, Extended Network or Roaming.
 - **Minute Beep**: Alerts you every minute during a call.
 - **Call Connect**: Alerts you when the call is connected.
 - **Software Update**: Alert when the software update is made.
3. Select **On** or **Off** and press the OK Key.

POWER ON/OFF

To set the phone to sound a tone when the phone is powered on/off:

1. Press the OK Key [**MENU**], select **Settings & Tools** and press the OK Key. Select **Sounds Settings**, press the OK Key, select **Power On/Off** then press the OK Key.
2. Select **Power On** or **Power Off** and press the OK Key.
3. Select **On** or **Off** and press the OK Key.

DISPLAY SETTINGS

EASY SET-UP

To set up display options using the Easy Set-up Wizard:

1. Press the OK Key [**MENU**], select **Settings & Tools** and press the OK Key. Select **Display Settings**, press the OK Key, select **Easy Set-up** then press the OK Key.

2. Select the display settings including the **MAIN WALLPAPER, FRONT WALLPAPER, DISPLAY THEMES, MENU LAYOUT, DIAL FONTS, MAIN CLOCK FORMAT, FRONT CLOCK FORMAT**, and press OK Key [**SET**].
To skip the step, press the Right Soft Key \square [**Skip**].

BANNER

PERSONAL BANNER:

The **Personal Banner** can be up to 16 characters and is displayed on your phone's screen in idle mode.

1. Press the OK Key [**MENU**], select **Settings & Tools** and press the OK Key. Select **Display Settings**, press the OK Key, select **Banner** then press the OK Key.
2. Select **Personal Banner** and press the OK Key.
3. Enter the banner text (up to 16 characters).
4. Select **Text Color**, select the desired color and press the OK Key.

ERI BANNER:

If you use ERI Service, ERI Text is shown on the sub banner.

1. Press the OK Key [**MENU**], select **Settings & Tools** and press the OK Key. Select **Display Settings**, press the OK Key, select **Banner** then press the OK Key.
2. Select **ERI Banner** and press the OK Key.
3. Select **On** or **Off** and press the OK Key.



ERI stands for Enhanced Roaming Indicator. The ERI banner will usually tell you if you are on Verizon service area or if you are roaming/on another network.

BACKLIGHT

To set the duration for backlight illumination for the Main Screen and Keypad:

1. Press the OK Key [**MENU**], select **Settings & Tools** and press the OK Key. Select **Display Settings**, press the OK Key, select **Backlight** then press the OK Key.
2. Select **Display** or **Keypad** and press the OK Key.

01

02

03

04

05

3. Select the following menu options:

Duration: 7 Seconds, 15 Seconds, 30 Seconds, Always On

Brightness: Medium, Medium High, High, Low, Medium Low

-  • Brightness menu is not available for Keypad backlight.
- Even if **Always On** is selected for the **Backlight** setting, the backlight will turn off when the phone is closed.

WALLPAPER

To choose the kind of Main LCD or Front LCD background to be displayed on the phone:

MAIN SCREEN:

To choose the kind of Main LCD background to be displayed on the phone:

1. Press the OK Key [**MENU**], select **Settings & Tools** and press the OK Key. Select **Display Settings**, press the OK Key, select **Wallpaper** then press the OK Key.
2. Select **Main Screen** and press the OK Key.
3. Select **My Pictures, My Videos, or Animation**.
4. Select the desired image or animation and press the OK Key. To view the image, press the Left Soft Key [≡] [**View**].
5. Press the OK key [**SET**] to save as main wallpaper.

FRONT SCREEN:

To choose the Front LCD background to be displayed on the phone:

1. Press the OK Key [**MENU**], select **Settings & Tools** and press the OK Key. Select **Display Settings**, press the OK Key, select **Wallpaper** then press the OK Key.
2. Select **Front Screen** and press the OK Key.
3. Select the image and press the OK Key. To view the image, press the Left Soft Key [≡] [**View**].
4. Press the OK key [**SET**] to save as main wallpaper.

DISPLAY THEMES

To choose the background screen:

1. Press the OK Key [**MENU**], select **Settings & Tools** and press the OK Key. Select **Display Settings**, press the OK Key, select **Display Themes** then press the OK Key.
2. Select the desired theme and press the OK Key [**SET**]. To preview the themes, press the Left Soft Key [≡] [**Preview**].
3. To view help for the themes, press the Right Soft Key [≡] [**Help**].

MAIN MENU SETTINGS

To change the Main Menu layout and type:

TO SET LIST MENU LAYOUT:

1. Press the OK Key [**MENU**], select **Settings & Tools** and press the OK Key. Select **Display Settings**, press the OK Key, select **Main Menu Settings** then press the OK Key.
2. Select **Menu Layout** and press the OK Key.
3. Select **Tab, List, or Grid** for the menu layout.
4. Press the Left Soft Key [≡] [**Preview**] to view the layout.
5. Press the OK Key [**SET**] to confirm.

REPLACE MENU ITEMS

1. Press the OK Key [**MENU**], select **Settings & Tools** and press the OK Key. Select **Display Settings**, press the OK Key, select **Main Menu Settings** then press the OK Key.
2. Select **Replace Menu Items** and press the OK Key.
3. Select the item you want to replace, then press the OK Key [**EDIT**].
4. Select in the list the item you want to replace it with then press the OK key [**SET**].
5. To view help for the replace menu item, press the Right Soft Key [≡] [**Help**].

6. Press the Left Soft Key [Done] to save your changes.

POSITION MENU ITEMS

1. Press the OK Key [MENU], select **Settings & Tools** and press the OK Key. Select **Display Settings**, press the OK Key, select **Main Menu Settings** then press the OK Key.
2. Select **Position Menu Items** and press the OK Key.
3. Select the item to move and press the OK Key [MOVE].
4. Move highlight to desired position by using the directional keys and press the OK Key [SWAP].
5. Press the Right Soft Key [Help] to view help information.
6. Press the Left Soft Key [Done] to save your changes.

RESET MENU SETTINGS

1. Press the OK Key [MENU], select **Settings & Tools** and press the OK Key. Select **Display Settings**, press the OK Key, select **Main Menu Settings** then press the OK Key.
2. Select **Reset Menu Settings** and press the OK Key.
3. Select the following options and press the OK Key.
 - **Menu Layout:** Restore menu layout to the initial menu layout.
 - **Menu Items:** Restore menu items to the initial content of the menu.
 - **Item Positions:** Restore menu items to their initial positions.
 - **All:** Restore all to your initial menu settings.
4. Press the Right Soft Key [Help] to view help information.

 If you change this setting, you will not be able to follow the instructions as provided in the manual.

DIAL FONTS

To set the font size:

1. Press the OK Key [MENU], select **Settings & Tools** and press the OK Key. Select **Display Settings**, press the OK Key, select **Dial Fonts** then press the OK Key.

2. Select **Normal** or **Large Only** and press the OK Key. To preview the font size, press the Left Soft Key [Preview].

MENU FONT SIZE

To set the menu font size:

1. Press the OK Key [MENU], select **Settings & Tools** and press the OK Key. Select **Display Settings**, press the OK Key, select **Menu Font Size** then press the OK Key.
2. Select **Normal** or **Large** and press the OK Key.

CLOCK FORMAT

To choose the kind of clock to be displayed on the Main LCD or Front LCD screen:

1. Press the OK Key [MENU], select **Settings & Tools** and press the OK Key. Select **Display Settings**, press the OK Key, select **Clock Format** then press the OK Key.
2. Select **Main Clock** or **Front Clock** and press the OK Key.
3. Select one of the following options and press the OK Key.
 - **Main Clock:** Set the **Clock Format** and **Clock Font Color**.
 - **Front Clock:** Set the type of clock for the front screen. **Digital** is the default setting.

PHONE SETTINGS

AIRPLANE MODE

In Airplane Mode, all menu functions can be accessed except making calls, receiving calls, data connection and Bluetooth®. Activating Airplane Mode will disable all wireless communications. In Airplane Mode, services that support location on functions are temporarily disabled.

1. Press the OK Key [MENU], select **Settings & Tools** and press the OK Key. Select **Phone Settings**, press the OK Key, select **Airplane Mode** then press the OK Key.
2. Select **On** or **Off** and press the OK Key.

01

02

03



04

05

SET SHORTCUTS

Your phone offers you the option of assigning a shortcut key (**Directional Key left, right, up and down**) to a favorite or often-used function. In addition, choose menu settings for each of the shortcut options under **Set Directional Keys** (Directional Key right).

1. Press the OK Key [MENU], select **Settings & Tools** and press the OK Key. Select **Phone Settings**, press the OK Key, select **Set Shortcuts** then press the OK Key.
2. Select **Set My Shortcuts** and press the OK Key.
3. Select **Shortcut 1, Shortcut 2, Shortcut 3** or **Shortcut 4** and press the OK Key [SET].
4. Select the desired option and press the OK Key.

 The **Download Application Alphabet** option only appears when you have downloaded Brew Applications. In idle mode, pressing the Directional Key right will display the My Shortcuts screen. On the My Shortcuts screen, you can select a function and press the OK Key to access the function. On the My Shortcuts screen, you can relocate a function by pressing the Right Soft Key  [Move], pressing the Directional Key up or down for placement and pressing the OK Key [SAVE]. Or you can press the Left Soft Key  [Settings] to **Set My Shortcuts** or **Set Directional Keys**.

RESETTING MY SHORTCUTS:

To restore My Shortcuts to their original defaults:

1. Press the OK Key [MENU], select **Settings & Tools** and press the OK Key. Select **Phone Settings**, press the OK Key, select **Set Shortcuts** then press the OK Key.
2. Select **Set My Shortcuts** and press the OK Key.
3. Select **Shortcut 1, Shortcut 2, Shortcut 3** or **Shortcut 4** and press the Right Soft Key  [Options].
4. Select **Reset Shortcut (1, 2, 3 or 4)** or **Reset My Shortcuts** and press the OK Key.
5. Select **Yes** and press the OK Key.

SET DIRECTIONAL KEYS:

1. Press the OK Key [MENU], select **Settings & Tools** and press the OK Key. Select **Phone Settings**, press the OK Key, select **Set Shortcuts** then press the OK Key.
2. Select **Set Directional Keys** and press the OK Key.
3. Select **UP Directional Key, LEFT Directional Key** or **DOWN Directional Key** and press the OK Key [SET].
4. Select the desired option and press the OK Key.

RESETTING THE DIRECTIONAL KEY SETTINGS:

Use the following procedure to return to the default Directional Key settings.

1. Press the OK Key [MENU], select **Settings & Tools** and press the OK Key. Select **Phone Settings**, press the OK Key, select **Set Shortcuts** then press the OK Key.
2. Select **Set Directional Keys** and press the OK Key.
3. Select **UP Directional Key, LEFT Directional Key** or **DOWN Directional Key** and press the Right Soft Key  [Options].
4. Select **Reset (UP, LEFT or DOWN) Key** or **Reset Directional Keys** and press the OK Key.
5. Select **Yes** and press the OK Key.

SET RED SIDE KEY

1. Press the OK Key [MENU], select **Settings & Tools** and press the OK Key. Select **Phone Settings**, press the OK Key, select **Set Shortcuts** then press the OK Key.
2. Select **Set Red Side Key** and press the OK Key.
3. Select the desired option and press the OK Key.

VOICE COMMANDS SETTINGS

For information about Voice Commands Settings, See page 88.

LANGUAGE

To set the bilingual feature to either English or Español:

1. Press the OK Key [MENU], select **Settings & Tools** and press the OK Key. Select **Phone Settings**, press the OK Key, select **Language** then press the OK Key.
2. Select **English** or **Español** and press the OK Key.

TIME & DATE

To set the time and date for your phone:

1. Press the OK Key [MENU], select **Settings & Tools** and press the OK Key. Select **Display Settings**, press the OK Key, select **Time & Date** then press the OK Key.
2. From the **Date** field, enter the date.
3. Scroll to the **Time** field and enter the time. Press the Left Soft Key [≡] to change the **am** and **pm** setting.
4. Scroll to the **DST** field and press the Directional Key left or right to select **On** or **Off**.
5. Scroll to the **Current Time Zone** field, then press the Left Soft Key [≡] [Set]. Select the appropriate city and press the OK Key.
6. Press the OK Key to save.

 This menu appears only in **GSM** or **Global** Mode.

LOCATION

1. Press the OK Key [MENU], select **Settings & Tools** and press the OK Key. Select **Phone Settings**, press the OK Key, select **Location** then press the OK Key.
2. Select access the following options and press the OK Key.
 - **On**: Your location is now available to the network.
 - **E911 Only**: Your location will be hidden from the network and applications, except for 911.

 When the **Lock Setting** is selected for Location Settings under Restrictions on the Security Menu, you will need to enter a Lock Code. The default lock code is the last 4 digits of your mobile telephone number.

CURRENT COUNTRY

The Current Country menu allows you to select your current location.

1. Press the OK Key [MENU], select **Settings & Tools** and press the OK Key. Select **Phone Settings**, press the OK Key, select **Current Country** then press the OK Key.
2. Enter a country name in the **Go To** field or select the appropriate country and press the OK Key [SET].

SECURITY

The Security menu allows you to electronically secure the phone. The default lock code is the last 4 digits of your Mobile Telephone Number.

EDIT CODES:

To set a new Lock Code:

1. Press the OK Key [MENU], select **Settings & Tools** and press the OK Key. Select **Phone Settings**, press the OK Key, select **Security** then press the OK Key.
2. Enter the four-digit lock code and press the OK Key. The default lock code is last 4 digits of your mobile telephone number.
3. Select **Edit Codes** and press the OK Key.
4. Select access the following options and press the OK Key.
 - **Phone Only**: Allows you to edit the lock code for **Phone Security**. The default lock code is the last 4 digits of your mobile telephone number.
 - **Calls & Services**: Allows you to edit the lock code for **Restrictions**. The default lock code is the last 4 digits of your mobile telephone number.
5. If **Phone Only** is selected, enter the new four-digit code in the **Enter New Code** field. Enter the new four-digit code again in the **Re-enter New Code** field and press the OK Key.
6. If **Calls & Services** is selected, enter the current lock code in the **Enter Current Code** field. Enter the new four-digit code in the **Enter New Code** field. Enter the new four-digit code again in the **Re-enter New Code** field and press the OK Key.

01

02

03

04

05

RESTRICTIONS:

Use the following procedure to configure Location Setting, Calls and Messages restrictions.

1. Press the OK Key [MENU], select **Settings & Tools** and press the OK Key. Select **Phone Settings**, press the OK Key, select **Phone Security** then press the OK Key.
2. Enter the four-digit lock code and press the OK Key. The default lock code is last 4 digits of your mobile telephone number.
3. Select **Restrictions** and press the OK Key.
4. Enter the four-digit lock code again and press the OK Key. The default lock code is the last 4 digits of your mobile telephone number.
5. Select one of the following settings and press the OK Key:
 - **Location Setting:** Select **Unlock Setting** or **Lock Setting** and press the OK Key.
 - **Calls:** Select **Incoming Calls** or **Outgoing Calls** and press the OK Key. Select **Allow All**, **Contacts Only**, or **Block All** and press the OK Key.
 - **Messages:** Select **Incoming Messages** or **Outgoing Messages** and press the OK Key. Select **Allow All** or **Block All** and press the OK Key.
 - **Dial-Up Modem:** Select **Allow** or **Block** and press the OK Key.

PHONE LOCK SETTING:

This setting specifies whether the phone should be locked whenever it is turned on. Lock Mode prevents the unauthorized use of your phone. Once the phone is locked, it is in restricted mode until the Lock Code is entered. You can still make emergency calls.

1. Press the OK Key [MENU], select **Settings & Tools** and press the OK Key. Select **Phone Settings**, press the OK Key, select **Phone Security** then press the OK Key.
2. Enter the four-digit lock code and press the OK Key. The default lock code is last 4 digits of your mobile telephone number.
3. Select **Phone Lock Setting** and press the OK Key.

4. Select from the following options and press the OK Key:
 - **Unlocked:** Phone is unlocked.
 - **On Power Up:** Phone will lock when it is turned on.

LOCK PHONE NOW:

1. Press the OK Key [MENU], select **Settings & Tools** and press the OK Key. Select **Phone Settings**, press the OK Key, select **Phone Security** then press the OK Key.
2. Enter the four-digit lock code and press the OK Key. The default lock code is the last 4 digits of your mobile telephone number.
3. Select **Lock Phone Now** and press the OK Key.
4. To unlock the phone, in idle mode, press the Right Soft Key  [Unlock] and enter the four-digit lock code and press the OK Key.

RESTORE PHONE:

To delete all User Data and restore all settings to their initial defaults:

1. Press the OK Key [MENU], select **Settings & Tools** and press the OK Key. Select **Phone Settings**, press the OK Key, select **Phone Security** then press the OK Key.
2. Enter the four-digit lock code and press the OK Key. The default lock code is the last 4 digits of your mobile telephone number.
3. Select **Restore Phone** and press the OK Key.
4. Select **Yes** and press the OK Key.
5. Follow the on-screen prompt and press the OK Key. The phone will turn off and then back on again automatically.

SIM SECURITY

The SIM Security menu allows you to select the security settings for your SIM card.

 The SIM Card is pre-installed in your phone.

01

02

03

04

05

PIN CODE:

Allows you to edit/lock your PIN code:

1. Press the OK Key [**MENU**], select **Settings & Tools** and press the OK Key. Select **Phone Settings**, press the OK Key, select **SIM Security** then press the OK Key.
2. Enter the four-digit SIM lock code and press the OK Key. The default SIM lock code is last 4 digits of your mobile telephone number.
3. Select **PIN Code** and press the OK Key.
4. Select one of the following options and press the OK Key:
 - **PIN Lock:** Allows you to lock/unlock the PIN code.
 - **Edit PIN Code:** Allows you to edit the PIN code. (PIN number must be locked before editing.)

 Verizon Wireless offers 24/7 Customer Support while you are traveling abroad. If you need Customer Service assistance or Technical Support for your global device, dial:

While in the United States

- 1-800-922-0204 from any phone or your wireless phone.
- *611 from your wireless phone while in the U.S.

While outside of the United States

- +1 (908) 559-4899

SIM LOCK:

Allows you to lock/unlock the SIM code.

1. Press the OK Key [**MENU**], select **Settings & Tools** and press the OK Key. Select **Phone Settings**, press the OK Key, select **SIM Security** then press the OK Key.
2. Enter the four-digit SIM lock code and press the OK Key. The default SIM lock code is last 4 digits of your mobile telephone number.
3. Select **SIM Lock** and press the OK Key.
4. Select either **Unlocked** or **Locked** and press the OK Key.
5. To unlock the SIM card, enter the PIN Unlock Code and press the OK Key.

SYSTEM SELECT

Your phone is Quad-Band Capable, which means it will work in both CDMA and GSM Destinations. While in the United States or on other CDMA roaming networks, use your phone in Verizon CDMA Mode. Use your phone in Global Mode while outside of the U.S.. You must have a SIM card in order to select GSM and Global Mode. The SIM Card is pre-installed in your phone.

You can set your phone to search or roam on another network when you are not in your home area. Leave this setting as default unless you want to alter the system selection as instructed by your service provider.

1. Press the OK Key [**MENU**], select **Settings & Tools** and press the OK Key. Select **Phone Settings**, press the OK Key, select **System Select** then press the OK Key.
2. Select either **CDMA Settings** or **GSM Settings** and press the OK Key.
 - **Network Mode:** Select either **CDMA Mode**, **GSM Mode** or **Global Mode** and press the OK Key.
 - **CDMA Settings:** Select either **Automatic B**, **Automatic A** or **Home Only** and press the OK Key.
 - **GSM Settings:** Select either **Automatic** or **Manual** and press the OK Key.

 For a complete list of destinations, please visit: www.verizonwireless.com/goglobal. Network mode allows you to select from CDMA, GSM or Global network modes.

 When your phone is in Verizon (CDMA) mode, it does not necessarily mean that you are on the Verizon Wireless Network. You may roam on other carrier's networks domestically and internationally when your phone is in Verizon (CDMA) mode. For more information, visit: www.verizonwireless.com.

MOTION DETECTION

Helps you set your phone to respond to your actions.

1. Press the OK Key [**MENU**], select **Settings & Tools** and press the OK Key.
2. Select **Phone Settings**, press the OK Key, select **Motion Detection** then press the OK Key.

01

02

03

04

05

3. Select either **G'zGEAR** or **My Pics/Videos** and press the OK Key.
 - **G'zGEAR**: When this feature is On, shaking the phone to the left or right will change the Tool in the G'zGEAR Application.
 - **My Pics/Videos**: When this feature is On, shaking the Phone to the left or right will perform a page scroll in the My Pictures/Videos Gallery.

CALL SETTINGS

ANSWER OPTIONS

To determine how to handle an answered call:

1. Press the OK Key [MENU], select **Settings & Tools** and press the OK Key. Select **Call Settings**, press the OK Key, select **Answer Options** then press the OK Key.
2. Select either **Flip Open**, **Any Key** or **Auto w/ Handsfree** and press the OK Key [MARK].
3. Press the Left Soft Key [Done].

- **Flip Open** is the default setting for this device.
- When the phone is closed, the **Auto w/ Handsfree** Mode will not function, except when a headset is connected.
- **Auto w/ Handsfree** will function after about five seconds and is available only when connected to a headset or hands-free device.
- To answer all incoming calls, press the SEND Key [Send].

AUTO RETRY

Set the length of time the phone waits before automatically redialing a number when the attempted call fails.

1. Press the OK Key [MENU], select **Settings & Tools** and press the OK Key. Select **Call Settings**, press the OK Key, select **Auto Retry** then press the OK Key.
2. Select either **10 Seconds**, **30 Seconds**, **60 Seconds** or **Off** and press the OK Key.

TTY MODE

You can attach a TTY device to your phone enabling you to communicate with parties also using a TTY device. A phone with TTY support is able to translate typed characters to voice. Voice can also be translated into characters and then displayed on the TTY.

1. Press the OK Key [MENU], select **Settings & Tools** and press the OK Key. Select **Call Settings**, press the OK Key, select **TTY Mode** then press the OK Key.
2. Select either **TTY Full**, **TTY + Talk**, **TTY + Hear** or **TTY Off** and press the OK Key.

ONE TOUCH DIAL

To initiate a speed dial call by holding down the speed dial digit:

1. Press the OK Key [MENU], select **Settings & Tools** and press the OK Key. Select **Call Settings**, press the OK Key, select **One Touch Dial** then press the OK Key.
2. Select **On** or **Off** and press the OK Key.

 If **One Touch Dial** is disabled, speed dial numbers designated in your contacts will not function.

VOICE PRIVACY

Turn the voice privacy feature On or Off.

1. Press the OK Key [MENU], select **Settings & Tools** and press the OK Key. Select **Call Settings**, press the OK Key, select **Voice Privacy** then press the OK Key.
2. Select **On** or **Off** and press the OK Key.

PC CONNECTIONS

Allows you to set PC connection setting.

1. Press the OK Key [MENU], select **Settings & Tools** and press the OK Key.
2. Select **Call Settings**, press the OK Key, select **PC Connections** then press the OK Key.
3. Select either **USB**, **Bluetooth** or **Close** and press the OK Key.

01

02

03

04

05

DTMF TONES

To set the Key Tone length and touch tone playback speed:

1. Press the OK Key [MENU], select **Settings & Tools** and press the OK Key. Select **Call Settings**, press the OK Key, select **DTMF Tones** then press the OK Key.
2. Select one of the following options and press the OK Key.
 - **Normal**: Sends out a tone for a fixed period of time even if you continue to press the key.
 - **Long**: Sends out a continuous tone for the duration the key is pressed and held.

 The setting of **DTMF Tones** are changed to Normal in GSM mode.

PTT MODE

Allows you to set PTT mode setting.

1. Press the OK Key [MENU], select **Settings & Tools** and press the OK Key.
2. Select **Call Settings**, press the OK Key, select **PTT Mode** then press the OK Key.
3. Select either **On** or **Off** and press the OK Key.

ASSISTED DIALING

This menu allows you to select Assisted Dialing for a destination where you are making a call.

1. Press the OK Key [MENU], select **Settings & Tools** and press the OK Key. Select **Call Settings**, press the OK Key, select **Assisted Dialing** then press the OK Key.

 Press the Right Soft Key [Help], to view the help menu.

2. Under **Assisted Dialing**, press the Directional Key left or right to select **On** or **Off**.
3. When selecting **On**, scroll down to the **Reference Country** field, and then press the Left Soft Key [Set]. Enter a country name in the **Go To** field or select the appropriate country and press the OK Key.
4. While on the screen with the list of Countries, press the Left Soft Key [Details] to edit the following options:
 - Country Code
 - IDD Prefix

- NDD Prefix
- Area/City Code
- National Number Length

5. Press the OK Key to save.

 When Assisted Dialing is On, the number edit screen will display "Assisted Dialing On" when dialing a number.

NOISE REDUCTION

To reduce the noise while talking on the headset:

1. Press the OK Key [MENU], select **Settings & Tools** and press the OK Key.
2. Select **Call Settings**, press the OK Key, select **Noise Reduction** then press the OK Key.
3. Select **On** or **Off** and then press the OK Key.
 - If you select **On**, "NOISE REDUCTION SET" message appears on the display.

MEMORY

USING THE SAVE OPTIONS

Allows you to set save options.

1. Press the OK Key [MENU], select **Settings & Tools** and press the OK Key.
2. Select **Memory**, press the OK Key, select **Save Options** then press the OK Key.
3. Select either **Pictures**, **Videos**, or **Sounds** and press the OK Key.
4. Choose the desired save option and press OK Key [SET].

USING THE PHONE MEMORY OPTIONS

Allows you to view the phone memory information and erase/move the file location.

1. Press the OK Key [MENU], select **Settings & Tools** and press the OK Key.
2. Select **Memory**, press the OK Key, select **Phone Memory** then press the OK Key.
3. Select the desired option and press OK Key to view memory information.
4. Press Right Soft Key [Options] to erase or move to different location.

01

02

03

04

05

USING THE CARD MEMORY OPTIONS

Allows you to view the card memory information and erase/move the file location.

1. Press the OK Key [MENU], select **Settings & Tools** and press the OK Key.
2. Select **Memory**, press the OK Key, select **Card Memory** then press the OK Key.
3. Select the desired option and press OK Key to view memory information.
4. Press Right Soft Key [Options] to erase or move to different location.

USB MODE

Allows you to choose the USB mode.

1. Press the OK Key [MENU], select **Settings & Tools** and press the OK Key.
2. Select **USB Mode**, press the OK Key, select **Modem Mode**, **Mass Storage**, or **Ask On Plug**.

If you choose **Ask On Plug**, you will be prompted to select the USB mode when connecting your phone with PC.

PHONE INFO**MY NUMBER**

To view your phone number:

1. Press the OK Key [MENU], select **Settings & Tools** and press the OK Key. Select **Phone Info**, press the OK Key, select **My Number** then press the OK Key.
2. Select one of the following options and press the OK Key:
 - **CDMA Number**: Displays the MDN, MIN and service provider.
 - **GSM Number**: Displays the Mobile Device Number.
3. Press the OK Key to return to the previous screen.

SW/HW VERSION

1. Press the OK Key [MENU], select **Settings & Tools** and press the OK Key. Select **Phone Info**, press the OK Key, select **SW/HW Version** then press the OK Key.

- Displays the followings: **Software Version**, **PRL Version**, **ERI Version**, **Browser Version**, **Media Center Version**, **MSUI Version**, **HW Version**, **MEID**, **Software Update Client**, **BT Mac Address**, **Warranty Date Code**.
2. Press the OK Key to return to the previous screen.

ICON GLOSSARY

To view all the icons and their meanings:

1. Press the OK Key [MENU], select **Settings & Tools** and press the OK Key. Select **Phone Info**, press the OK Key, select **Icon Glossary** then press the OK Key.
2. Press the OK Key to return to the previous screen.
For details on icons, see page 12.

SOFTWARE UPDATE

The update phone firmware (software) option allows you to download and update the software in your phone automatically. Only the internal software is updated; no contacts entries or other information saved to your phone will be deleted.

STATUS:

To check the latest software download or update status:

1. Press the OK Key [MENU], select **Settings & Tools** and press the OK Key. Select **Phone Info**, press the OK Key, select **Software Update** then press the OK Key.
2. Select **Status** and press the OK Key.

CHECK NEW:

To check Download Server for new Software updates:

1. Press the OK Key [MENU], select **Settings & Tools** and press the OK Key. Select **Phone Info**, press the OK Key, select **Software Update** then press the OK Key.
2. Select **Check New** and press the OK Key.

OPERATING SYSTEM

To view the operating system information:

1. Press the OK Key [MENU], select **Settings & Tools** and press the OK Key.
2. Select **Phone Info**, press the OK Key, select **Operating System** then press the OK Key to view the operating system information.

SIM INFO

To view the SIM ID number for your phone.

1. Press the OK Key [MENU], select **Settings & Tools** and press the OK Key. Select **SIM Info** and press the OK Key.
2. The SIM ID number is displayed.
3. Press the OK Key to return to the previous screen.

DATA MANAGER

To select whether to access data roaming during trips:

1. Press the OK Key [MENU], then press **Settings & Tools**, then **Data Manager**.
2. Select "1. **Global Data Roaming Access**," then press the OK Key.
3. Select Allow access for all trips, Allow access only for this trip or Deny data roaming access, then press the OK Key [SET].
 - Data access during trips outside the local may result in significantly higher charger.

TUTORIAL

Introduces the basic concepts and features of the **Push To Talk** (PTT), **G'zGEAR, Voice Dictation**, and **Message Readout** function.

1. Press the OK Key [MENU], select **Settings & Tools** and press the OK Key.
2. Select **Tutorial**, press the OK Key, select the desired option.
3. Press the Right Soft Key [Next] to continue, or the Left Soft Key [Back] to view the previous page.

SET UP WIZARD

To set up options using the Set up Wizard:

1. Press the OK Key [MENU], select **Settings & Tools** and press the OK Key. Select Set-up Wizard and press the OK Key.
2. Select the setting options including **Call Sound, Display Themes, Menu Layout, Main Clock Format, or Front Clock Format** and press the OK Key [SET].
3. To skip the step, press the Right Soft Key ∇ [Skip].

01

02

03

04

05

SAFETY AND WARRANTY 5

This chapter addresses the safety guidelines and precautions to follow when operating your phone. Before operating your phone, please be aware of all the safety details. This chapter contains the terms and conditions of services and the warranty for your phone. Please review them thoroughly.

SAFETY INFORMATION FOR WIRELESS
HANDHELD PHONES
SAFETY INFORMATION FOR FCC RF
EXPOSURE
SAR INFORMATION

HEARING AID COMPATIBILITY (HAC) FOR
WIRELESS TELECOMMUNICATIONS DEVICES
FDA CONSUMER UPDATE
AVOID POTENTIAL HEARING LOSS
FCC COMPLIANCE INFORMATION
12 MONTH LIMITED WARRANTY



C781

SAFETY INFORMATION FOR WIRELESS HANDHELD PHONES

READ THIS INFORMATION BEFORE USING YOUR HANDHELD PORTABLE CELLULAR TELEPHONE

EXPOSURE TO RADIO FREQUENCY SIGNALS

Your wireless handheld portable telephone is a low power radio transmitter and receiver. When it is ON, it receives and also sends out radio frequency (RF) signals. In August 1996, the Federal Communications Commissions (FCC) adopted RF exposure guidelines with safety levels for handheld wireless phones. Those guidelines are consistent with the safety standards previously set by both U.S. and international standards bodies:

ANSI C95.1 (1992) *

NCRP Report 86 (1986) *

ICNIRP (1996) *

Those standards were based on comprehensive and periodic evaluations of the relevant scientific literature. For example, over 120 scientists, engineers, and physicians from universities, government health agencies, and industry reviewed the available body of research to develop the ANSI Standard (C951).

The design of your phone complies with the FCC guidelines (and those standards).

1*: American National Standards Institute.

2*: National Council on Radiation Protection and Measurements.

3*: International Commission on Nonionizing Radiation Protection.

ANTENNA SAFETY

Use only the supplied or an approved replacement antenna. Unauthorized antennas, modifications, or attachments could impair call quality, damage the phone, or result in violation of FCC regulations. Please contact your local dealer for replacement antenna.

Do not use the phone with a damaged antenna. If a damaged antenna comes into contact with the skin, a minor burn may result. Please contact your local dealer for replacement antenna.

DRIVING SAFETY

Talking on the phone while driving is extremely dangerous and is illegal in some states. Remember, safety comes first. Check the laws and regulations on the use of phones in the areas where you drive. Always obey them. Also, if using your phone while driving, please:

- Give full attention to driving. Driving safely is your first responsibility.
- Use hands-free operation, if available.
- Pull off the road and park before making or answering a call, if driving conditions so require.

If you must use the phone while driving, please use one-touch, speed dialing, and auto answer modes.

An airbag inflates with great force. DO NOT place objects, including both installed or portable wireless equipment, in the area over the airbag or in the air bag deployment area. If in-vehicle wireless equipment is improperly installed and the air bag inflates, serious injury could result.

 **WARNING:** Failure to follow these instructions may lead to serious personal injury and possible property damage.

ELECTRONIC DEVICES

Your wireless handheld portable telephone is a low power radio transmitter and receiver. When it is ON, it receives and also sends out radio frequency (RF) signals. Most modern electronic equipment is shielded from RF energy. However, certain electronic equipment may not be shielded against the RF signals from your wireless phone. Therefore, use of your phone must be restricted in certain situations.

01

02

03

04

05

PACEMAKERS

The Health Industry Manufacturers Association recommends that a minimum separation of six (6") inches be maintained between a handheld wireless phone and a pacemaker to avoid potential interference with the pacemaker. These recommendations are consistent with the independent research by and recommendations of Wireless Technology Research. Persons with pacemakers:

- ALWAYS keep the phone more than six inches from your pacemaker when the phone is turned on.
- Do not carry the phone in a breast pocket.
- Use the ear opposite the pacemaker to minimize the potential for interference.
- If you have any reason to suspect that interference is taking place, turn your phone OFF immediately.

HEARING AIDS

Some digital wireless phones may interfere with some hearing aids. In the event of such interference, you may want to consult your service provider (or call the customer service line to discuss alternatives).

OTHER MEDICAL DEVICES

If you use any other personal medical device, consult the manufacturer of your device to determine if they are adequately shielded from external RF energy.

Your physician may be able to assist you in obtaining this information. Turn your phone OFF in healthcare facilities when any regulations posted in these areas instruct you to do so. Hospitals or healthcare facilities may be using equipment that could be sensitive to external RF energy.

VEHICLES

RF signals may affect improperly installed or inadequately shielded electronic systems in motor vehicles. Check with the manufacturer or its representative regarding your vehicle. You should also consult the manufacturer of any equipment that has been added to your vehicle.

POSTED FACILITIES

Turn your phone OFF where posted notices so require.

OTHER SAFETY GUIDELINES

AIRCRAFT

FCC regulations prohibit using your phone while in the air. Turn your phone OFF before boarding an aircraft. Always request and obtain prior consent and approval of an authorized airline representative before using your phone aboard an aircraft.

Always follow the instructions of the airline representative whenever using your phone aboard an aircraft, to prevent any possible interference with airborne electronic equipment.

BLASTING AREAS

To avoid interfering with blasting operations, turn your phone OFF when in a "blasting area" or in areas posted: "Turn off two-way radio." Obey all signs and instructions.

POTENTIALLY EXPLOSIVE ATMOSPHERES

Turn your phone OFF when in any area with a potentially explosive atmosphere and obey all signs and instructions. Sparks in such areas could cause an explosion or fire resulting in bodily injury or even death.

01

02

03

04

05

Areas with a potentially explosive atmosphere are often, but not always, clearly marked. They include fueling areas such as gas stations; below deck on boats; fuel or chemical transfer or storage facilities; vehicles using liquefied petroleum gas (such as propane or butane); areas where the air contains chemicals or particles, such as grain, dust, or metal powders; and any other area where you would normally be advised to turn off your vehicle's engine.

PRECAUTIONS

Your Handheld Portable Telephone is a high quality piece of equipment. Before operating, read all instructions and cautionary markings on (1) USB AC Adapter (2) Battery and (3) Product Using Battery.

Failure to follow the directions below could result in serious bodily injury and/or property damage due to battery liquid leakage, fire or rupture.

- DO NOT use this equipment in an extreme environment where high temperature or high humidity exists.
- DO NOT abuse the equipment. Avoid striking, shaking or shocking. When not using, lay down the unit to avoid possible damage due to instability.
- DO NOT expose this equipment to rain or spilled beverages.
- DO NOT use unauthorized accessories.
- DO NOT disassemble the phone or its accessories. If service or repair is required, return unit to an authorized PCD cellular service center. If unit is disassembled, the risk of electric shock or fire may result.
- DO NOT short-circuit the battery terminals with metal items etc.

SAFETY INFORMATION FOR FCC RF EXPOSURE

WARNING! READ THIS INFORMATION BEFORE USING

CAUTIONS

In August 1996 the Federal Communications Commission (FCC) of the United States with its action in Report and Order FCC 96-326 adopted an updated safety standard for human exposure to radio frequency electromagnetic energy emitted by FCC regulated transmitters. Those guidelines are consistent with the safety standard previously set by both U.S. and international standards bodies. The design of this phone complies with the FCC guidelines and these international standards.

BODY-WORN OPERATION

This device was tested for typical body-worn operations with the back of the phone kept 2 cm. from the body. To maintain compliance requirements, use only belt-clips, holsters or similar accessories that maintain a 2.0 cm separation distance between the user's Body and the back of the phone, including the antenna.

The use of belt-clips, holsters and similar accessories should not contain metallic components in its assembly. The use of accessories that do not satisfy these requirements may not comply with FCC RF exposure requirements, and should be avoided.



For more information about RF exposure, please visit the FCC website at <http://www.fcc.gov>

01

02

03

04

05

SAR INFORMATION

THIS MODEL PHONE MEETS THE GOVERNMENT'S REQUIREMENTS FOR EXPOSURE TO RADIO WAVES.

Your wireless phone is a radio transmitter and receiver. It is designed and manufactured not to exceed the emission limits for exposure to radiofrequency (RF) energy set by the Federal Communications Commission of the U.S. Government. These limits are part of comprehensive guidelines and establish permitted levels of RF energy for the general population. The guidelines are based on standards that were developed by independent scientific organizations through periodic and thorough evaluation of scientific studies. The standards include a substantial safety margin designed to assure the safety of all persons, regardless of age and health.

The exposure standard for wireless mobile phones employs a unit of measurement known as the Specific Absorption Rate, or SAR. The SAR limit set by the FCC is 1.6 W/kg. * Tests for SAR are conducted with the phone transmitting at its highest certified power level in all tested frequency bands. Although the SAR is determined at the highest certified power level, the actual SAR level of the phone while operating can be well below the maximum value. This is because the phone is designed to operate at multiple power levels so as to use only the power required to reach the network. In general, the closer you are to a wireless base station antenna, the lower the power output.

Before a phone model is available for sale to the public, it must be tested and certified to the FCC that it does not exceed the limit established by the government adopted requirement for safe exposure. The tests are performed in positions and locations (e.g., at the ear and worn on the body) as required by the FCC for each model.

The highest SAR value for this model phone when tested for use at the ear is 0.995 W/Kg and when worn on the body, as described in this user guide, is 1.12 W/Kg. (Body-worn measurements differ among phone models, depending upon available accessories and FCC requirements). While there may be differences between the SAR levels of various phones and at various positions, they all meet the government requirement for safe exposure.

The SAR testing for Body-worn operation was performed with a belt clip that provided a 2.0 cm separation. The User's Manual indicates that any holsters/clips used with this device should contain no metallic components.

The FCC has granted an Equipment Authorization for this model phone with all reported SAR levels evaluated as in compliance with the FCC RF exposure guidelines.

SAR information on this model phone is on file with the FCC and can be found under the Display Grant section of <http://www.fcc.gov/oet/ea> after searching on JYC78.

Additional information on Specific Absorption Rates (SAR) can be found on the Cellular Telecommunications Industry Association (CTIA) web-site at <http://www.ctia.org>.

* In the United States and Canada, the SAR limit for mobile phones used by the public is 1.6 watts/kg (W/kg) averaged over one gram of tissue. The standard incorporates a substantial margin of safety to give additional protection for the public and to account for any variations in measurements.

01

02

03

04

05

HEARING AID COMPATIBILITY (HAC) FOR WIRELESS TELECOMMUNICATIONS DEVICES

PCD'S COMMITMENT

PCD believes that all of our customers should be able to enjoy the benefits of digital wireless technologies.

We are committed to providing a selection of compatible devices for our customers who wear hearing aids.

THIS PHONE HAS A HAC RATING OF M4/T4.

WHAT IS HEARING AID COMPATIBILITY?

The Federal Communications Commission has implemented rules and a rating system designed to enable people who wear hearing aids to more effectively use these wireless telecommunications devices. The standard for compatibility of digital wireless phones with hearing aids is set forth in American National Standard Institute (ANSI) standard C63.19. There are two sets of ANSI standards with ratings from one to four (four being the best rating): an "M" rating for reduced interference making it easier to hear conversations on the phone when using the hearing aid microphone, and a "T" rating that enables the phone to be used with hearing aids operating in the telecoil mode thus reducing unwanted background noise.

HOW WILL I KNOW WHICH WIRELESS PHONES ARE HEARING AID COMPATIBLE?

The Hearing Aid Compatibility rating is displayed on the wireless phone box.

A phone is considered Hearing Aid Compatible for acoustic coupling (microphone mode) if it has an "M3" or "M4" rating.



A digital wireless phone is considered Hearing Aid Compatible for inductive coupling (telecoil mode) if it has a "T3" or "T4" rating.

HOW WILL I KNOW IF MY HEARING AID WILL WORK WITH A PARTICULAR DIGITAL WIRELESS PHONE?

You'll want to try a number of wireless phones so that you can decide which works the best with your hearing aids. You may also want to talk with your hearing aid professional about the extent to which your hearing aids are immune to interference, if they have wireless phone shielding, and whether your hearing aid has a HAC rating.

FOR MORE INFORMATION ABOUT HEARING AIDS AND DIGITAL WIRELESS PHONE

- FCC Hearing Aid Compatibility and Volume Control – <http://www.fcc.gov/cgb/dro/hearing.html>
- Hearing Loss Association of America – <http://www.hearingloss.org/learn/cellphonetech.asp>
- CTIA – <http://www.accesswireless.org/hearingaid/>
- Gallaudet University, RERC – <http://tap.gallaudet.edu/voice>

FDA CONSUMER UPDATE



U.S. FOOD AND DRUG ADMINISTRATION - CENTER FOR DEVICES AND RADIOLOGICAL HEALTH
CONSUMER UPDATE ON WIRELESS PHONES

01

02

03

04

05

1. Do wireless phones pose a health hazard?

The available scientific evidence does not show that any health problems are associated with using wireless phones. There is no proof, however, that wireless phones are absolutely safe. Wireless phones emit low levels of radiofrequency energy (RF) in the microwave range while being used. They also emit very low levels of RF when in the idle mode. Whereas high levels of RF can produce health effects (by heating tissue), exposure to low level RF that does not produce heating effects causes no known adverse health effects. Many studies of low level RF exposures have not found any biological effects. Some studies have suggested that some biological effects may occur, but such findings have not been confirmed by additional research. In some cases, other researchers have had difficulty in reproducing those studies, or in determining the reasons for inconsistent results.

2. What is FDA's role concerning the safety of wireless phones?

Under the law, FDA does not review the safety of radiation-emitting consumer products such as wireless phones before they can be sold, as it does with new drugs or medical devices. However, the agency has authority to take action if wireless phones are shown to emit radiofrequency energy (RF) at a level that is hazardous to the user. In such a case, FDA could require the manufacturers of wireless phones to notify users of the health hazard and to repair, replace or recall the phones so that the hazard no longer exists. Although the existing scientific data do not justify FDA regulatory actions, FDA has urged the wireless phone industry to take a number of steps, including the following:

- Support needed research into possible biological effects of RF of the type emitted by wireless phones;
- Design wireless phones in a way that minimizes any RF exposure to the user that is not necessary for device function;

and

- Cooperate in providing users of wireless phones with the best possible information on possible effects of wireless phone use on human health.

FDA belongs to an interagency working group of the federal agencies that have responsibility for different aspects of RF safety to ensure coordinated efforts at the federal level. The following agencies belong to this working group:

- National Institute for Occupational Safety and Health
- Environmental Protection Agency
- Federal Communications Commission
- Occupational Safety and Health Administration
- National Telecommunications and Information Administration

The National Institutes of Health participates in some inter-agency working group activities, as well. FDA shares regulatory responsibilities for wireless phones with the Federal Communications Commission (FCC). All phones that are sold in the United States must comply with FCC safety guidelines that limit RF exposure. FCC relies on FDA and other health agencies for safety questions about wireless phones. FCC also regulates the base stations that the wireless phone networks rely upon. While these base stations operate at higher power than do the wireless phones themselves, the RF exposures that people get from these base stations are typically thousands of times lower than those they can get from wireless phones. Base stations are thus not the subject of the safety questions discussed in this document.

3. What kinds of phones are the subject of this update?

The term "wireless phone" refers here to hand-held wireless phones with built-in antennas, often called "cell," "mobile," or "PCS" phones. These types of wireless phones can expose the user to measurable radiofrequency energy (RF) because of the short distance between the phone and the user's head.

01

02

03

04

05

These RF exposures are limited by Federal Communications Commission safety guidelines that were developed with the advice of FDA and other federal health and safety agencies. When the phone is located at greater distances from the user, the exposure to RF is drastically lower because a person's RF exposure decreases rapidly with increasing distance from the source. The so-called "cordless phones," which have a base unit connected to the telephone wiring in a house, typically operate at far lower power levels, and thus produce RF exposures far below the FCC safety limits.

4. What are the results of the research done already?

The research done thus far has produced conflicting results, and many studies have suffered from flaws in their research methods. Animal experiments investigating the effects of radiofrequency energy (RF) exposures characteristic of wireless phones have yielded conflicting results that often cannot be repeated in other laboratories. A few animal studies, however, have suggested that low levels of RF could accelerate the development of cancer in laboratory animals. However, many of the studies that showed increased tumor development used animals that had been genetically engineered or treated with cancer-causing chemicals so as to be predisposed to develop cancer in the absence of RF exposure. Other studies exposed the animals to RF for up to 22 hours per day. These conditions are not similar to the conditions under which people use wireless phones, so we don't know with certainty what the results of such studies mean for human health. Three large epidemiology studies have been published since December 2000. Between them, the studies investigated any possible association between the use of wireless phones and primary brain cancer, glioma, meningioma, or acoustic neuroma, tumors of the brain or salivary gland, leukemia, or other cancers. None of the studies demonstrated the existence of any harmful health effects from wireless phone RF exposures.

However, none of the studies can answer questions about long-term exposures, since the average period of phone use in these studies was around three years.

5. What research is needed to decide whether RF exposure from wireless phones poses a health risk?

A combination of laboratory studies and epidemiological studies of people actually using wireless phones would provide some of the data that are needed. Lifetime animal exposure studies could be completed in a few years. However, very large numbers of animals would be needed to provide reliable proof of a cancer promoting effect if one exists. Epidemiological studies can provide data that is directly applicable to human populations, but 10 or more years' follow-up may be needed to provide answers about some health effects, such as cancer. This is because the interval between the time of exposure to a cancer-causing agent and the time tumors develop - if they do - may be many, many years. The interpretation of epidemiological studies is hampered by difficulties in measuring actual RF exposure during day-to-day use of wireless phones. Many factors affect this measurement, such as the angle at which the phone is held, or which model of phone is used.

6. What is FDA doing to find out more about the possible health effects of wireless phone RF?

FDA is working with the U.S. National Toxicology Program and with groups of investigators around the world to ensure that high priority animal studies are conducted to address important questions about the effects of exposure to radiofrequency energy (RF). FDA has been a leading participant in the World Health Organization International Electromagnetic Fields (EMF) Project since its inception in 1996. An influential result of this work has been the development of a detailed agenda of research needs that has driven the establishment of new research programs around the world.

The Project has also helped develop a series of public information documents on EMF issues. FDA and the Cellular Telecommunications & Internet Association (CTIA) have a formal Cooperative Research and Development Agreement (CRADA) to do research on wireless phone safety. FDA provides the scientific oversight, obtaining input from experts in government, industry, and academic organizations. CTIA-funded research is conducted through contracts to independent investigators. The initial research will include both laboratory studies and studies of wireless phone users. The CRADA will also include a broad assessment of additional research needs in the context of the latest research developments around the world.

7. How can I find out how much radiofrequency energy exposure I can get by using my wireless phone?

All phones sold in the United States must comply with Federal Communications Commission (FCC) guidelines that limit radiofrequency energy (RF) exposures. FCC established these guidelines in consultation with FDA and the other federal health and safety agencies. The FCC limit for RF exposure from wireless telephones is set at a Specific Absorption Rate (SAR) of 1.6 watts per kilogram (1.6 W/kg). The FCC limit is consistent with the safety standards developed by the Institute of Electrical and Electronic Engineering (IEEE) and the National Council on Radiation Protection and Measurement. The exposure limit takes into consideration the body's ability to remove heat from the tissues that absorb energy from the wireless phone and is set well below levels known to have effects. Manufacturers of wireless phones must report the RF exposure level for each model of phone to the FCC. The FCC website (<http://www.fda.gov> (under "c" in the subject index, select **Cell Phones > Research**)) gives directions for locating the FCC identification number on your phone so you can find your phone's RF exposure level in the online listing.

8. What has FDA done to measure the radiofrequency energy coming from wireless phones?

The Institute of Electrical and Electronic Engineers (IEEE) is developing a technical standard for measuring the radiofrequency energy (RF) exposure from wireless phones and other wireless handsets with the participation and leadership of FDA scientists and engineers. The standard, "Recommended Practice for Determining the Spatial-Peak Specific Absorption Rate (SAR) in the Human Body Due to Wireless Communications Devices: Experimental Techniques," sets forth the first consistent test methodology for measuring the rate at which RF is deposited in the heads of wireless phone users. The test method uses a tissue-simulating model of the human head. Standardized SAR test methodology is expected to greatly improve the consistency of measurements made at different laboratories on the same phone. SAR is the measurement of the amount of energy absorbed in tissue, either by the whole body or a small part of the body. It is measured in watts/kg (or milliwatts/g) of matter. This measurement is used to determine whether a wireless phone complies with safety guidelines.

9. What steps can I take to reduce my exposure to radiofrequency energy from my wireless phone?

If there is a risk from these products—and at this point we do not know that there is—it is probably very small. But if you are concerned about avoiding even potential risks, you can take a few simple steps to minimize your exposure to radiofrequency energy (RF). Since time is a key factor in how much exposure a person receives, reducing the amount of time spent using a wireless phone will reduce RF exposure.

- If you must conduct extended conversations by wireless phone every day, you could place more distance between your body and the source of the RF, since the exposure level drops off dramatically with distance.

For example, you could use a headset and carry the wireless phone away from your body or use a wireless phone connected to a remote antenna. Again, the scientific data do not demonstrate that wireless phones are harmful. But if you are concerned about the RF exposure from these products, you can use measures like those described above to reduce your RF exposure from wireless phone use.

10. What about children using wireless phones?

The scientific evidence does not show a danger to users of wireless phones, including children and teenagers. If you want to take steps to lower exposure to radiofrequency energy (RF), the measures described above would apply to children and teenagers using wireless phones. Reducing the time of wireless phone use and increasing the distance between the user and the RF source will reduce RF exposure. Some groups sponsored by other national governments have advised that children be discouraged from using wireless phones at all. For example, the government in the United Kingdom distributed leaflets containing such a recommendation in December 2000. They noted that no evidence exists that using a wireless phone causes brain tumors or other ill effects. Their recommendation to limit wireless phone use by children was strictly precautionary; it was not based on scientific evidence that any health hazard exists.

11. What about wireless phone interference with medical equipment?

Radiofrequency energy (RF) from wireless phones can interact with some electronic devices. For this reason, FDA helped develop a detailed test method to measure electromagnetic interference (EMI) of implanted cardiac pacemakers and defibrillators from wireless telephones.

This test method is now part of a standard sponsored by the Association for the Advancement of Medical Instrumentation (AAMI). The final draft, a joint effort by FDA, medical device manufacturers, and many other groups, was

completed in late 2000. This standard will allow manufacturers to ensure that cardiac pacemakers and defibrillators are safe from wireless phone EMI. FDA has tested hearing aids for interference from handheld wireless phones and helped develop a voluntary standard sponsored by the Institute of Electrical and Electronic Engineers (IEEE). This standard specifies test methods and performance requirements for hearing aids and wireless phones so that no interference occurs when a person uses a “compatible” phone and a “compatible” hearing aid at the same time. This standard was approved by the IEEE in 2000. FDA continues to monitor the use of wireless phones for possible interactions with other medical devices. Should harmful interference be found to occur, FDA will conduct testing to assess the interference and work to resolve the problem.

12. Where can I find additional information?

For additional information, please refer to the following resources:

- FDA web page on wireless phones
(<http://www.fda.gov/Radiation-EmittingProducts/RadiationEmittingProductsandProcedures/HomeBusinessandEntertainment/CellPhones/default.htm>)
- Federal Communications Commission (FCC) RF Safety Program
(<http://www.fcc.gov/oet/rfsafety>)
- International Commission on Non-Ionizing Radiation Protection
(<http://www.icnirp.de>)
- World Health Organization (WHO) International EMF Project
(<http://www.who.int/peh-emf/en/>)
- National Radiological Protection Board (UK)
(<http://www.hpa.org.uk/radiation/>)

AVOID POTENTIAL HEARING LOSS

Prolonged exposure to loud sounds (including music) is the most common cause of preventable hearing loss. Some scientific research suggests that using portable audio devices, such as portable music players and cellular telephones, at high volume settings for long durations may lead to permanent noise-induced hearing loss. This includes the use of headphones (including headsets, earbuds and Bluetooth® or other wireless devices). Exposure to very loud sound has also been associated in some studies with tinnitus (a ringing in the ear), hypersensitivity to sound and distorted hearing. Individual susceptibility to noise-induced hearing loss and other potential hearing problems varies.

The amount of sound produced by a portable audio device varies depending on the nature of the sound, the device, the device settings and the headphones. You should follow some commonsense recommendations when using any portable audio device:

- Set the volume in a quiet environment and select the lowest volume at which you can hear adequately.
- When using headphones, turn the volume down if you cannot hear the people speaking near you or if the person sitting next to you can hear what you are listening to.
- Do not turn the volume up to block out noisy surroundings. If you choose to listen to your portable device in a noisy environment, use noise-cancelling headphones to block out background environmental noise.
- Limit the amount of time you listen. As the volume increases, less time is required before your hearing could be affected.
- Avoid using headphones after exposure to extremely loud noises, such as concerts, that might cause temporary hearing loss. Temporary hearing loss might cause unsafe volumes to sound normal.

- Do not listen at any volume that causes you discomfort. If you experience ringing in your ears, hear muffled speech or experience any temporary hearing difficulty after listening to your portable audio device, discontinue use and consult your doctor.

YOU CAN OBTAIN ADDITIONAL INFORMATION ON THIS SUBJECT FROM THE FOLLOWING SOURCES:

AMERICAN ACADEMY OF AUDIOLOGY

11730 Plaza American Drive, Suite 300

Reston, VA 20190

Voice: 800-AAA-2336

Email: infoaud@audiology.org

Internet: <http://www.audiology.org>

NATIONAL INSTITUTE ON DEAFNESS AND OTHER COMMUNICATION DISORDERS NATIONAL INSTITUTES OF HEALTH

31 Center Drive, MSC 2320

Bethesda, MD USA 20892-2320

Voice: (301) 496-7243

Email: nidcdinfo@nidcd.nih.gov

Internet: <http://www.nidcd.nih.gov/health/hearing>

01

02

03

04

05

NATIONAL INSTITUTE FOR OCCUPATIONAL SAFETY AND HEALTH

1600 Clifton Rd

Atlanta

GA 30333. USA

Voice: 1-800-CDC-INFO (1-800-232-4636)

Internet: <http://www.cdc.gov/niosh/topics/noise/default.html>**FCC COMPLIANCE INFORMATION**

This device complies with Part 15 of FCC Rules.

Operation is subject to the following two conditions:

- (1) This device may not cause harmful interference, and
- (2) This device must accept any interference received. Including interference that may cause undesired operation.

INFORMATION TO THE USER

This equipment has been tested and found to comply with the limits for a Class B digital device pursuant to Part 15 of the FCC Rules. These limits are designed to provide reasonable protection against harmful Interference in a residential installation. This equipment generates, uses, and can radiate radio frequency energy and, if not installed and used in accordance with the instructions, may cause harmful Interference to radio communications. However, there is no guarantee that interference will not occur in a particular Installation. If this equipment does cause harmful interference to radio or television reception, which can be determined by turning the equipment off and on, the user is encouraged to try to correct the interference by one or more of the following measures:

- Reorient or relocate the receiving antenna.
Increase the separation between the equipment and receiver.

- Connect the equipment into an outlet of a circuit different from that to which the receiver is connected.
- Consult the dealer or an experienced radio/TV technician for assistance.

 **CAUTION:** Changes or modification not expressly approved by the party responsible for compliance could void the user's authority to operate the equipment. Connecting of peripherals requires the use of grounded shielded signal cables.

12 MONTH LIMITED WARRANTY

Personal Communications Devices, LLC. (the "Company") warrants to the original retail purchaser of this handheld portable cellular telephone, that should this product or any part thereof during normal consumer usage and conditions, be proven defective in material or workmanship that results in product failure within the first twelve (12) month period from the date of purchase, such defect(s) will be repaired or replaced (with new or rebuilt parts) at the Company's option, without charge for parts or labor directly related to the defect(s).

The antenna, keypad, display, rechargeable battery and battery charger, if included, are similarly warranted for twelve (12) months from date of purchase.

This Warranty extends only to consumers who purchase the product in the United States or Canada and it is not transferable or assignable.

This Warranty does not apply to:

- (a) Product subjected to abnormal use or conditions, accident, mishandling, neglect, unauthorized alteration, misuse, improper installation or repair or improper storage;
- (b) Product whose mechanical serial number or electronic serial number has been removed, altered or defaced;

01

02

03

04

05

- (c) Damage from exposure to moisture, humidity, excessive temperatures or extreme environmental conditions;
- (d) Damage resulting from connection to, or use of any accessory or other product not approved or authorized by the Company;
- (e) Defects in appearance, cosmetic, decorative or structural items such as framing and nonoperative parts;
- (f) Product damaged from external causes such as fire, flooding, dirt, sand, weather conditions, battery leakage, blown fuse, theft or improper usage of any electrical source.

The Company disclaims liability for removal or reinstallation of the product, for geographic coverage, for inadequate signal reception by the antenna or for communications range or operation of the cellular system as a whole.

When sending your wireless device to Personal Communications Devices for repair or service, please note that any personal data or software stored on the device may be inadvertently erased or altered. Therefore, we strongly recommend you make a back up copy of all data and software contained on your device before submitting it for repair or service. This includes all contact lists, downloads (i.e. third-party software applications, ringtones, games and graphics) and any other data added to your device. In addition, if your wireless device utilizes a SIM or Multimedia card, please remove the card before submitting the device and store for later use when your device is returned, Personal Communications Devices is not responsible for and does not guarantee restoration of any third-party software, personal information or memory data contained in, stored on, or integrated with any wireless device, whether under warranty or not, returned to Personal Communications Devices for repair or service.

To obtain repairs or replacement within the terms of this Warranty, the product should be delivered with proof of Warranty coverage (e.g. dated bill of sale), the consumer's return address, daytime phone number and/or fax number and complete description of the problem, transportation prepaid, to the Company at the address shown below or to the place of purchase for repair or replacement processing. In addition, for reference to an authorized Warranty station in your area, you may telephone in the United States (800) 229-1235, and in Canada (800) 465-9672 (in Ontario call 416-695-3060).

THE EXTENT OF THE COMPANY'S LIABILITY UNDER THIS WARRANTY IS LIMITED TO THE REPAIR OR REPLACEMENT PROVIDED ABOVE AND, IN NO EVENT, SHALL THE COMPANY'S LIABILITY EXCEED THE PURCHASE PRICE PAID BY PURCHASER FOR THE PRODUCT.

ANY IMPLIED WARRANTIES, INCLUDING ANY IMPLIED WARRANTY OF MERCHANTABILITY OR FITNESS FOR A PARTICULAR PURPOSE, SHALL BE LIMITED TO THE DURATION OF THIS WRITTEN WARRANTY. ANY ACTION FOR BREACH OF ANY WARRANTY MUST BE BROUGHT WITHIN A PERIOD OF 18 MONTHS FROM DATE OF ORIGINAL PURCHASE. IN NO CASE SHALL THE COMPANY BE LIABLE FOR AN SPECIAL CONSEQUENTIAL OR INCIDENTAL DAMAGES FOR BREACH OF THIS OR ANY OTHER WARRANTY, EXPRESS OR IMPLIED, WHATSOEVER. THE COMPANY SHALL NOT BE LIABLE FOR THE DELAY IN RENDERING SERVICE UNDER THIS WARRANTY OR LOSS OF USE DURING THE TIME THE PRODUCT IS BEING REPAIRED OR REPLACED.

No person or representative is authorized to assume for the Company any liability other than expressed herein in connection with the sale of this product.

Some states or provinces do not allow limitations on how long an implied warranty lasts or the exclusion or limitation of incidental or consequential damage so the above limitation or exclusions may not apply to you. This Warranty gives you specific legal rights, and you may also have other rights, which vary from state to state or province to province.

IN USA: Personal Communications Devices, LLC.
555 Wireless Blvd.
Hauppauge, NY 11788
1-800-229-1235

IN CANADA: PCD Communications Canada Ltd.
5535 Eglinton Avenue West, Suite 234
Toronto, Ontario
M9C 5K5
1-800-465-9672

01

02

03

04

05