

---

# Guide to OpenVMS File Applications

Order Number: AA-PV6PE-TK

**June 2002**

This document is intended for application programmers and designers who write programs that use OpenVMS RMS files.

**Revision/Update Information:** This manual supersedes the *Guide to OpenVMS File Applications*, OpenVMS Alpha, Version 7.3 and OpenVMS VAX Version, 7.3

**Software Version:** OpenVMS Alpha Version, 7.3-1  
OpenVMS VAX Version, 7.3

**Compaq Computer Corporation  
Houston, Texas**

---

© 2002 Compaq Information Technologies Group, L.P.

Compaq, the Compaq logo, Alpha, OpenVMS, Tru64, VAX and VMS are trademarks of Compaq Information Technologies Group, L.P. in the U.S. and/or other countries.

Microsoft, Windows, and Windows NT are trademarks of Microsoft Corporation in the U.S. and/or other countries.

Motif, OSF/1, UNIX, and X/Open are trademarks of The Open Group in the U.S. and/or other countries.

All other product names mentioned herein may be trademarks of their respective companies.

Confidential computer software. Valid license from Compaq required for possession, use, or copying. Consistent with FAR 12.211 and 12.212, Commercial Computer Software, Computer Software Documentation, and Technical Data for Commercial Items are licensed to the U.S. Government under vendor's standard commercial license.

Compaq shall not be liable for technical or editorial errors or omissions contained herein. The information in this document is provided "as is" without warranty of any kind and is subject to change without notice. The warranties for Compaq products are set forth in the express limited warranty statements accompanying such products. Nothing herein should be construed as constituting an additional warranty.

ZK4506

The Compaq *OpenVMS* documentation set is available on CD-ROM.

This document was prepared using DECdocument, Version 3.3-1b.

---

# Contents

|   |      |
|---|------|
| <b>Preface</b> .....  | xiii |
| <b>1 Introduction</b>   |      |
| 1.1 File Concepts .....   | 1-1  |
| 1.2 Disk Concepts .....   | 1-3  |
| 1.2.1 Files-11 On-Disk Structure Concepts .....                                     | 1-6  |
| 1.2.2 Files-11 Control Files .....  | 1-8  |
| 1.2.2.1 Index File .....  | 1-8  |
| 1.2.2.2 Storage Bit Map File .....  | 1-9  |
| 1.2.2.3 Bad Block File .....  | 1-10 |
| 1.2.2.4 Master File Directory .....   | 1-10 |
| 1.2.2.5 Core Image File .....   | 1-10 |
| 1.2.2.6 Volume Set List File .....  | 1-10 |
| 1.2.2.7 Continuation File .....   | 1-10 |
| 1.2.2.8 Backup Log File .....   | 1-10 |
| 1.2.2.9 Pending Bad Block Log File .....  | 1-10 |
| 1.2.2.10 Security Profiles File (VAX Only) .....                                    | 1-11 |
| 1.2.3 Files-11 On-Disk Structure Level 1 Versus Structure Level 2 .....             | 1-11 |
| 1.2.4 Physical Structures .....   | 1-12 |
| 1.2.5 CD-ROM Concepts .....   | 1-14 |
| 1.2.5.1 CD-ROM On-Disc Formats .....  | 1-14 |
| 1.2.5.2 Volume Structure .....  | 1-14 |
| 1.2.5.3 Files-11 C/D-ACPs .....   | 1-15 |
| 1.2.5.4 Using DIGITAL System Identifiers on CD-ROM .....                            | 1-16 |
| 1.3 Magnetic Tape Concepts .....  | 1-18 |
| 1.3.1 ANSI-Labeled Magnetic Tape .....  | 1-19 |
| 1.3.1.1 Logical Format of ANSI Magnetic Tape Volumes .....                          | 1-20 |
| 1.3.1.2 RMS Magnetic Tape Ancillary Control Process (MTAACP) .....                  | 1-20 |
| 1.3.1.3 Basic Components of the ANSI Magnetic Tape Format .....                     | 1-20 |
| 1.3.1.4 Volume and File Configurations .....  | 1-23 |
| 1.3.1.5 Volume Labels .....   | 1-27 |
| 1.3.1.5.1 VOL1 Label .....  | 1-27 |
| 1.3.1.5.2 VOL2 Label .....  | 1-27 |
| 1.3.1.6 Header Labels .....   | 1-28 |
| 1.3.1.6.1 HDR1 Label .....  | 1-28 |
| 1.3.1.6.2 HDR2 Label .....  | 1-31 |
| 1.3.1.6.3 HDR3 Label .....  | 1-34 |
| 1.3.1.6.4 HDR4 Label .....  | 1-34 |
| 1.3.1.7 Trailer Labels .....  | 1-34 |
| 1.4 Using Command Procedures to Perform Routine File and Device<br>Operations ..... | 1-34 |
| 1.5 Volume Protection .....   | 1-35 |
| 1.6 RMS (Record Management Services) .....  | 1-35 |

|       |  |      |
|-------|--|------|
| 1.6.1 | File Definition Language (FDL) . . . . .                     | 1-35 |
| 1.6.2 | RMS Data Structures . . . . .                                | 1-36 |
| 1.6.3 | Record Management Services . . . . .                         | 1-36 |
| 1.7   | RMS Utilities . . . . .                                      | 1-37 |
| 1.7.1 | The Analyze/RMS_File Utility . . . . .                       | 1-37 |
| 1.7.2 | The Convert Utility . . . . .                                | 1-37 |
| 1.7.3 | The Convert/Reclaim Utility . . . . .                        | 1-38 |
| 1.7.4 | The Create/FDL Utility . . . . .                             | 1-39 |
| 1.7.5 | The Edit/FDL Utility . . . . .                               | 1-39 |
| 1.8   | Process and System Resources for File Applications . . . . . | 1-40 |
| 1.8.1 | Memory Requirements . . . . .                                | 1-40 |
| 1.8.2 | Process Limits . . . . .                                     | 1-41 |

## 2 Choosing a File Organization

|         |  |      |
|---------|--|------|
| 2.1     | Record Concepts . . . . .  | 2-1  |
| 2.1.1   | Record Access Modes . . . . .  | 2-2  |
| 2.1.1.1 | Sequential Access . . . . .  | 2-3  |
| 2.1.1.2 | Random Access by Key Value or Relative Record Number . . . . .                   | 2-6  |
| 2.1.1.3 | Random Access by Record File Address . . . . .                                   | 2-7  |
| 2.1.2   | Record Formats . . . . .   | 2-8  |
| 2.1.2.1 | Fixed-Length Record Format . . . . .   | 2-9  |
| 2.1.2.2 | Variable-Length Record Format . . . . .  | 2-9  |
| 2.1.2.3 | Variable-Length with Fixed-Length Control Field (VFC) Record<br>Format . . . . . | 2-11 |
| 2.1.2.4 | Stream Record Format . . . . .   | 2-13 |
| 2.2     | File Organization Concepts . . . . .   | 2-13 |
| 2.2.1   | Sequential File Organization . . . . .   | 2-15 |
| 2.2.2   | Relative File Organization . . . . .   | 2-17 |
| 2.2.3   | Indexed File Organization . . . . .  | 2-19 |
| 2.2.3.1 | Sequentially Retrieving Indexed Records . . . . .                                | 2-19 |
| 2.2.3.2 | Index Keys . . . . .   | 2-20 |
| 2.2.3.3 | Other Key Characteristics . . . . .  | 2-20 |
| 2.2.3.4 | Specifying Sort Order . . . . .  | 2-24 |
| 2.2.3.5 | Using Collated Keys . . . . .  | 2-24 |
| 2.2.3.6 | Summary of Indexed File Organization . . . . .                                   | 2-25 |

## 3 Performance Considerations

|           |   |     |
|-----------|---|-----|
| 3.1       | Design Considerations . . . . .                       | 3-1 |
| 3.1.1     | Speed . . . . .                                       | 3-1 |
| 3.1.2     | Space . . . . .                                       | 3-2 |
| 3.1.3     | Shared Access . . . . .                               | 3-3 |
| 3.1.4     | Impact on Applications Design . . . . .               | 3-3 |
| 3.2       | Tuning . . . . .                                      | 3-3 |
| 3.2.1     | File Design Attributes . . . . .                      | 3-4 |
| 3.2.1.1   | Initial File Allocation . . . . .                     | 3-4 |
| 3.2.1.2   | Contiguity . . . . .                                  | 3-4 |
| 3.2.1.3   | Extending a File . . . . .                            | 3-4 |
| 3.2.1.3.1 | Auto Extend Size Selection . . . . .                  | 3-5 |
| 3.2.1.3.2 | Establishing Auto Extend Default Quantities . . . . . | 3-6 |
| 3.2.1.3.3 | Placement and Contiguity of Extends . . . . .         | 3-8 |
| 3.2.1.4   | Truncating a File . . . . .                           | 3-9 |
| 3.2.1.5   | Units of I/O . . . . .                                | 3-9 |

|         |  |      |
|---------|--|------|
| 3.2.1.6 | Multiple Areas for Indexed Files . . . . .             | 3-10 |
| 3.2.1.7 | Bucket Fill Factor for Indexed Files . . . . .         | 3-10 |
| 3.2.2   | Processing Options . . . . .                           | 3-11 |
| 3.2.2.1 | Multiple Buffers . . . . .                             | 3-11 |
| 3.2.2.2 | Deferred-Write Processing . . . . .                    | 3-12 |
| 3.2.2.3 | Global Buffers . . . . .                               | 3-12 |
| 3.2.2.4 | Read-Ahead and Write-Behind Processing . . . . .       | 3-13 |
| 3.3     | Tuning a Sequential File . . . . .                     | 3-13 |
| 3.3.1   | Block Span Option . . . . .                            | 3-13 |
| 3.3.2   | Multiblock Size Option . . . . .                       | 3-13 |
| 3.3.3   | Number of Buffers . . . . .                            | 3-14 |
| 3.3.4   | Global Buffer Option . . . . .                         | 3-14 |
| 3.3.5   | Read-Ahead and Write-Behind Options . . . . .          | 3-15 |
| 3.4     | Tuning a Relative File . . . . .                       | 3-15 |
| 3.4.1   | Bucket Size . . . . .                                  | 3-16 |
| 3.4.2   | Number of Buffers . . . . .                            | 3-16 |
| 3.4.3   | Global Buffer Option . . . . .                         | 3-17 |
| 3.4.4   | Deferred-Write Option . . . . .                        | 3-18 |
| 3.5     | Tuning an Indexed File . . . . .                       | 3-18 |
| 3.5.1   | File Structure . . . . .                               | 3-18 |
| 3.5.1.1 | Prologs . . . . .                                      | 3-18 |
| 3.5.1.2 | Primary Index Structure . . . . .                      | 3-20 |
| 3.5.1.3 | Alternate Index Structure . . . . .                    | 3-22 |
| 3.5.1.4 | Records . . . . .                                      | 3-22 |
| 3.5.1.5 | Keys . . . . .   | 3-23 |
| 3.5.1.6 | Areas . . . . .  | 3-24 |
| 3.5.2   | Optimizing File Performance . . . . .                  | 3-25 |
| 3.5.2.1 | Bucket Size . . . . .                                  | 3-25 |
| 3.5.2.2 | Fill Factor . . . . .                                  | 3-26 |
| 3.5.2.3 | Number of Buffers . . . . .                            | 3-27 |
| 3.5.2.4 | Global Buffers . . . . .                               | 3-28 |
| 3.5.2.5 | Using the Deferred-Write Option . . . . .              | 3-28 |
| 3.6     | Monitoring RMS Performance . . . . .                   | 3-29 |
| 3.6.1   | Enabling RMS Statistics . . . . .                      | 3-29 |
| 3.6.2   | Using RMS Statistics . . . . .                         | 3-30 |
| 3.7     | Processing in an OpenVMS Cluster Environment . . . . . | 3-32 |
| 3.7.1   | OpenVMS Cluster Shared Access . . . . .                | 3-32 |
| 3.7.1.1 | Locking Considerations . . . . .                       | 3-33 |
| 3.7.1.2 | I/O Considerations . . . . .                           | 3-33 |
| 3.7.2   | Performance Recommendations . . . . .                  | 3-33 |

## 4 Creating and Populating Files

|         |  |      |
|---------|--|------|
| 4.1     | File Creation Characteristics . . . . .  | 4-1  |
| 4.1.1   | Using RMS Control Blocks . . . . .       | 4-1  |
| 4.1.1.1 | File Access Block . . . . .              | 4-1  |
| 4.1.1.2 | Extended Attribute Blocks . . . . .      | 4-2  |
| 4.1.2   | Using File Definition Language . . . . . | 4-2  |
| 4.1.2.1 | Using the Edit/FDL Utility . . . . .     | 4-3  |
| 4.1.2.2 | Designing an FDL File . . . . .          | 4-10 |
| 4.1.3   | Using the FDL Routines . . . . .         | 4-13 |
| 4.2     | Creating a File . . . . .                | 4-15 |
| 4.2.1   | Using the Create Service . . . . .       | 4-15 |
| 4.2.2   | Using the Create/FDL Utility . . . . .   | 4-16 |

|         |  |      |
|---------|--|------|
| 4.2.3   | Using the Convert Utility .....              | 4-16 |
| 4.2.4   | Using the FDL\$CREATE Routine .....          | 4-16 |
| 4.3     | Creating and Accessing Tagged Files .....    | 4-19 |
| 4.3.1   | Programming Interface for File Tagging ..... | 4-20 |
| 4.3.2   | Accessing a Tagged File .....                | 4-22 |
| 4.3.2.1 | File Accesses That Do Not Sense Tags .....   | 4-23 |
| 4.3.2.2 | File Accesses That Sense Tags .....          | 4-23 |
| 4.3.3   | Preserving Tags .....                        | 4-25 |
| 4.4     | Defining File Protection .....               | 4-25 |
| 4.4.1   | UIC-Based Protection .....                   | 4-26 |
| 4.4.2   | ACL-Based Protection .....                   | 4-26 |
| 4.5     | Populating a File .....                      | 4-27 |
| 4.5.1   | Using the Convert Utility .....              | 4-27 |
| 4.5.2   | Using the Convert Routines .....             | 4-27 |
| 4.6     | Summary of File-Creation Options .....       | 4-31 |
| 4.6.1   | File-Creation Options .....                  | 4-31 |
| 4.6.2   | File Characteristics .....                   | 4-32 |
| 4.6.3   | File Allocation and Positioning .....        | 4-34 |

## 5 Locating and Naming Files on Disks

|           |   |      |
|-----------|---|------|
| 5.1       | Understanding Disk File Specifications .....                      | 5-1  |
| 5.2       | File Specification Components .....                               | 5-2  |
| 5.2.1     | The Node Component .....  | 5-2  |
| 5.2.1.1   | Local Node .....  | 5-3  |
| 5.2.1.2   | Remote Node .....   | 5-3  |
| 5.2.2     | The Device Component .....  | 5-3  |
| 5.2.3     | On-Disk Components .....  | 5-4  |
| 5.2.3.1   | Character Set for On-Disk Components .....                        | 5-4  |
| 5.2.3.1.1 | Base Character Set .....  | 5-4  |
| 5.2.3.1.2 | Extended Character Set .....                                      | 5-4  |
| 5.2.4     | RMS and On-Disk Representation .....                              | 5-5  |
| 5.2.4.1   | Simple Characters .....   | 5-6  |
| 5.2.4.2   | Compound Characters .....   | 5-6  |
| 5.2.4.3   | Uppercase and Lowercase Letters and Multiple File Versions .....  | 5-7  |
| 5.2.4.4   | Convert System Service .....                                      | 5-8  |
| 5.2.5     | The Root Component .....  | 5-8  |
| 5.2.6     | The Directory Component .....                                     | 5-8  |
| 5.2.7     | The File Name, Type, and Version Components .....                 | 5-9  |
| 5.2.8     | Leading Hyphens in File and Subdirectory Names (Alpha Only) ..... | 5-10 |
| 5.2.9     | Restrictions and Anomalies .....                                  | 5-10 |
| 5.2.9.1   | Restriction with Extended File Names .....                        | 5-10 |
| 5.2.9.2   | DCL Parsing Anomaly .....   | 5-11 |
| 5.3       | Logical Names and Parsing .....                                   | 5-11 |
| 5.4       | File Specification and Component Length Limits .....              | 5-12 |
| 5.4.1     | VAX Systems and ODS-2 Disks on Alpha Systems .....                | 5-12 |
| 5.4.2     | ODS-5 on Alpha Systems .....                                      | 5-13 |
| 5.4.3     | Maximum Subdirectory Depths .....                                 | 5-13 |
| 5.4.4     | Accessing Files on ODS-5 Disks from VAX Systems .....             | 5-14 |
| 5.4.5     | Determining the Structure Level of a Disk Device .....            | 5-14 |
| 5.4.6     | Using File Specification Defaults .....                           | 5-17 |
| 5.5       | Image Activation Using Logical Names .....                        | 5-17 |
| 5.6       | Sample Use of Logical Names .....                                 | 5-17 |
| 5.7       | Types of Logical Names .....                                      | 5-20 |

|       |   |      |
|-------|---|------|
| 5.8   | Introduction to File Parsing . . . . .                      | 5-21 |
| 5.9   | Using One File Specification to Locate Many Files . . . . . | 5-22 |
| 5.9.1 | Processing One File . . . . .                               | 5-27 |
| 5.9.2 | Processing Many Files . . . . .                             | 5-28 |
| 5.9.3 | Processing One or Many Files . . . . .                      | 5-29 |

## 6 Advanced Use of File Specifications

|         |   |      |
|---------|---|------|
| 6.1     | How RMS Applies Defaults . . . . .                                    | 6-1  |
| 6.2     | Understanding RMS Parsing . . . . .                                   | 6-4  |
| 6.2.1   | Checking for Open-by-Name Block . . . . .                             | 6-5  |
| 6.2.2   | File Specification Formats and Translating Logical Names . . . . .    | 6-5  |
| 6.2.3   | Special Parsing Conventions . . . . .                                 | 6-6  |
| 6.2.3.1 | Parsing Conventions for a Search List . . . . .                       | 6-7  |
| 6.2.3.2 | Special Processing for a Related File Specification . . . . .         | 6-8  |
| 6.2.3.3 | Input File Specification Parsing . . . . .                            | 6-9  |
| 6.2.3.4 | Output File Specification Parsing . . . . .                           | 6-10 |
| 6.3     | Directory Syntax Conventions and Directory Concatenation . . . . .    | 6-11 |
| 6.3.1   | Using Normal Directory Syntax . . . . .                               | 6-11 |
| 6.3.2   | Rooted-Directory Syntax Applications . . . . .                        | 6-14 |
| 6.3.3   | Using Rooted-Directory Syntax . . . . .                               | 6-14 |
| 6.3.4   | Concatenating Rooted-Directory Specifications . . . . .               | 6-15 |
| 6.3.5   | An Example of Using a Rooted Directory . . . . .                      | 6-17 |
| 6.3.6   | Using a Rooted Directory to Extend RMS's Subdirectory Limit . . . . . | 6-18 |
| 6.4     | DID-Abbreviated Directories (Alpha Only) . . . . .                    | 6-19 |
| 6.5     | FID-Abbreviated Names (Alpha Only) . . . . .                          | 6-20 |
| 6.5.1   | Restrictions on FID-Abbreviated Names . . . . .                       | 6-21 |
| 6.6     | Using Process-Permanent Files . . . . .                               | 6-21 |

## 7 File Sharing and Buffering

|         |  |      |
|---------|--|------|
| 7.1     | File Accessing . . . . .                                       | 7-1  |
| 7.1.1   | Types of File Sharing and Record Streams . . . . .             | 7-2  |
| 7.1.2   | Interlocked Interprocess File Sharing . . . . .                | 7-5  |
| 7.1.3   | User-Interlocked Interprocess File Sharing . . . . .           | 7-6  |
| 7.2     | Record Locking . . . . .                                       | 7-7  |
| 7.2.1   | Default Record Locking . . . . .                               | 7-8  |
| 7.2.2   | Record-Locking Options . . . . .                               | 7-8  |
| 7.2.2.1 | Exclusive Locking . . . . .                                    | 7-9  |
| 7.2.2.2 | Write Locking . . . . .  | 7-9  |
| 7.2.2.3 | Read Locking . . . . .   | 7-10 |
| 7.2.2.4 | No Locking (Query Locking) . . . . .                           | 7-10 |
| 7.2.2.5 | No Query Record Locking Option (Alpha Only) . . . . .          | 7-10 |
| 7.2.2.6 | Put Service Considerations . . . . .                           | 7-12 |
| 7.2.2.7 | Summary . . . . .  | 7-13 |
| 7.2.3   | Handling Record-Locking Conflicts . . . . .                    | 7-13 |
| 7.2.3.1 | Handling the Record-Locked Error . . . . .                     | 7-14 |
| 7.2.3.2 | Waiting for Locked Records . . . . .                           | 7-15 |
| 7.2.3.3 | Reading Regardless of Lock . . . . .                           | 7-15 |
| 7.2.4   | Miscellaneous Record-Locking Options . . . . .                 | 7-15 |
| 7.2.4.1 | Manual-Unlocking Option . . . . .                              | 7-15 |
| 7.2.4.2 | Lock-Nonexistent-Record Option . . . . .                       | 7-16 |
| 7.2.5   | Record-Locking Deadlocks . . . . .                             | 7-16 |
| 7.2.5.1 | Record Locking Options to Control Deadlock Detection . . . . . | 7-17 |

|         |   |      |
|---------|---|------|
| 7.3     | Local and Shared Buffering Techniques . . . . . | 7-17 |
| 7.3.1   | Record Transfer Modes . . . . .                 | 7-17 |
| 7.3.2   | Understanding Buffering . . . . .               | 7-18 |
| 7.3.3   | Buffering for Sequential Files . . . . .        | 7-20 |
| 7.3.4   | Buffering for Relative Files . . . . .          | 7-20 |
| 7.3.5   | Buffering for Indexed Files . . . . .           | 7-21 |
| 7.3.6   | Using Global Buffers for Shared Files . . . . . | 7-22 |
| 7.3.6.1 | Enhancing Global Buffer Performance . . . . .   | 7-24 |

## 8 Record Processing

|         |  |      |
|---------|--|------|
| 8.1     | Record Operations . . . . .                                | 8-1  |
| 8.2     | Primary Services . . . . .                                 | 8-1  |
| 8.2.1   | Locating and Retrieving Records . . . . .                  | 8-2  |
| 8.2.2   | Inserting Records . . . . .                                | 8-3  |
| 8.2.3   | Updating Records . . . . .                                 | 8-4  |
| 8.2.4   | Deleting Records . . . . .                                 | 8-4  |
| 8.3     | Secondary Services . . . . .                               | 8-5  |
| 8.4     | Record Access for the Various File Organizations . . . . . | 8-5  |
| 8.4.1   | Processing Sequential Files . . . . .                      | 8-7  |
| 8.4.1.1 | Sequential Access . . . . .                                | 8-7  |
| 8.4.1.2 | Random Access . . . . .                                    | 8-7  |
| 8.4.2   | Processing Relative Files . . . . .                        | 8-8  |
| 8.4.2.1 | Sequential Access . . . . .                                | 8-8  |
| 8.4.2.2 | Random Access . . . . .                                    | 8-8  |
| 8.4.3   | Processing Indexed Files . . . . .                         | 8-9  |
| 8.4.3.1 | Sequential Access . . . . .                                | 8-12 |
| 8.4.3.2 | Random Access . . . . .                                    | 8-12 |
| 8.4.4   | Access by Record File Address (RFA) . . . . .              | 8-14 |
| 8.5     | Block Input/Output . . . . .                               | 8-15 |
| 8.6     | Current Record Context . . . . .                           | 8-15 |
| 8.6.1   | Current-Record Position . . . . .                          | 8-16 |
| 8.6.2   | Next-Record Position . . . . .                             | 8-17 |
| 8.7     | Synchronous and Asynchronous Operations . . . . .          | 8-18 |
| 8.7.1   | Using Synchronous Operations . . . . .                     | 8-18 |
| 8.7.2   | Using Asynchronous Operations . . . . .                    | 8-19 |

## 9 Run-Time Options

|         |  |      |
|---------|--|------|
| 9.1     | Specifying Run-Time Options . . . . .                  | 9-1  |
| 9.1.1   | Using the Edit/FDL Utility . . . . .                   | 9-1  |
| 9.1.2   | Using Language Statements and RMS . . . . .            | 9-5  |
| 9.2     | Options Related to Opening and Closing Files . . . . . | 9-5  |
| 9.2.1   | File Access and Sharing Options . . . . .              | 9-6  |
| 9.2.2   | File Specifications . . . . .                          | 9-6  |
| 9.2.3   | File Performance Options . . . . .                     | 9-7  |
| 9.2.3.1 | Extension Size . . . . .                               | 9-7  |
| 9.2.3.2 | Window Size . . . . .                                  | 9-7  |
| 9.2.3.3 | Summary of Performance Options . . . . .               | 9-8  |
| 9.2.4   | Record Access Options . . . . .                        | 9-10 |
| 9.2.5   | Options for Adding Records . . . . .                   | 9-10 |
| 9.2.6   | Options for Data Reliability . . . . .                 | 9-11 |
| 9.2.7   | Options for File Disposition . . . . .                 | 9-11 |
| 9.2.8   | Options for Indexed Files . . . . .                    | 9-12 |

|        |   |      |
|--------|---|------|
| 9.2.9  | Options for Magnetic Tape Processing . . . . .    | 9-13 |
| 9.2.10 | Options for Nonstandard File Processing . . . . . | 9-14 |
| 9.3    | Summary of Record Operation Options . . . . .     | 9-14 |
| 9.3.1  | Record Retrieval Options . . . . .                | 9-15 |
| 9.3.2  | Put Service Options . . . . .                     | 9-18 |
| 9.3.3  | Record Update Options . . . . .                   | 9-20 |
| 9.3.4  | Record Deletion Options . . . . .                 | 9-21 |
| 9.4    | Run-Time Example . . . . .                        | 9-22 |

## 10 Maintaining Files

|        |   |       |
|--------|---|-------|
| 10.1   | Viewing File Characteristics . . . . .                    | 10-1  |
| 10.1.1 | Performing an Error Check . . . . .                       | 10-1  |
| 10.1.2 | Generating a Statistics Report . . . . .                  | 10-6  |
| 10.1.3 | Using Interactive Mode . . . . .                          | 10-11 |
| 10.1.4 | Examining a Sequential File . . . . .                     | 10-12 |
| 10.1.5 | Examining a Relative File . . . . .                       | 10-15 |
| 10.1.6 | Examining an Indexed File . . . . .                       | 10-17 |
| 10.2   | Generating an FDL File from a Data File . . . . .         | 10-22 |
| 10.3   | Optimizing and Redesigning File Characteristics . . . . . | 10-24 |
| 10.3.1 | Redesigning an FDL File . . . . .                         | 10-25 |
| 10.3.2 | Optimizing a Data File . . . . .                          | 10-26 |
| 10.4   | Making a File Contiguous . . . . .                        | 10-27 |
| 10.4.1 | Using the Copy Utility . . . . .                          | 10-27 |
| 10.4.2 | Using the Convert Utility . . . . .                       | 10-28 |
| 10.4.3 | Reclaiming Buckets in Prolog 3 Files . . . . .            | 10-28 |
| 10.5   | Reorganizing a File . . . . .                             | 10-28 |
| 10.6   | Making Archive Copies . . . . .                           | 10-29 |

## A Edit/FDL Utility Optimization Algorithms

|     |                          |     |
|-----|--------------------------|-----|
| A.1 | Allocation . . . . .     | A-1 |
| A.2 | Extension Size . . . . . | A-1 |
| A.3 | Bucket Size . . . . .    | A-1 |
| A.4 | Global Buffers . . . . . | A-2 |
| A.5 | Index Depth . . . . .    | A-2 |

## Glossary

## Index

## Examples

|     |  |      |
|-----|--|------|
| 2-1 | Creating a File Containing Collated Keys . . . . .           | 2-25 |
| 4-1 | Sample Edit/FDL Utility Session . . . . .                    | 4-5  |
| 4-2 | Sample FDL File . . . . .                                    | 4-9  |
| 4-3 | Using FDL Routines in a Pascal Program . . . . .             | 4-14 |
| 4-4 | Using the FDL\$CREATE Routine in a Fortran Program . . . . . | 4-17 |
| 4-5 | Using the FDL\$CREATE Routine from a COBOL Program . . . . . | 4-18 |
| 4-6 | Tagging a File . . . . .                                     | 4-21 |
| 4-7 | Accessing a Tagged File . . . . .                            | 4-24 |
| 4-8 | Using the CONVERT Routines in a Fortran Program . . . . .    | 4-28 |

|      |   |       |
|------|---|-------|
| 4-9  | Using the CONVERT Routines in a COBOL Program . . . . .         | 4-29  |
| 5-1  | Using Logical Names for Remote File Access . . . . .            | 5-19  |
| 5-2  | Selecting the USEROPEN Option to Call a Routine . . . . .       | 5-24  |
| 5-3  | Using the Parse and Search Services . . . . .                   | 5-26  |
| 6-1  | Rooted-Directory Syntax . . . . .                               | 6-18  |
| 7-1  | Designing a Pause Between Attempts to Access a Record . . . . . | 7-14  |
| 9-1  | Specifying Run-Time Attributes . . . . .                        | 9-2   |
| 9-2  | Using the FDL\$PARSE and FDL\$RELEASE Routines . . . . .        | 9-22  |
| 10-1 | Using ANALYZE/RMS_FILE to Create a Check Report . . . . .       | 10-2  |
| 10-2 | Using ANALYZE/RMS_FILE to Create a Statistics Report . . . . .  | 10-6  |
| 10-3 | Examining a Sequential File . . . . .                           | 10-13 |
| 10-4 | Examining a Relative File . . . . .                             | 10-16 |
| 10-5 | Examining an Area Descriptor Path . . . . .                     | 10-18 |
| 10-6 | Examining a Primary Record . . . . .                            | 10-20 |
| 10-7 | Examining an Alternate Record . . . . .                         | 10-22 |
| 10-8 | KEY and ANALYSIS_OF_KEY Sections in an FDL File . . . . .       | 10-23 |

## Figures

|      |  |      |
|------|--|------|
| 1-1  | Files-11 On-Disk Structure Hierarchy . . . . .               | 1-6  |
| 1-2  | Single and Multiple File Extents . . . . .                   | 1-7  |
| 1-3  | Tracks and Cylinders . . . . .                               | 1-13 |
| 1-4  | DSI and FAT Structures in an XAR . . . . .                   | 1-17 |
| 1-5  | Interrecord Gaps . . . . .                                   | 1-19 |
| 1-6  | Basic Layout of an ANSI Magnetic Tape Volume . . . . .       | 1-21 |
| 1-7  | Single File on a Single Volume . . . . .                     | 1-24 |
| 1-8  | Single File on Multiple Tape Volumes . . . . .               | 1-25 |
| 1-9  | Multifile/Single-Volume Configuration . . . . .              | 1-25 |
| 1-10 | Multifile/Multivolume Configuration . . . . .                | 1-26 |
| 1-11 | Blocked Fixed-Length Records . . . . .                       | 1-32 |
| 1-12 | Variable-Length Records . . . . .                            | 1-32 |
| 1-13 | Using CONVERT to Create a Data File . . . . .                | 1-38 |
| 1-14 | Using CREATE/FDL to Create an Empty Data File . . . . .      | 1-39 |
| 2-1  | Sequential Access to a Sequential File . . . . .             | 2-3  |
| 2-2  | Sequentially Retrieving Records in a Relative File . . . . . | 2-4  |
| 2-3  | Sequentially Storing Records in a Relative File . . . . .    | 2-5  |
| 2-4  | Random Access by Relative Record Number . . . . .            | 2-6  |
| 2-5  | Random Access by Record File Address . . . . .               | 2-8  |
| 2-6  | Comparison of Fixed- and Variable-Length Records . . . . .   | 2-11 |
| 2-7  | Writing a VFC Record to a File . . . . .                     | 2-12 |
| 2-8  | Retrieving a VFC Record . . . . .                            | 2-13 |
| 2-9  | Sequential File Organization . . . . .                       | 2-16 |
| 2-10 | Relative File Organization . . . . .                         | 2-17 |
| 2-11 | Variable-Length Records in Fixed-Length Cells . . . . .      | 2-18 |
| 2-12 | Single-Key Indexed File Organization . . . . .               | 2-22 |
| 2-13 | Multiple-Key Indexed File Organization . . . . .             | 2-23 |
| 3-1  | RMS Index Structure . . . . .                                | 3-21 |

|      |   |       |
|------|---|-------|
| 3-2  | Primary Index Structure . . . . .                       | 3-21  |
| 3-3  | Finding the Record with Key 14 . . . . .                | 3-22  |
| 4-1  | Line_Plot Graph . . . . .                               | 4-11  |
| 4-2  | Surface_Plot Graph . . . . .                            | 4-12  |
| 4-3  | Design Mnemonics . . . . .                              | 4-13  |
| 7-1  | Shared File Access . . . . .                            | 7-1   |
| 7-2  | RMS Buffers and the Application Program . . . . .       | 7-19  |
| 7-3  | Using Global Buffers for a Shared File . . . . .        | 7-23  |
| 8-1  | Using RFA Access to Establish Record Position . . . . . | 8-14  |
| 10-1 | Tree Structure for Sequential Files . . . . .           | 10-12 |
| 10-2 | Record Layout and Content for SEQ.DAT . . . . .         | 10-12 |
| 10-3 | Tree Structure of Relative Files . . . . .              | 10-15 |
| 10-4 | Area Descriptor Path . . . . .                          | 10-17 |
| 10-5 | Key Descriptor Path . . . . .                           | 10-19 |
| 10-6 | Structure of Primary Records . . . . .                  | 10-20 |
| 10-7 | Structure of Alternate Records . . . . .                | 10-21 |
| 10-8 | RMS Tuning Cycle . . . . .                              | 10-25 |

## Tables

|      |  |       |
|------|--|-------|
| 1-1  | Record Access Methods . . . . .                                      | 1-2   |
| 1-2  | Record Formats . . . . .   | 1-2   |
| 1-3  | File Structure Options on OpenVMS Systems . . . . .                  | 1-4   |
| 1-4  | Comparison of ODS-1, ODS-2, and ODS-5 Levels . . . . .               | 1-4   |
| 1-5  | Files-11 Control Files . . . . .                                     | 1-8   |
| 1-6  | Labels and Components Supported by OpenVMS Systems . . . . .         | 1-23  |
| 2-1  | Supported Record Access Modes and File Organizations . . . . .       | 2-2   |
| 2-2  | File Organization Characteristics . . . . .                          | 2-14  |
| 2-3  | Sequential File Organization: Advantages and Disadvantages . . . . . | 2-16  |
| 2-4  | Relative File Organization: Advantages and Disadvantages . . . . .   | 2-18  |
| 2-5  | Indexed File Organization: Advantages and Disadvantages . . . . .    | 2-25  |
| 4-1  | Summary of the Edit/FDL Utility Commands . . . . .                   | 4-3   |
| 4-2  | Edit/FDL Utility Scripts . . . . .                                   | 4-4   |
| 6-1  | File Specification Defaults . . . . .                                | 6-2   |
| 6-2  | Example of Applying Defaults . . . . .                               | 6-3   |
| 7-1  | File Access Record Operations . . . . .                              | 7-3   |
| 7-2  | File-Sharing Record Operations . . . . .                             | 7-4   |
| 7-3  | Initial File Sharing and Subsequent File Access . . . . .            | 7-6   |
| 7-4  | Initial File Access and Subsequent File Sharing . . . . .            | 7-6   |
| 7-5  | Methods Available for Specifying No Query Record Locking . . . . .   | 7-12  |
| 7-6  | Compatibility of Record-Locking Options . . . . .                    | 7-13  |
| 8-1  | Record Operations and File Organizations . . . . .                   | 8-2   |
| 8-2  | Search Key Types . . . . .   | 8-9   |
| 8-3  | Record Access Stream Context . . . . .                               | 8-15  |
| 10-1 | ANALYZE/RMS_FILE Command Summary . . . . .                           | 10-11 |



---

# Preface

## Intended Audience

This document is intended for applications programmers and designers who create or maintain application programs that use RMS files.

You may also read this document to gain a general understanding of the file- and record-processing options available on an OpenVMS system.

## Document Structure

This guide contains 10 chapters, one appendix, and a glossary.

- Chapter 1 provides general information on file, disk, and magnetic tape concepts and brief overviews of available media, RMS, FDL, and resource requirements.
- Chapter 2 describes the file organizations and record access modes to help you choose the correct file organization for your application.
- Chapter 3 discusses general performance considerations and specific decisions you can make in the design of your application.
- Chapter 4 describes procedures necessary to create files, populate files with records, and protect files.
- Chapter 5 describes file specifications and the procedures needed to use them.
- Chapter 6 describes the rules of file specification parsing and advanced file specification use. Information about rooted directories is also provided.
- Chapter 7 describes file sharing and buffering, including record locking and the use of global buffers.
- Chapter 8 describes aspects of record processing, including record access modes; synchronous and asynchronous record operations; and retrieving, inserting, updating, and deleting records.
- Chapter 9 describes how to specify run-time options and summarizes the run-time options available when a file is opened and closed and when records are retrieved, inserted, updated, and deleted.
- Chapter 10 describes procedures needed to maintain properly tuned files, with the emphasis on efficiently maintaining indexed files.
- Appendix A describes the algorithms used by the Edit/FDL utility.
- The Glossary provides definitions of terms that are commonly used in this guide.

## Associated Documents

The reader should be familiar with the information in the following documents:

- The *OpenVMS User's Manual* describes the use of the operating system for a general audience.
- Programmers should be familiar with the appropriate documentation for the high-level language in which the application will be written.
- System managers should be familiar with the *OpenVMS System Manager's Manual*, a task-oriented guide to managing an OpenVMS system.

## Related Documents

For additional information about Compaq *OpenVMS* products and services, access the Compaq website at the following location:

<http://www.openvms.compaq.com/>

## Reader's Comments

Compaq welcomes your comments on this manual. Please send comments to either of the following addresses:

|          |  |
|----------|--|
| Internet | <b>openvmsdoc@compaq.com</b>   |
| Mail     | Compaq Computer Corporation<br>OSSG Documentation Group, ZKO3-4/U08<br>110 Spit Brook Rd.<br>Nashua, NH 03062-2698 |

## How To Order Additional Documentation

Visit the following World Wide Web address for information about how to order additional documentation:

<http://www.openvms.compaq.com/>

## Conventions

In this manual, every use of DECwindows and DECwindows Motif refers to DECwindows Motif for OpenVMS software.

The following conventions are also used in this manual:

|                |   |
|----------------|---|
| Ctrl/ <i>x</i> | A sequence such as Ctrl/ <i>x</i> indicates that you must hold down the key labeled Ctrl while you press another key or a pointing device button.                       |
| PF1 <i>x</i>   | A sequence such as PF1 <i>x</i> indicates that you must first press and release the key labeled PF1 and then press and release another key or a pointing device button. |
| PF1 <i>x</i>   | A sequence such as PF1 <i>x</i> indicates that you must first press and release the key labeled PF1 and then press and release another key or a pointing device button. |

`Return`

In examples, a key name enclosed in a box indicates that you press a key on the keyboard. (In text, a key name is not enclosed in a box.)

In the HTML version of this document, this convention appears as brackets, rather than a box.

...

A horizontal ellipsis in examples indicates one of the following possibilities:

- Additional optional arguments in a statement have been omitted.
- The preceding item or items can be repeated one or more times.
- Additional parameters, values, or other information can be entered.

.

A vertical ellipsis indicates the omission of items from a code example or command format; the items are omitted because they are not important to the topic being discussed.

( )

In command format descriptions, parentheses indicate that you must enclose choices in parentheses if you specify more than one.

[ ]

In command format descriptions, brackets indicate optional choices. You can choose one or more items or no items. Do not type the brackets on the command line. However, you must include the brackets in the syntax for OpenVMS directory specifications and for a substring specification in an assignment statement.

|

In command format descriptions, vertical bars separate choices within brackets or braces. Within brackets, the choices are optional; within braces, at least one choice is required. Do not type the vertical bars on the command line.

{ }

In command format descriptions, braces indicate required choices; you must choose at least one of the items listed. Do not type the braces on the command line.

**bold text**

This typeface represents the introduction of a new term. It also represents the name of an argument, an attribute, or a reason.

*italic text*

Italic text indicates important information, complete titles of manuals, or variables. Variables include information that varies in system output (Internal error *number*), in command lines (*/PRODUCER=name*), and in command parameters in text (where *dd* represents the predefined code for the device type).

UPPERCASE TEXT

Uppercase text indicates a command, the name of a routine, the name of a file, or the abbreviation for a system privilege.

Monospace text

Monospace type indicates code examples and interactive screen displays.

In the C programming language, monospace type in text identifies the following elements: keywords, the names of independently compiled external functions and files, syntax summaries, and references to variables or identifiers introduced in an example.

-

A hyphen at the end of a command format description, command line, or code line indicates that the command or statement continues on the following line.

numbers

All numbers in text are assumed to be decimal unless otherwise noted. Nondecimal radices—binary, octal, or hexadecimal—are explicitly indicated.

---

# Introduction

This chapter illustrates how basic data management concepts are applied by the OpenVMS Record Management Services (OpenVMS RMS), referred to hereafter as RMS. RMS is the data management subsystem of the operating system. In combination with OpenVMS operating systems, RMS allows efficient and flexible storage, retrieval, and modification of data on disks, magnetic tapes, and other devices. RMS may be implemented through the File Definition Language (FDL) interface or through high-level language, program-specific processing options. Although RMS supports devices such as line printers, terminals, and card readers, the purpose of this guide is to introduce you to RMS record keeping on magnetic tape and disk.

In contrast to magnetic tape storage, disk storage allows faster data access while providing the same virtually limitless storage capacity. Disks provide faster access because the computer can locate files and records selectively without first searching through intervening data. This faster access time makes disks the most appropriate medium for online file processing applications.

## 1.1 File Concepts

The following file concepts are discussed in this manual:

- Files
- Records
- Fields
- Bytes and bits
- Access modes
- Record formats
- Maximum RMS file size

A computer file is an organized collection of data stored on a mass storage volume and processed by a central processing unit (CPU). Data files are organized to accommodate the processing of data within the file by an application program. The basic unit of electronic data processing is the *record*. A record is a collection of related data that the application program processes as a functional entity. For example, all the information about an employee, such as name, street address, city, and state, constitutes a personnel record. Records are made up of *fields*, which are sets of contiguous bytes. For example, a person's name or address might be a field. A *byte* is a group of binary digits (bits) that are used to represent a single character. You can also think of a field or an item as a group of bytes in a record that are related in some way.

## Introduction

### 1.1 File Concepts

The records in a file must be formatted uniformly. That is, they must conform to some defined arrangement of the record fields including the field length, field location, and the field data type (character strings or binary integers, for instance). To process file data, an application must know the arrangement of the record fields, especially if the application intends to modify existing records or to add new records to the file.

The *file organization* is the manner in which data is recorded within a file, typically using either fixed-length or variable-length records. The file organization, together with the applicable storage medium, determines what techniques are used to access data. Currently, RMS supports two methods of record access: *sequential access* and *direct access*. Direct access includes relative access (using the relative position of a record) and indexed access (using an indexing key within the record). See Table 1–1 for more information about record access methods.

**Table 1–1 Record Access Methods**

| Access Method                 | Description  |
|-------------------------------|--|
| Sequential Access             | Records are stored or retrieved one after another starting at a particular point in the file and continuing in order through the file.   |
| Relative Record Number Access | Records are stored and retrieved by relative record number or by file address. Records occupy cells of equal length, and each cell is assigned a <b>relative record number</b> , which represents the cell's position relative to the beginning of the file. |
| Record File Address Access    | When a record is accessed directly by its file address, the distinction is made by its unique location in the file; that is, its <b>record file address (RFA)</b> .  |
| Indexed Access                | Indexed file records are stored and retrieved by a <b>key</b> in the data record. The desired records are usually accessed directly and then retrieved sequentially in sorted order using a key embedded in the record.                                      |

The *record format* refers to the way all records in a file appear physically on the recording surface of the storage medium and is defined in terms of record length. Table 1–2 describes the four record formats supported by RMS.

**Table 1–2 Record Formats**

| Record Format                                    | Description  |
|--|--|
| Fixed length                                     | All records are the same length.   |
| Variable length                                  | Records vary in length. Each record is prefixed with a count byte that contains the number of bytes in the record. The count byte may be either MSB- or LSB-formatted. |
| Variable record length with fixed-length control | Records do not have to be the same length, but each includes a fixed-length control field that precedes the variable-length data portion.                              |

(continued on next page)

**Table 1–2 (Cont.) Record Formats**

| Record Format | Description   |
|---------------|---|
| Stream        | Records are delimited by special characters or character sequences called <i>terminators</i> . Records with stream format are interpreted as a continuous sequence, or stream, of bytes. The carriage return and the line feed characters are commonly used as terminators. |

When you design a file, you specify the file storage medium and the file and record characteristics directly through your application program or indirectly using an appropriate utility. Chapter 2 outlines RMS file organization, record access modes, and record characteristics in detail.

After RMS creates the file, the application program must consider these record characteristics when storing, retrieving, and modifying records. See Chapter 4 for information about creating files, populating files with records, and protecting files. See Chapter 8 for information about record processing, including record access modes; synchronous and asynchronous record operations; and retrieving, inserting, updating, and deleting records.

The maximum size of an RMS file has no built-in limitation other than the 32-bit virtual block number (VBN). In terms of blocks, a single file is limited to a VBN that must be described in 32 bits. So the maximum size of an RMS file is about 4.2 billion (4,294,967,295) blocks. In terms of bytes, this is equivalent to 2 terabytes.

## 1.2 Disk Concepts

This section describes disk concepts as an aid to understanding how a disk may be configured to enhance data access for improved performance. Disk structures may be defined as either logical or physical and the two types interact with each other to some degree. That is, you cannot manipulate a logical structure without considering the effect on a corresponding physical structure.

RMS disk files reside on *Files–11 On-Disk Structure* (ODS) disks. Files–11 is the name of the disk structures supported by the operating system. Files–11 disk structures are further characterized as being either on-disk structures or CD–ROM volume and file structures. The Files–11 structure is a hierarchical organization of files, their data, and the directories needed to gain access to them. The OpenVMS file system implements the Files–11 on-disk structure and provides random access to the files located on the disk or CD-ROM. Users can read from and write to disks. Users can read from and write to disks. They can read from CD-ROMs and if they have a CD-Recordable (CD-R or CD-RW) drive, they can write (or burn) their own CD-ROMs.

On-disk structures include levels 1, 2, and 5. (Levels 3 and 4 are internal names for ISO and High Sierra CD formats.) ODS-1 and ODS-2 structures have been available on OpenVMS systems for some time. Beginning with OpenVMS Version 7.2 on Alpha systems, you can also specify ODS-5 to format disks.

Table 1–3 compares the characteristics of file structures that are available on OpenVMS Version 7.2 and later systems.

## Introduction

### 1.2 Disk Concepts

**Table 1–3 File Structure Options on OpenVMS Systems**

| Structure   | Disk or CD | Description   |
|-------------|------------|---|
| ODS-1       | Both       | VAX only; use for RSX compatibility: RSX–11M, RSX–11D, RSX–11M–PLUS, and IAS operating systems.   |
| ODS-2       | Both       | Default disk structure of the OpenVMS operating system; use to share data between VAX and Alpha with full compatibility.  |
| ODS-5       | Both       | Alpha only <sup>1</sup> ; superset of ODS-2; use when working with systems like NT that need expanded character sets or directories deeper than ODS-2.  |
| ISO 9660 CD | CD         | ISO format files: read by systems that do not have ODS-2 capability such as PCs, NT systems, and Macintoshes.   |
| Dual format | CD         | Single volume with both ISO 9660 CD and Files-11 CD formats. Files are accessible to both formats whose directories might point to the same data.   |
| Foreign     | Both       | A structure that is not related to a Files–11 structure. When you specify a foreign structure, you make the contents of a volume known to the system, but the system makes no assumptions about its file structure. The application is responsible for supplying a structure. |

<sup>1</sup>You can mount ODS-5-enabled volumes on VAX systems, but you cannot access ODS-5-specific features on a VAX system.

Table 1–4 compares the specific characteristics of Files–11 On-Disk Structure (ODS) levels 1, 2, and 5.

**Table 1–4 Comparison of ODS-1, ODS-2, and ODS-5 Levels**

| Characteristic | ODS-1 (VAX only)   | ODS-2  | ODS-5  |
|----------------|--|--|--|
| File names     | 9.3  | 39.39  | 238 bytes, including the dot. For Unicode, that is 119 characters including the dot. |
| Character set  | Uppercase alphanumeric   | Uppercase alphanumeric plus hyphen (-), dollar sign (\$), and underscore ( ) | ISO Latin-1, Unicode.  |
| File versions  | 32,767 limit; version limits are not supported   | 32,767 limit; version limits are supported                                   | 32,767 limit; version limits are supported   |
| Directories    | No hierarchies of directories and subdirectories; directory entries are not ordered <sup>1</sup> | Alpha: 255 <sup>2</sup><br>VAX: 8 (with rooted logical, 16)                  | Alpha: 255<br>VAX: 8 (with rooted logical, 16).                                      |
| System disk    | Cannot be an ODS-1 volume  | Can be an ODS-2 volume   | Cannot be an ODS-5 volume.   |

<sup>1</sup>RSX–11M, RSX–11D, RSX–11M–PLUS, and IAS systems do not support subdirectories and alphabetical directory entries.

<sup>2</sup>Prior to OpenVMS Version 7.2, RMS limited directory levels to 8 or 16.

(continued on next page)

**Table 1–4 (Cont.) Comparison of ODS-1, ODS-2, and ODS-5 Levels**

| Characteristic   | ODS-1 (VAX only)   | ODS-2  | ODS-5   |
|--|--|--|---|
| OpenVMS Cluster access   | Local access only; files cannot be shared across a cluster                     | Files can be shared across a cluster   | Files can be shared across a cluster. However, only computers running OpenVMS Version 7.2–EFT1 or later can mount ODS-5 disks. VAX computers running Version 7.2–EFT1 or later can see only files with ODS-2 style names. |
| Disk   | Unprotected objects  | Protected objects  | Protected objects.  |
| Disk quotas  | Not supported  | Supported  | Supported.  |
| Multivolume files and volume sets                                | Not supported  | Supported  | Supported.  |
| Placement control  | Not supported  | Supported  | Supported   |
| Caches   | No caching of file header blocks, file identification slots, or extent entries | Caching of file header blocks, file identification slots, and extent entries | Caching of file header blocks, file identification slots, and extent entries.   |
| Clustered allocation   | Not supported  | Supported  | Supported.  |
| Backup home block  | Not supported  | Supported  | Supported.  |
| Protection code E  | E means “extend” for the RSX–11M operating system but is ignored by OpenVMS    | E means “execute access”   | E means “execute access”.   |
| Enhanced protection features (for example, access control lists) | Not supported  | Enhanced protection features supported                                       | Enhanced protection features supported.   |
| RMS journaling   | Not supported  | Supported  | Supported.  |

**Note**

Future enhancements to OpenVMS software will be based primarily on structure levels 2 and 5; therefore, structure level 1 volumes might be further restricted in the future. However, Compaq does not intend for ODS-5 to become the default OpenVMS file structure. The principal use of ODS-5 will be when OpenVMS is a server for other systems (such as Windows NT) that have extended file names.

The default disk structure is Files–11 ODS-2. VAX systems also support Files–11 ODS-1 from earlier operating systems <sup>1</sup> to ensure compatibility among systems.

<sup>1</sup> Earlier operating systems include the RSX–11M, RSX–11D, RSX–11M–PLUS, and Micro/RSX systems.

# Introduction

## 1.2 Disk Concepts

### 1.2.1 Files–11 On-Disk Structure Concepts

The term *Files–11 On-Disk Structure*, or simply ODS, refers to the logical structure given to magnetic disks; namely, a hierarchical organization of files, their data, and the directories needed to gain access to them. The file system implements Files–11 ODS-1 (on VAX systems only) and Files–11 ODS-2 (on VAX and Alpha systems) to define the disk structure and to provide access to the files located on magnetic disks.

This section describes the Files–11 ODS levels and defines related terminology.

See Section 1.2.5 for information about concepts and logical structures used with CD-ROMs formatted in accordance with ISO 9660.

The primary difference between Files–11 ODS-1 and Files–11 ODS-2 is that Files–11 ODS-2 incorporates control capabilities that permit added features including volume sets (described later).

The logical ordering of ODS structures is listed below in order of ascending hierarchy:

- Blocks
- Clusters
- Extents
- Files
- Volumes
- Volume Sets

Figure 1–1 shows the hierarchy of blocks, clusters, extents, and files in the Files–11 ODS.

**Figure 1–1 Files–11 On-Disk Structure Hierarchy**

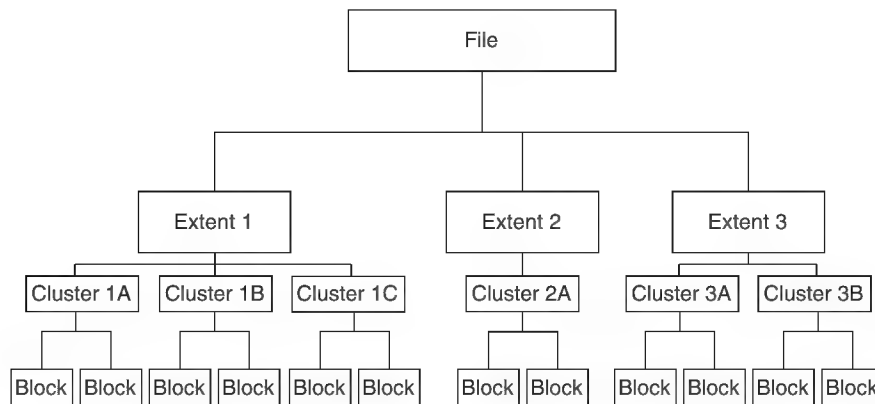

ZK-0739-GE

The next higher level of Files–11 ODS is the *volume* (not illustrated), which is the ordered set of blocks that comprise a disk. However, a volume may include several disks that together make up a structure called a *volume set*. Because

a volume set consists of two or more related volumes, the system treats it as a single volume.

---

**Note**

---

The terms *disk* and *volume* are used interchangeably in this document.

---

The smallest addressable logical structure on a Files-11 ODS disk is a *block*, comprising 512, 8-bit bytes. During input/output operations, one or more blocks may be transferred as a single unit between a Files-11 ODS disk and memory.

RMS allocates disk space for new files or extended files using multiblock units called *clusters*. The system manager specifies the number of blocks in a cluster as part of volume initialization.

Clusters may or may not be contiguous (share a common boundary) on a disk. Cluster sizes may range from 1 to 65,535 blocks. Generally, a system manager assigns a small cluster size to a disk with a relatively small number of blocks. Relatively larger disks are assigned a larger cluster size to minimize the overhead for disk space allocation.

An *extent* is one or more adjacent clusters allocated to a file or to a portion of a file. If enough contiguous disk space is available, the entire file is allocated as a single extent. Conversely, if there is not enough contiguous disk space, the file is allocated using several extents, which may be scattered physically on the disk. Figure 1-2 shows how a single file (File A) may be stored as a single extent or as multiple extents.

**Figure 1-2 Single and Multiple File Extents**

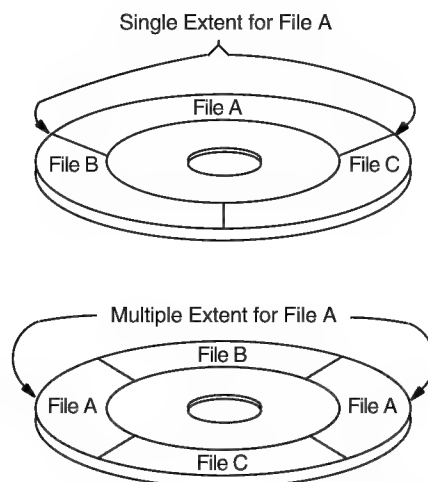

ZK-0738-GE

## Introduction

### 1.2 Disk Concepts

With RMS, you can exercise varying degrees of control over file space allocation. At one extreme, you can specify the number of blocks to be allocated and their precise location on the volume. At the other extreme, you can allow RMS to handle all disk space allocation automatically. As a compromise, you might specify the size of the initial space allocation and have RMS determine the amount of space allocated each time the file is extended. You can also specify that unused space at the end of the file is to be deallocated from the file, making that space available to other files on the volume.

When you need a large amount of file storage space, you can combine several Files-11 ODS volumes into a *volume set* with file extents located on different volumes in the set. You need not specify a particular volume in the set to locate or create a file, but you may improve performance if you explicitly specify a volume for a particular allocation request.

#### 1.2.2 Files-11 Control Files

Ten files control the structure of a Files-11 On-Disk Structure Level 2 volume. Only five of these files are used for a Files-11 On-Disk Structure Level 1 volume. Table 1-5 identifies all nine files, which are referred to as reserved files, and indicates to which Files-11 On-Disk Structure level they pertain.

**Table 1-5 Files-11 Control Files**

| Reserved File         | File Name    | Structure Level 1 | Structure Level 2 |
|-----------------------|--------------|-------------------|-------------------|
| Index file            | INDEXF.SYS;1 | X                 | X                 |
| Storage bit map file  | BITMAP.SYS;1 | X                 | X                 |
| Bad block file        | BADBLK.SYS;1 | X                 | X                 |
| Master file directory | 000000.DIR;1 | X                 | X                 |
| Core image file       | CORIMG.SYS;1 | X                 | X                 |
| Volume set list file  | VOLSET.SYS;1 |                   | X                 |
| Continuation file     | CONTIN.SYS;1 |                   | X                 |
| Backup log file       | BACKUP.SYS;1 |                   | X                 |
| Pending bad block     | BADLOG.SYS;1 |                   | X                 |
| Security profile      | SECURITY.SYS |                   | X                 |

All the files listed in Table 1-5 are listed in the master file directory (MFD), [000000].

##### 1.2.2.1 Index File

Every Files-11 volume has an index file, which is created when the volume is initialized. This index file identifies the volume to the operating system as a Files-11 structure and contains the access data for all files on the volume. The index file, which is listed in the master file directory as INDEXF.SYS;1, contains the following information:

- **Bootstrap block** — The volume's bootstrap block is virtual block number 1 of the index file. If the volume is a system volume, this block contains a bootstrap program that loads the operating system into memory. If the volume is not a system volume, this block contains a program that displays the message that the volume is not the system device but a device that contains user files only.

- Home block — The home block provides specific information about the volume, including default file values. The following information is included within the home block:
  - The volume name
  - Information to locate the remainder of the index file
  - The maximum number of files that can be present on the volume at any given time
  - The user identification code (UIC) of the volume owner
  - Volume protection information (specifies which users can read and/or write the entire volume)

The home block identifies the disk as a Files–11 ODS volume. Initially, the home block is the second block on the volume. Files–11 ODS volumes contain several copies of the home block to ensure that accidental destruction of this information does not affect the ability to locate other files on the volume. If the current home block becomes corrupted, the system selects an alternate home block.

- Alternate home block — The alternate home block is a copy of the home block. It permits the volume to be used even if the primary home block is destroyed.
- Alternate index file header — The alternate index file header permits recovery of data on the volume if the primary index file header becomes damaged.
- Index file bit map — The index file bit map controls the allocation of file headers and thus the number of files on the volume. The bit map contains a bit for each file header allowed on the volume. If the value of a bit for a given file header is 0, a file can be created with this file header. If the value is 1, the file header is already in use.
- File headers — The largest part of the index file is made up of file headers. Each file on the volume has a file header, which describes such properties of the file as file ownership, creation date, and time. Each file header also contains a list of the extents that define the physical location of the file. When a file has many extents, it may be necessary to have multiple file headers for locating them. When this occurs, each header is assigned a file identifier number to associate it with the appropriate file.

When you create a file, you normally specify a name that RMS assigns to the file on a Files–11 ODS volume. RMS places the file name and file identifier associated with the newly created file in a directory that contains an entry defining the location for each file. To subsequently access the file, you specify its name. The system uses the name to define a path through the directory entry to the file identifier. In turn, the file identifier points to the file header that lists the file's extents.

### **1.2.2.2 Storage Bit Map File**

The storage bit map file controls the available space on a volume; this file is listed in the master file directory as BITMAP.SYS;1. It contains a storage control block, which consists of summary information intended to optimize the Files–11 space allocation, and the bit map itself, which lists the availability of individual blocks.

## Introduction

### 1.2 Disk Concepts

#### 1.2.2.3 Bad Block File

The bad block file, which is listed in the master file directory as BADBLK.SYS;1, contains all the bad blocks on the volume. The system detects bad disk blocks dynamically and prevents their reuse once the files to which they are allocated have been deleted.

#### 1.2.2.4 Master File Directory

The master file directory (MFD) itself is listed in the MFD as 000000.DIR;1. The MFD, which is the root of the volume's directory structure, lists the reserved files that control the volume structure and may list both users' files and users' file directories. Usually the MFD is used to list the reserved files and users' file directories; users seldom enter files in the MFD, even on private volumes. In fact, on a private volume, it is most convenient for a user to create a directory that has the same name as the user's default directory on a system disk.

---

#### Note

---

Wildcard directory searches in the MFD always start after 000000.DIR to prevent recursive looping. Therefore, you should avoid creating any directories in the MFD that lexically precede "000000".

---

When the Backup utility (BACKUP) creates sequential disk save sets, it stores the save set file in the MFD.

For an explanation of user file directories and file specifications, see the *OpenVMS User's Manual*.

#### 1.2.2.5 Core Image File

The core image file is listed in the MFD as CORIMG.SYS;1. It is not supported by the operating system.

#### 1.2.2.6 Volume Set List File

The volume set list file is listed in the MFD as VOLSET.SYS;1. This file is used only on relative volume 1 of a volume set. The file contains a list of the labels of all the volumes in the set and the name of the volume set.

#### 1.2.2.7 Continuation File

The continuation file is listed in the MFD as CONTIN.SYS;1. This file is used as the extension file identifier when a file crosses from one volume to another volume of a loosely coupled volume set. This file is used for all but the first volume of a sequential disk save set.

#### 1.2.2.8 Backup Log File

The backup log file is listed in the MFD as BACKUP.SYS;1. This file is reserved for future use.

#### 1.2.2.9 Pending Bad Block Log File

The pending bad block log file is listed in the MFD as BADLOG.SYS;1. This file contains a list of suspected bad blocks on the volume that are not listed in the bad block file.

#### 1.2.2.10 Security Profiles File (VAX Only)

This file contains the volume security profile and is managed with the SET/SHOW security commands.

### 1.2.3 Files–11 On–Disk Structure Level 1 Versus Structure Level 2

For reasons of performance and reliability, Files–11 On–Disk structure level 2, a compatible superset of structure level 1, is the preferred disk structure on an OpenVMS system.

At volume initialization time (see the INITIALIZE command in the *OpenVMS DCL Dictionary*), structure level 2 is the default.

On VAX systems, structure level 1 should be specified only for volumes that must be transportable to RSX–11M, RSX–11D, RSX–11M–PLUS, and IAS systems, as these systems support only that structure level. Additionally, you may be required to handle structure level 1 volumes transported to OpenVMS systems from one of the previously mentioned systems.

Structure level 1 volumes have the following limitations:

- Directories — No hierarchies of directories and subdirectories, and no ordering of directory entries (that is, the file names) in any way. RSX–11M, RSX–11D, RSX–11M–PLUS, and IAS systems do not support subdirectories and alphabetical directory entries.
- Disk quotas — Not supported.
- Multivolume files and volume sets — Not supported.
- Placement control — Not supported.
- Caches — No caching of file header blocks, file identification slots, or extent entries.
- System disk — Cannot be a structure level 1 volume.
- OpenVMS Cluster access — Local access only; cannot be shared across an OpenVMS Cluster.

---

**Note**

---

In this document, discussions that refer to OpenVMS Cluster environments apply to both VAXcluster systems that include only VAX nodes and OpenVMS Cluster systems that include at least one Alpha node unless indicated otherwise.

---

- Clustered allocation — Not supported.
- Backup home block — Not supported.
- Protection code E — Means extend for the RSX–11M operating system but is ignored by OpenVMS systems.
- File versions — Limited to 32,767; version limits are not supported.
- Enhanced protection features (for example, access control lists) — not supported.
- Extended File Specifications— Not supported.
- RMS journaling for OpenVMS — Not supported.

## Introduction

### 1.2 Disk Concepts

- RMS execution statistics monitoring — Not supported.

#### 1.2.4 Physical Structures

For performance reasons, you should be aware of certain physical aspects of a disk.

A disk (or volume) consists of one or more **platters** that spin at very high, constant speeds and usually contain data on both surfaces (upper and lower). A *disk pack* is made up of two or more platters having a common center.

Data is located at different distances from the center of the platter and is stored or retrieved using read/write heads that move to access data at various radii from the platter's center. The time required to position the read/write heads over the selected radius (referred to as a **track**) is called **seek time**. Each track is divided into 512-byte structures called *sectors*. The time required to bring the selected sector (logical block) under the read/write heads at the selected radius (track) is called the **rotational latency**. Because seek time usually exceeds the rotational latency by a factor of 2 to 4, related blocks (sectors) should be located at or near the same track to obtain the best performance when transferring data between the disk and RMS-maintained buffers in memory. Typically, related blocks of data might include the contents of a file or several files that are accessed together by a performance-critical application.

Another physical disk structure is called a **cylinder**. A cylinder consists of all tracks at the same radius on all recording surfaces of a disk.

Figure 1–3 illustrates the relationship between tracks and cylinders.

Figure 1-3 Tracks and Cylinders

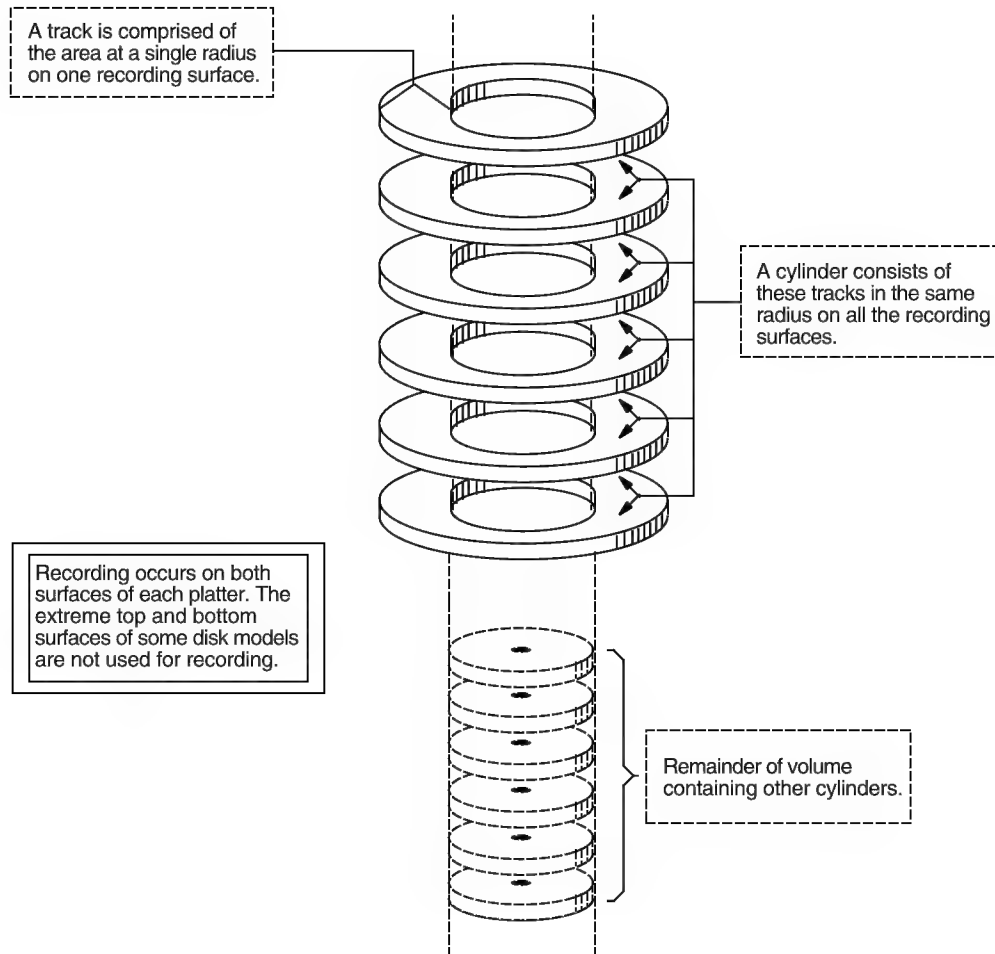

ZK-0740-GE

Because all blocks in a cylinder can be accessed without moving the disk's read and write heads, it is generally advantageous to keep related blocks in the same cylinder. For this reason, when choosing a cluster size for a large-capacity disk, a system manager should consider one that divides evenly into the cylinder size.

## Introduction

### 1.2 Disk Concepts

#### 1.2.5 CD-ROM Concepts

This section describes software support for accessing CD-ROM media in compliance with the ISO 9660 standard. *Compact Disc Read Only Memory* (CD-ROM) discs and CD-ROM readers used with computers are very similar to the CD-ROMs and CD-ROM readers used for audio applications and may incorporate the same hardware. The major difference is that CD-ROM disc readers used with computers have a digital interface that incorporates circuitry which provides error detection and correction logic to improve the accuracy of the disc data.

CD-ROMs provide the following advantages when used to store data:

- Direct access of data allowed.
- Typically less expensive than other direct-access media.
- Large storage capability. Currently, you can store approximately 650 megabytes (1.27 million blocks) of data on a CD-ROM.
- Easier to store and handle off line.

##### 1.2.5.1 CD-ROM On-Disc Formats

CD-ROM media may be formatted according to one or more media formats to incorporate a volume and file structure that is compatible with OpenVMS file system processing. OpenVMS supports CD-ROM access based on the following media formats:

- Files-11 ODS-2—OpenVMS On Disk Structure, Level 2
- ISO 9660—A volume and file structure standard for information interchange on CD-ROMs
- High Sierra—Working paper of the CD-ROM Advisory Committee

##### 1.2.5.2 Volume Structure

CD-ROM media is divided into **logical sectors** that are assigned a unique logical sector number. Logical sectors are the smallest addressable units of a CD-ROM. Each logical sector consists of one or more consecutively ascending physical sectors as defined by the relevant recording standard.<sup>2</sup> Logical sectors are numbered in ascending order. The value 0 is assigned to the logical sector with the lowest physical address containing recorded data. Each logical sector includes a data field made up of at least 2048 bytes—but, in all cases, the number must be a power of 2.

ISO 9660-formatted CD-ROM volumes include a **system area** and a **data area**. The reserved system area includes logical sectors 0 through 15. The data area includes the remaining logical sectors and is called **volume space**. Volume space is organized into **logical blocks** that are numbered in consecutively ascending **logical block number** order.

Logical blocks are made up of at least 512 bytes—but, in all cases, the number of bytes must be a power of 2. However, no logical block can be larger than a logical sector.

---

<sup>2</sup> ISO 10149—Data Interchange on read-only 120mm Optical Discs (CD-ROM), the *Yellow Book*.

The data area may include one or more *Volume Descriptors*, *File Descriptors*, *Directory Descriptors*, and *Path Tables*. These entities collectively describe the volume and file structure of an ISO 9660-formatted CD-ROM. The Ancillary Control Process (ACP) that manages I/O access to the CD-ROM views the volume and file structure as an integral part of the base OpenVMS file system.

### 1.2.5.3 Files-11 C/D—ACPs

The Files-11 C/D implementations allow OpenVMS systems to conform to the ISO 9660 standard at *implementation level 2* and *interchange level 3*. This section describes how Files-11 C/D resolves incompatibilities between the OpenVMS file system and the ISO 9660 standard. The incompatibilities include the following:

- The ISO 9660 requirement for handling blocks that exceed 512 bytes
- Partial extents
- Interleaved data
- Undefined record formats

#### Logical Blocks Greater Than 512 Bytes

OpenVMS device drivers are designed to handle files made up of 512-byte blocks that are uniquely addressable. The ISO 9660 standard supports logical blocks that are greater than 512-bytes. The Files-11 C/D ACP solves this incompatibility by converting ISO 9660 logical-block-size requests into OpenVMS-block-size requests at the file system level.

#### Partial Data Blocks

Any logical block in an ISO 9660 file extent may be partially filled with data. RMS assumes that *all* file blocks are filled with data, with the possible exception of the final block. When RMS finds a data block that is not filled, it attempts to start end-of-file processing. To prevent RMS from misinterpreting a partially-filled block as the final file block, the Files-11 C/D ACP uses I/O operations that combine adjacent ISO 9660 logical blocks into full 512-byte logical blocks.

#### Interleaving

Interleaving is used to gain efficiency in accessing information by storing sequential information on separate tracks. The OpenVMS file system is not natively compatible with interleaving, but ISO 9660 file extents may be interleaved. That is, ISO 9660 extents may consist of logical block groupings that are separated by interleaving gaps. In order to make the OpenVMS file system compatible with interleaving, the Files-11 C/D ACP treats each of the interleaved logical block groups as an extent.

#### Undefined Record Format

ISO 9660 CD-ROMs may be mastered without a specified record format because the ISO 9660 media can be mastered from platforms that do not support the semantics of files containing predefined record formats. See the *OpenVMS System Manager's Manual* for details about mounting media with undefined record formats.

## Introduction

### 1.2 Disk Concepts

#### 1.2.5.4 Using DIGITAL System Identifiers on CD-ROM

When an ISO 9660-formatted CD-ROM contains information written according to Compaq specifications, affected records may include a DIGITAL System Identifier (DSI) in the associated *extended attribute records* (XAR). This section describes how DIGITAL System Identifiers are recorded on ISO 9660 media and how a DSI is used to encode OpenVMS formatted information on the media. Figure 1-4 illustrates the DSI and FAT structures in an XAR.

On ISO 9660 media, XARs include fields for specifying a system identifier in byte positions 85 to 116 (see (A), Figure 1-4.) Immediately preceding the DSI structure, the XAR contains three fields containing record information. If the area immediately following the DSI contains OpenVMS file and record information, you should insert nulls in the record information fields immediately preceding the DSI. The following three fields contain record information:

- Record format in byte position 79
- Record attributes in byte position 80
- Record length in byte positions 81 to 84

If the DSI file identifier field (DSI\$FILE\_SYSTEM\_IDENTIFIER) contains a 0 and the DSI file version field (DSI\$FILE\_SYSTEM\_VERSION) contains either a 1 or a 2, use the area immediately following the DSI to obtain OpenVMS file and record information (See (B), Figure 1-4.)

If the DSI file version field contains a 1, the area immediately following the DSI contains a binary, hex-encoded, file attributes block that provides file and record information. (See (C), Figure 1-4.)

If the DSI file version field contains a 2, the area immediately following the DSI contains an ASCII, hex-encoded, byte stream that provides file and record information. (See (D) in Figure 1-4.)

When the DSI file version field contains a 0, the area immediately following the DSI will not contain file and record information. Nevertheless, if the media is mounted for DSI protection, the OpenVMS UIC codes and permission codes for system, owner, group, and world (SOGW) users will be enforced.

Figure 1-4 DSI and FAT Structures in an XAR

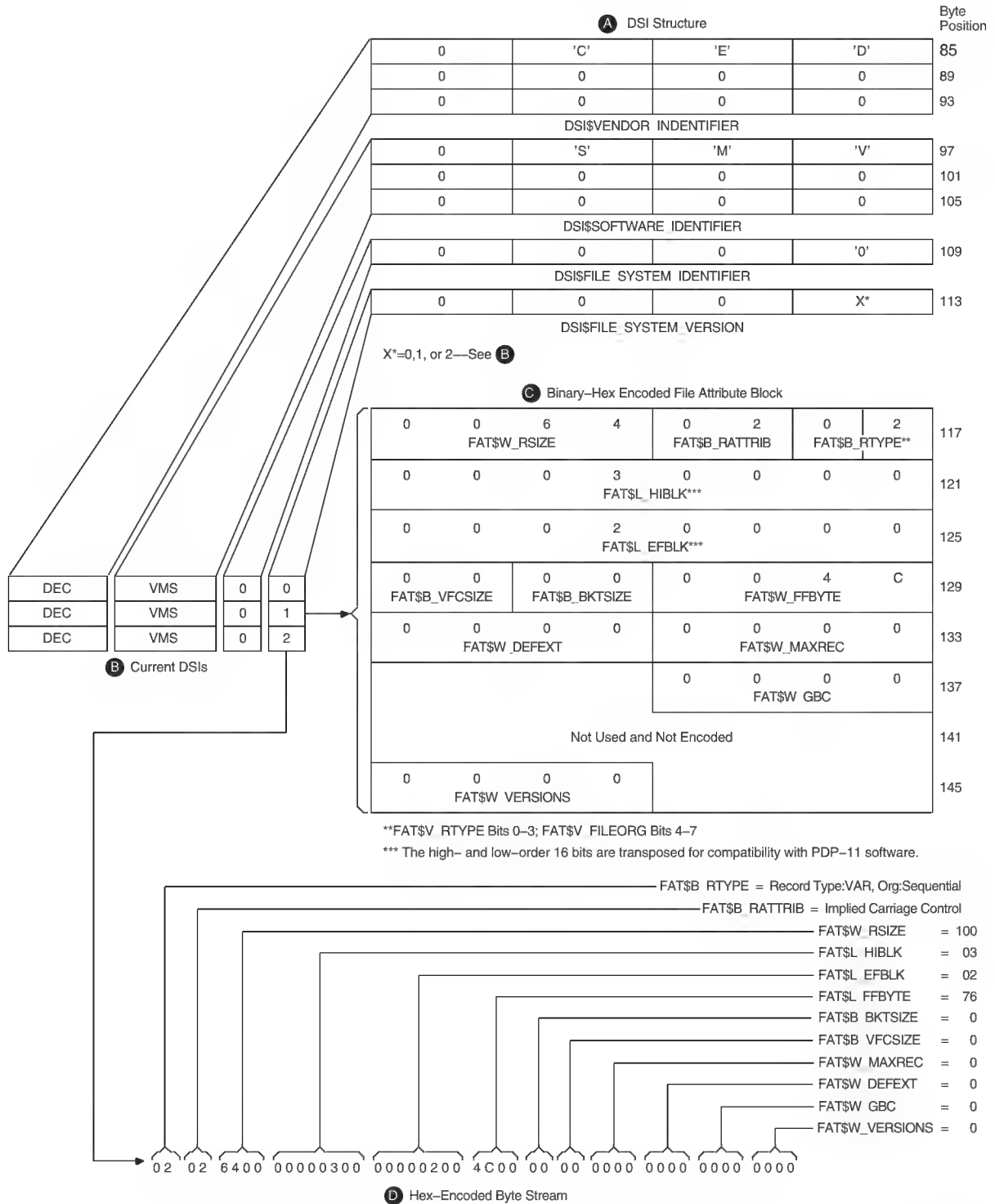

ZK-5075A-GE

## Introduction

### 1.3 Magnetic Tape Concepts

### 1.3 Magnetic Tape Concepts

This section describes magnetic tape concepts. Data records are organized on magnetic tape in the order in which they are entered; that is, sequentially.

Characters of data on magnetic tape are measured in *bits per inch* (bpi). This measurement is called *density*. A 1600-bpi tape can accommodate 1600 characters of data in 1 inch of recording space. A tape has 9 parallel tracks containing 8 bits and 1 parity bit.

A *parity bit* is used to check for data integrity using a scheme where each character contains an odd number of marked bits, regardless of its data bit configuration. For example, the alphabetic character (A) has an ASCII bit configuration of 100 0001, where two bits, the most significant and the least significant, are marked. With an odd-parity checking scheme, a marked eighth bit is added to the character so that it appears as 1100 0001. When this character is transmitted to a receiving station, the receiver logic checks to make sure that the character still has an odd number of marked bits. If media distortion corrupts the data resulting in an even number of marked bits, the receiving station asks the sending station to retransmit the data.

Even though a tape may have a density of 1600 bpi, there are not always 1600 characters on every inch of magnetic tape because of the *interrecord gap* (IRG). The IRG is an interval of blank space between data records that is created automatically when records are written to the tape. After a record operation, this breakpoint allows the tape unit to decelerate, stop if necessary, and then resume working speed before the next record operation.

Each IRG is approximately 0.6 inch in length. Writing an 80-character record at 1600 bpi requires 0.05 inch of space. The IRG, therefore, requires twelve times more space than the data with a resultant waste of storage space.

RMS can reduce the size of this wasted space by using a record blocking technique that groups individual records into a block and places the IRG after the block rather than after each record. (A block on disk is different from a block on tape. On disk, a block is fixed at 512 bytes; on tape, you determine the size of a block.) However, record blocking requires more buffer space for your program, resulting in an increased need for memory. The greater the number of records in a block, the greater the buffer size requirements. You must determine the point at which the benefits of record blocking cease, based on the configuration of your computer system.

Figure 1–5 shows how space can be saved by record blocking. Assume that a 1600-bpi tape contains 10 records not grouped into record blocks. Each record is 160 characters long (0.1 inch at 1600 bpi) with a 0.6-inch IRG after each record; this uses 7 inches of tape. Placing the same 10 records into 1 record block uses only 1.6 inches of tape (1 inch for the data records and 0.6 inch for the IRG).

Figure 1-5 Interrecord Gaps

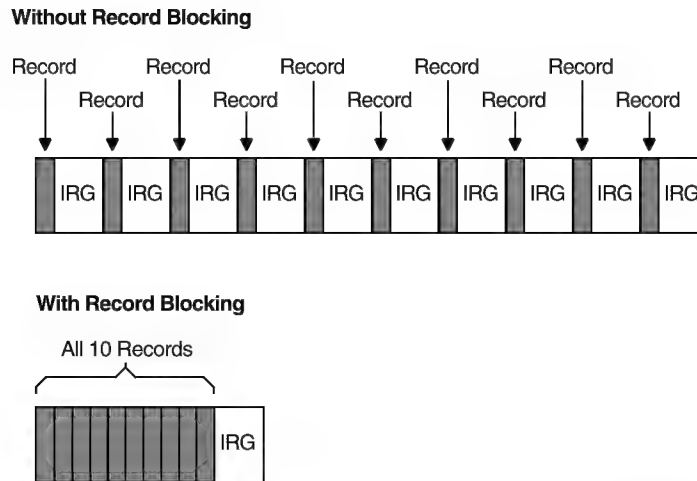

ZK-0741-GE

Record blocking also increases the efficiency of the flow of data into the computer. For example, 10 unblocked records require 10 separate physical transfers, while 10 records placed into a single block require only 1 physical transfer. Moreover, a shorter length of tape is traversed for the same amount of data, thereby reducing operating time.

Like disk data, magnetic tape data is organized into files. When you create a file on tape, RMS writes a set of header labels on the tape immediately preceding the data blocks. These labels contain information such as the user-supplied file name, creation date, and expiration date. Additional labels, called *trailer labels*, are also written following the file. Trailer labels indicate whether or not a file extends beyond a volume boundary.

To access a file on tape by the file name, the file system searches the tape for the header label set that contains the specified file name.

When the data blocks of a file or related files do not physically fit on one volume (a reel of tape or a tape cartridge), the file is continued on another volume, creating a multivolume tape file that contains a volume set. When a program accesses a volume set, it searches all volumes in the set. For additional information about magnetic tapes, see the *OpenVMS System Manager's Manual*.

### 1.3.1 ANSI-Labeled Magnetic Tape

This section describes ANSI magnetic tape labels, data, and record formats supported by OpenVMS operating systems. Note, however, that OpenVMS operating systems also support the ISO standard. For a complete description of these labels, please refer to the ANSI X3.27-1978 or ISO 1001-1979 magnetic tape standard.

## Introduction

### 1.3 Magnetic Tape Concepts

#### 1.3.1.1 Logical Format of ANSI Magnetic Tape Volumes

The format of ANSI magnetic tape volumes is based on Level 3 of the ANSI standard for magnetic tape labels and file structure for information interchange. This standard specifies the format, content, and sequence of volume labels, file labels, and file structures. According to this standard, volumes are written and read on 9-track magnetic tape drives only. The contents of labels must conform to prescribed data and record formats. All labels must consist of ASCII “a” characters.

The ANSI magnetic tape format allows you to write binary data in the file sections (see Figure 1–6) of files. However, if you plan to use such files for information interchange across systems, make sure that the recipient system can read the binary data.

#### 1.3.1.2 RMS Magnetic Tape Ancillary Control Process (MTAACP)

The RMS magnetic tape ancillary control process (MTAACP) is the internal operating system software process that interprets the logical format of ANSI magnetic tape volumes. Transparent to your process, the MTAACP process reads, writes, and interprets ANSI labels before passing this information to RMS and \$QIO system services. These services, in turn, read, write, and interpret the record format of the data written in the file section.

#### 1.3.1.3 Basic Components of the ANSI Magnetic Tape Format

The format of ANSI magnetic tape consists of the following basic components:

- Beginning-of-tape (BOT) and end-of-tape (EOT) markers
- Tape marks
- File sections
- Volume, header, and trailer labels

Figure 1–6 displays the arrangement and function of these components.

**Figure 1–6 Basic Layout of an ANSI Magnetic Tape Volume**

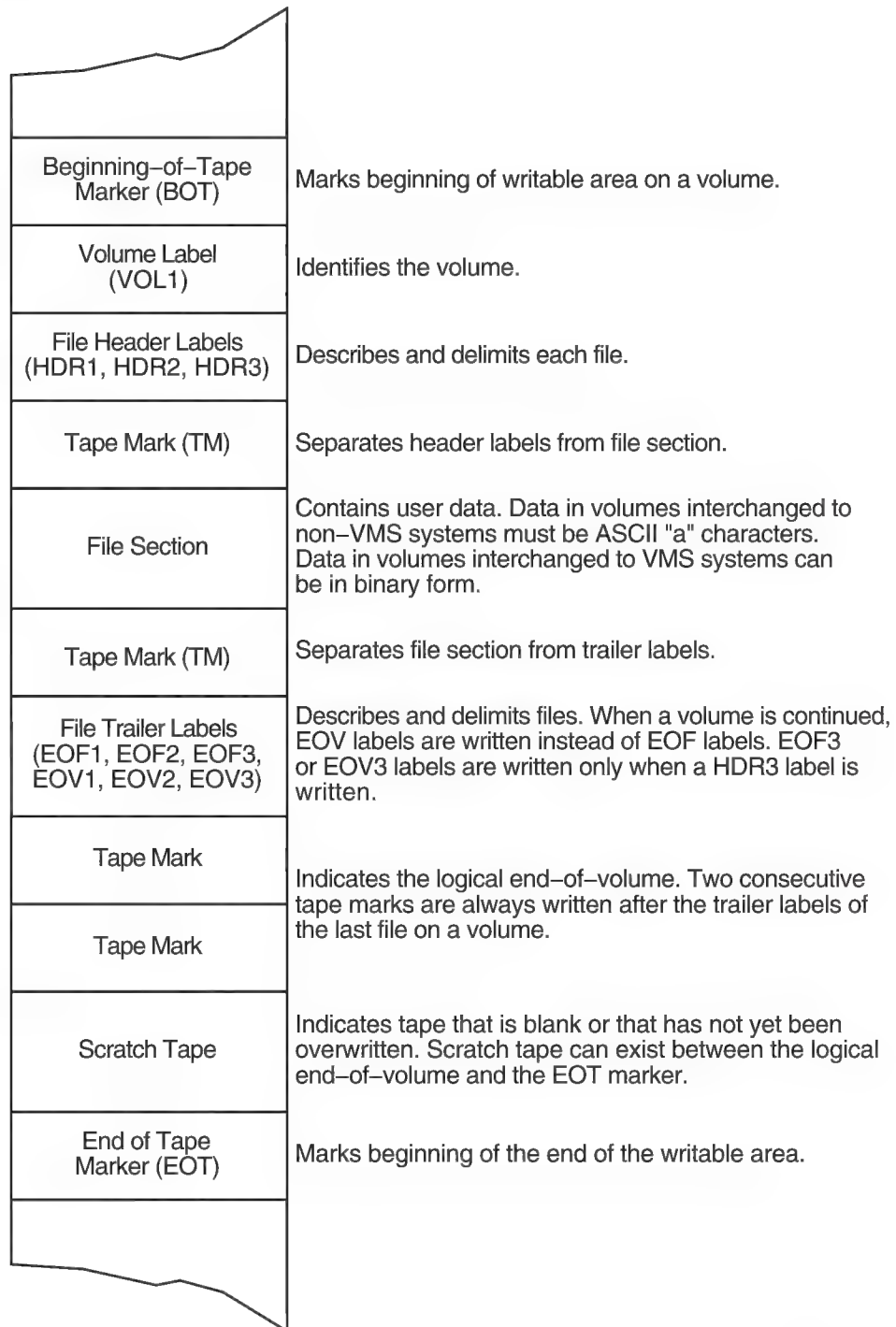

ZK-0981-GE

## Introduction

### 1.3 Magnetic Tape Concepts

#### **Beginning-of-Tape and End-of-Tape Markers**

Every volume has beginning-of-tape (BOT) and end-of-tape (EOT) markers. These markers are pieces of photorefective tape that delimit the writable area on a volume. ANSI magnetic tape standards require that a minimum of 14 feet to a maximum of 18 feet of magnetic tape precede the BOT marker; a minimum of 25 feet to a maximum of 30 feet of magnetic tape, of which 10 feet must be writable, must follow the EOT marker. The EOT marker indicates the start of the end of the writable area of the tape, rather than the physical end of the tape. Therefore, data and labels can be written after the EOT marker.

#### **Tape Marks**

Tape marks separate the file labels from the file sections, separate one file from another, and denote the logical end-of-volume. On the basis of the number and relative placement of tape marks written on a volume, OpenVMS systems determine whether a tape mark delimits a label, a file, or a volume.

Tape marks are written both singly and in pairs. Single tape marks separate either a file section from the header and trailer labels or one file from another. When written after a set of header labels, a single tape mark signals the beginning of a file section. When written before a set of trailer labels, a single tape mark indicates the end of a file section. When written after a trailer label set, a single tape mark separates one file from another.

Double tape marks indicate that either an empty file section exists or the logical end-of-volume has been reached. OpenVMS systems create an empty file when a volume is initialized.

#### **Labels**

Labels identify, describe, and control access to volumes and their files. The ANSI magnetic tape format supports volume, header, and trailer labels. The volume labels are the first labels written on a volume. They identify the volume and the volume owner and specify access protection. Header and trailer labels are sets of labels that identify, describe, and delimit files. Header labels precede files; trailer labels follow files.

Table 1–6 lists the labels supported by OpenVMS operating systems. All other ANSI magnetic tape labels are ignored on input.

Although each type of label uses a different format to organize its contents, all labels conforming to Version 3 of the ANSI magnetic tape standard must consist of ASCII “a” characters. Some labels contain reserved fields designed for future system use or future ANSI magnetic tape standardization. Reserved fields also must consist of ASCII “a” characters; however, OpenVMS systems ignore these characters on input.

**Table 1–6 Labels and Components Supported by OpenVMS Systems**

| Symbol | Meaning   |
|--------|---|
| BOT    | Beginning-of-tape marker  |
| EOF1   | First end-of-file label   |
| EOF2   | Second end-of-file label  |
| EOF3   | Third end-of-file label   |
| EOF4   | Fourth end-of-file label  |
| EOT    | End-of-tape marker label  |
| EOV1   | First end-of-volume label   |
| EOV2   | Second end-of-volume label  |
| EOV3   | Third end-of-volume label   |
| EOV4   | Fourth end-of-volume label  |
| HDR1   | First header label  |
| HDR2   | Second header label   |
| HDR3   | Third header label  |
| HDR4   | Fourth header label   |
| VOL1   | First volume label  |
| VOL2   | Second volume label   |
| TM     | Tape mark   |
| TM TM  | Double tape mark indicates an empty file section or the logical end-of-volume |

#### 1.3.1.4 Volume and File Configurations

ANSI magnetic tape volumes support four file and volume configurations:

- A single file residing on a single volume
- A single file requiring multiple volumes
- Multiple files residing on a single volume
- Multiple files requiring multiple volumes

All these configurations conform to the following guidelines:

- The file sequence number field allows as many as 9999 file sections for one file. In effect, the file length is unlimited.
- Only one file section of a given file is written on a volume.
- When multiple sections exist for one file, each file section is written to a separate volume in the volume set. The file section numbers of each section are written consecutively in ascending order (section  $n+1$  is written immediately following section  $n$ ); file sections of other files are not interspersed.

Each of the file and volume configurations is illustrated in the sections that follow.

## Introduction

### 1.3 Magnetic Tape Concepts

Figure 1–7 Single File on a Single Volume

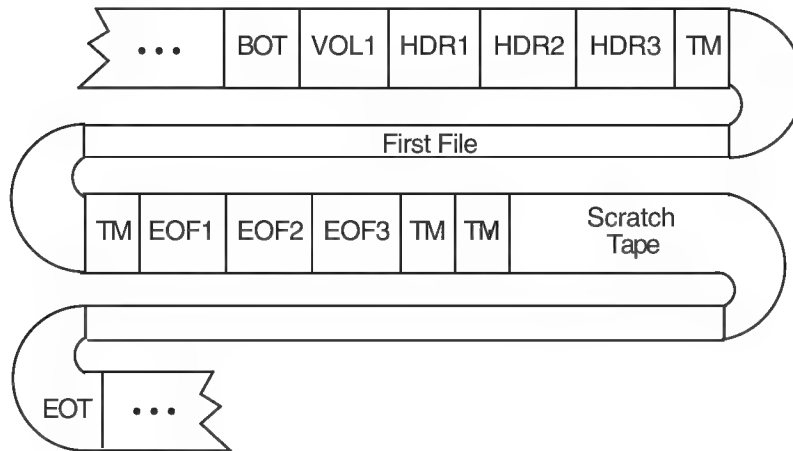

ZK-0346-GE

#### Single File Residing on a Single Tape Volume

A single file on a single tape volume configuration consists of one file on one volume. The components of the ANSI magnetic tape format for this configuration are illustrated in Figure 1–7.

#### Single File Requiring Multiple Tape Volumes

A single-file/multivolume configuration consists of one file that spans two or more volumes in a volume set. Figure 1–8 illustrates the components of the ANSI magnetic tape format for this configuration.

#### Multiple Files on a Single Tape Volume

A multifile/single-volume configuration consists of two or more files on a single volume. It is the most common file and volume configuration. Figure 1–9 illustrates the components of the ANSI magnetic tape format for this configuration.

#### Multifile/Multivolume Configuration

A multifile/multivolume configuration consists of two or more files that span two or more volumes in the same volume set. Figure 1–10 illustrates the components of the ANSI magnetic tape format for this configuration.

**Figure 1–8 Single File on Multiple Tape Volumes**

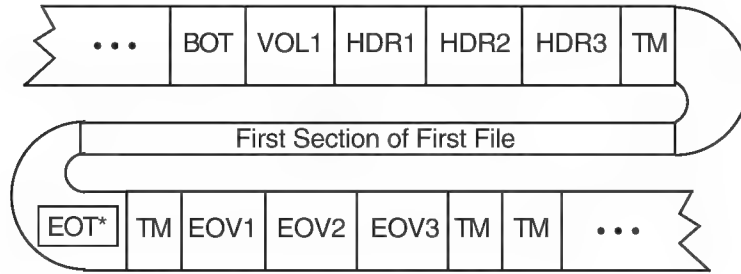

Continuation Volume

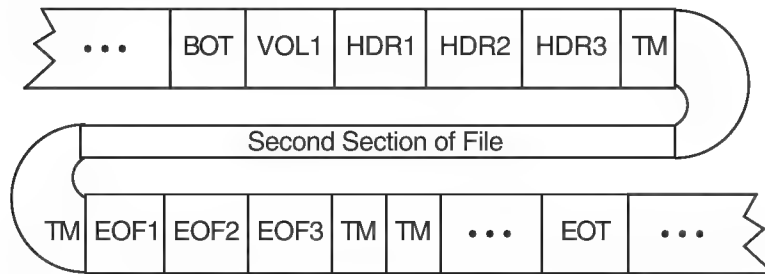

\*When the driver encounters an EOT marker during a write operation, the MTAACP writes the appropriate trailer labels and performs a volume switch, if necessary.

ZK-0347-GE

**Figure 1–9 Multifile/Single-Volume Configuration**

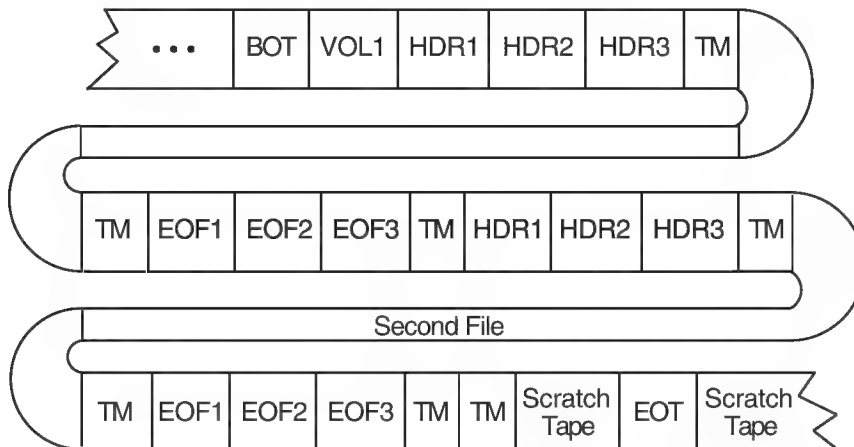

ZK-0345-GE

# Introduction

## 1.3 Magnetic Tape Concepts

Figure 1–10 Multifile/Multivolume Configuration

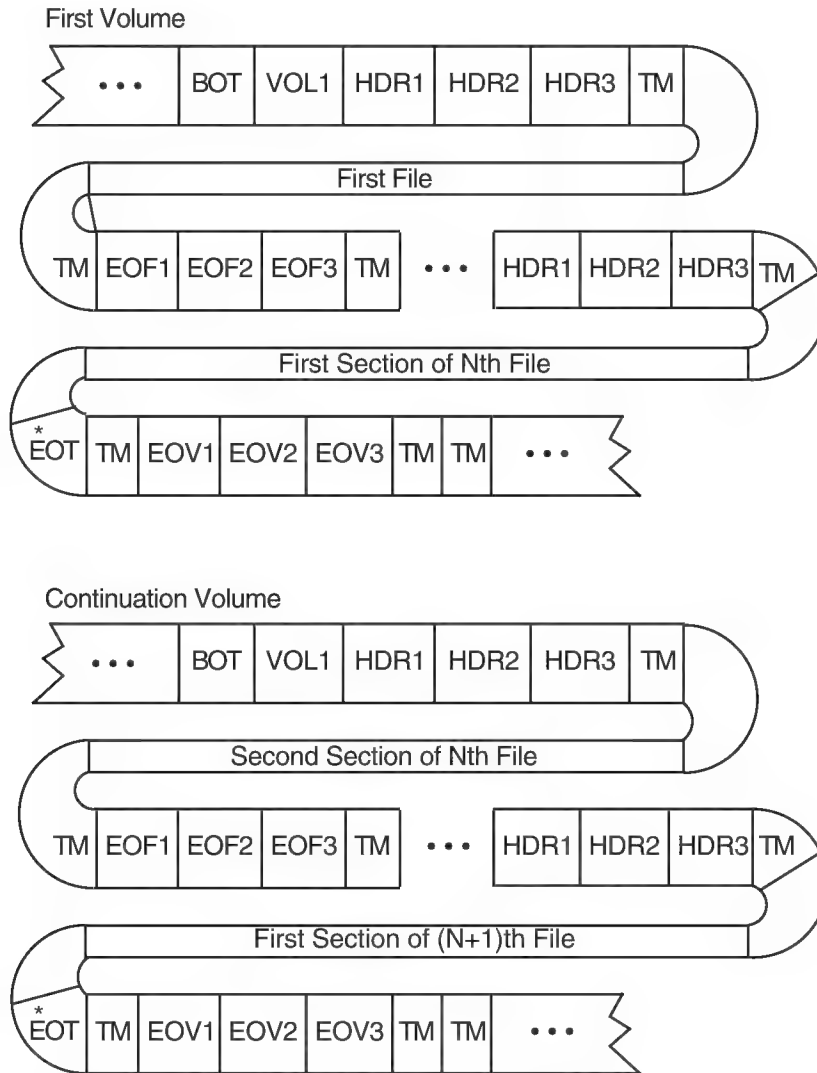

\*When the driver encounters an EOT marker during a write operation, the MTAACP writes the appropriate trailer labels and performs a volume switch, if necessary.

ZK-0348-GE

### 1.3.1.5 Volume Labels

The sections that follow describe the first volume (VOL1) and second volume (VOL2) labels.

**1.3.1.5.1 VOL1 Label** The 80-character volume label (VOL1) is the first label written on an ANSI magnetic tape volume. It defines the label type, name, and owner of the volume. Although there are many fields in a VOL1 label, this section describes only those fields that you can access or that can inhibit access to a volume and its files on OpenVMS systems.

#### Volume Identifier Field

The volume identifier field is a 6-character field that contains the name of the volume. You specify the volume identifier in the command string when you initialize or mount a volume (see the *OpenVMS System Manager's Manual*). The volume identifier consists of six ASCII "a" characters. Lowercase characters are not in the "a" set, but if you specify them, OpenVMS systems change them to uppercase. If you specify fewer than six characters, OpenVMS systems pad the field by right-justifying the field with the ASCII space character.

#### Accessibility Field

The accessibility field is a one-character field that allows an installation to control access to a volume. See the *OpenVMS System Manager's Manual* for a description of accessibility support.

#### Implementation Identifier Field

The implementation identifier field contains the identifier of the implementation that creates the magnetic tape. This field controls how certain implementation-specific fields and volume labels are interpreted. The magnetic tape file system's implementation identifier is DECFILE11 A. This field contains the implementation identifier only if a second volume (VOL2) label is written on the magnetic tape. Otherwise, it is filled with ASCII space characters.

#### Owner Identifier Field

The owner identifier field is available to the user. This field does not affect the checking of a user's access to a volume, except as noted in the *OpenVMS System Manager's Manual*.

**1.3.1.5.2 VOL2 Label** In addition to the first volume (VOL1) label described above, OpenVMS systems provide a second volume (VOL2) label, the volume-owner field.

The volume-owner field contains the OpenVMS protection information that has been written on the magnetic tape. A second volume label is written only if an OpenVMS protection scheme had been specified on either the MOUNT or INITIALIZE command.

The volume-owner field also contains a value that incorporates the user identification code (UIC) with the OpenVMS protection code specified for a volume. By default, OpenVMS systems do not write a UIC to this field, thus allowing all users READ and WRITE access. Note, however, that EXECUTE and DELETE access are not applicable to magnetic tape volumes. Also note that, regardless of the protection code that you specify, both system users and the volume owner always have READ and WRITE access to a volume. The contents of the volume-owner field depends on the OpenVMS protection code that you specify.

## Introduction

### 1.3 Magnetic Tape Concepts

#### 1.3.1.6 Header Labels

OpenVMS operating systems support four file-header labels: HDR1, HDR2, HDR3, and HDR4. The HDR3 and HDR4 labels are optional. The following sections describe and illustrate each file-header label.

**1.3.1.6.1 HDR1 Label** Every file on a volume has a HDR1 label, which identifies and describes the file by supplying the OpenVMS MTAACP with the following information:

- File identifier
- File-set identifier
- File section number
- File sequence number
- Generation and generation version numbers
- File creation and expiration dates
- Accessibility code
- Implementation identifier

#### **File Identifier Field**

The file identifier field contains the first 17 characters of the file name you specify. The remainder of the file name is written into the HDR4 label, provided that this label is allowed. If no HDR4 label is supported, a file name longer than 17 characters will be truncated. You may use either an ANSI magnetic tape file name or an OpenVMS file specification of the following format:

`filename.type;version`

OpenVMS file specifications are a subset of ANSI magnetic tape file names. However, ANSI magnetic tape file names are valid only for magnetic tape volumes; OpenVMS file specifications are valid for disk and tape volumes. Both types of file specifiers are compatible with compatibility mode.

An OpenVMS file specification consists of a file name, a file type, and an optional version number. Valid file names contain a maximum of 39 characters. Valid file types consist of a period followed by a maximum of 39 characters. The semicolon separates the version number from the file type.

Except for wildcard characters, only the characters A through Z, 0 through 9, and the special characters ampersand (&), hyphen (-), underscore (\_), and dollar sign (\$) are valid for OpenVMS file names and types. The period and semicolon are the only other valid special characters, and they are always separators.

ANSI magnetic tape file names do not have a file type field. An ANSI magnetic tape file name consists of a 17-character name string, a period, a semicolon, and an optional version number. You can specify a name string consisting of a maximum of 17 ASCII “a” characters, but you must enclose the string in quotation marks (as in, for example, “file name”). When you specify fewer than 17 characters, the string is padded on the right with spaces to the 17-character maximum size. If you specify a file name that has trailing spaces, OpenVMS systems truncate them when the file name is returned. In addition, the space-padded field prevents you from specifying a unique file name that consists of spaces.

Although you can specify longer file names (up to 79 characters), only the first 17 characters of the file name will be used in interchange.

The quotation mark character requires special treatment because it is both the file name delimiter and a valid ASCII "a" character that can itself be embedded in the name string. You must specify two quotation marks for each one that you want the operating system to interpret. The additional quotation mark informs the operating system that one of the quotation marks is part of the name string, rather than a delimiter.

Embedded spaces also are valid characters, but embedded tabs are not. Lowercase characters are not in the ASCII "a" character set, but if you specify them, OpenVMS systems convert them to uppercase characters.

If you do not specify a file type or version number on input, OpenVMS systems supply a period (the default file type) and a semicolon (the default version number). However, the period and semicolon will not be written to this field on the tape.

Although the operating system considers version numbers for ANSI magnetic tape file names and OpenVMS file names to be part of the file name specification, the version number of a file is not written to the file identifier field but is mapped to the generation number and generation version-number fields as described in Generation Number and Generation Version-Number Fields.

Examples below display ANSI magnetic tape file names. The input is the format that you specify. The output shown displays the OpenVMS format returned to your process and the format written to the label. The number sign (#) in the examples indicates a space character. In the last example, an OpenVMS file name is enclosed in quotation marks, like an ANSI magnetic tape file name, on input. However, the operating system returns the file name to the process as an OpenVMS file name, rather than as an ANSI magnetic tape file name. Therefore, when you enclose a valid OpenVMS file name in quotation marks on input, the operating system parses the file name as an OpenVMS file name.

Input

```
"AB2&D" "FGHI*k4" "#-M";2
#####
"";
"DWDEVOP.DAT"
"VMS_LONG_FILENAME.LONG_FILETYPE"
```

Output to User Process

```
"AB2&D" "FGHI*K4" "#-M";2
"".;
"";
DWDEVOP.DAT;
VMS_LONG_FILENAME.LONG_FILETYPE
```

Output to HDR1 Label

```
AB2&D"FGHI*K4" #-M
#####
""###
DWDEVOP.DAT#####
VMS_LONG_FILENAME
```

## Introduction

### 1.3 Magnetic Tape Concepts

#### File-Set Identifier Field

The 6-character file-set identifier field denotes all files that belong to the same volume set. The file-set identifier for any file within a given volume set should always be the same as the file-set identifier of the first file on the first volume that you mount. The file-set identifier is the same as the volume identifier of the first volume that you mount.

#### File Section Number and File Sequence Number Fields

The file section number is a 4-character field that specifies the number of the file section.

The file sequence number is a 4-character field that specifies the number of the file in a file set.

#### Generation Number and Generation Version-Number Fields

The generation number (a decimal number from 0001 to 9999) and generation version-number (a 2-digit decimal number) fields store the file version number specified on input and written by the system on output. The operating system does not increment the version number of a file, even when the version of the specified file already exists on the volume. Therefore, if the file that you specify has the same file name and version number as an existing file, you will have at least two files with the same version number on the same volume set.

On input, OpenVMS systems compute the version number by using this calculation:

```
version number =  
[(generation number - 1) * 100] + generation version-number + 1
```

Version numbers larger than 32,767 are divided by 32,768; the integer remainder becomes the version number.

On output, the generation number is derived from the version number with this calculation:

```
generation number = [(version number - 1)/100] + 1
```

If there is a remainder after the version number is divided by 100, the remainder becomes the generation version number. It is not added to 1 to form the generation number.

#### Creation Date and Expiration Date Fields

The creation date field contains the date the file is created. The expiration date field contains the date the file expires. The system interprets the expiration date of the first file on a volume as the date that both the file and the volume expire. The creation and expiration dates are stored in the Julian format. This 6-character format (#YYDDD) permits the # symbol to consist of either an ASCII space or an ASCII zero, with the YYDDD consisting of a year and day value. If an ASCII space is indicated, it is assumed that 1900 is added to the 2-digit year value; if an ASCII zero is indicated, it is assumed that 2000 is added to the 2-digit year value. For the YYDDD part of the format, only dates are relevant for these fields; time is always returned as 00:00:00:00.

OpenVMS Version 5.1-1 and later versions implement the ASCII zero to the previously existing ASCII space per the ANSI X3.27-1987 standard, making them year 2000 ready. This ANSI standard is believed to be valid through the year 2100.

OpenVMS versions prior to Version 5.1-1 have known problems initializing and mounting magnetic tapes in the year 2000 and later.

By default, the current date is written to both the creation and expiration date fields when you create a file. Because the expiration date is the same as the creation date, the file expires on creation and you can overwrite it immediately. If the expiration date is a date that is later than the creation date and if the files you want to overwrite have not expired, you must specify the `/OVERRIDE=EXPIRATION` qualifier with the `INITIALIZE` or `MOUNT` command.

To write dates other than the defaults in the date fields in this label, specify the creation date field (CDT) and the expiration date field (EDT) of the RMS date and time extended attribute block (XABDAT).

When you do not specify a creation date, RMS defaults the current date to the creation date field. To specify a zero creation date, you must specify a year before 1900. If you specify a binary zero in the date field, the system will write the current date to the field.

For details on the XABDAT, see the *OpenVMS Record Management Services Reference Manual*.

#### **Accessibility Field**

The contents of this field are described in Section 1.3.1.5.

#### **Implementation Identifier Field**

The implementation identifier field specifies, using ASCII “a” characters, an identification of the implementation that recorded the Volume Header Label Set.

**1.3.1.6.2 HDR2 Label** The HDR2 label describes the record format, maximum record size, and maximum block size of a file.

#### **Record Format Field**

The record format field specifies the type of record format the file contains. The operating system supports two record formats: fixed length (F) and variable length (D). When files contain record formats that the system does not support, it cannot interpret the formats and classifies them as undefined.

Fixed-length records are all the same length. No indication of the record length is required within the records because either the HDR2 label defines the record length or you specify the record length with the `/RECORDSIZE` qualifier. A fixed-length record can be a complete block, or several records can be grouped together in a block.

Fixed-length blocked records are padded to a multiple of 4 records. Variable-length records are padded to the block size. If a block is not filled, it will be padded with circumflex characters (^). The standard does not allow records containing only circumflexes; the system will interpret this as padding, not data.

Figure 1–11 shows a block of fixed-length records. Each record has a fixed length of 50 bytes. All six records are contained in a 300-byte block. The records are blocked—that is, grouped together as one entity—to increase processing efficiency; when records are blocked, you can access many of them with one I/O request. The block size should be a multiple of the record size.

## Introduction

### 1.3 Magnetic Tape Concepts

**Figure 1–11 Blocked Fixed-Length Records**

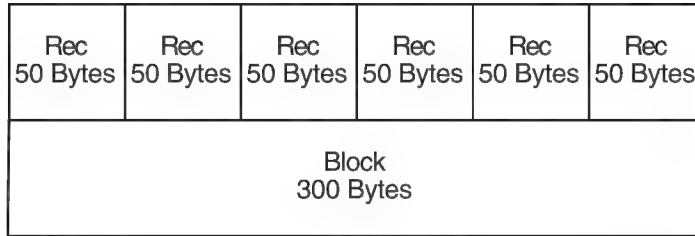

ZK-0353-GE

The size of a variable-length record is indicated by a record control word (RCW). The RCW consists of four bytes at the beginning of each record. A variable-length record can be a complete block, or several records can be grouped together in a block.

Two variable-length records are shown in Figure 1–12. The first consists of 54 bytes, including the RCW. The second consists of 112 bytes, including the RCW. The records are contained in a 166-byte block.

Do not use system-dependent record formats on volumes used for information interchange. OpenVMS system-dependent formats are stream and variable with fixed-length control (VFC).

**Figure 1–12 Variable-Length Records**

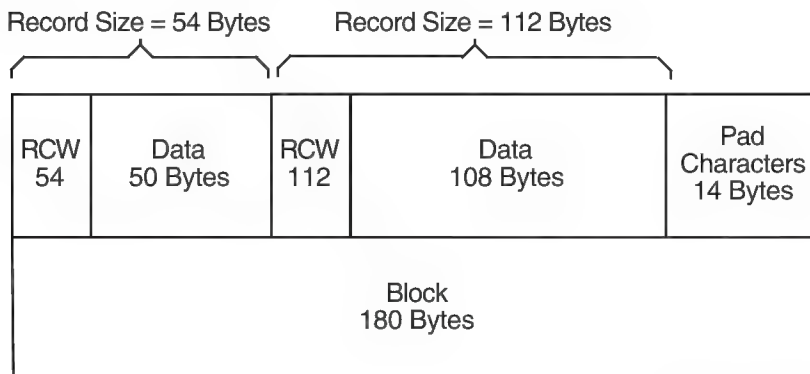

ZK-0354-GE

#### Block Length Field

The block length field denotes the maximum size of the blocks. According to the ANSI magnetic tape standard, valid block sizes range from 18 to 2048 bytes. However, the operating system allows you to specify a smaller or larger block size by using the /BLOCKSIZE qualifier with the MOUNT command. To specify the block size using RMS, see the BLS field in the file access block (FAB) in the *OpenVMS Record Management Services Reference Manual*. When you specify a block size outside the ANSI magnetic tape standard range, the volume may not be processed correctly by other systems that support the ANSI magnetic tape standards.

### Record Length Field

The record length field denotes either the size of fixed-length records or the maximum size of variable-length records in a file. Valid RMS record sizes vary, depending on the record format. The range for fixed-length records is 1 to 65,534 bytes; the range for variable-length records is 4 to 9,999 bytes, including the 4-byte RCW. Therefore, the maximum length of the data area of a variable-length record is 9,995 bytes. To comply with ANSI magnetic tape standards, the record size should not be larger than the maximum block size of 2,048 bytes, even though OpenVMS systems allow larger record sizes (when the block size is larger).

For volumes containing files that do not have HDR2 labels, you must specify MOUNT/RECORDSIZE=*n* at mount time. The variable *n* denotes the record length in bytes. Files without HDR2 labels were created by a system that supports only level 1 or 2 of the ANSI standard for magnetic tape labels and file structure. Records should be fixed length because this is the only record format that either level supports. If you do not specify a record size, each block will be considered a single record.

### Implementation-Dependent Field

The implementation-dependent field contains two 1-character subfields that describe how the operating system interprets record format and form control.

The first subfield, character position 16, denotes whether the RMS attributes are in this label or the HDR3 label. If character position 16 contains a space, the RMS attributes are in the HDR3 label; if it contains any character other than a space, character position 16 is the first byte of the RMS attributes in the HDR2 label. The attributes appear in character positions 16 through 36 and 38 through 50.

The second subfield, the form control field at character position 37, specifies the form control that defines the carriage control applied to records within a file. Possible values supported for RMS magnetic tape volumes are listed below.

|       |  |
|-------|--|
| A     | First byte of record contains Fortran control characters.  |
| M     | The record contains all form control information.  |
| space | Line-feed/carriage-return combination is to be inserted between records when the records are written to a carriage-control device, such as a line printer or terminal. If form control is not specified when a file is created, this is the default. |

### Buffer-Offset Length Field

For implementations that support buffer offsets, the buffer-offset length field indicates the length of information that prefixes each data block. The magnetic tape file system supports the input of buffer offset, which means that the buffer-offset length obtained from the HDR2 label (when reading the file) is used to determine the actual start of the data block. The magnetic tape file system does not support the writing of a buffer offset.

Note that, if you open a file for append or update access and the buffer-offset length is nonzero, the open operation will not succeed.

## Introduction

### 1.3 Magnetic Tape Concepts

**1.3.1.6.3 HDR3 Label** The HDR3 label describes the RMS file attributes. For RMS operations, data in the HDR3 label supersedes data in the HDR2 label.

Although the HDR3 label usually exists for every file on an ANSI magnetic tape volume, there are two situations when this label will not be written. The first is when an empty dummy file is created during volume initialization; no HDR3 label is written because the empty file does not require RMS attributes. The second is when you specify MOUNT/NOHDR3 at mount time. You should use the /NOHDR3 qualifier when you create files on volumes that will be interchanged to systems that do not process HDR3 labels correctly.

The RMS attributes describe the record format of a file. These attributes are converted from 32 bytes of binary values to 64 bytes of ASCII representations of their hexadecimal equivalents for storage in the HDR3 label.

**1.3.1.6.4 HDR4 Label** The HDR4 label contains the remainder of an OpenVMS file name that would not fit in the HDR1 file identifier field.

#### 1.3.1.7 Trailer Labels

The operating system supports two sets of trailer labels: end-of-file (EOF) and end-of-volume (EOV). A trailer label is written for each header label.

EOF and EOV labels are identical to their file header label counterparts except that:

- The label identifier field (characters 1-3) contains EOF or EOV.
- The block count field (characters 55-60) in the EOF1 and EOV1 labels contains the number of data blocks in the file section.

The particular label that OpenVMS systems write depends on whether a file extends beyond a volume. If a file terminates within the limits of a volume, EOF labels are written to delimit the file (see Figure 1-7). If a file extends across volume boundaries before terminating, EOV labels are written, indicating that the file continues on another volume (see Figure 1-8).

## 1.4 Using Command Procedures to Perform Routine File and Device Operations

Many of the operations that you perform on disk and magnetic tape media are routine in nature. Therefore, you will find it worthwhile to take the time to identify those tasks that you routinely perform at your particular site. Once you have isolated those tasks, you can design command procedures to assist you in performing them.

For example, if you are a system manager or an operator, you must frequently perform data integrity tasks such as backing up media. You could enter all of the commands, parameters, and qualifiers required to back up your media each time that you perform the backup operation, or you can write a single command procedure (containing that set of commands, qualifiers, and parameters) that, when executed, would also perform the backup operation.

In order to familiarize yourself with the syntax used to design and execute command procedures, see the *OpenVMS User's Manual*.

## 1.5 Volume Protection

The system protects data on disk and tape volumes to make sure that no one accesses the data accidentally or without authorization. For volumes, the system provides protection at the file, directory, and volume levels. For tape volumes, the system provides protection at the volume level only.

In addition to protecting the data on mounted volumes, the system provides device protection coded into the home block of the disks and tapes. See Section 1.2 for more information.

In general, you can protect your disk and tape volumes with user identification codes (UICs) and access control lists (ACLs). The standard protection mechanism is UIC-based protection. Access control lists permit you to customize security for a file or a directory.

UIC-based protection is determined by an owner UIC and a protection code, whereas ACL-based protection is determined by a list of entries that grant or deny access to specified files and directories.

---

### Note

---

You cannot use ACLs with magnetic tape files.

---

When you try to access a file that has an ACL, the system uses the ACL to determine whether or not you have access to the file. If ACL does not explicitly allow or refuse you access or if the file has no ACL, the system uses the UIC-based protection to determine access. (See the *OpenVMS Guide to System Security* for additional information about system security.)

For detailed information about protecting your files, directories, or volumes, see Section 4.4.

## 1.6 RMS (Record Management Services)

OpenVMS Record Management Services (OpenVMS RMS or simply RMS) is the file and record access subsystem of the OpenVMS operating systems. RMS allows efficient and flexible data storage, retrieval, and modification for disks, magnetic tapes, and other devices.

You can use RMS from low-level and high-level languages. If you use a high-level language, it may not be easy or feasible to use the RMS services directly because you must allocate control blocks and access fields within them. Instead, you can rely on certain processing options of your language's input/output (I/O) statements or upon a specialized language provided as an alternative to using RMS control blocks directly, the *File Definition Language* (FDL).

If you use a low-level language, you can either use record management services directly, or you may use FDL.

### 1.6.1 File Definition Language (FDL)

FDL is a special-purpose language you can use to specify file characteristics. FDL is particularly useful when you are using a high-level language or when you want to ensure that you create properly tuned files. Properly tuned files can be created from an existing file or from a new design for a file. The performance benefits of properly tuned files can greatly affect application and system performance, especially when using large indexed files.

## Introduction

### 1.6 RMS (Record Management Services)

FDL allows you to use all of the creation-time capabilities and many of the run-time capabilities of RMS control blocks, including the *file access block* (FAB), the *record access block* (RAB), and the *extended attribute blocks* (XABs).

For more information about FDL, see Section 4.1.2.

#### 1.6.2 RMS Data Structures

RMS control blocks generally fall into two groups: those pertaining to files and those pertaining to records.

To exchange file-related information with file services, you use a control block called a file access block (FAB). You use the FAB to define file characteristics, file specifications, and various run-time options. The FAB has a number of fields, each identified by a symbolic offset value. For instance, the allocation quantity for a file is specified in a longword-length field having a symbolic offset value of FAB\$L\_ALQ. FAB\$L\_ALQ indicates the number of bytes from the beginning of the FAB to the start of the field.

To exchange record-related information with RMS, you use a control block called a record access block (RAB). You use the RAB to define the location, type, and size of the input and output buffers, the record access mode, certain tuning options, and other information. The symbolic offset values for the RAB fields have the prefix RAB\$ to differentiate them from the values used to identify FAB fields. The RAB symbolic offset values have the same general format, where the letter following the dollar sign indicates the field length and the letters following the underscore are a mnemonic for the field's function. For example, the multibuffer count field (MBF) specifies the number of local buffers to be used for I/O and has the symbolic offset value RAB\$B\_MBF. The value of RAB\$B\_MBF is equal to the number of bytes from the beginning of the RAB to the start of the field.

Where applicable, RMS uses control blocks called *extended attribute blocks* (XABs), together with FABs and RABs, to support the exchange of information with RMS. For example, a Key Definition XAB specifies the characteristics for each key within an indexed file. The symbolic offset values for XAB fields have the common prefix XAB\$.

For more information about RMS control blocks, see Chapter 4.

#### 1.6.3 Record Management Services

Because RMS performs operations related to files and records, services generally fall into one of two groups:

- Services that support file processing. These services create and access new files, access (or open) previously created files, extend the disk space allocated to files, close files, get file characteristics, and perform other functions related to the file.
- Services that support record processing. These services get (extract), find (locate), put (insert), update (modify), and delete (remove) records and perform other record operations.

For more information about the various services, see Chapter 7 and Chapter 8.

## 1.7 RMS Utilities

The following are RMS file-related utilities:

- The Analyze/RMS\_File utility
- The Convert utility
- The Convert/Reclaim utility
- The Create/FDL utility
- The Edit/FDL utility

These utilities let you design, create, populate, maintain, and analyze data files that can use the full set of RMS create-time and run-time options. They help you create efficient files that use a minimum amount of system resources, while decreasing I/O time.

For more information about the record management utilities, see the *OpenVMS Record Management Utilities Reference Manual*.

### 1.7.1 The Analyze/RMS\_File Utility

With the Analyze/RMS\_File utility (ANALYZE/RMS\_FILE), you can perform five functions:

- Inspect and analyze the internal structure of an RMS file
- Generate a statistical report on the file's structure and use
- Interactively explore the file's internal structure
- Generate an FDL file from an RMS file
- Generate a summary report on the file's structure and use

ANALYZE/RMS\_FILE is particularly useful in generating an FDL file from an existing data file that you can then use with the Edit/FDL utility (also called the FDL editor) to optimize your data files. Alternatively, you can provide general tuning for the file without the FDL editor.

To invoke the Analyze/RMS\_File utility, use the following DCL command line format:

```
ANALYZE/RMS_FILE filespec[,...]
```

The **filespec** parameter lets you select the data file you want to analyze.

For more information about the Analyze/RMS\_File utility, refer to Chapter 10 of this manual and the *OpenVMS Record Management Utilities Reference Manual*.

### 1.7.2 The Convert Utility

The Convert utility (CONVERT) copies records from one or more files to an output file, optionally changing the record format and file organization to that of the output file. Note that the Convert utility processes relative files by sequentially reading records from the input file, then writing them to the output file. As a result, the relative record numbers (RRN) change when the input file contains deleted or unused records.

CONVERT is particularly useful in the tuning cycle of a file. After you have analyzed and optimized the file, you can use CONVERT to create a new file having the new, optimized characteristics and to copy the records in the old file

## Introduction

### 1.7 RMS Utilities

to the new file. You can also use CONVERT to reformat an indexed file that has had many record insertions or deletions.

To invoke the Convert utility, use the following DCL command line format:

```
CONVERT input-filespec[,...] output-filespec
```

Use the **input-filespec** parameter to specify the file or files you want to convert, and use the **output-filespec** parameter to specify a destination file for the converted records.

Figure 1–13 shows how CONVERT creates data files and loads them with converted records from an input file.

**Figure 1–13 Using CONVERT to Create a Data File**

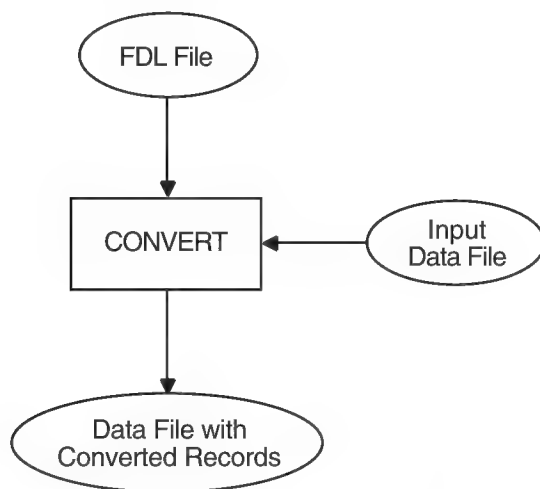

ZK-0946-GE

For more information about the Convert utility, refer to Chapter 4 and the *OpenVMS Record Management Utilities Reference Manual*.

#### 1.7.3 The Convert/Reclaim Utility

The Convert/Reclaim utility reclaims empty buckets in Prolog 3 indexed files so that new records can be added to them. A bucket is a storage structure that RMS uses to build and process files.

The Convert/Reclaim utility does an “in-place” reorganization of the file in contrast to the Convert utility, which creates a new file from the old file. For this reason, the Convert/Reclaim utility is more appropriate for large disk files where space is limited. Before using the Convert/Reclaim utility, be sure to back up the file.

For more information about the Convert/Reclaim utility, see Chapter 4 of this manual and the *OpenVMS Record Management Utilities Reference Manual*.

### 1.7.4 The Create/FDL Utility

The Create/FDL utility (CREATE/FDL) uses the specifications in an existing FDL file to create a new, empty data file.

To invoke this utility, use the following DCL command line format:

```
CREATE/FDL=fdl-filespec [filespec]
```

The **fdl-filespec** parameter specifies the source FDL file for creating the data file. The **filespec** parameter gives you the option of assigning a file specification to the data file.

Figure 1–14 shows how the CREATE/FDL utility creates empty data files from the specifications in an FDL file.

For more information about the CREATE/FDL utility, see Chapter 4 and the *OpenVMS Record Management Utilities Reference Manual*.

**Figure 1–14 Using CREATE/FDL to Create an Empty Data File**

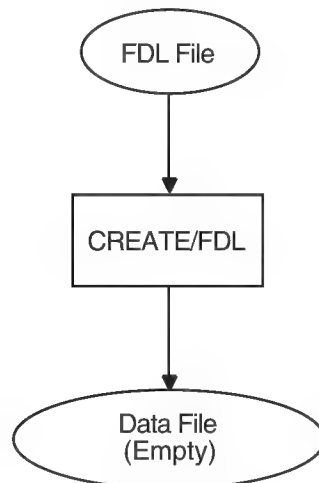

ZK-0945-GE

### 1.7.5 The Edit/FDL Utility

The Edit/FDL utility (EDIT/FDL) creates and modifies files that contain specifications for RMS data files. The specifications are written in the file definition language, and the files are called FDL files.

A completed FDL file is an ordered sequence of file attribute keywords and their associated values. By using an FDL file to specify the characteristics of a data file, you can use most of the RMS capabilities without having to access the RMS control blocks directly.

While you are designing the data model, EDIT/FDL informs you of syntax errors and the effects of altering file characteristics. Using EDIT/FDL, you can experiment with attributes that are critical to the record-processing performance of the file, and you can calculate optimum file size.

For example, the depth of an index is an important consideration in designing an indexed file, and bucket size is one variable that determines the number of levels. EDIT/FDL can show the effects of varying the bucket size on the index depth to help you choose the optimum bucket size.

## Introduction

### 1.7 RMS Utilities

To invoke this utility, use the following DCL command line format:

```
EDIT/FDL fdl-filespec
```

The **fdl-filespec** parameter specifies the FDL file you want to create, modify, or optimize.

For more information about the Edit/FDL utility, see the *OpenVMS Record Management Utilities Reference Manual*.

## 1.8 Process and System Resources for File Applications

To use RMS files efficiently, your application requires various process and system resources. You may have to adjust specific resources and quotas for the process running a file application. Before using RMS options, you should consider their impact on process and system resources. In some cases, you may need additional memory or disk drives to ensure that sufficient system resources are available.

### 1.8.1 Memory Requirements

One of the most important ways to improve application performance is to allocate larger buffer areas or more buffers for an application. As described in Chapter 7, the number of buffers and the size of buckets and blocks can be fine tuned on the basis of the way the file will be accessed. For indexed files, the index structure and other factors must also be considered.

When a file is opened or created, RMS maintains the buffers and control structures charged to process memory use. Memory use generally increases with the number of files to be processed at the same time. The amount of memory needed for I/O buffers can vary greatly for each file, but the amount of memory needed for control structures is fairly constant.

The memory use (working set) of a process is governed by three resource limits:

- Working set default (WSDEFAULT)
- Working set quota (WSQUOTA)
- Working set extent (WSEXTENT)

These values can ensure that the process has sufficient memory to perform the application with minimum paging. For a complete description of these limits, see the *OpenVMS System Manager's Manual*.

In addition to process requirements, you may want a shared file to use global buffers to avoid needless I/O when the desired buffer is already in memory. Global buffer usage is limited by the following system parameters:

- RMS global buffer quota (RMS\_GBLBUFQUO)
- Global sections (GBLSECTIONS)
- Global pages (GBLPAGES)
- Global page-file pages (GBLPAGFIL)

When DCL opens a process-permanent file, RMS places internal structures for the file in a special portion of P1 space called the *process I/O segment*. The segment size is determined by the system parameter PIOPAGES and cannot be expanded dynamically. If there is insufficient space in the process I/O segment for the internal structures, DCL generates an error message and does not open the file.

## 1.8 Process and System Resources for File Applications

For a complete description of these parameters, see the *OpenVMS System Manager's Manual*.

### 1.8.2 Process Limits

If you anticipate asynchronous record I/O or are going to access a shared file, you should consider the following process limits:

- Asynchronous system trap limit (ASTLM)
- Buffered I/O limit (BIOLM)
- Direct I/O limit (DIOLM)
- Enqueue quota limit (ENQLM)
- Open file limit (FILLM)

For a complete description of these process limits, see the *OpenVMS System Manager's Manual*.



---

## Choosing a File Organization

When you write an application program, you want the program to input data, process it, store it, update it if necessary, and output it at the right time in the right format. Moreover, the program should perform these functions quickly and accurately.

To achieve this objective, you should consider the structure of your data files and the data processing capabilities available to you through OpenVMS RMS, referred to hereafter as RMS.

You should consider these factors when you write the application program, especially if you have many users simultaneously accessing large files, or if you have a high level of file activity where many records are stored, retrieved, updated, or deleted in a given time period.

You may later reconsider these factors if you are not satisfied with the application program's performance.

This chapter describes file design and structure to help you make the first important design decision: selecting a file organization. Section 2.1 covers record access modes and formats. Section 2.2 describes file concepts and organization.

See Chapter 3 for a description of performance criteria that will help you to evaluate the performance of your data files.

All of the RMS features described in this chapter are available at the VAX MACRO programming level, and many are available to higher-level OpenVMS programming languages that use FDL as an intermediary to the RMS control blocks. (See the descriptions of the FDL routines in the *OpenVMS Utility Routines Manual* for details.)

High-level languages may support only a subset of RMS features. If you intend to use RMS from a high-level language, refer to your language manual to determine the RMS capabilities available to you.

### 2.1 Record Concepts

In considering the structure of your data files, note that a file is an ordered collection of logically related records treated as a unit.

One design consideration is the way records are transferred to your program from storage. For disk files, the smallest unit of transfer is a *block*, but records are usually transferred in multiple blocks using transfer units that are primarily dictated by file organization. If you use the sequential file organization, the multiblock run-time option allows multiple blocks to be transferred during a single I/O operation. Relative files and indexed files use buckets to transfer records. A *bucket* is a storage structure, consisting of 1 to 63 blocks, used for building and processing relative and indexed files.

## Choosing a File Organization

### 2.1 Record Concepts

Another design consideration is how records are accessed: the *record access mode*. The record access mode specifies the way your program stores and retrieves file records.

A third consideration in designing files is how records are formatted. The program that creates the file specifies its record format. Any program that accesses the file must conform to the defined record format.

A fourth consideration is record layout. The record layout defines the number and length of record fields. For example, a program that creates records in a payroll file might use a record layout containing the following fields:

- Employee name
- Social security number
- Pay rate
- Deductions

The next two sections describe RMS record access modes and record formats, respectively.

#### 2.1.1 Record Access Modes

RMS provides two record access modes: sequential access and random access. Random access can be further catalogued as one of the three following modes:

- Random access by key value
- Random access by relative record number
- Random access by record file address (RFA)

Although you cannot change its file organization after you create a file, you can change the record access mode each time you access a record in the file. For example, a relative file can be processed in sequential access mode one time and in a random access mode the next time. Table 2–1 lists the combinations of record access modes and file organizations supported by RMS.

**Table 2–1 Supported Record Access Modes and File Organizations**

| Access Mode                      | File Organization |          |         |
|----------------------------------|-------------------|----------|---------|
|                                  | Sequential        | Relative | Indexed |
| Sequential                       | Yes               | Yes      | Yes     |
| Random by relative record number | Yes <sup>1</sup>  | Yes      | No      |
| Random by key value              | No                | No       | Yes     |
| Random by record file address    | Yes <sup>2</sup>  | Yes      | Yes     |

<sup>1</sup>Permitted with fixed-length record format on disk devices only

<sup>2</sup>Permitted on disk devices only

The following sections describe the record access modes and the capability for switching from one mode to another during program execution.

### 2.1.1.1 Sequential Access

In sequential access mode, storage or retrieval begins at a designated point in the file and continues sequentially through the file. RMS begins accessing records at the start of the file, unless you either specify the starting point explicitly or establish a starting point through a previous operation.

In the sequential access mode, your program issues a series of requests to RMS to retrieve or store succeeding records in a file. Before acting on these requests, RMS checks the file organization to determine how to proceed. The following sections describe how RMS handles sequential access for each of the three file organizations.

#### Sequential Access to Sequential Files

In a sequential file, records are stored adjacent to one other. To retrieve a particular record within the file, your program must open the file and successively retrieve all records between the current record position and the selected record.

Figure 2–1 shows a disk surface. Each lettered section on the surface represents a record in a sequential file, beginning with record A. When the program requests sequential access to the file records, RMS interprets each request in the context of the file's organization.

Because this particular file is sequential, RMS complies with each request (except for the first request) by accessing the record immediately following the previously accessed record. For example, after RMS accesses record A, it updates the current-record position to record B in anticipation of the next request.

Figure 2–1 Sequential Access to a Sequential File

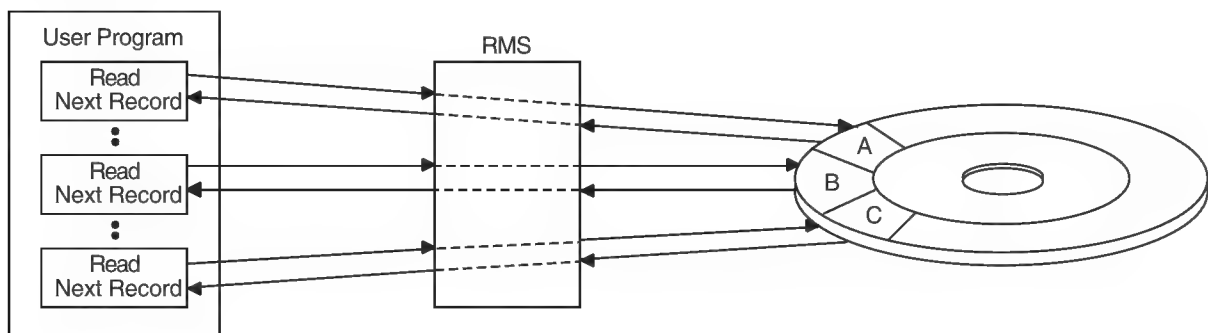

ZK-0747-GE

There are limitations imposed by sequential access. When accessing data sequentially, a program can access a previous record only by reopening or rewinding the file, or by switching to a random access mode. (See Chapter 8 for details.) Another limitation of sequential access is that you can add records only to the end of the file.

#### Sequential Access to Relative Files

Relative files may be accessed sequentially even if some of the fixed-length file cells are empty (because records were never stored in them or because records were deleted from them). RMS ignores empty cells and sequentially searches for the next occupied cell. For example, assume a relative file contains records only in cells 1, 3, and 6. RMS responds to a sequential retrieval request by retrieving the record in cell 1, then the record in cell 3, and then the record in cell 6.

## Choosing a File Organization

### 2.1 Record Concepts

Figure 2–2 shows how RMS checks each cell, ignores an empty cell when it finds one, and then checks the next cell for a record.

**Figure 2–2** Sequentially Retrieving Records in a Relative File

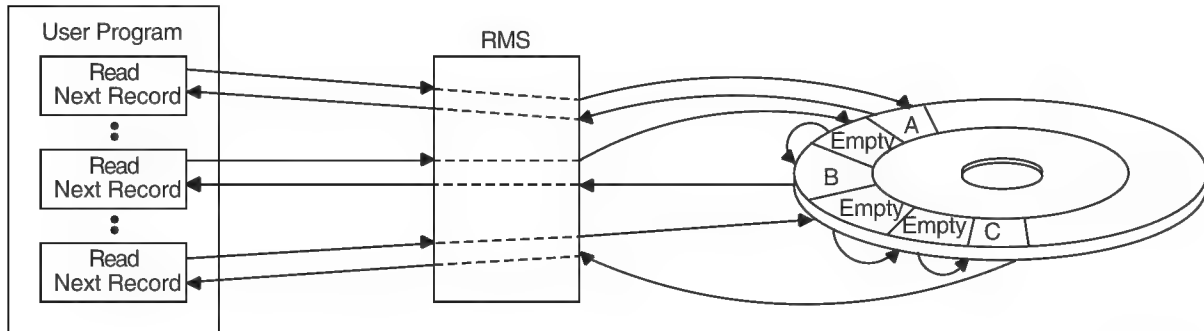

ZK-0748-GE

When storing records sequentially in a relative file, RMS places each new record in the cell whose relative record number is one higher than the most recently accessed cell, provided the cell is empty. If the cell is not empty, the new record cannot be stored in it. Instead, RMS returns an error status.

As Figure 2–3 shows, the program directs RMS to store record F in cell 2. Record A already occupies cell 1 but cell 2 is empty, so RMS can store the record in this cell. If this request is followed by a request to sequentially store the next record, RMS stores the record in cell 3, which is also empty. However, if the program tries to store a new record in the next cell (which already contains record B), the attempt fails.

Note that although RMS cannot store a new record in a cell that is already occupied, your program can modify the record occupying the cell.

Figure 2-3 Sequentially Storing Records in a Relative File

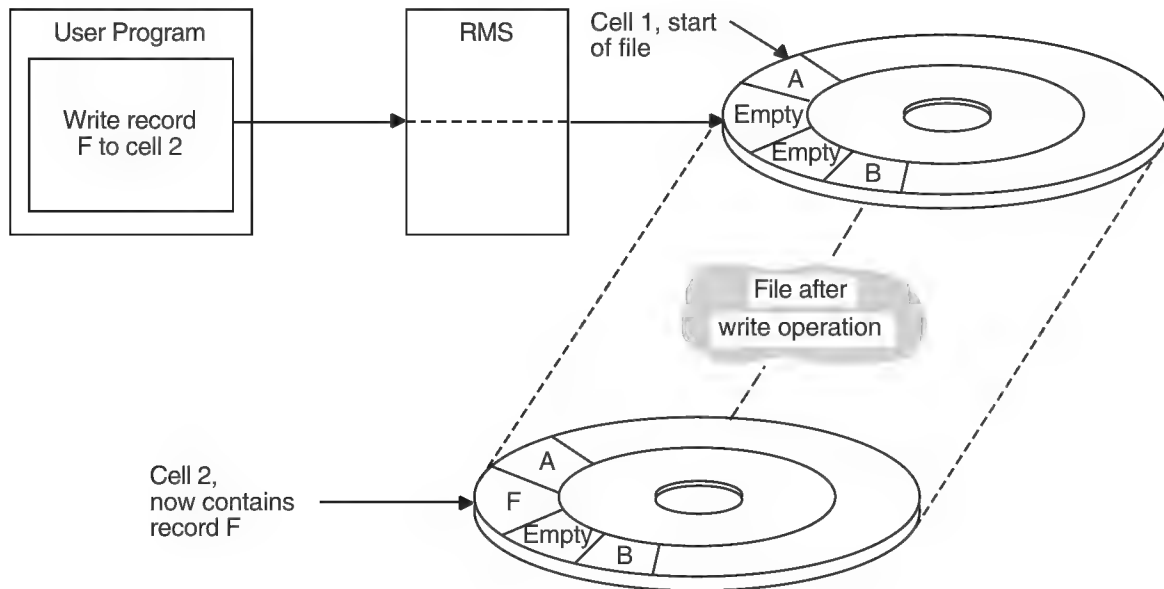

ZK-0749-GE

### Sequential Access to Indexed Files

When a program sequentially accesses an indexed file, RMS uses one or more indexes to determine the order in which to process the file records. Because index entries are ordered by key values, an index represents a logical ordering of the records in the file. If you define more than one key for the file, each index associated with a key represents a different logical ordering of the records in the file. Your program can then use the sequential access mode to retrieve records in the logical order represented by any index.

To retrieve records sequentially from an indexed file, your program must first specify a key of reference (for example, primary key, first alternate key, second alternate key, and so on). For successive retrievals, RMS uses the appropriate index to retrieve records based on how the records are ordered in the index.

If RMS accesses the index in ascending sort order, it returns the record with a key value equal to or higher than the key value in the previously accessed record. Conversely, if RMS accesses records in descending order, it accesses the next record having a key value equal to or lower than the key value in the previously accessed record. In contrast to a request to retrieve data sequentially from an indexed file, a request to store data sequentially in an indexed file does not require a key of reference. Rather, RMS uses the definition of the primary key to place the record in the primary index and, where applicable, uses the definition of the appropriate alternate key to place a record pointer in the alternate index.

When a program issues a series of requests to sequentially store data, RMS verifies that the key value in each successive record is ordered correctly.

## Choosing a File Organization

### 2.1 Record Concepts

#### 2.1.1.2 Random Access by Key Value or Relative Record Number

RMS supports random access for all relative files, all indexed files, and a restricted set of sequential disk files—those having fixed-length records. In random access mode, your program (not the file organization) determines the record processing order. For example, to randomly access a record in a relative file or a record in a sequential disk file having fixed-length records, your program must provide the relative record number of the cell containing the record. Similarly, to randomly access a record from an indexed file, your program must provide the appropriate key of reference and key value.

#### Random Access to Sequential and Relative Files

Unlike sequential access, random access follows no specific pattern. Your program may make successive requests for storing or retrieving records anywhere within the file. In Figure 2–4, the program directs RMS to retrieve the record from the sixth cell in a relative file (record C) and then requests RMS to retrieve record F, which occupies the second cell.

Figure 2–4 Random Access by Relative Record Number

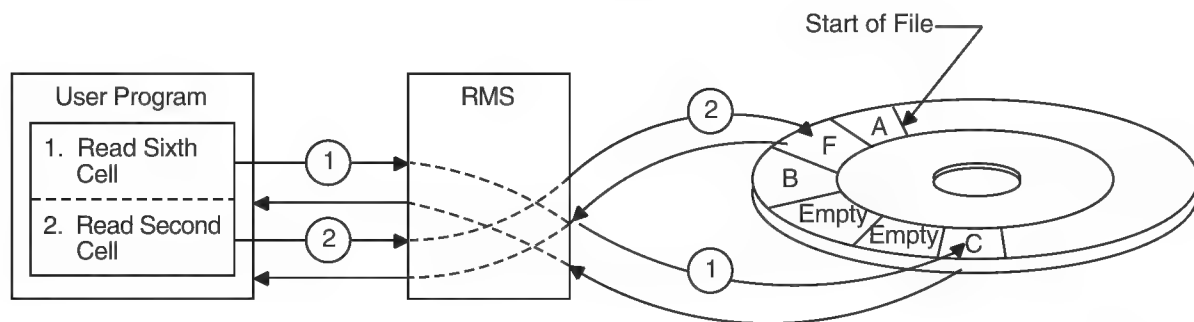

ZK-0750-GE

Compare Figure 2–4 with Figure 2–1 and Figure 2–2.

#### Random Access to Indexed Files

To randomly access a record from an indexed file, your program must specify both a key value and the index that RMS must search (for example, primary index, first alternate key index, and so on). When RMS finds a record with a matching key value, it passes the record to your program.

Your program can use several methods to randomly access a record by key:

- Exact match of key values.
- Approximate match of key values. When accessing an index in ascending sort order, RMS returns the record that has the next higher key value. Conversely, when it accesses the index in descending sort order, RMS returns the record that has the next lower key value.
- Generic match of key values. Applies to string data-type keys only (STRING, DSTRING, COLLATED and DCOLLATED). For a generic match, the program need specify only a match of some specified number of leading characters in the key.
- Combination of approximate and generic match.

Chapter 8 describes these key match conditions in more detail.

In contrast to record retrieval requests, program requests to store records randomly in an indexed file do not require the separate specification of a key value. All keys (primary and any alternate key values) are in the record itself.

When your program opens an indexed file to store a new record, RMS uses the key definitions in the file to find each key field in the record and to determine the length of each key. After writing the new record into the file, RMS uses the record's key values to make appropriate entries in the related indexes so that the record can be accessed subsequently using any of its key values.

### 2.1.1.3 Random Access by Record File Address

Every record on disk has a unique file address—the *record file address (RFA)*—that provides another way to randomly retrieve records in all types of file organizations.

---

**Note**

---

RFA mode provides the *only* means of randomly accessing variable-length records in a sequential file.

---

An important feature of the RFA is that it remains constant as long as the record is in the file. RMS returns the RFA to your program each time the record is retrieved or stored. Your program can either ignore the RFA or keep it as a random-access pointer to the record for subsequent accesses.

Figure 2–5 contains two illustrations. The first shows that when a record is stored, its RFA is returned to the program. The second shows that when the program wants to access the record randomly, it provides RMS with the RFA.

# Choosing a File Organization

## 2.1 Record Concepts

Figure 2-5 Random Access by Record File Address

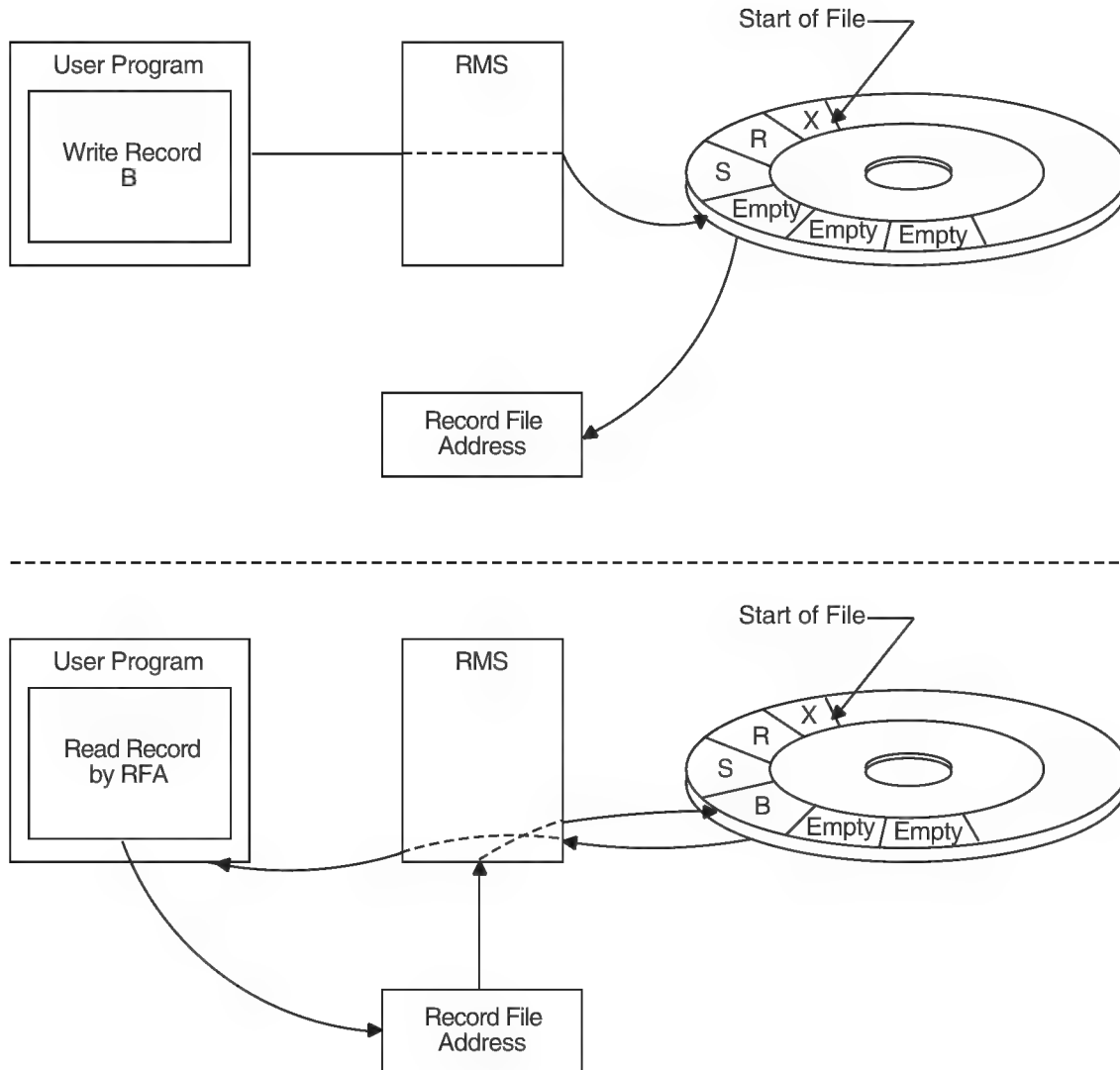

ZK-0751-GE

### 2.1.2 Record Formats

Except for the key values that are part of the records in indexed files, RMS is less concerned with the record content than with the record's format, that is, the way the record physically appears on the recording surface of the storage medium.

RMS supports four record formats:

- Fixed-length format
- Variable-length format
- Variable-length with fixed-length control field (VFC) format
- Stream format

The fixed-length and variable-length record formats are supported for all three file organizations. The variable-length with fixed-length control field (VFC) record format is supported only for sequential and relative files.

---

#### Note

---

In relative files, all records are in fixed-length cells regardless of their format.

---

RMS supports the stream format for sequential files only.

At the VAX MACRO level, you may specify the record format for a file directly by using the FAB\$B\_RFM field in the FAB.

#### 2.1.2.1 Fixed-Length Record Format

When you specify fixed-length record format, all file records are the same length and each record begins on an even-byte boundary. For example, when you specify 9-byte, fixed-length records, each block can hold up to 51 records (512/10) not 56 records (512/9).

When you accept the block span option (the default), the maximum fixed-length record size for sequential files is 32767 bytes. If you specify no block spanning, the maximum fixed-length record size is 512 bytes (one block). For additional information about selecting the block span option, see the *OpenVMS Record Management Services Reference Manual*.

The record length set at file-creation time cannot be changed. It becomes part of the information that RMS stores and maintains for the file.

For the fixed-length record format, each record occupies the same amount of space in the file, and the specified length must be able to accommodate the longest record in the file. If any record fields are not used, your program must be able to detect them and provide appropriate error processing. If you specify the block span option, records are limited to 512 bytes.

#### 2.1.2.2 Variable-Length Record Format

When you specify the variable-length record format, each record is as long as the data within it requires, except that all records are padded to an even number of bytes. The number of bytes is encoded in a 2-byte count field prefixed to the record.

The field may be coded in either LSB (least significant byte) or MSB (most significant byte) format.

The count field for each record begins on an even-byte boundary and contains the number of bytes in the record. RMS builds the count field from information in your program and treats it separately from the associated record data field.

RMS uses the following types of variable-length record formats:

|                |  |
|----------------|--|
| V (LSB) format | Applies to variable-length records in disk files. RMS prefixes the data portion of each variable-length V (LSB) record with a 2-byte, binary count field in LSB format that specifies the length of the record in bytes, excluding the count field itself. |
|----------------|--|

## Choosing a File Organization

### 2.1 Record Concepts

|                |  |
|----------------|--|
| V (MSB) format | Applies to variable-length records in disk files. RMS prefixes the data portion of each record with a 2-byte, binary count field in MSB format that specifies the length of the record in bytes, excluding the count field itself.   |
| D format       | Applies to variable-length records in tape files. To comply with the American National Standard X3.27-1978 (Level 3), <i>Magnetic Tape Labels and Record Formats for Information Interchange</i> , RMS stores a 4-byte decimal count field before the data field of each record on a magnetic tape volume. In contrast to V-format records, the count field is considered as part of the record; but before returning the count, RMS adjusts it to include only the length of the record data. |

When you create a file of variable-length records, specify the value (in bytes) of the largest record permitted in the file.

If you take the block span option (the default), the maximum variable-length record size is 32767 bytes. If you specify no block spanning, the maximum variable-length record size is 510 bytes. For additional information about selecting the block span option, see the *OpenVMS Record Management Services Reference Manual*.

Any attempt to store a record containing more bytes than the specified value results in an error. If you specify a value of 0, any length record can be stored; however, you must consider the bucket capacity limitation defined for relative and indexed files.

Figure 2–6 compares fixed-length record formats and variable-length record formats as they apply to sequential files. Each format shows a portion of a file that contains three records. The comparable record in each format contains the same number of bytes. The first record has 8 bytes, the second, 16, and the third, 24. For the fixed-length record format, the record length is set at 32 bytes. Therefore, RMS considers all 32 bytes to be used.

Figure 2-6 Comparison of Fixed- and Variable-Length Records

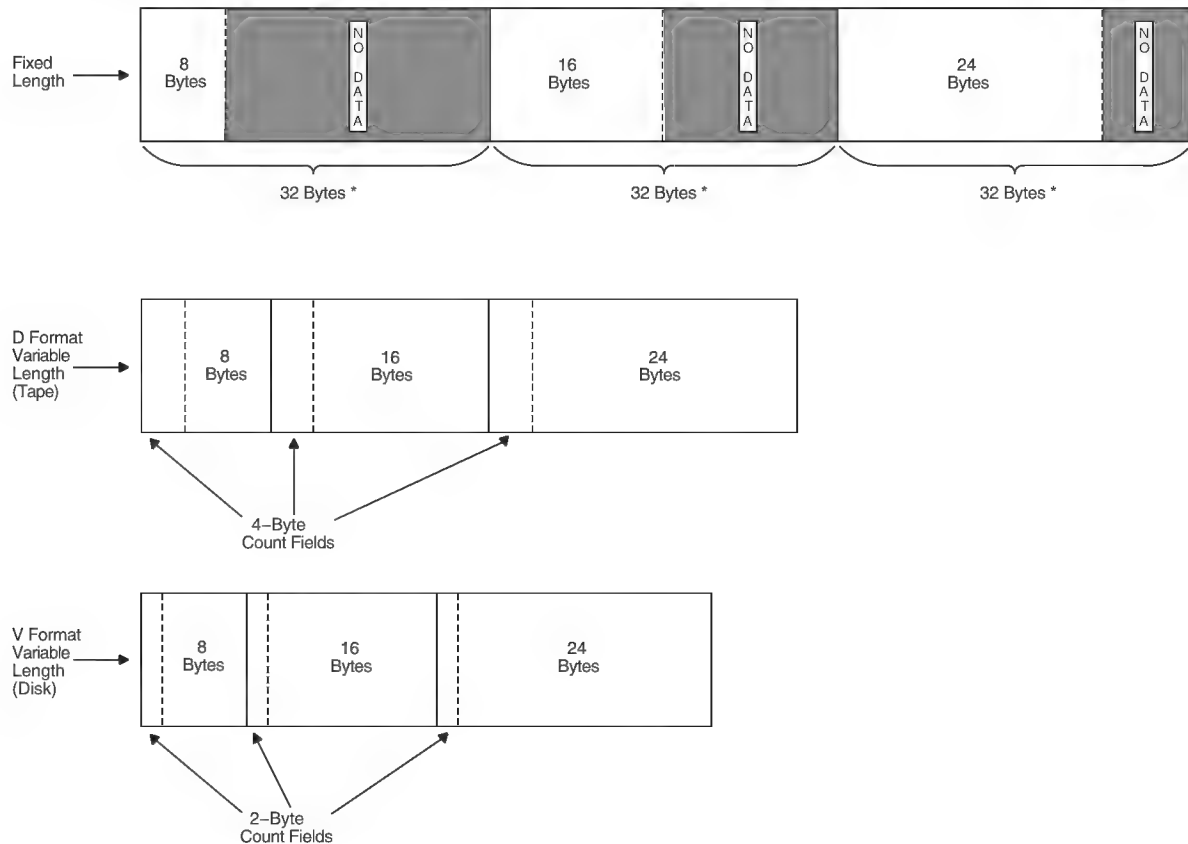

\* RMS considers all 32 bytes to be used, even though they may not contain useful information in the eyes of the user.

ZK-0754-GE

Clearly, variable-length records can save space; but if records are updated in place, you should consider trading off some space efficiency for update flexibility. All records in a relative file are in fixed-length cells. Here, variable-length records do not save space; in fact, the two count-field bytes prefixing each record actually consume additional space.

In the indexed file organization, the capacity of the data bucket and the maximum record size limit record length.

### 2.1.2.3 Variable-Length with Fixed-Length Control Field (VFC) Record Format

VFC records are similar to variable-length records except that a fixed-length control field is prefixed to the variable-length data portion. Unlike variable-length records, VFC records cannot be used in indexed files.

When you create a file for VFC records, you must specify the value (in bytes) of the longest record permitted in the file. If you accept the block span option (the default), the maximum VFC record size is 32767 bytes, less the number of bytes in the fixed-length control field. If you specify no block spanning, the maximum VFC record size is 510 bytes, less the number of bytes in the fixed-length control field. For additional information about selecting the block span option, see the *OpenVMS Record Management Services Reference Manual*.

Any attempt to store a record containing more bytes than the specified value results in an error. If you specify a value of 0, any length record can be stored.

## Choosing a File Organization

### 2.1 Record Concepts

You must also specify the value in bytes of the fixed-length control field. The fixed-length control field lets you include within the record additional data that may have no direct relationship to the other contents of the record. For example, the fixed-length control field may contain line-sequence numbers for every record in the file. The program does not use the line-sequence numbers, but they are helpful in locating records during file editing.

At the VAX MACRO level, you establish the length of the control field for VFC records using the FAB\$B\_FSZ field in the FAB. The Open, Create, and Display services provide the control field length in the XAB\$B\_HSZ field of the File Header Characteristic XAB. For more information, see the *OpenVMS Record Management Services Reference Manual*.

When writing a VFC record to a file, RMS merges the fixed-length control field with the variable-length record data and prefixes the merged record with the count field. Figure 2-7 shows how RMS writes a VFC record to a file.

Figure 2-7 Writing a VFC Record to a File

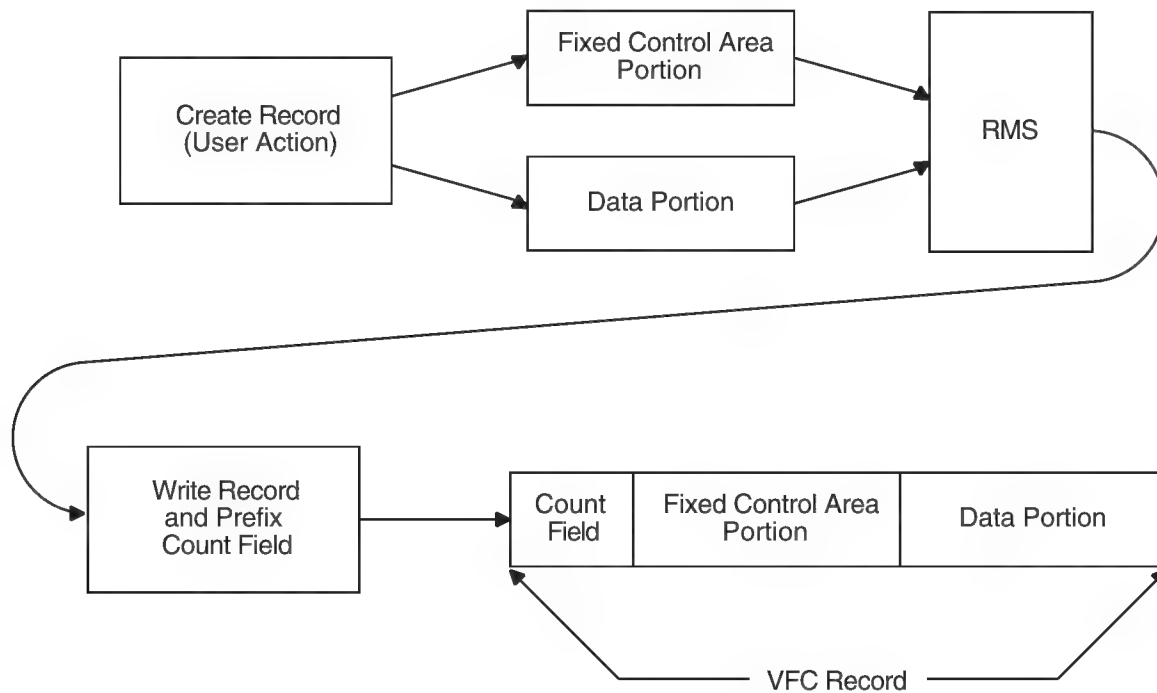

ZK-0755-GE

When RMS reads a VFC record, it uses the count field to determine the overall length of the record, and it uses the appropriate file attribute to determine the length of the control field. After subtracting the control-field length from the overall record length, RMS uses the result to separate the data from the control information. It then processes the data and stores the control information in a designated storage area for program use, if applicable. See Figure 2-8.

Figure 2–8 Retrieving a VFC Record

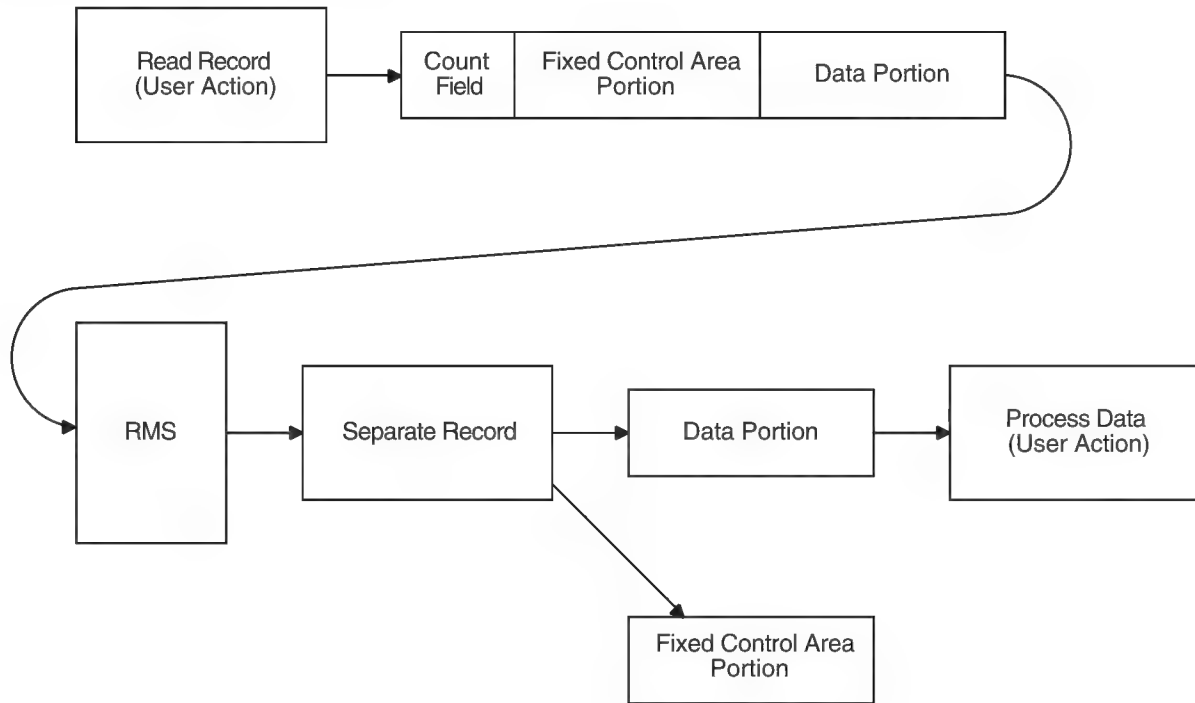

ZK-0756-GE

#### 2.1.2.4 Stream Record Format

There are four variations of stream record format. Special characters or character sequences called *terminators* delimit the records in files using the first three variations:

|           |   |
|-----------|---|
| STREAM_CR | This variation uses a carriage return as the terminator.  |
| STREAM_LF | This variation uses a line feed as the terminator.  |
| STREAM    | This variation ignores leading zeros and uses a terminator from a limited set of special characters: the line feed (LF), the carriage-return/line-feed combination (CR/LF), the form feed (FF), or the vertical tab (VT). |
| UNDEFINED | This variation has no terminator. The length of each record is determined by the size of the user buffer (maximum 65,535 bytes), or the end-of_file.  |

RMS supports the stream record format for sequential files on disk devices *only*. In a stream-formatted file, RMS treats the data as a continuous stream of bytes, without control information. Stream records are always permitted to span block boundaries.

## 2.2 File Organization Concepts

The terms *file organization* and *access mode* are closely related, but they are distinct from each other, nonetheless.

You establish the physical arrangement of records in the file—the file organization—when you create it. The organization of a file cannot be changed unless you use a utility conversion routine (such as the Convert utility) to create the file again with a different organization. Note that the Convert utility processes relative files by sequentially reading records from the input file, then

## Choosing a File Organization

### 2.2 File Organization Concepts

writing them to the output file. As a result, the relative record numbers (RRN) change when the input file contains deleted or unused records.

One of the file attributes you specify before creating a file is how records are inserted into it and subsequently retrieved from it—the access mode.

The terms *file organization* and *access mode* are sometimes confused because they share common elements. That is, files are *organized* sequentially, relative to some reference value, or by keyed index value. Similarly, a file may be *accessed* sequentially, relative to some reference value, or by using a keyed index value. The following sections emphasize the distinctions between the types of file organization.

Table 2–2 lists important features of each file organization.

**Table 2–2 File Organization Characteristics**

| Characteristics            | Sequential                    | Relative                  | Indexed                    |
|----------------------------|-------------------------------|---------------------------|----------------------------|
| <b>Medium</b>              |                               |                           |                            |
| Disk                       | Yes                           | Yes                       | Yes                        |
| Magnetic tape              | Yes                           | No <sup>1</sup>           | No <sup>1</sup>            |
| Unit record <sup>2</sup>   | Yes                           | No                        | No                         |
| <b>Record Formats</b>      |                               |                           |                            |
| Fixed-length               | Yes                           | Yes                       | Yes                        |
| Variable-length            | Yes                           | Yes                       | Yes                        |
| VFC (disk only)            | Yes                           | Yes                       | No                         |
| Stream (disk only)         | Yes                           | No                        | No                         |
| Undefined (disk only)      | Yes                           | No                        | No                         |
| <b>Overhead Per Record</b> |                               |                           |                            |
|                            | 0, 1, or 2 bytes <sup>3</sup> | 1 or 3 bytes <sup>4</sup> | 7 to 13 bytes <sup>5</sup> |
| <b>Record Operations</b>   |                               |                           |                            |
| Connect                    | Yes                           | Yes                       | Yes                        |
| Delete                     | No                            | Yes                       | Yes                        |
| Disconnect                 | Yes                           | Yes                       | Yes                        |
| Find                       | Yes                           | Yes                       | Yes                        |

<sup>1</sup>Although these file organizations are not compatible with magnetic tape operations, you may use magnetic tape to transport the files.

<sup>2</sup>Unit record devices include printers, terminals, card readers, mailboxes, and so forth.

<sup>3</sup>Fixed-length records and records with undefined format use no overhead; stream records use either 1 or 2 bytes of overhead; variable-length and VFC records use 2 bytes of overhead.

<sup>4</sup>Fixed-length records use 1 byte of overhead; variable-length records and VFC records use 3 bytes of overhead; extra overhead applies to each cell.

<sup>5</sup>Prolog 1 and Prolog 2 fixed-length records use 7 bytes of overhead. Prolog 1 and Prolog 2 variable-length records use 9 bytes of overhead. For Prolog 3, fixed-length records use 9 bytes of uncompressed overhead, and variable-length records use 11 bytes of uncompressed overhead. For key compression, add 2 bytes of overhead.

(continued on next page)

**Table 2–2 (Cont.) File Organization Characteristics**

| Characteristics          | Sequential                | Relative                 | Indexed     |
|--------------------------|---------------------------|--------------------------|-------------|
| <b>Record Operations</b> |                           |                          |             |
| Flush                    | Yes                       | Yes                      | Yes         |
| Free                     | Yes                       | Yes                      | Yes         |
| Get                      | Yes                       | Yes                      | Yes         |
| Rewind                   | Yes                       | Yes                      | Yes         |
| Truncate                 | Yes                       | No                       | No          |
| Update (disk only)       | Yes                       | Yes                      | Yes         |
| Put                      | Yes                       | Yes                      | Yes         |
| <b>I/O Unit</b>          |                           |                          |             |
|                          | 1 or more<br>blocks       | Bucket                   | Bucket      |
| <b>I/O Techniques</b>    |                           |                          |             |
| Deferred write           | Normal mode               | Selectable               | Selectable  |
| Multiblock count         | Yes                       | Bucket size              | Bucket size |
| Multiple access streams  | Yes                       | Yes                      | Yes         |
| Multiple buffers         | Yes                       | Yes                      | Yes         |
| Access sharing           | Read/write                | Read/write               | Read/write  |
| Other features           | Block-spanning<br>records | Maximum<br>record number | Areas       |

The next three sections describe file organizations.

### 2.2.1 Sequential File Organization

RMS supports the sequential file organization for all device types. It is the only organization supported for nondisk devices.

In sequential file organization, records are arranged one after the other in the order in which they are stored. For example, the fourth record is between the third and fifth records, as illustrated in Figure 2–9.

## Choosing a File Organization

### 2.2 File Organization Concepts

Figure 2–9 Sequential File Organization

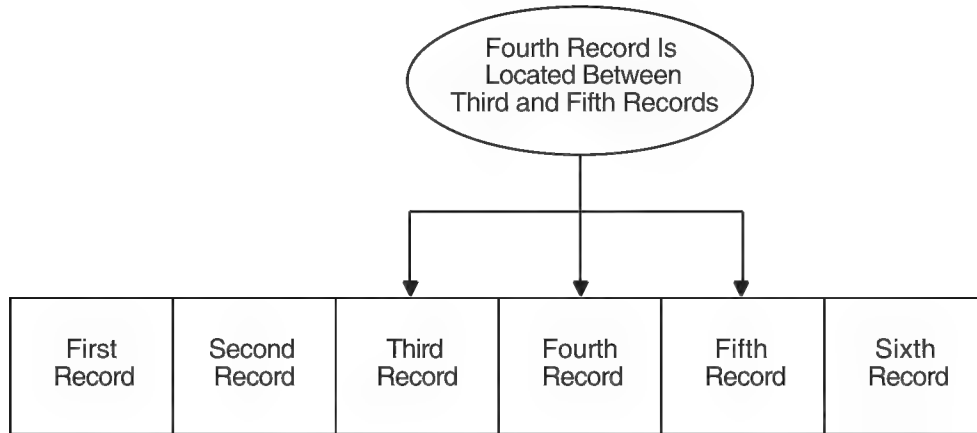

ZK-0742-GE

You cannot insert new records between existing records because no physical space separates them. Therefore, you can only add records to the current end of the file, that is, immediately following the most recently added record. For the same reason, you cannot add to the length of an existing record when updating it.

Some advantages and disadvantages of the sequential file organization are outlined in Table 2–3.

Table 2–3 Sequential File Organization: Advantages and Disadvantages

| Advantages  | Disadvantages   |
|---|---|
| Simplest organization   | To get a particular record, most higher-level languages must access all the records before it—no random access by key. <sup>1</sup> |
| Minimum overhead on disk  | Interactive processing is awkward; operator must wait as the program searches for a record.   |
| Allows block spanning   | You can add records only to the end of the file.  |
| Optimal if application accesses all records on each run   |   |
| Most versatile format: exchange data with systems other than RMS; compatible with ANSI magnetic tape format |   |
| No restrictions on the type of storage media; the file is portable  |   |
| Random access by key available on fixed-format disk sequential files  |   |

<sup>1</sup>This restriction does not apply to disk sequential files with fixed-length record format. Records in such files can be stored and retrieved using random access by key, depending on language capabilities.

### 2.2.2 Relative File Organization

The relative file organization allows sequential and random access of records on disk devices only.

---

**Note**

---

Although relative files are not supported for magnetic tape operations, magnetic tape can be used to transport relative files.

---

In fact, relative files provide the fastest random access, and they require fewer tuning considerations.

A relative file consists of a series of fixed-length record positions (or cells) numbered consecutively from 1 to  $n$  that enables RMS to calculate the record's physical position on the disk. The number, referred to as the **relative record number**, indicates the record cell's position relative to the beginning of the file.

RMS uses the relative record number as the key value to randomly access records in a relative file. The preferred method of tracking relative record numbers is to assign them based on some numeric field within the record, for example, the account number.

See Section 2.1.1.2 for a description of random access by key.

Each record in the file may be randomly assigned to a specific cell. For example, the first record may be assigned the first cell and the second record may be assigned the third cell, leaving the second cell empty. Unused cells and cells from which records have been deleted may be used to store new records.

Figure 2–10 illustrates the relative file organization.

**Figure 2–10 Relative File Organization**

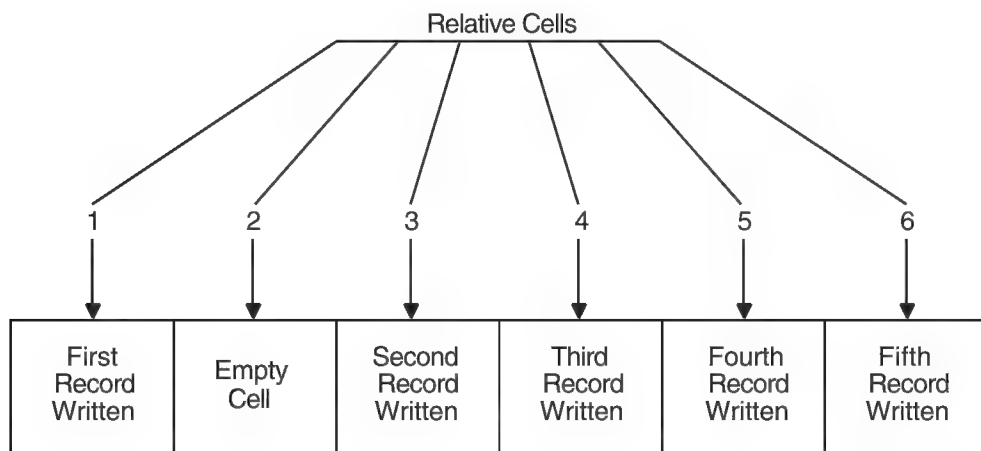

ZK-0743-GE

In a relative file, the actual length of the individual records may vary (that is, different size records can be in the same file) up to the limits imposed by the specified cell length. For example, think of a relative file configured as shown in Figure 2–11.

## Choosing a File Organization

### 2.2 File Organization Concepts

Note that because the records are variable-length records, each is prefixed by 3 bytes: the 2-byte count field (described in Section 2.1.2.2) and a 1-byte field that indicates whether or not the cell is empty (a delete flag). These bytes are used only by RMS—you need not be concerned with them, except when planning the file's space requirements.

**Figure 2–11 Variable-Length Records in Fixed-Length Cells**

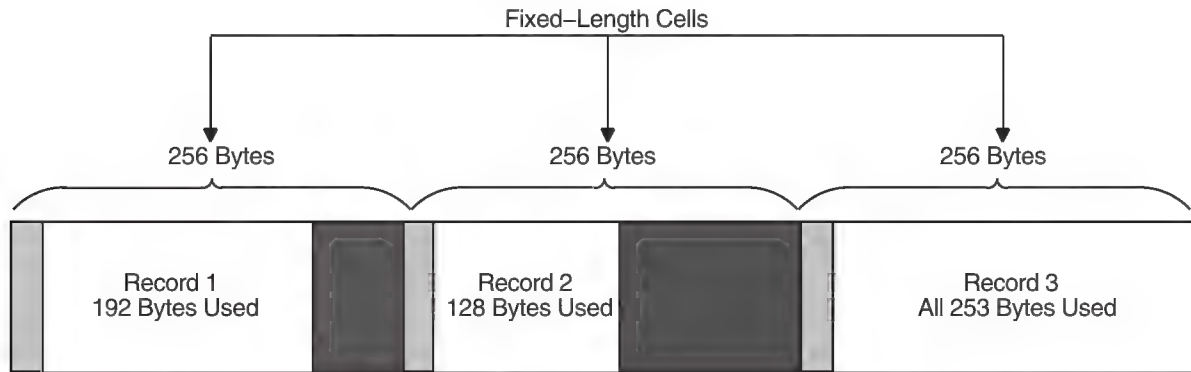

Legend:



= RMS Control Information Bytes



= Unused Bytes

ZK-0744-GE

Some advantages and disadvantages of relative file organization are outlined in Table 2–4.

**Table 2–4 Relative File Organization: Advantages and Disadvantages**

| Advantages                                     | Disadvantages  |
|--|--|
| Random access in all languages                 | Restricted to disk devices.  |
| Allows deletions                               | File contains a cell for each cell number between first and last record in file; limits data density.                                      |
| Allows random Get and Put operations           | Program must know relative record number or RFA before it can randomly access the data; no generic access as in indexed file organization. |
| Random and sequential access with low overhead | Interactive access can be awkward if you do not access records by relative record number.  |
| Can be write-shared                            | You can only insert records into unused record cells, but you can update existing records.   |

(continued on next page)

Table 2–4 (Cont.) Relative File Organization: Advantages and Disadvantages

| Advantages | Disadvantages  |
|------------|--|
|            | RMS does not allow duplicate relative record numbers.                    |
|            | The space taken up by each record is as long as the maximum record size. |

### 2.2.3 Indexed File Organization

The indexed file organization allows sequential and random access of records on disk devices only. This type of file organization lets you store data records in an index structure ordered by the primary key and retrieve data using index structures ordered by primary or alternate keys. The alternate index structures do not contain data records; instead, they contain pointers to the data records in the primary index.

For example, an indexed file may be ordered in ascending sort order by the primary key “employee number.” However, you may want to set up additional (alternate) indexes for retrieving records from the file. Typically, you might set up an alternate index in descending sort order by each employee’s social security number.

---

**Note**

---

The physical location of records in an indexed file is transparent to your program because RMS controls record placement.

---

In addition to the indexes, each indexed file includes a prolog structure that contains information about the file, including file attributes. RMS currently supports three distinct prologs—Prolog 1, Prolog 2 and Prolog 3—but RMS normally creates a Prolog 3 indexed file. However, you can specify a previous prolog version, typically for compatibility with RMS–11.

#### 2.2.3.1 Sequentially Retrieving Indexed Records

To sequentially retrieve indexed records, your program must specify the key for the first access. RMS then uses the index for that key to retrieve successive records. For example, assume an index file with three records, having primary keys of A, B, and C, respectively. To retrieve these records sequentially in ascending sort order, your program must provide the key A on the first access; RMS accesses the next two records without further key inputs from your program.

To randomly retrieve records in an index file, your program must provide the appropriate key value for each access. Now assume an index file with three records having primary keys A, B, and C that are retrieved in C, A, B order. On the first access, your program must provide the key C, on the next access the key A, and on the final access the key B.

## Choosing a File Organization

### 2.2 File Organization Concepts

#### 2.2.3.2 Index Keys

In an indexed file, each record includes one or more key fields (or simply keys) that RMS uses to build related indexes. Each key is identified by its location, its length, and whether it is a simple or a segmented key.

A simple key may be any one of the following data types:

- A single contiguous character string
- A packed decimal number
- A 2-, 4-, or 8-byte unsigned binary number
- A 2-, 4-, or 8-byte signed integer

---

#### Note

---

RMS-11 cannot process 8-byte numeric keys.

---

Segmented keys are fields of character strings having from 2 to 8 segments that may be or may not be contiguous; however, RMS treats all key segments as a logically contiguous string. Segmented keys enhance flexibility in manipulating data files by letting you select the placement of data fields and then tailoring the key structure to fit this layout. You can improve performance by defining a segment that contains the desired key together with another segment that contains a unique field, thereby making the entire key unique. When only noncontiguous portions of a text string are needed for a key, you can improve efficiency by defining smaller keys that include only these segments.

For an indexed file, you must define at least one key, the primary key, and you can optionally define one or more alternate keys. RMS uses alternate keys to build indexes that identify records in alternate sort orders. As with the primary key, each alternate key is defined by location and length.

#### 2.2.3.3 Other Key Characteristics

In addition to defining keys, you can specify various key characteristics (FDL secondary key attributes) including the following:

|                 |  |
|-----------------|--|
| Duplicate keys  | This characteristic permits you to use the key value in more than one record. However, only the first record having the key value can be accessed randomly; other records having the same key value can be accessed only sequentially.   |
| Changeable keys | This characteristic applies to alternate keys only. When you specify <i>changeable</i> alternate keys, the <i>alternate</i> keys in a record can be changed when the record is updated. When an alternate key value changes, RMS automatically adjusts the appropriate index to reflect the new key value. |
| Null keys       | This characteristic applies to alternate keys only. When you fill an alternate key field with null characters, RMS does not insert the record in the related index.  |

---

#### Note

---

RMS excludes from the related index any record not long enough to contain a complete alternate key.

---

Key characteristics can be defined separately for each key.

## Choosing a File Organization

### 2.2 File Organization Concepts

When you do not allow duplicate key values, RMS rejects any attempt to put a record into a file if it contains a key value that duplicates a key value already present in another record. Similarly, when alternate key values cannot be changed, RMS does not allow your program to update a record by changing the alternate key value. If you disallow a null value for a key, RMS inserts an entry for the record in the associated alternate index.

Figure 2–12 illustrates the general structure of an indexed file containing only a primary key: the employee name in an employment record file. Figure 2–13 illustrates the general structure of an indexed file in which the primary key and one alternate key are defined. The primary key is the name of the employee; the alternate key is the employee badge number in an employment record file.

# Choosing a File Organization

## 2.2 File Organization Concepts

Figure 2-12 Single-Key Indexed File Organization

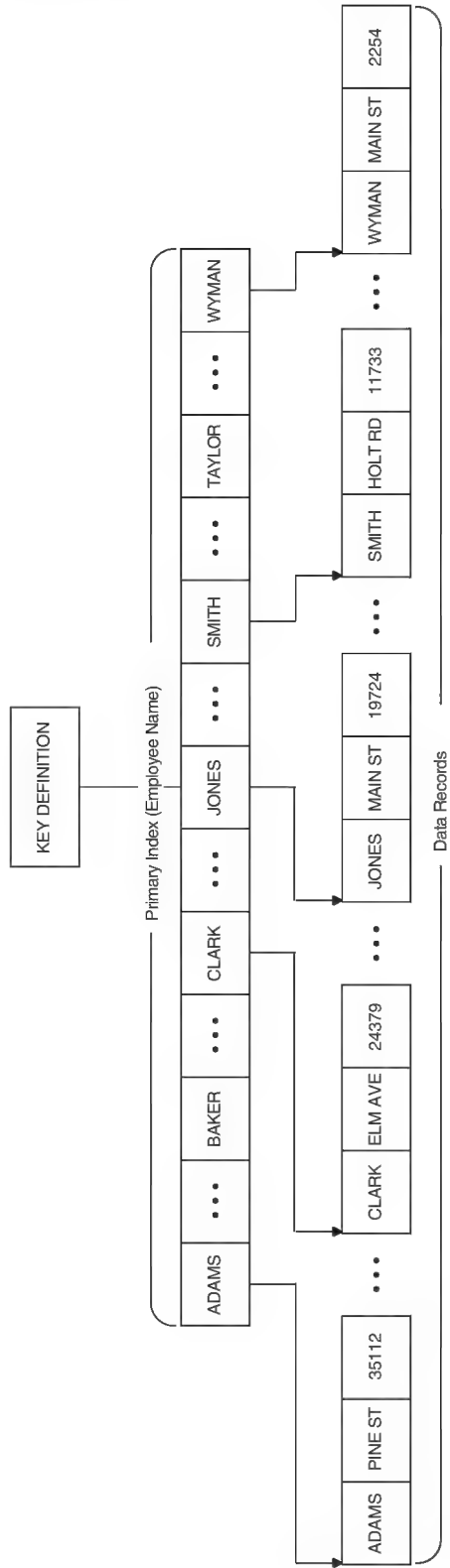

Note: Assumes one record per bucket.

ZK-0745-GE

Figure 2-13 Multiple-Key Indexed File Organization

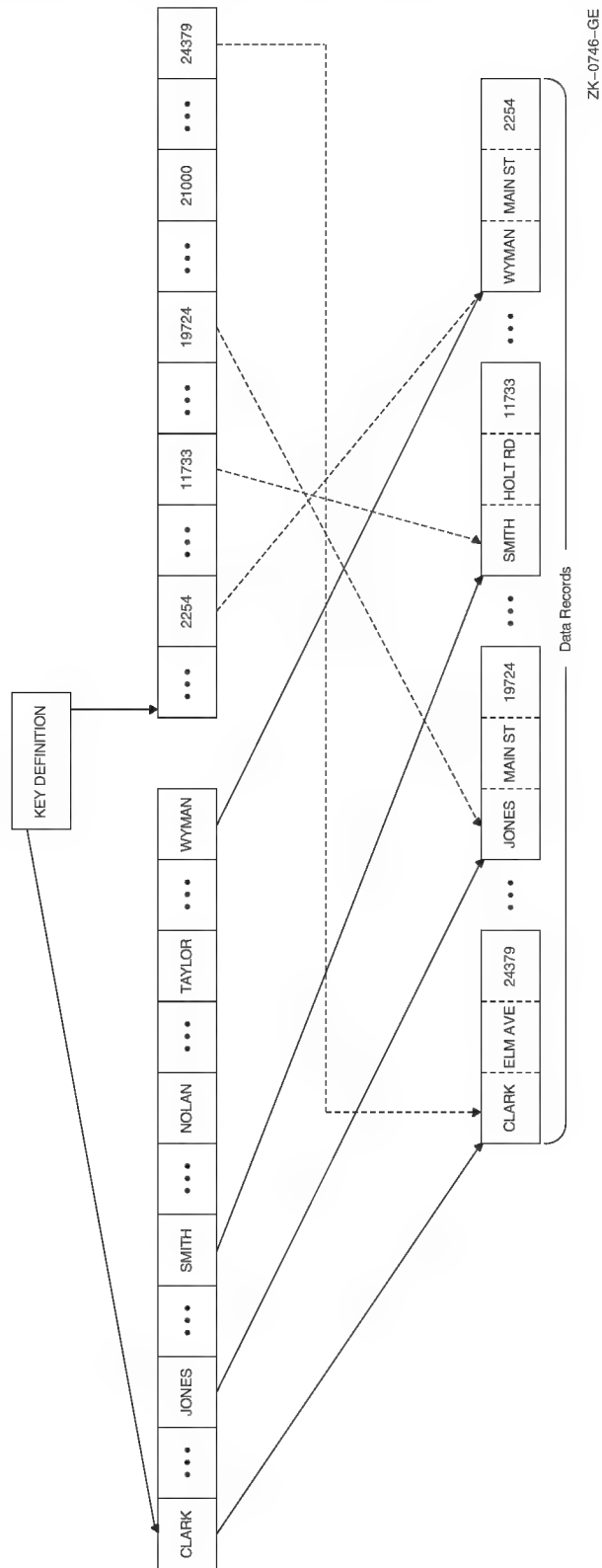

## Choosing a File Organization

### 2.2 File Organization Concepts

#### 2.2.3.4 Specifying Sort Order

RMS lets you specify either ascending sort order or descending sort order for each key. At the VAX MACRO level, you encode sort order within the key data type field (XAB\$B\_DTP) of the associated key XAB; you use the attribute KEY TYPE at the FDL level. For example, if you want to build an index of string data type keys in ascending sort order using VAX MACRO, you enter the following line in the associated key XAB:

```
DTP = STG
```

To build an index of string data type keys in descending sort order, you enter this line in the associated key XAB:

```
DTP = DSTG
```

See the *OpenVMS Record Management Services Reference Manual* for a complete listing of key data types used to specify ascending and descending sort order.

#### 2.2.3.5 Using Collated Keys

The RMS multinational key feature lets you assign alternative (non-ASCII) collating sequences to a key. For example, a program can sort records using a key that accesses a collating sequence based on French or alternatively accesses a collating sequence based on Spanish.

The basis for this feature is the National Character Set utility (NCS). When an application program creates an index file with an alternative collating sequence, it calls NCS. NCS responds by retrieving the collating sequence from the NCS library, storing it in local memory and providing the calling program with a pointer to it. In addition to naming the collating sequence, the calling program must provide NCS with a location for storing the pointer (CS\_ID) to the memory location of the collating sequence. (For information about NCS, see the *OpenVMS National Character Set Utility Manual*.)<sup>1</sup>

When the application program creates the data file, it uses the pointer to copy the collating sequence from local memory into the data file's prolog space. A collating sequence is typically 1 block long.

The application program may specify a collated key from either the RMS interface or the FDL interface.

From the RMS interface, the application program identifies the collating sequence using an appropriate string descriptor and includes a symbolic reference to the location of the pointer. As with all other keys, the application program may specify either ascending or descending sort order. From the RMS interface, you specify the key data type COL for an ascending sort order or the key data type DCOL for descending sort order.

From FDL, you specify a collated key by selecting one of the collated key data types (collated for ascending sort order, decollated for descending sort order) from the INDEXED file script. FDL responds by prompting for the name of the collating sequence. If you enter an invalid collating sequence, any attempt to use the FDL file for creating a data file will be unsuccessful, and NCS generates the following error message:

---

<sup>1</sup> This manual has been archived but is available on the OpenVMS Documentation CD-ROM. A printed book can be ordered by calling 800-282-6672.

## Choosing a File Organization

### 2.2 File Organization Concepts

%NCS-F-NOT\_CS, name or id is not a CS

Example 2-1 illustrates the use of collated keys in a MACRO-32 program segment.

#### Example 2-1 Creating a File Containing Collated Keys

```
.
.
.
.      .TITLE Example
;
; Define key type as COL or DCOL
;
KEY0:  $XABKEY
.
.
.      DTP=COL
;
; Descriptor for collating sequence name
;
CS_DESC:      .ASCID /Spanish/
              .EXTRN NCS$GET_CS
.
.
; Collating sequence name descriptor
;
              PUSHAL  CS_DESC
;
; Where to store address of collating sequence
;
              PUSHAL  KEY0+XAB$L_COLTBL
;
; Fetch collating sequence
;
              CALLS   #2,G^NCS$GET_CS
              BLBC    R0,ERROR
;
; Create file
;
              $CREATE FAB=OUTFAB
              BLBC    R0,ERROR
```

#### 2.2.3.6 Summary of Indexed File Organization

Some advantages and disadvantages of the indexed file organization are outlined in Table 2-5.

**Table 2-5 Indexed File Organization: Advantages and Disadvantages**

| Advantages  | Disadvantages                          |
|---|--|
| Most flexible random access: by any one of multiple keys or RFA; key access by generic or approximate value | Highest overhead on disk and in memory |

(continued on next page)

## Choosing a File Organization

### 2.2 File Organization Concepts

**Table 2–5 (Cont.) Indexed File Organization: Advantages and Disadvantages**

| <b>Advantages</b>   | <b>Disadvantages</b>        |
|---|-----------------------------|
| Duplicate key values possible   | Restricted to disk          |
| Automatic sort of records by primary and alternate keys; available during sequential access | Most complex programming    |
| Record location is transparent to user  | Longest record access times |
| Potential range of key values not physically present as in relative file organization       |                             |
| Variety of data formats for keys  |                             |
| Transparent data compression  |                             |

---

## Performance Considerations

When you design a file, your decisions regarding record access mode, record format, and file organization should be aimed at achieving optimum data processing performance for your application. This chapter discusses general performance considerations and specific trade-offs you can make in the design of your data files. In Section 3.3, Section 3.4, and Section 3.5, these trade-offs are discussed in the contexts of the three file organizations: sequential, relative, and indexed.

### 3.1 Design Considerations

In designing files for optimum data processing performance, you should emphasize the following performance factors:

- **Speed**—You want to maximize the speed with which your program processes data.
- **Space**—You want to minimize the space required to store data on disk and to process data in memory.
- **Shared access**—You want your data to be simultaneously accessible to authorized users.
- **Impact on application design**—You want to minimize the application design effort.

#### 3.1.1 Speed

The first guideline you can apply to the design process is to decrease the amount of program I/O time.

Storing data on, and retrieving data from, mass storage devices is the most time-consuming OpenVMS RMS (hereafter referred to as RMS) operation. For example, when an application needs data, the disk controller must first search for the data on the disk. The disk controller must then transfer the data from the disk to main memory. After processing the data, the program must provide for returning the results to mass storage via the I/O subsystem.

One way to reduce I/O time is to have the data in memory so that you can minimize search and transfer operations. If data must be transferred to memory for processing, you should consider design variables that reduce transfer time.

The first variable you might consider is the set of *file attributes* that may affect I/O time:

- Initial file allocation
- Default extension quantity
- Bucket size (for a relative or indexed file)

## Performance Considerations

### 3.1 Design Considerations

- Number of keys (for an indexed file)
- Number of duplicate key values (for an indexed file)

The second variable is the *file size* as measured by the number of records in the file. File size affects the time it takes to scan a file sequentially or to access records using an index.

A third variable is the *storage device* on which your program and data files reside. Crucial to I/O performance are the type of device chosen (moving-head, fixed-head, and so on) and the amount of I/O activity for that device within the system.

To make your applications run faster, consider the following:

- Keep as much data in memory as possible, but be wary of any significant increase in the page fault rate.
- Minimize the number of I/O transfers by transferring larger portions of data.
- Arrange your data on the disk to minimize disk head motion.

#### 3.1.2 Space

When you run your application, you need space to buffer data in memory. You can reduce data processing time by increasing the size of the I/O buffers RMS uses; however, avoid exceeding the space limitations imposed by the working set.

In addition to the data buffers themselves, the space required to store data can vary depending on the file organization you choose.

For example, sequential file organization requires RMS to add an empty byte to a record when the record has an odd number of bytes but must be aligned on an even-numbered byte boundary. At the record level, you should consider the added space required to prefix a two-byte count field to each variable-length record.

For the relative file organization, RMS constructs a series of record storage cells based on the maximum length of the records. The record cells are 1 byte longer than the size of fixed-length records or 3 bytes longer than the maximum size specified for variable-length records.

For the indexed sequential file organization, RMS must add the following informational components to your data files:

- An index for each defined key.
- 15 bytes of formatting information for each bucket.
- A 7-byte header for each record.
- A count field for each variable-length record.
- Other overhead of varying lengths that is needed by RMS to move files and to delete records. You should keep the size of records to the minimum required for your application.

You should also consider the effects of compression on the size of your indexed files. You can compress keys in data buckets and in index buckets, and you can compress data in the primary buckets. If you use key, index, or data compression, the file requires less space on the disk, and each I/O buffer can hold more information. Compression may even eliminate one index level thereby reducing the number of disk transfers needed for random access.

---

**Note**

---

You cannot use key compression or index compression with the collated key data type.

---

Random access of compressed files requires slightly more CPU time, but this is usually offset by the improved performance you achieve with fewer index levels.

### 3.1.3 Shared Access

A file management technique that allows more than one user to simultaneously access a file or a group of files is called *shared access* or *file sharing*. When you try to adjust the performance of shared files, you need to pay particular attention to record locking options and the use of global buffers. Avoid assigning sharing attributes to files that are not actually shared.

There are essentially three sharing conditions: no sharing, sharing without interlocking, and sharing with interlocking. Chapter 7 discusses each of these in detail.

### 3.1.4 Impact on Applications Design

The impact on applications design increases as file design complexity increases. That is, your application programs require more design effort for processing indexed files than for processing sequential files. The primary consideration here should be to evaluate whether the benefits derived by having direct access to records is worth the added cost of the application program design needed to interface with the file management system.

## 3.2 Tuning

The process of designing your files to achieve better processing performance is called *tuning*.

Tuning requires you to make a number of trade-offs and design decisions. For example, if a process had sole access to the processor, it could keep all of its data in memory and tuning would be unnecessary, but this situation is unlikely. Instead, several processes are usually running simultaneously and are competing for the memory resource. If all processes demand large amounts of memory, the system responds by paging and swapping, which slows down system performance.

The way you intend to use your programs and data files can determine some of the basic tuning decisions. For example, if you know that three files are accessed 80 percent of the time, you might consider locating the files in a common area on the disk to speed up access to them. The performance of programs that use the other files is slower, but the system as a whole runs faster.

In tuning your file management system, you implement these trade-offs and design decisions by specifying file design attributes together with various file-processing options and record-processing options.

## Performance Considerations

### 3.2 Tuning

#### 3.2.1 File Design Attributes

The following file design attributes control how the file is arranged on the disk and how much of the file is transferred to main memory when needed. These file design attributes generally apply to all three types of file organization; other file design attributes that specifically pertain to the various file organizations are described under the appropriate heading.

- Initial file allocation
- Contiguity
- File extend quantity
- Units of I/O
- The use of multiple areas (for indexed files)
- Bucket fill factor (for indexed files)

The following sections discuss how each file design attribute can maximize efficiency.

##### 3.2.1.1 Initial File Allocation

When you create a file, you should allocate enough space to store it in one contiguous section of the disk. If the file is contiguous on the disk, it requires only one retrieval pointer in the header; this reduces disk head motion.

You should also consider allocating additional space in anticipation of file growth to reduce the number of required extensions.

You can allocate space either by using the FDL attribute `FILE ALLOCATION` or by using the file access control block field `FAB$L_ALQ`.

##### 3.2.1.2 Contiguity

Use the `FILE` secondary attribute `CONTIGUOUS` to arrange the file contiguously on the disk, if you have sufficient space. If you assign the `CONTIGUOUS` attribute and there is not enough contiguous space on the disk, RMS does not create the file. To avoid this, consider using the FDL attribute `BEST_TRY_CONTIGUOUS` instead of the `CONTIGUOUS` attribute. The `BEST_TRY_CONTIGUOUS` attribute arranges the file contiguously on the disk if there is sufficient space or noncontiguously if the space is not available for a contiguous file.

You can make this choice by accepting the FDL default values for both attributes—`NO` for `CONTIGUOUS`, `YES` for `BEST_TRY_CONTIGUOUS` or by taking the RMS `FAB$V_CBT` option in the `FAB$L_FOP` field.

##### 3.2.1.3 Extending a File

An extend operation (file extend) adds unused disk blocks to an RMS file when the free space within a file is exhausted. If the unused disk blocks are not contiguous to the previously allocated disk blocks of the file, the file becomes fragmented. As a file becomes fragmented, access time increases and processing performance can degrade. Appropriate use of extend operations can minimize file fragmentation.

If you intend to add large amounts of data to a file over a short time, using large extends will minimize file fragmentation and the overhead of extend operations. Conversely, if you intend to add small amounts of data to a file over a long time, smaller file extends can avoid wasted disk space.

There are two methods for extending files. One method is for an application program to call the \$EXTEND service (see the *OpenVMS Record Management Services Reference Manual* for details). When it calls the \$EXTEND service, the application must specify an explicit extend size, in disk blocks, because no defaults are used to determine the extend size.

The other method is for RMS to automatically extend (auto extend) a file when free space is needed. You can specify the size of auto extends using various default extension quantities, or you can have RMS supply a default extend size. However, when RMS supplies a default, it uses an algorithm that allocates a minimal extend. Repeated minimal extends can increase file fragmentation.

**3.2.1.3.1 Auto Extend Size Selection** This section describes the factors used to determine the size of auto extends. These include:

- File organization (sequential, relative, and indexed)
- Type of access (record I/O or block I/O)
- Various default extension quantities

The remainder of this section describes how to use the various default extension quantities to select the auto extend size for all file organizations and access types. Manipulating the various default extension quantities is described in Section 3.2.1.3.2.

#### **Sequential File and Block I/O Accessed File Extend Size**

The auto extend size used for sequential files is also used for all file organizations when accessed by block I/O. The extend size is selected from the following ordered list of default extension quantities. Generally, if a default extension quantity does not exist, it is set to zero. RMS processes this list until it finds a nonzero value.

- File default extension quantity
- Process default extension quantity
- System default extension quantity

Note that, if the selected value from this list is any value but the file default extension quantity, the selected value is maximized against the volume default extension quantity. In the case of a device-full error, RMS retries the extend requesting the minimum number of blocks to satisfy the user's write request. No retries are done if a disk quota is exceeded; a quota exceeded error is returned.

#### **RMS Supplies a Minimal Extend Size**

RMS supplies a minimal extend size that is the smaller of twice the buffer size or 256. The buffer size in this calculation depends on the type of file access. If the file is a sequential file that is opened for record I/O access, RMS uses the multiblock count. If the file is opened for block I/O access (regardless of organization), RMS uses the size of the user buffer supplied by the application to the \$WRITE service.

#### **Relative File Extend Size**

A relative file can be viewed as an accessible series of fixed-sized cells (or records) ranging from one to the maximum number of cells. Writing new cells that are located substantially beyond the allocated space of the relative file is permitted.

## Performance Considerations

### 3.2 Tuning

The size of a relative file auto extend is initially set to the minimum number of disk blocks that must be allocated to reference the new cell. The extend size is then rounded to the next bucket boundary so that the entire bucket containing the new record can be accessed. This value is then maximized against the file default extension quantity. If no file default exists, this value is maximized against the volume default extension quantity.

The process and system default extension quantities are not applicable to auto extending a relative file.

#### Indexed File Extend Size

Indexed files are auto extended by adding space to a particular area of the indexed file. The extend size is always rounded to a multiple of the bucket size for the area being extended.

- If the area being auto extended had an area default extension quantity specified when the indexed file was created (or converted using an FDL), that quantity is used for the extend size.
- If no area default extension quantity exists, the file default extension quantity is used for the extend size.
- If no area or file default extension quantities are specified, RMS auto extends the area by one bucket.

The process, system, and volume default extension quantities are not applicable to auto extending an indexed file.

**3.2.1.3.2 Establishing Auto Extend Default Quantities** This section describes how to establish the auto extend default quantities for an RMS file.

#### Area and File Default Extension Quantities

You can establish a file-specific default, called the file default extension quantity, for all file organizations. In the case of an indexed file with multiple areas, you can also establish a separate area default extension quantity for each area of the indexed file.

The following list describes the methods for establishing file default extension quantities, and, where applicable, area default extension quantities:

- The recommended method is to use the Edit/FDL utility to permanently establish file and area default extension quantities when you create or convert a file. The Edit/FDL utility calculates these quantities using your responses to the script questions, and it assigns the file default extension quantity using the FILE EXTENSION attribute. For indexed files with multiple areas, the Edit/FDL utility assigns a default extension quantity to each area using the AREA EXTENSION attribute. A subsequent \$CREATE service or use of the CONVERT utility using an FDL with these EXTENSION attributes permanently sets these defaults. For a description of how the Edit/FDL utility calculates default extension quantities, see Appendix A.
- One alternative to using the Edit/FDL utility is to permanently establish the file and area default extension quantities by specifying the appropriate values in the FAB (or XABALL) used as input to the \$CREATE service.

The FAB\$W\_DEQ field defines the file default extension quantity. For indexed files with multiple areas, individual area XABALLs (with the XAB\$B\_AID field and the related XAB\$W\_DEQ field set appropriately) establish area default extension quantities.

If you use this method, you can determine the default extension quantities using file and area-specific information such as the average record size, the number of records to be added to the file during a given period of time, the number of records per bucket and the bucket size.

When both a FAB and a XABALL are present on the opening or creation of an RMS file, the XABALL fields override equivalent FAB fields. If the XABALL is present, then the file default extension quantity is set from the XAB\$W\_DEQ, overriding any value in the FAB\$W\_DEQ field. In the case of an indexed file with multiple areas where multiple XABALLs might exist, the file default extension quantity is set to the default extension quantity for Area 0.

A single allocation XAB (XABALL) can also be specified on the creation of a relative or sequential file. However, there is no separate area default extension quantity maintained for these files. The XABALL is used in this case to establish the file default extension quantity in one of the following ways:

- After a file has been created, specifying the file default extension quantities (FAB\$W\_DEQ) on input to a \$OPEN establishes a temporary file default extension quantity that overrides any permanent setting that might exist. This temporary default is used when you access the file until the file is closed.

Note that the area default extension quantities for an indexed file specified on a \$CREATE cannot be changed over the lifetime of the file nor can they be overridden at run time.

- Once a file has been created, you can change or establish the permanent file default extension quantity by using the DCL command SET FILE/EXTENSION=*n*, where *n* is the extension quantity in disk blocks for the file. The next time the file is opened, it uses the new default quantity.

In addition to the file and area default extension quantities, there are process, system, and volume default extension quantities.

#### Process Default Extension Quantity

The process default extension quantity is established by the DCL command SET RMS\_DEFAULT/EXTEND\_QUANTITY=*n*, where *n* is the extension quantity. This default applies only to the process issuing this DCL command and remains in effect only until the process is deleted.

#### System Default Extension Quantity

The system default extension quantity is established by the SET RMS\_DEFAULT/SYSTEM/EXTEND\_QUANTITY=*n* command. Note that you need the CMKRNL privilege to use the /SYSTEM qualifier. This default applies to all processes on a node in the cluster. When you use this DCL command to establish the system default extension quantity, it remains in effect until the node is rebooted.

You can also establish the system default extension quantity in a temporary or permanent fashion by appropriately setting the SYSGEN system parameter RMS\_EXTEND\_SIZE.

## Performance Considerations

### 3.2 Tuning

#### Volume Default Extension Quantity

The volume default extension quantity can be permanently established when the volume is initialized with the INITIALIZE/EXTENSION=*n* command. This default quantity is used whenever the volume is mounted. To permanently change the volume default extension quantity, you can use the SET VOLUME/EXTENSION=*n* command on a mounted disk. To temporarily establish a volume default extension quantity or temporarily override the permanent volume default extension quantity, use the MOUNT/EXTENSION=*n* command. The new default is in effect until the volume is dismounted. Unlike the other default quantities described that default to zero if not specified, the volume default extension quantity defaults to 5 if not specified.

**3.2.1.3.3 Placement and Contiguity of Extends** In addition to specifying the size of an extend, you can specify other characteristics that affect the placement and contiguity of the extend.

When an application extends a file by calling the \$EXTEND service, an Allocation XAB (XABALL) can be used to place an extend on a particular disk block or disk cylinder. If no allocation XAB is present on the \$EXTEND and the FAB contiguity options (described later in this section) are not selected, RMS automatically places the extend near the last allocated disk block in the file. If the file being extended in this fashion is an indexed file opened for record I/O access, RMS adds the new disk space as near as possible to the last allocated disk block in the area being extended. This technique groups disk blocks belonging to the same area of the indexed file.

When RMS automatically extends a file, the application cannot control placement; however, RMS uses placement controls in one of the following ways, depending on how the file is organized:

- When automatically extending an indexed file, RMS uses placement control to allocate the new disk space as close as possible to the last allocated disk block of the indexed file area being extended.
- When automatically extending a relative file, RMS uses placement control to allocate the new disk space as close as possible to the last allocated disk block of the file.
- No placement control is used when RMS automatically extends a sequential file or any file organization accessed for block I/O.

An extend is considered contiguous if all the disk blocks of the extend are physically adjacent on the disk. There are two types of contiguous extend requests that can be made. The first, called a **contiguous request**, returns an error if contiguous disk blocks cannot be found to satisfy the request. The second, called a **contiguous best try request**, attempts to find contiguous disk blocks for the request. If it does not find sufficient contiguous space, it extends the file and does not return an error. The contiguity options can be input to an \$EXTEND service in the FAB (FAB\$V\_CBT, FAB\$V\_CTG) or in the Allocation XAB (XAB\$V\_CBT, XAB\$V\_CTG). The Allocation XAB settings override any FAB settings.

When RMS automatically extends a file, the application can only indirectly control contiguity by setting the FAB or XABALL contiguity bits on input to the \$CREATE service. Once set on file creation, these options are available for subsequent extends done automatically by RMS.

Note that setting the FAB\$V\_CTG bit could cause an extend to fail on a sufficiently fragmented disk. Note too, that the FAB\$V\_CBT option is disabled after several failures to allocate contiguous disk space to avoid the expensive overhead of contiguous best try processing on a badly fragmented disk.

#### 3.2.1.4 Truncating a File

Only RMS sequential disk files that have been opened for write access (FAB\$V\_PUT, FAB\$V\_UPD, FAB\$V\_DEL or FAB\$V\_TRN) can be truncated. This applies to unshared and shared sequential files.

Two types of truncation can occur on RMS sequential files: RMS truncation and Ancillary Control Procedure (ACP) truncation.

RMS truncation involves resetting the end-of-file (EOF) pointer back to a previous position (possibly the beginning) of a sequential file to reuse the allocated space in a file. RMS truncation is described in the *OpenVMS Record Management Services Reference Manual* under the \$TRUNCATE service.

ACP truncation occurs when RMS closes a sequential file and requests that the ACP deallocate all disk blocks allocated beyond the EOF of the file. The primary use of ACP truncation is to conserve disk space. The remainder of this section deals with ACP truncation.

You can also use ACP truncation in conjunction with large extend sizes to reduce disk fragmentation. If a file is growing slowly over time, the application can allocate the largest possible extend, and when finished, it can use ACP truncation to deallocate any unused space at the end of the sequential file. However, if a sequential file is continually growing, excessive ACP truncation can lead to an increase in disk fragmentation resulting in more CPU and I/O overhead.

ACP truncation can be requested directly by way of the programming interface by setting the FAB\$V\_TEF bit on input to the \$OPEN, \$CREATE, or \$CLOSE service. The ACP truncation occurs on the close of the sequential file. Note that ACP truncation can occur on shared as well as unshared sequential files. If there are shared readers of the file, ACP truncation is postponed until the last reader of the file closes the file. If there are other writers of a shared sequential file, then ACP truncation requests are ignored. However, the ACP truncation request of the last writer to close the file will be honored.

ACP truncation of a sequential file can be automatically requested by RMS if an auto extend has been done during this file access and no file default extend quantity exists to be used for the auto extend. Using ACP truncation in this instance avoids wasting space when auto extending with a less precise extend quantity default, such as the system default extend quantity.

#### 3.2.1.5 Units of I/O

Another file design consideration is to reduce the number of times that RMS must transfer data from disk to memory by making the I/O units as large as possible. Each time RMS fetches data from the disk, it stores the data in an I/O memory buffer whose capacity is equal to the size of one I/O unit. A larger I/O unit makes more records immediately accessible to your program from the I/O buffers.

In general, using larger units of I/O for disk transfers improves performance, as long as the data does not have to be swapped out too frequently. However, as the total space used for I/O buffers in the system approaches a point that results in excessive paging and swapping, increasing I/O unit size degrades system performance.

## Performance Considerations

### 3.2 Tuning

RMS performs I/O operations using one of the following I/O unit types:

- Blocks
- Multiblocks
- Buckets

A *block* is the basic unit of disk I/O, and it consists of 512 contiguous bytes. Even if your program requests less than a block of data, RMS automatically transfers an entire block.

The other I/O units—multiblocks and buckets—are made up of block multiples. A *multiblock* is an I/O unit that includes up to 127 blocks but whose use is restricted to sequential files. See Section 3.3.2 for details. A *bucket* is the I/O unit for relative and indexed files and it may include up to 63 blocks. See Section 3.4 and Section 3.5 for details.

#### 3.2.1.6 Multiple Areas for Indexed Files

For indexed files, another design strategy is to separate the file into multiple *areas*. Each area has its own extension size, initial allocation size, contiguity options, and bucket size. You can minimize access times by precisely positioning each area on a specific volume, cylinder, or block.

For instance, you can place the data area on one volume of a volume set and place the indexed area on another volume. If your application is I/O bound, this strategy could increase its throughput. You can also derive data bucket contiguity by allocating extra space for future extensions of the data area.

#### 3.2.1.7 Bucket Fill Factor for Indexed Files

Any attempt to insert a record into a filled bucket results in a **bucket split**. When a bucket split occurs, RMS tries to keep half of the records (including the new record, if applicable) in the original bucket and moves the remaining records to a newly created bucket.

Excessive bucket splitting can degrade system performance through wasted space, excessive processing overhead, and file fragmentation. For example, each record that moves to a new bucket must maintain a forward pointer in the original bucket. The forward pointer indicates the record's new location. At the new bucket, the record must maintain a backward pointer to its original bucket. RMS uses the backward pointer to update the forward pointer in the original bucket if the record later moves to yet another bucket.

When a program attempts to access a record either by alternate key or by RFA, it must first go to the bucket where the record originally resided, read the pointer to the record's current bucket residence, and then access the record.

To avoid bucket splits, you should permit buckets to be only partially filled when records are initially loaded. This provides your application with space to make additional random inserts without overfilling the affected bucket.

Section 3.5.2.2 describes fill factors in more detail.

### 3.2.2 Processing Options

Five processing options can be used to improve I/O operations: two file-processing options and three record-processing options. The file-processing options include the deferred-write option and the global buffer option. The global buffer option may be used with all three file organizations, but the deferred-write option is restricted to use with relative and indexed files.

The record-processing options include the multiple buffer option, the read-ahead option and the write-behind option. The multiple buffer option may be used with all three file organizations, but the read-ahead option and the write-behind option may be used only with sequential files.

This section summarizes the options. Section 3.3 through Section 3.5 describe the options in the context of tuning files. For additional information about buffering, see Chapter 7.

#### 3.2.2.1 Multiple Buffers

When a program accesses a data file, it transfers the file from disk into memory using I/O units of blocks, multiblocks, or buckets. The I/O units are subsequently placed in memory *I/O buffers* sized to be compatible with the I/O units.

If you do not have enough buffers, excessive I/O transfers may degrade the performance of your application. On the other hand, if you have too many buffers, performance may degrade because of an overly large working set. As a rule, however, increasing the size and number of buffers can improve performance if the data read into the buffers will soon be processed and if your working set can efficiently maintain the buffers. In fact, changing the size and number of buffers is the quickest way to improve the performance of your application when you are processing localized data.

The optimum number of buffers depends on the organization and use of your data files. The recommended way to determine the optimum number of buffers for your application is to use the Edit/FDL utility.

The number of I/O buffers is a run-time parameter you set with the FDL editor by adding the CONNECT secondary attribute MULTIBUFFER\_COUNT to the definition file. (See Chapter 9.) With a low-level language, you can set the value directly into the RAB\$B\_MBF field of the record access block, or you can set the count using the XAB\$\_MULTIBUFFER\_COUNT XABITM if you want to specify more than 127 buffers.

Alternatively, the number of buffers may be specified for a process using the DCL command SET RMS\_DEFAULT/BUFFER\_COUNT=*n*, where the variable *n* represents the desired number of buffers. With this command, you may set distinct values for your sequential, relative, and indexed files using the appropriate file organization qualifier. If you omit the file organization qualifier, sequential organization is assumed. To examine the current settings for the process and system default multibuffer count, use the DCL command SHOW RMS\_DEFAULT.

If none of the above methods is used, RMS uses the system-wide default value established by the system manager. If the system-wide default is either omitted or is set to 0, RMS uses a value of 1 for sequential and relative files and a value of 2 for indexed files.

## Performance Considerations

### 3.2 Tuning

For more details about using multiple buffers with sequential files, see Section 3.3.3. For more details about using multiple buffers with relative files, see Section 3.4.2. For more details about using multiple buffers with indexed files, see Section 3.5.2.3.

Chapter 7 describes the use of multiple buffers in the context of shared files.

#### 3.2.2.2 Deferred-Write Processing

One way to improve performance through minimized I/O is to use the deferred-write option to keep data in memory as long as practicable. However, you must determine if this added performance benefit is worth the increased risk of losing data if the system crashes before a buffer is transferred to disk.

With indexed files and relative files, you may use the deferred-write option to defer writing modified buckets to disk until the buffer is needed for another purpose or until the file is closed.

Typically, the largest gains in performance come from using the deferred-write option with sequential access. Retrieving and modifying records one after the other permits you to access all of the records from one bucket while the bucket is in memory.

You may also improve performance by using the deferred-write option to prevent writing a shared sequential file to disk on each modification. However, this increases the risk of losing data if the system crashes before the full buffer is transferred to disk.

Note that nonshared sequential files behave as if the deferred-write option is always specified, because a buffer is only written to disk after it is completely filled.

Deferred-write processing is a default run-time option for some high-level languages and can be specified by using clauses in other languages. You can activate this option through FDL by adding the FILE attribute DEFERRED\_WRITE. From a low-level language, you can activate the deferred-write option by setting the FAB\$V\_DFW bit in FAB\$L\_FOP field.

#### 3.2.2.3 Global Buffers

If several processes are to share a file, you may want to provide the file with **global buffers**—I/O buffers that two or more processes can access. With global buffers, processes may access file information without allocating dedicated buffers. If you do not allocate dedicated buffers, you can conserve buffer space and buffer management overhead. You gain this benefit at the cost of additional system resources, as described in the *OpenVMS Record Management Services Reference Manual*.

When you create a file, you can assign the desired number of global buffers by using the FDL editor to set the value for the FILE secondary attribute GLOBAL\_BUFFER\_COUNT. From a low-level language, you can optionally set the value directly into the FAB\$W\_GBC field. Alternatively, you may use the DCL command SET FILE/GLOBAL\_BUFFERS to set the global buffer count.

Global buffers are not used directly to retain modified information when the deferred-write option is enabled. If a global buffer is modified and the deferred-write option is enabled, the contents of the global buffer are copied to a process local buffer before other processes are allowed to access the global buffer contents. Subsequent use of the modified buffer by the process that deferred the writeback refer to the process local buffer while it remains in the process local cache.

Reference to the global buffer by another process causes the contents of the process local buffer to be written back to disk.

If a global buffer is modified and the deferred-write option is not enabled, then the contents are written out to disk from the global buffer. Therefore, using global buffers along with the deferred-write option may cause a slight increase in processing overhead if in fact no further references to the modified buffer occur before it is flushed from the cache anyway. For that reason, you may want to disable the deferred-write option for processes that do not reaccess buffers after records have been written to them.

Section 3.3, Section 3.4, and Section 3.5 discuss the use of global buffers in tuning the various file types.

#### 3.2.2.4 Read-Ahead and Write-Behind Processing

The operation of sequentially organized files can be improved by implementing read-ahead and write-behind processing. These features improve performance by permitting record processing and I/O operation to occur simultaneously. The read-ahead and write-behind features are default run-time attributes in some languages, but they must be explicitly specified in others.

You implement read-ahead and write-behind processing by using two buffers. The processing program uses one buffer, and the I/O subsystem uses the other. In read-ahead processing, the program reads data from one buffer as the second buffer inputs data from the disk. In write-behind processing, one buffer accepts output data from the program, while the second buffer outputs program data to a disk.

The next section provides additional information about read-ahead and write-behind processing.

### 3.3 Tuning a Sequential File

Sequential files consist of a file header and a series of data records. Records are stored in the order in which they are written to the file.

The following sections provide guidelines for improving the performance of sequential file processing using various tuning options.

#### 3.3.1 Block Span Option

You should always specify that records in a sequential file are permitted to span blocks, that is, to cross block boundaries. In this way, RMS can pack the records efficiently and avoid wasted space at the end of a block. Note that you cannot turn off this option for STREAM formatted files.

By default, the FDL editor activates **block spanning** for files organized *sequentially* by setting the RECORD secondary attribute BLOCK\_SPAN to YES. If you are using a low-level language, you activate the block span option directly in the FAB by resetting the FAB\$V\_BLK bit in the FAB\$L\_RAT field.

#### 3.3.2 Multiblock Size Option

A *multiblock* is an I/O unit that includes up to 127 blocks but can be used only with sequential files. When a program instructs RMS to fetch data within a multiblock, the entire multiblock is copied from disk to memory.

## Performance Considerations

### 3.3 Tuning a Sequential File

You specify the number of blocks in a multiblock using the *multiblock count*, a run-time option. If you are using the FDL editor, specify the multiblock count option using the secondary CONNECT attribute, MULTIBLOCK\_COUNT. From a lower-level language, you may set the value into the RAB\$B\_MBC field, directly. Another alternative is to establish the count using a DCL command of the following form:

```
SET RMS_DEFAULT/BLOCK_COUNT=n
```

The variable *n* represents the specified number of blocks. Here, the specified multiblock count is limited to your process unless you specify the /SYSTEM qualifier.

In most cases, the largest practical multiblock value to specify is the number of blocks in one track of the disk, a number that varies with the various types of disks. (See the *OpenVMS I/O User's Reference Manual* for the supported track sizes). However, the most efficient number of blocks for your application may be more or less than the number of blocks in a track. You should try various sizes of multiblocks until you find the optimum value.

#### 3.3.3 Number of Buffers

For sequential files, you can specify the number of buffers at run time. From FDL, you can set the number of buffers with the secondary CONNECT attribute MULTIBUFFER\_COUNT. From an assembler language, you can set the value directly into the RAB\$B\_MBF field in the RAB, or you can set the count using the XAB\$ MULTIBUFFER\_COUNT XABITM if you want to specify more than 127 buffers. From the DCL interface, you can establish the number of buffers using a DCL command in the following form:

```
SET RMS_DEFAULT/SEQUENTIAL/DISK/BUFFER_COUNT=n
```

The variable *n* represents the number of buffers.

In simple operations with sequential files, one I/O buffer is sufficient. Increasing the number of buffers uses space in the process working set and could degrade performance.

With nonshared sequential files, particularly if you want to perform sequential access, you can use read-ahead and write-behind processing. With this type of processing, a buffer contains the next record to be read or written to the disk while a separate buffer completes the current I/O operation.

The length of the buffers used for sequential files is determined by the specified multiblock count. The optimal number of blocks per buffer depends on the record size for sequential access to a sequential file, but a value such as 16 may be appropriate.

#### 3.3.4 Global Buffer Option

If a file is shareable, you may want to allocate it global buffers. A **global buffer** is an I/O buffer that two or more processes can access. If two or more processes are requesting the same information from a file, I/O can be minimized because the data is already in the global buffer. This is especially true for program sequences in which all of the processes are reading data.

For shared sequential file operations, the first accessor of the file uses the multiblock count to establish the global buffer size for all subsequent accessors.

Note that RMS also provides each process with local I/O buffers to attain efficient buffering capacity.

### 3.3.5 Read-Ahead and Write-Behind Options

Specifying the read-ahead and write-behind options for sequential files can improve performance. The read-ahead and write-behind options require at least two I/O buffers and the *multibuffer* attribute. Note that using more than two I/O buffers usually does not improve performance. (See Section 3.3.3.)

Most languages incorporate the read-ahead and write-behind options by default. With some languages, you must specify the read-ahead and write-behind options explicitly using a clause in the language. If an OpenVMS language does not have a clause for specifying the read-ahead and write-behind options, you must use a VAX MACRO routine to select these options when you open the file.

At the VAX MACRO level, you can select these options by setting the RAB\$V\_RAHAH bit in the RAB\$L\_ROP field for read-ahead processing and the RAB\$V\_WBHBH bit for write-behind processing prior to requesting the Connect service.

You can also use FDL to select these options by using the secondary CONNECT attributes READ\_AHEAD and WRITE\_BEHIND respectively.

As of OpenVMS Alpha Version 7.3-1, a new RMS system feature related to write-behind was implemented:

#### Write-Behind Option as a System Default

A dynamic SYSGEN parameter (RMS\_SEQFILE\_WBHBH) can be used to externally request RMS to implement the write-behind feature as a system default. (See the *OpenVMS System Manager's Manual*.) If this system option is set, RMS implements the existing RMS user write-behind option as a system default (regardless of the RAB\$L\_ROP RAB\$V\_WBHBH setting) whenever write access is requested for an unshared sequential file opened for image I/O.

This feature is a system option. It is not the default for the following reasons:

1. Enabling write-behind involves a change in error reporting that could affect some application (a write error may be reported for a subsequent operation rather than for the write the error occurred on).
2. The allocation of an additional RMS intermediate buffer may result in more page faulting if process working set quotas are insufficient.

## 3.4 Tuning a Relative File

A relative file consists of a file header, file attributes, a prolog, and a series of fixed-length cells. Each cell contains one record that includes a deleted-record byte followed by the data portion of the record, which may or may not be blank.

RMS assigns each cell a sequential number, called the relative record number, that can be used to randomly access the record.

A relative file can contain fixed-length records, variable-length records, or VFC records. Fixed-length records are particularly useful in relative files because of the fixed cell size.

The maximum size for fixed-length records in a relative file is 32,255 bytes. For variable-length records the maximum size is 32,253 bytes. The maximum size for VFC records is 32,253 bytes minus the size of the fixed-length control field, which may be up to 255 bytes long.

## Performance Considerations

### 3.4 Tuning a Relative File

#### 3.4.1 Bucket Size

With relative files, buckets are used as the unit of transfer between the disk and memory. You specify bucket size when you create the file, but you can change the size later by converting the file (see Chapter 10.) Note that the Convert utility processes relative files by sequentially reading records from the input file, then writing them to the output file. As a result, the relative record numbers (RRN) change when the input file contains deleted or unused records.

You can specify the bucket size using the FDL FILE secondary attribute `BUCKET_SIZE` or by inserting the value directly into the RMS control block fields `FAB$B_BKS` and `XAB$B_BKZ`. Although the size can be as large as 63 blocks, a bucket size larger than one disk track usually does not improve performance.

If you choose to select the bucket size, you should also consider how your application accesses the file. For random access, you may want to choose a small bucket size; for sequential access, a large bucket size; and for mixed access, a medium bucket size.

One way to improve performance for a relative file is to align the file on a cylinder boundary and specify the size of one disk track as the bucket size. However, this requires that you can perform an exact alignment on the file.

If you use the FDL editor to establish the bucket size (this is recommended), the editor fixes the size at the optimum value based on your script inputs.

If you intend to access the file randomly, EDIT/FDL sets the bucket size equal to four records because it assumes that four records are a reasonable amount of data for a random access. If you intend to access records sequentially, EDIT/FDL sets the bucket size equal to 16 records because it assumes that 16 records is a reasonable amount of data for one sequential access.

If you find that your application needs more data per access, then use the EDIT/FDL command `MODIFY` to change the assigned values.

#### 3.4.2 Number of Buffers

The multibuffer count is a run-time option that you can set with the DCL command `SET RMS_DEFAULT/RELATIVE/BUFFER_COUNT=n`, the FDL attribute `CONNECT MULTIBUFFER_COUNT`, the RMS control block field `RAB$B_MBF` or the `XAB$_MULTIBUFFER_COUNT` XABITM. The type of record access determines the best use of buffers.

The two extremes of record access are when records are processed either completely randomly or completely sequentially. Also, there are cases in which records are accessed randomly but may be reaccessed (random with temporal locality) and cases where records are accessed randomly but adjacent records are likely to be accessed (random with spatial locality).

In completely sequential processing, the first record may be located randomly and the following records accessed sequentially (records are usually not referenced more than once). For best performance, you should specify one buffer with a large bucket size unless you use the read-ahead option, which requires two buffers.

Large buckets hold more records, so you can access a greater number of records before performing I/O operations. However, a small multibuffer count, such as the default of 1 buffer, is sufficient.

When you want to improve sequential access performance, you may get better results by tuning the bucket size rather than changing the number of buffers.

Completely random processing means that records are not accessed again, and adjacent records are not likely to be accessed. You should use one buffer with a minimal bucket size. You do not need to build a memory cache because the records are likely to be scattered throughout the file. New requests for records most likely result in an I/O operation, and caching extra buckets wastes space in your working set.

In random with temporal locality processing (reaccessed records), records are processed randomly, but the same records may be accessed again. You should use multiple small buffers to cache records that are to be reaccessed. The bucket size can be small for this type of access because the records near the record currently accessed are not likely to be accessed. Caching reaccessed records in large buckets wastes space in memory. Multiple buffers allow the previously accessed records to remain in memory for subsequent access.

In random with spatial locality processing (adjacent records), records are processed randomly, but the next or previous record has a good chance of being accessed. You should use a large buffer and bucket size to improve the probability that the next record to be processed is in the same bucket as the record most recently processed. One or two buffers should be sufficient.

If you process your data file with a combination of these patterns, you should compromise between the processing strategies. An application illustrating both temporal and spatial access uses the first record in the file as a pointer to the last record accessed. The program reads the first record to find the location of the next record to be processed, processes the record, and updates the pointer in the first record. Because the application accesses the first record frequently, the access pattern exhibits temporal locality, but because it adds records sequentially to the end of the file, the access pattern also exhibits spatial locality.

When you add records to a relative file, you might consider choosing the deferred write option (FDL attribute `FILE DEFERRED_WRITE`, `FAB$L_FOP` field `FAB$V_DFW`). With this option, the contents of the write buffer are not transferred from memory to disk until the buffer is needed for another purpose or until the file is closed. Note, however, that the possibility of losing data during a system crash increases when you use the deferred write option.

To see what the current default buffer count is, give the DCL command `SHOW RMS_DEFAULT`. To set the default buffer count, use the DCL command `SET RMS_DEFAULT/RELATIVE/BUFFER_COUNT=n`, where *n* is the number of buffers.

### 3.4.3 Global Buffer Option

If several processes share a relative file, you may want to specify that the file use the global buffer option. A global buffer is an I/O buffer that two or more processes can access. If two or more processes simultaneously request the same information from a file, each process can use the global buffers instead of allocating its own dedicated buffers. Only one copy of the buffers resides at any time in memory, although the buffers are charged against each process's working set size.

Using the global buffer option to form a memory cache may not reduce the number of I/O operations necessary to process the file in all cases. Regardless of how many global buffers you allocate, RMS always allocates one I/O buffer per process, which provides efficient buffering capacity.

## Performance Considerations

### 3.4 Tuning a Relative File

If your application has several processes sharing the file and accessing the same records in a transaction sequence, then you may benefit from allocating enough global buffers to cache these shared records.

#### 3.4.4 Deferred-Write Option

The deferred-write option is a run-time option that can improve performance. It is the default operation for some high-level languages and can be specified by clauses in other high-level languages.

If there is no language support, you can use a VAX MACRO subroutine to set the FAB\$V\_DFW bit in the FAB\$L\_FOP field before opening the file.

When you select the deferred-write option, RMS delays writing a modified bucket to disk until the buffer is needed for another purpose or until another process needs to use the bucket. This delay improves performance because it reduces the number of disk I/O operations. You achieve the largest performance gains using the deferred-write option with sequential access file operations.

For example, in a relative file with 100-byte records and 2-block buckets, 10 records fit in one bucket. Without the deferred-write option, writing records 1 through 10 in order results in eleven I/O operations—one for the initial file access and one for each of the records.

With the deferred-write option, you need only two I/O operations—one for the initial file access and one to write the bucket.

A larger cache might be useful in situations in which the accesses are not strictly sequential but follow some local pattern.

## 3.5 Tuning an Indexed File

This section discusses the structure of indexed files and ways to optimize their performance.

### 3.5.1 File Structure

An indexed file consists of a file header, a prolog, and one or more index structures. The primary index structure contains the data records. If the file has alternate keys, it has an alternate index structure for each alternate key. The alternate index structures contain secondary index data records (SIDRs) that provide pointers to the data records in the primary index structure. The index structures also contain the values of the keys by which RMS accesses the records in the indexed file.

#### 3.5.1.1 Prologs

RMS places information concerning file attributes, key descriptors, and area descriptors in the prolog. You can examine the prolog with the Analyze/RMS\_File utility described in Chapter 10.

There are three types of prologs: Prolog 1, Prolog 2, and Prolog 3.

##### **Prolog 1 and Prolog 2 Files**

Any indexed file created with a version of the operating system lower than Version 3.0 is either a Prolog 1 file or a Prolog 2 file. Prolog 1 files and Prolog 2 files operate identically.

If an indexed file uses only string data-type keys, the file is a Prolog 1 file.

---

**Note**

---

The string data-type keys include STRING, DSTRING, COLLATED, and DCOLLATED keys.

---

If an indexed file uses numeric type keys, it is a Prolog 2 file.

You cannot use the Convert/Reclaim utility on a Prolog 1 file or a Prolog 2 file to reclaim empty buckets. If your file undergoes a large number of deletions (resulting in empty, unusable buckets), you must use the Convert utility (CONVERT) to reorganize the file. (Note that CONVERT establishes new RFAs for the records.)

The compression allowed with Prolog 3 files is not possible with Prolog 1 or Prolog 2 files.

**Prolog 3 Files**

Prolog 3 files can accept multiple (or alternate) keys and all data types (including the nonstring 8-byte BIN8 and INT8 types). They also give you the option of saving space by compressing your data, indexes, and keys.

Key compression compresses the key values in the data buckets. Likewise, index compression compresses the key values in index buckets, and data compression compresses the data portion of the records in the data buckets.

Key or index compression is restricted to the string key data type and the string must be at least 6 bytes in length.

---

**Note**

---

You cannot use key compression or index compression with any numeric or collated key data types.

---

With key or index compression, repeating leading and trailing characters are compressed. With front key compression, any characters that are identical to the characters at the front of the previous key are compressed. For example, the keys JOHN, JOHNS, JOHNSON, and JONES appear as JOHN, S, ON, and NES.

With rear key compression, any repeating characters at the end of the key are compressed to a single character. For instance, the key JOHNSON00000 appears as JOHNSON0.

Enabling index compression results in RMS doing a sequential search in index buckets rather than its default binary search, since each index key value must be expanded until a match is found.

With data compression, RMS can compress sequences of up to 255 repeating characters in the data portion of the user data records. For optimal performance, RMS does not compress sequences having less than five repeating characters.

Compression has a direct effect on CPU time and disk space. Compression increases CPU time, but the keys are smaller, so your application can scan more quickly through the data and index buckets.

## Performance Considerations

### 3.5 Tuning an Indexed File

The disk space saved by using Prolog 3 indexed files can significantly improve performance. With compression, each I/O buffer can hold more information to improve buffer space efficiency. Compression can also decrease the number of index levels, which decreases the number of I/O operations per random access.

Prolog 3 files can have segmented primary keys, but the segments cannot overlap. If you want to use a Prolog 3 file in this case, consider defining the overlapping segmented key as an alternate key and choosing a different key to be the primary key. If you want to use overlapping primary key segments, you must use a Prolog 2 file.

If record deletions result in empty buckets in Prolog 3 files, you can use the Convert/Reclaim utility to make the buckets usable again. Because CONVERT/RECLAIM does not create a new file, RFAs remain the same.

Note that RMS-11 does not support Prolog 3 files. To use a Prolog 3 file with RMS-11 you must first use the Convert utility to transform the file into a Prolog 1 file or into a Prolog 2 file.

#### 3.5.1.2 Primary Index Structure

The primary index structure consists of the file's data records and a key pathway based on the primary key (key 0). The base of a primary index structure is the data records themselves, arranged sequentially according to the primary key value. The data records are called level 0 of the index structure.

The data records are grouped into buckets, which is the I/O unit for indexed files. Because the records are arranged according to their primary key values, no other record in the bucket has a higher key value than the last record in that bucket. This high key value, along with a pointer to the data bucket, is copied to an *index record* on the next level of the index structure, known as level 1.

The index records are also placed in buckets. The last index record in a bucket itself has the high key value for its bucket; this high key value is then copied to an index record on the next higher level. This process continues until all of the index records on a level fit into one bucket. This level is then known as the root level for that index structure.

Figure 3-1 is a diagram of an index structure.

Figure 3-2 illustrates a primary index structure. (For simplicity, the records are assumed to be uncompressed, and the contents of the data records are not shown.) The records are 132 bytes long (including overhead), with a primary key field of 6 bytes. Bucket size is one block, which means that each bucket on Level 0 can contain three records. You calculate the number of records per bucket as shown by the following algorithm:

$$\frac{\text{Block Size} - \text{Bytes of Overhead}}{\text{Record Size (Including Overhead)}} = \text{Records Per Bucket}$$

Substituting the values in this instance:

$$\frac{512 - 15}{132} = 3.77$$

Note that you must round the result down to the next lower integer, in this case, the integer 3.

Figure 3-1 RMS Index Structure

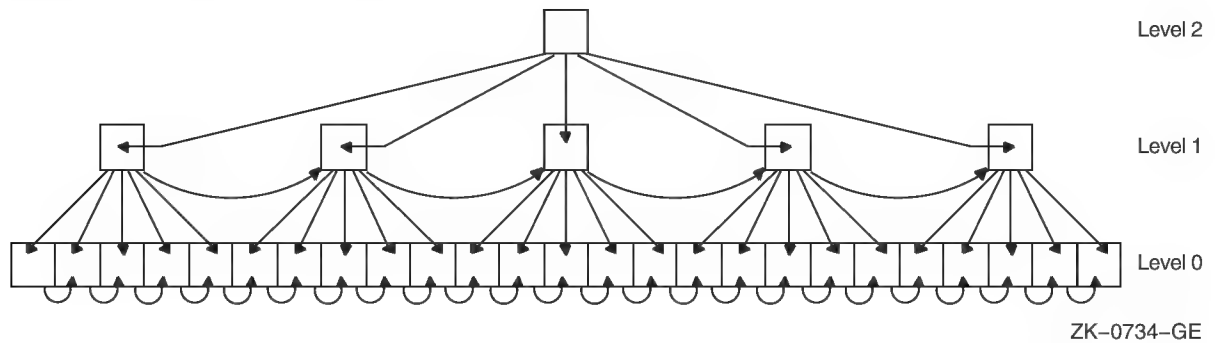

Because the key size is small and the database in this example consists of only 27 records, the index records can all fit in one bucket on level 1. The index records in this example are 6 bytes long. Each index record has one byte of control information. In this example, the size of the pointers is 2 bytes per index record, for a total index record size of 9 bytes. You calculate the number of records per bucket in this case as follows:

$$\frac{512 - 15}{9} = 55.2$$

Again, you must round the remainder down to the next lower integer, 55.

Figure 3-2 Primary Index Structure

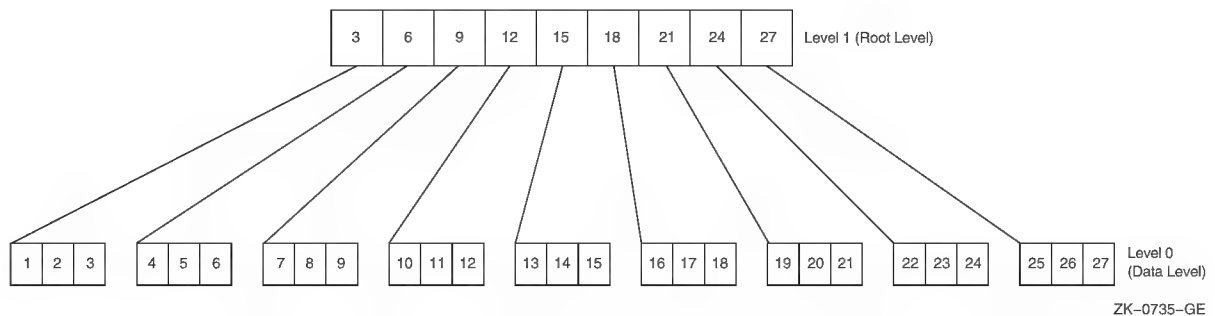

To read the record with the primary key 14, RMS begins by scanning the root level bucket, looking for the first index record with a key value greater than or equal to 14. This record is the index record with key 15. The index record contains a pointer to the level 0 data bucket that contains the records with the keys 13, 14, and 15. Scanning that bucket, RMS finds the record (see Figure 3-3).

## Performance Considerations

### 3.5 Tuning an Indexed File

Figure 3–3 Finding the Record with Key 14

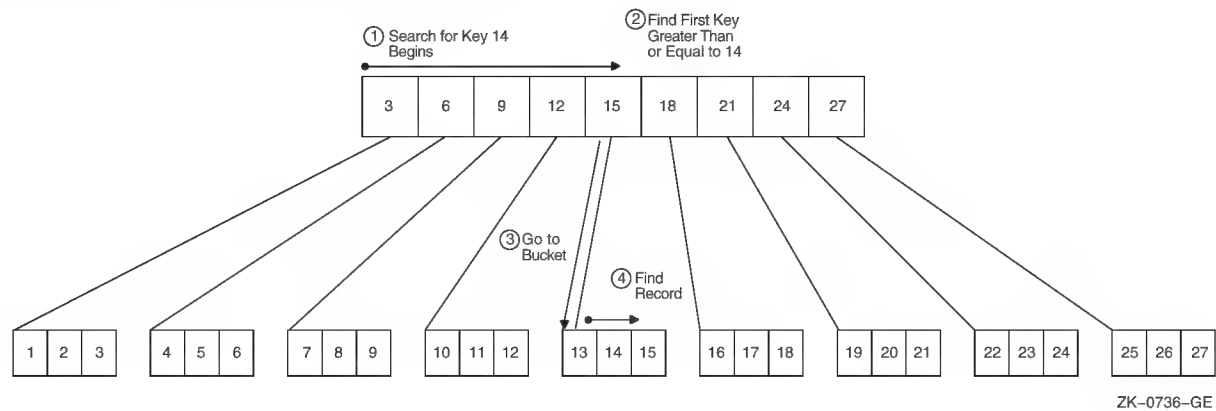

#### 3.5.1.3 Alternate Index Structure

Alternate indexes (also referred to as secondary indexes) provide your program with alternate record processing. If you have one or more alternate indexes, you can process data records using any of the alternate keys in addition to processing data with the primary key. Note that a file with alternate indexes does require additional disk space.

The alternate index structure is similar to the primary index structure except that, instead of containing data records, alternate indexes contain secondary index data records (SIDRs). An SIDR includes an alternate key value from a data record in the primary index and one or more pointers to data records in the primary index. (SIDRs have pointers to more than one record only if you allow duplicate keys and there are duplicate key values in the database.) You do not need an SIDR for every data record in the database. If a variable-length record is not long enough to contain a given alternate key, an SIDR is not created. For example, if you define an alternate key field to be bytes 10 through 20 and you insert a 15-byte record, no SIDR is created in that alternate index structure.

When you create a file, you can use null key values to improve performance for programs that use alternate keys. When a secondary index has relatively few entries, performance may diminish because RMS tries to treat the null entries (typically blank keys) as duplicates. The resultant duplicate-key processing is unnecessary and can be avoided by assigning a null key value for the index. By using a null key value, you minimize the list of duplicates. This can improve performance when you insert records because the null key entries do not get processed as index entries. Note that when you sequentially access records using null key processing, null records are not processed.

If you use the string data type, RMS uses the ASCII null character as the default null key value. However, you can specify any character as the null value. If you use numeric keys, RMS uses zero (0) as the null value.

#### 3.5.1.4 Records

Records in an indexed file can be fixed-length records or variable-length records. Fixed-length records begin with a record header. Variable-length records include a record header followed by a 2-byte count field that contains the number of data bytes in the record. Unlike variable-length records in relative files, each variable-length record in an indexed file requires only enough space for the record. See Table 2–2 for more information on record overhead.

Records cannot span bucket boundaries.

For Prolog 3 files, the maximum record size is 32,224 bytes. For Prolog 1 files and Prolog 2 files, the maximum length for a fixed-length record is 32,234 bytes; the maximum length for a variable-length record is 32,232 bytes. Note that when you specify a record length for a Prolog 3 file that is greater than the maximum record length, RMS automatically converts the file to a Prolog 1 or Prolog 2 file.

Record length should reflect application requirements. There is no advantage to using a record length that is based on the number of bytes in a bucket.

The value of the primary key must be contained within the records. The records can contain either a valid key field value for the alternate keys or, if you specify that null keys are allowed, a field of null characters.

### 3.5.1.5 Keys

A **key** is a record field that identifies the record to help you retrieve the record. There are two types of keys—primary keys and alternate keys. Data records are filed in the order of their primary key. The most time-efficient value for primary keys is a unique value that begins at byte 0 of the record. You can allow duplicate keys in the primary index, but duplicate keys may slow performance.

The primary key and alternate keys can be character strings or numerical values. Key type is specified by the FDL attribute KEY TYPE.

If it is not possible to put the records into the file in order of their primary key, you should specify that the buckets not be filled completely when the file is loaded. If you attempt to write a record to a full bucket, a bucket split occurs. RMS keeps half of the records in the original bucket and moves the other records to the newly created bucket. Each time a record moves to a new bucket, it leaves behind a forwarding pointer called a *record reference vector (RRV)*. You should avoid bucket splits because they use additional disk space and CPU time. An extra I/O operation is required to access a record in a split bucket when the program accesses a record by an alternate key or by RFA.

Alternate keys have a direct impact on I/O operations, CPU time, and disk space. The number of I/O operations and the CPU time required for Put, Update, and Delete operations are directly proportional to the number of keys. For example, inserting a record with a primary key and three alternate keys takes approximately four times longer than inserting a record with only a primary key.

To update the value of an alternate key, you have to traverse the alternate index structure twice, and bucket splits are more likely to occur. Randomly accessing an alternate key generally requires an extra I/O operation over a comparable access by the primary key, and extra disk space is required to store each alternate index structure.

Alternate keys are more likely than primary keys to have duplicate values. For example, the zip code is a common alternate key. However, allowing many duplicate values can have a performance cost. Duplicate values can cause clustered record or pointer insertions in data buckets, long sequential searches, a large number of I/O operations, and loss of physical contiguity due to continuation buckets (especially for the primary key).

Where possible, you should validate record keys before inserting the record, especially when you have primary and alternate keys.

In general, as the number of keys increases, so does the time it takes to add and delete records from your file. If CPU time is a critical resource on your system, you should define as few keys as possible.

## Performance Considerations

### 3.5 Tuning an Indexed File

If you are reading records in your file, the number of keys has relatively little impact on performance.

#### 3.5.1.6 Areas

An **area** is a portion of an indexed file that RMS treats as a separate entity. You can divide an indexed file into separate areas where each area has its own bucket size, initial allocation, extension size, and volume positioning, just as if each area were a separate file.

Using multiple areas has distinct advantages. However, if each area has a different bucket size, all buffers are as large as the largest bucket. If you use multiple areas, the file itself is probably not contiguous; however, you can make each area within the file contiguous by specifying the FDL attribute `AREA CONTIGUOUS`. To ensure that the area is created without error, use the `AREA BEST_TRY_CONTIGUOUS` attribute.

When you separate key and data areas, you tend to keep related buckets close together, thereby decreasing disk seek time. You also minimize the number of disk-head movements for a series of operations. For example, if you have a dedicated multidisk volume set, you could place the data level of a file in an area on one disk and the index levels of the file in an area on a separate disk. Then there is little or no competition for the disk head on the disk that contains the index structures.

One strategy is to allocate a separate area for level 0 of a primary index (the data level). These buckets are the only ones referenced when you access the records sequentially by their primary key, so keeping them in a separate area optimizes that type of operation.

Do not allocate separate areas for level 1 of an index and the other index levels if the index has just one level. In such a case, you force RMS to create an additional level in the index structure.

In most cases, you should allocate at least one area for each alternate index structure. By default, EDIT/FDL creates two areas in an indexed file for each index structure—one for the data level and one for all of the index levels. You can allocate up to 255 areas, so with most applications you can set up enough areas to handle all alternate index structures.

It is possible to set up a separate area for each of the following:

- Primary index level 0 (the data records)
- Primary index level 1 (the lowest index level)
- Primary index levels 2+ (the rest of the index levels)
- Alternate index level 0 (the secondary index data records)
- Alternate index level 1 (the lowest index level)
- Alternate index levels 2+ (the rest of the index levels)

Be sure to allocate sufficient space for each area and to specify area contiguity, because extending an area generally creates a noncontiguous area extent. The resulting noncontiguous extent may be anywhere on the disk, and you may lose the benefits of multiple areas.

## Performance Considerations

### 3.5 Tuning an Indexed File

If you are using a single area for the file, you should allocate enough contiguous space at creation time for the entire file. If you plan to add data to the file later, you should allocate extra space using the FDL attribute `FILE ALLOCATION`. To ensure contiguous allocation, set the FDL attribute `FILE CONTIGUOUS` to `YES`.

If you are using multiple areas, you should allocate each one by specifying a value for the FDL attribute `AREA ALLOCATION`.

If the file is relatively small, or if you know that it needs to be extended, you do not have to use multiple areas. In such cases, it is more important to calculate the proper extension size.

To specify multiple areas using an FDL file, you assign each area its own `AREA` primary attribute. The `AREA` primary attribute takes as an argument a number whose value identifies the area.

Use the `KEY` attributes `DATA_AREA`, `LEVEL1_INDEX_AREA`, and `INDEX_AREA` to match each area specified with its index level. In the primary index structure, the primary attribute `KEY` must take the value 0. Within the `KEY` 0 section, you assign the `DATA_AREA` attribute the number which identifies the data record area.

Then you associate the `KEY LEVEL1_INDEX_AREA` attribute with an `AREA` by assigning the appropriate area number to the `LEVEL1_INDEX_AREA` attribute. You also assign the appropriate area number to the `INDEX_AREA` attribute for the other index levels in the primary index structure. For each alternate index structure, you use the same attributes (`DATA_AREA`, `LEVEL1_INDEX_AREA`, `INDEX_AREA`) in another `KEY` primary attribute. In `KEY` sections that define alternate keys, the `DATA_AREA` is where RMS puts the `SIDRs`.

#### 3.5.2 Optimizing File Performance

This section discusses adjustments in file design that can improve a file's performance.

##### 3.5.2.1 Bucket Size

For indexed files, the bucket size controls the number of levels in the index structure, which has the greatest impact on performance for most applications. You can specify the bucket size with the FDL attribute `FILE BUCKET_SIZE` or the control block fields `FAB$B_BKS` and `XAB$B_BKZ`. When you sequentially access files, large buckets are generally beneficial.

For keyed access to index files, set the bucket size so that the number of index levels does not exceed four. In general, the smaller the bucket size, the deeper the tree structure. If you find that a small increase in bucket size eliminates one level, use a larger bucket size. At some point, however, the benefit of having fewer levels is offset by the cost of scanning through the larger buckets.

As a rule, you should never increase bucket size unless the increase reduces the number of levels. For example, you may find that a bucket size of 4 or more yields an index with four levels, and a bucket size of 10 or more yields an index with three levels. In this case, you never want to specify a bucket size of 9 because that does not reduce the number of levels, and performance does not improve. In fact, such a specification could hurt performance because each I/O operation takes longer, yet the number of accesses remains the same. However, larger bucket sizes always improve performance if you are accessing the records sequentially by primary key because more records fit in a bucket.

## Performance Considerations

### 3.5 Tuning an Indexed File

Conversely, with smaller buckets you have to search fewer keys. So if you can cache your whole structure (except for level 0), you can save a lot of time. Also, performance in this case is comparable to flat file design although add operations may take a little longer.

You can decrease the depth of your index structure in two ways. First, you can increase the number of records per bucket by increasing the bucket size, increasing the fill factor, using compression, or decreasing the size of keys and records.

---

#### Note

---

You cannot use key compression or index compression with the collated key data type.

---

However, changing the bucket size also has disadvantages. Larger buckets use more buffer space in memory. And the number of records per bucket determines bucket search time, which directly affects CPU time. A larger fill factor decreases the room for growth in the file, so bucket splits may occur. Compression increases the record search time.

Alternatively, you can reduce the index depth by decreasing the number of records in the file.

If you are using multiple areas, you can set a different bucket size for each area. You should use different bucket sizes if you are performing random accesses of records in no predictable pattern and if the data records are large. Using different bucket sizes allows you to specify a smaller size for the index structures and SIDRs than for the primary data level.

You can use the Edit/FDL utility to determine the optimum bucket size.

Use the same bucket size for all areas if the data records are small or if the record accesses follow a clustered pattern, that is, if the records that you access have keys that are close in value.

In general, increasing the bucket size increases other resources:

- Levels in the tree structure
- Buckets needed to maintain the tree structure
- Buffers needed for cache

Conversely, decreasing the bucket size *decreases* the pages per bucket and the average number of keys searched while traversing the tree.

#### 3.5.2.2 Fill Factor

If you know that the application makes random insertions into the database, you should reserve some space in the buckets when records are first loaded into the file. You can specify a fill factor from 50% to 100%. For example, a fill factor of 50% means that RMS writes records in only half of each bucket when the records are first loaded, leaving the remainder of the bucket empty for future write operations. This fill factor minimizes the number of bucket splits.

The fill factor is set with the FDL attributes `KEY DATA_FILL` and `KEY INDEX_FILL`. The value assigned to both attributes should be the same.

When you specify a fill factor, consider the following:

- If the inserted records are distributed unevenly (highly skewed) by their primary key value, then specifying a fill factor of less than 100% does not reduce the number of bucket splits.
- If the records have key values that are close or if they are added at one end of the file, many bucket splits occur anyway, and the partially filled buckets in the database just waste space. If this is the case, you should either specify a fill factor of 100% and use the Convert utility to reorganize the file after the insertions are made, or you should choose a different primary key.
- If the inserted records are distributed fairly evenly or by their primary key, then specifying a fill factor of less than 100% could significantly reduce bucket splits. However, the trade-off is initially wasted disk space.

### 3.5.2.3 Number of Buffers

At run time, you can specify the number of buffers with the FDL attribute `CONNECT MULTIBUFFER_COUNT`, the control block field `RAB$B_MBF`, or the `XAB$_MULTIBUFFER_COUNT` XABITM. The number of buffers each application needs depends on the type of record access your application performs.

The minimum number of buffers for indexed files is two. If the application performs sequential access on your database, two buffers are sufficient. More than two buffers for sequential access could actually degrade performance. During a sequential access, a given bucket is accessed as many times in a row as there are records in the bucket. After RMS has read the records in that bucket, the bucket is not referenced again. Therefore, it is unnecessary to cache extra buckets when accessing records sequentially.

When you access indexed files randomly, RMS reads the index portion of the file to locate the record you want to process. RMS tries to keep the higher-level buckets of the index in memory; the buffers for the actual data buckets and the lower level index buckets tend to be reused first when other buckets need to be cached. Therefore, you should use as many buffers as your process working set can support so you can cache as many buckets as possible.

When you access records sequentially, even after you have located the first record randomly, you should use a large bucket size. A small multibuffer count, such as the default of two buffers, is sufficient.

If you process your data file with a combination of the above access modes, you should compromise on the recommended bucket sizes and number of buffers.

When you add records to an indexed file, consider choosing the deferred-write option (FDL attribute `FILE DEFERRED_WRITE`; `FAB$L_FOP` field `FAB$V_DFW`). With this option, the buffer into which the records have been moved is not written to disk until the buffer is needed for other purposes, the Flush service is used, or until the file is closed. The deferred-write option, however, may cause records to be lost if a system crashes before RMS transfers the records to the disk.

In general, you must consider several trade-offs when you set the number of buffers your application needs:

- CPU time
- Availability of memory and number of page faults
- I/O operations

## Performance Considerations

### 3.5 Tuning an Indexed File

With indexed files, buckets (not blocks) are the units of transfer between the disk and memory. You specify the bucket size when you create the file, although you can change the bucket size of an existing file with the Convert utility (see Chapter 10).

#### 3.5.2.4 Global Buffers

If several processes share the indexed file concurrently, you may want to specify that the file use global buffers. A global buffer is an I/O buffer that two or more processes can access. If two or more processes request the same information from a file, each process can use the global buffers instead of allocating its own.

Only one copy of the buffers resides at any one time in memory although the buffers are charged against each process's working set size.

The guideline for using global buffers is the same as the guideline for using local process I/O buffers. Global buffers only provide significant benefits if more than one process refers to the same bucket in the global cache. If bucket contention is high, I/O transfers can be minimized and performance improved. However, global buffers do not always improve performance. For example, multiple processes independently reading records and using sequential access are most apt to refer to separate buckets. In that case, bucket contention is low and the number of I/O transfers is not reduced, so global buffers do not improve performance.

#### 3.5.2.5 Using the Deferred-Write Option

The deferred-write option is a run-time option that can improve performance. It is the default operation for some high-level languages and can be specified by clauses in other high-level languages.

If there is no language support, you can call a VAX MACRO subroutine that sets the FAB\$L\_FOP field, the FAB\$V\_DFW option.

When you select the deferred-write option, RMS delays writing a modified bucket to the disk until the buffer is needed to read another bucket into the cache or until another process needs to reference the modified bucket. If a subsequent operation references the bucket before it is flushed out to disk, then one I/O operation has been eliminated. Typically, the largest performance gains come from using the deferred-write option with sequential access because random accesses of the file usually result in several I/O operations to bring in the single records.

Not all operations on indexed files can be deferred. Any operation that causes a bucket split forces the writeback of the modified buckets to disk. (This forced writeback decreases the chances of lost information should a system failure occur.)

Using the deferred-write option improves performance if you are performing multiple I/O operations on a bucket. Consider the following example. The indexed file has a single key and its records are 100 bytes long. The bucket size is 3 blocks with a fill factor of 67%. Thus, there is an average of 10 records in each bucket. A batch program reads each record and updates part of it, beginning at the first record in the file and moving through the records sequentially. Without the deferred-write option, 11 disk I/O operations occur for every 10 records—one to read the bucket and one to write the bucket for each record. With the deferred-write option, only two disk I/O operations occur for every 10 records—one to read the bucket and one to write the bucket after the record operations are completed.

## 3.6 Monitoring RMS Performance

You can improve file performance by gathering statistics on RMS activity. Then, you can use these statistics to fine-tune the file. When you have enabled the gathering of statistics, you can selectively use the Monitor utility to view them.

You normally enable statistics gathering prior to opening a file and then turn on the Monitor utility periodically to measure file performance as desired. However, the Monitor utility can begin monitoring a file even before an application opens the file.

In all cases, the following restrictions apply to statistics gathering:

- All other processes accessing the file must close the file before you can enable statistics gathering.
- Statistics gathering is not supported for ODS-1 disks.
- You cannot collect statistics for process-permanent files. If a file is opened for both process-permanent activity and as a standard file, the process-permanent activity is not included in the statistics.
- Non-RMS file activity is not included in RMS statistics.

### 3.6.1 Enabling RMS Statistics

You can enable statistics gathering in one of three ways:

- Through the DCL interface using the SET FILE/STATISTICS command
- From a program through the Create service using a \$XABITM macro
- Through the FDL interface by assigning the FILE secondary attribute FILE\_MONITORING when creating the file

The Monitor utility begins monitoring RMS statistics for a file even if RMS statistics are not enabled. When the Monitor utility's display indicates a 0 in the Active Streams field for a file (see the sample display in Section 3.6.2), one of the following conditions is true:

- OpenVMS RMS statistics have not been enabled.
- The file has not been opened or connected.
- A restriction listed previously in Section 3.6 has been ignored.

From the programming interface, you can determine whether RMS statistics are enabled by using an appropriately configured XABITM. You can interactively determine whether RMS statistics are enabled by using the DCL DIRECTORY/FULL command. If RMS statistics are enabled, the DIRECTORY/FULL display includes the following line:

```
RMS attributes:      File statistics enabled
```

Note that RMS creates a global page-file section when you initially open a file marked for statistics gathering. Excessive use of statistics gathering might exhaust resources associated with global sections, and if RMS cannot create the global page-file section, the \$OPEN service returns an error. See the *OpenVMS System Services Reference Manual: A-GETUAI* for information about system parameters associated with global sections.

## Performance Considerations

### 3.6 Monitoring RMS Performance

See the *OpenVMS DCL Dictionary* for details about using the DCL interface to enable statistics gathering for a file. The *OpenVMS Record Management Utilities Reference Manual* provides details about enabling RMS statistics for a file through the FDL interface. Instructions for gathering RMS statistics through the program interface are provided in the *OpenVMS Record Management Services Reference Manual*.

#### 3.6.2 Using RMS Statistics

This section provides an example of how you can use RMS statistics to improve file-processing performance. In this example, the system manager suspects that an I/O bottleneck involving the file DATABASE.DAT is causing a system performance problem. To confirm the suspicion, the system manager enables statistics monitoring on the file. Note that, if the system manager does not have sole access to the file, the SET FILE command returns a *file access conflict* error message. You can use the /SHARE qualifier in conjunction with the /STATISTICS qualifier to enable or disable statistics on a file that is currently being accessed. However, only statistics of new accessors of the file will be measured.

The system manager invokes the Monitor utility to obtain a periodic sampling of RMS statistics that describe the processing activity related to DATABASE.DAT. The statistics relating to the operations rate, the buffer caching rate, the data rate, and the locking rate displayed on the Monitor screens provide the system manager with information for making decisions about where to place the file on disk and how to select optimal tuning parameters for the file.

Using the DCL interface, the system manager enables statistics gathering with the following command:

```
$ SET FILE/STATISTICS DATABASE.DAT
```

The SET/FILE STATISTICS command applies an application access control entry (ACE) to the specified file. The ACE does not affect access control and is only meaningful to the application assigning it.

Having enabled RMS statistics, the system manager runs the application and then uses the DCL interface to periodically display the statistics using the following command:

```
$ MONITOR RMS/FILE=DATABASE.DAT/ITEM=CACHING
```

## Performance Considerations

### 3.6 Monitoring RMS Performance

The Monitor utility responds with information displays similar to the following:

```
VAX/VMS Monitor Utility
RMS CACHE STATISTICS
  on node MENASH
  28-FEB-1994

16:03:59
(Index) MENASH$DUA0:[TOREP]DATABASE.DAT;1
Active Streams: 60          CUR          AVE          MIN          MAX
Local Cache Hit Percent    40.00    59.86    38.00    80.00
Local Cache Attempt Rate   59.81    59.26    56.07    60.55
Global Cache Hit Percent   87.54    81.38    57.43   100.00
Global Cache Attempt Rate  23.36    14.88     7.47    23.85
Global Buf Read I/O Rate   0.00     1.21     0.00     2.91
Global Buf Write I/O Rate  0.00     0.00     0.00     0.00
Local Buf Read I/O Rate    12.14     8.84     4.67    13.08
Local Buf Write I/O Rate   29.90    29.63    28.97    29.90
```

Interpretation of RMS cache statistics depends in great part on the application and file organization. The file type (Index) is noted on the display immediately preceding the file specification. The MONITOR display illustrated here is limited to the activity on a single node, MENASH. To obtain a clusterwide view of RMS activity, you must run the Monitor utility using the /RECORD qualifier on all cluster nodes that access the file. You can then analyze the resultant MONITOR recording files to obtain a complete record of RMS activity.

If this display represents a period of activity that the system manager or application developer wants to optimize, then the following observations can be derived:

- The number of *Active Streams* connected to this file and the cache attempt rates verify that this is a very active file that could benefit from performance analysis.
- Global buffer utilization is very good as indicated by *Global Cache Hit Percent*. The relatively few global buffer read I/Os and complete absence of global buffer write I/Os might be due to the fact that index buckets tend to be placed in global buffers. Index buckets are often read but seldom written. Generally, global buffer I/O activity can be reduced by adding global buffers. However, excessive use of global buffers can increase the elapsed time for RMS operations as measured in the application. The Run-Time Library timer routines can be used to measure elapsed time for RMS operations. You can derive an optimal number of global buffers by varying the number and then evaluating the global buffer I/O rates against elapsed time per operation.
- Local buffer read and write I/O rates indicate that the application might be saturating the capacity of the disk (RA81). You can verify this by running the MONITOR DISK option clusterwide and examining the queue length for the disk involved. It might help to spread the file over more than one disk.

There is a tendency for index file data buckets to be placed into local buffers even when a large global buffer cache is present. By varying the number of local buffers and re-examining these statistics, you can pick an optimal number of local buffers. As always, you should check that any buffering changes do not result in additional paging I/Os.

## Performance Considerations

### 3.6 Monitoring RMS Performance

There are other MONITOR utility screens that display information on the rate of various RMS operations being done by the application, the data transfer size per operation, and the locking rates associated with RMS operations. The locking rate screen also displays the number of bucket splits occurring for an indexed file. To display all monitor RMS statistics screens, use the following command:

```
$ MONITOR MONITOR RMS/FILE=DATABASE.DAT/ITEM=ALL
```

For more information about using the SET FILE/STATISTICS command, see the *OpenVMS DCL Dictionary*. The *OpenVMS System Manager's Manual* provides detailed information about using the Monitor utility. For more information on performance management, see *Guide to OpenVMS Performance Management* and *A Comparison of System Management on OpenVMS AXP and OpenVMS VAX*.

### 3.7 Processing in an OpenVMS Cluster Environment

This section discusses designing file applications for an OpenVMS Cluster and the performance you can reasonably expect from the OpenVMS Cluster environment.

---

#### Note

---

In this document, discussions that refer to OpenVMS Cluster environments apply to systems that include only VAX nodes and OpenVMS Cluster systems that include at least one Alpha node unless indicated otherwise.

---

Processing in an OpenVMS Cluster environment offers many advantages:

- **Performance**—In general, the performance of each node in an OpenVMS Cluster is similar to that of a single-node system that has the same processing load, assuming the aggregate I/O per disk drive is reasonable.
- **Availability**—With the appropriate configuration, a node that leaves the OpenVMS Cluster does not stop the OpenVMS Cluster.
- **Flexibility**—You can process shared applications on more than one node.
- **Accessibility**—Shared resources are very easy to use in an OpenVMS Cluster. The synchronized access to the data provides data integrity with no redundancy.

For more information about OpenVMS Clusters, see *OpenVMS Cluster Systems*.

#### 3.7.1 OpenVMS Cluster Shared Access

Shared access is one of the chief advantages of processing in an OpenVMS Cluster environment. Many applications that run on a single-node system can run on an OpenVMS Cluster with no changes.

However, applications that access shared files in an OpenVMS Cluster incur some additional overhead for the OpenVMS Cluster synchronization; the amount of additional overhead depends on the locking requirements of your application.

## Performance Considerations

### 3.7 Processing in an OpenVMS Cluster Environment

#### 3.7.1.1 Locking Considerations

The distributed lock manager allows several users to share files concurrently in an organized manner. RMS uses the lock manager to control file access.

The **lock-mastering node** controls the record and bucket locking for a given file for users on every node of the OpenVMS Cluster. Initially, it is the first node from which the file is opened. However, another node may become the lock-mastering node when a node either joins or leaves the OpenVMS Cluster.

The lock-mastering node may also change every time the file is opened. When another process opens the file (provided that the file was closed), the node on which that process resides becomes the new lock-mastering node for that file.

Lock requests issued by processes on the lock-mastering node incur less cost than lock requests issued from other nodes. Conversely, the lock-mastering node has the additional work of processing lock requests for that file for all other nodes.

The **lock-requesting node** is any node in the OpenVMS Cluster *other* than the lock-mastering node for a given file.

RMS locks buckets and records during record operations only if the file is open for shared writing. Conversely, RMS does no locking during record operations if the file is open for shared read-only access or for exclusive access.

Lock requests for **root locks** (top-level or parent locks) in an OpenVMS Cluster may be slightly slower than on a single-node system. However, these locks are used when you open and close files, so the time for lock operations is only a fraction of the total time needed to open and close files.

There is no performance difference between a single-node system and an OpenVMS Cluster if the file sharing takes place on a single node of the OpenVMS Cluster. Only when sharing spans across the OpenVMS Cluster nodes does distributed locking occur.

As a result, the record locking itself may take a little longer, but because you have multiple CPUs in the OpenVMS Cluster, your application benefits from the added processing power.

Sharing files in an OpenVMS Cluster also requires enough memory for nonpaged pool to store additional lock data structures. This requirement, however, is dependent upon your processing load.

#### 3.7.1.2 I/O Considerations

Sharing files in an OpenVMS Cluster environment also means sharing resources, such as disks and other pieces of I/O hardware. When applications on many nodes share data on one disk, OpenVMS Cluster performance may degrade due to excessive I/O operations.

#### 3.7.2 Performance Recommendations

Four general recommendations about performance in an OpenVMS Cluster environment are described in the following list:

- Estimate the I/O needs of your application. In an OpenVMS Cluster, and particularly with a shared file, multiple nodes can generate many I/O requests to a single disk. The capacity of the disk to handle I/O traffic can affect OpenVMS Cluster performance if you allow your applications to become I/O bound. The Monitor utility is a good tool for estimating how many I/O requests your application generates. For more information about the Monitor utility, see the *OpenVMS System Manager's Manual*.

## Performance Considerations

### 3.7 Processing in an OpenVMS Cluster Environment

- Process files with exclusive access to obtain better performance than processing files with shared-write access. Opening files for unnecessary shared-write access incurs needless locking cost (even on a single node system).
- If possible, confine your application to a single CPU. If sufficient CPU resources and I/O capacity are available, your application performs faster than if it was spread over many nodes.
- Provide for sufficient memory because the space overhead for the lock database and other system software can be significant.

---

## Creating and Populating Files

After you have designed your file, you need to create it. First you must specify the file characteristics you selected during the design phase. Then you need to create the actual file with those characteristics and to protect it (decide who has access to the file). Lastly, you need to put records in the file, or “populate” it.

This chapter describes the process of creating and populating files.

- Section 4.1 tells how to select and specify file-creation characteristics.
- Section 4.2 describes how to create a file.
- Section 4.3 describes how to create and access tagged files.
- Section 4.4 explains how to define file protection.
- Section 4.5 describes how to populate the file.
- Section 4.6 provides a summary of the options related to file creation.

### 4.1 File Creation Characteristics

You can specify the characteristics you need to create a file in two ways.

If you use VAX MACRO or BLISS-32, you can specify file characteristics by including OpenVMS RMS (hereafter referred to as RMS) control blocks in your application program.

If you use a high-level language, you can use the File Definition Language (FDL), a special-purpose language that is used to write specifications for data files. Of course, you also have the option of using FDL with VAX MACRO or BLISS-32.

The following sections describe how you can specify file-creation characteristics by using RMS control blocks or by creating FDL files.

#### 4.1.1 Using RMS Control Blocks

You can establish characteristics for the file you create by using an RMS file access block (FAB) and extended attribute blocks (XABs). These control blocks allow you to take the defaults that RMS provides or to override the defaults and define the characteristics that suit your particular application.

##### 4.1.1.1 File Access Block

The FAB is made up of fields that describe various file characteristics and contain the following file-related information:

- The addresses of the file name string and the default name string
- The file organization
- The record format
- Information about disk storage space

## Creating and Populating Files

### 4.1 File Creation Characteristics

The FAB lets you use both the creation-time characteristics and the run-time characteristics of RMS. You must define one FAB for each file your program opens or creates.

For more information about the FAB, see the *OpenVMS Record Management Services Reference Manual*.

#### 4.1.1.2 Extended Attribute Blocks

Extended attribute blocks (XABs) are optional control blocks that contain supplementary file-attribute information. The following is a partial list of XABs that can be used to provide supporting file information:

- Initial size and extent information (XABALL)
- File protection (XABPRO)
- Key definition (XABKEY)
- Date and time information (XABDAT)

Like FABs, XABs allow you to use both the creation-time characteristics and the run-time characteristics of RMS.

With XABs, you can define various file attributes beyond those specified in the associated FABs.

For more information about the extended attribute blocks, see the *OpenVMS Record Management Services Reference Manual*.

#### 4.1.2 Using File Definition Language

FDL provides a way to create data files using special text files called FDL files. FDL files are written in a file definition language, which permits you to specify appropriate attributes and values for the file.

You create and modify FDL files using the Edit/FDL utility (EDIT/FDL). The Edit/FDL utility contains built-in design algorithms to help you optimize data file design. The Edit/FDL utility recognizes correct FDL syntax and informs you immediately of syntax errors. (You can use a text editor or the DCL command CREATE to create an FDL file, but you must then follow the validity rules listed in the *OpenVMS Record Management Utilities Reference Manual*.)

You can also use the Analyze/RMS\_File utility to create FDL files from existing data files. FDL files created in this manner contain special analysis sections that you can use with the Edit/FDL utility to tune your data files.

You can use the Create/FDL utility and the Convert utility to create data files from the specifications in the FDL files. Note that the Convert utility processes relative files by sequentially reading records from the input file, then writing them to the output file. As a result, the relative record numbers (RRN) change when the input file contains deleted or unused records.

By using an FDL file to create a data file from a high-level language, you can specify most of the creation-time characteristics that are available with RMS control blocks (FABs and XABs). However, to use all of the connect-time features, including wildcard characters, you must use the RMS control blocks.

4.1.2.1 Using the Edit/FDL Utility

You can use the Edit/FDL utility in two ways: with a terminal dialog (interactively) or without one (noninteractively).

If you use the Edit/FDL utility noninteractively, you can execute only the OPTIMIZE script. The OPTIMIZE script lets you optimize an existing FDL file without an interactive session. For more information, see Section 10.3.

Alternatively, if you use the Edit/FDL utility interactively, you can use all the scripts, each of which has a series of menus. When you invoke the Edit/FDL utility, it displays a main menu. To select a menu item, you only need to enter the first letter of the item because each selection has a unique first letter.

Table 4–1 summarizes the Edit/FDL utility commands.

**Table 4–1 Summary of the Edit/FDL Utility Commands**

| Command | Function   |
|---------|--|
| ADD     | Inserts one or more lines into the FDL definition. If the line already exists, you can replace it with your new line. Once you have inserted a line, you can continue to add lines until you are satisfied with that particular primary section. If no primary section exists to hold the secondary attribute being added, the Edit/FDL utility creates one.                                 |
| DELETE  | Removes one or more lines from the FDL definition. If you delete all of the secondary attributes in a primary section, you effectively remove the primary attribute. Once you have removed a line, you can continue to delete lines under that particular primary section.   |
| EXIT    | Creates the output FDL file, stores the current FDL definition in it, and terminates the Edit/FDL utility session. The Edit/FDL utility leaves unchanged any FDL file that it used as input. The FDL file that is created is, by default, a sequential file with variable-length records and carriage-return record attributes, and has your process's default RMS protection and ownership. |
| HELP    | Displays the top level help text for the Edit/FDL utility and then continues to prompt for more keywords. Pressing the Return key in response to the "Topic?" prompt or pressing Ctrl/Z will return you to the main function prompt.   |
| INVOKE  | Prompts you for your choice of scripts and starts a series of logically ordered questions that help you create new FDL files or modify existing ones.  |
| MODIFY  | Allows you to change the value of one or more lines in the FDL definition. Once you have changed a line, you can continue to modify lines under that particular primary section.   |
| QUIT    | Aborts the session without creating an output FDL file. You can also press Ctrl/C or Ctrl/Y to abort the session.  |
| SET     | Allows you to establish defaults or to select any of the Edit/FDL utility characteristics you forgot to specify on the command line.   |
| VIEW    | Displays the current FDL definition.   |
| ?       | Causes the utility to display more information. You can enter the question mark character in response to any question asked by the Edit/FDL utility. In all cases, it will result in repetition of the question. Note too, that the utility responds to an invalid response in the same manner that it responds to a question mark.  |

Ctrl/Z is equivalent to the EXIT command if you use it at the main menu level. If you use it from any other level, Ctrl/Z returns you to the main menu level.

## Creating and Populating Files

### 4.1 File Creation Characteristics

In most cases, a command from the main menu brings up a second level menu. For instance, typing the ADD command displays the following menu:

```
Legal Primary Attributes

ACCESS  attributes set the run-time access mode of the file
AREA x  attributes define the characteristics of file area x
CONNECT attributes set various RMS run-time options
DATE    attributes set the date parameters of the file
FILE    attributes affect the entire RMS data file
KEY y   attributes define the characteristics of key y
NETWORK attributes set run-time network access parameters
RECORD  attributes set the non-key aspects of each record
SHARING attributes set the run-time sharing mode of the file
SYSTEM  attributes document operating system-specific items
TITLE   is the header line for the FDL file

Enter desired primary      (Keyword)[FILE] :
```

One of the most important features of the Edit/FDL utility is that it helps you create FDL files that define indexed, relative, and sequential data files. To do this, the Edit/FDL utility provides seven scripts that guide you through an interactive session. You can choose one of these scripts at the start of a session, or you can instruct the Edit/FDL utility to automatically invoke a particular script each time that you enter the EDIT/FDL command.

Table 4-2 lists the seven scripts.

**Table 4-2 Edit/FDL Utility Scripts**

| Script     | Function  |
|------------|---|
| ADD_KEY    | Allows you to model or add to the attributes of a new index.  |
| DELETE_KEY | Allows you to remove attributes from the highest-level index of your file.  |
| INDEXED    | Begins a dialog in which you are prompted for information about the indexed data file you want to create from the FDL file. The Edit/FDL utility supplies values for certain attributes.  |
| OPTIMIZE   | Helps you redesign an FDL file using an analysis file from the Analyze/RMS_File utility (ANALYZE/RMS_FILE/FDL). The FDL file itself is one of the inputs to the Edit/FDL utility. In effect, this script allows you to tune the parameters of your indexes using the file statistics from the FDL ANALYSIS sections produced by ANALYZE/RMS_FILE. |
| RELATIVE   | Begins a dialog in which you are prompted for information about the relative data file to be created from the FDL file. The Edit/FDL utility supplies values for certain attributes.  |
| SEQUENTIAL | Begins a dialog in which you are prompted for information about the sequential data file to be created from the FDL file. The Edit/FDL utility supplies values for certain attributes.  |
| TOUCHUP    | Begins a dialog in which you are prompted for information about how you want to change an existing index.   |

An interactive session is controlled by these Edit/FDL utility scripts. You can invoke a script in two ways:

- You can select the INVOKE command from the main menu and then choose your script. When you answer the script questions, the Edit/FDL utility displays a list of FDL attributes and their assigned values. At this point, you

## Creating and Populating Files

### 4.1 File Creation Characteristics

can use the Edit/FDL utility commands to further modify the attribute values or to end the editing session.

- You can begin a script by entering a DCL command in the following form:

```
EDIT/FDL/SCRIPT=script-name
```

This command bypasses the main menu to directly display the menu for the selected script.

Example 4–1 shows a sample session with the Edit/FDL utility.

#### Example 4–1 Sample Edit/FDL Utility Session

```
OpenVMS FDL Editor

Add      to insert one or more lines into the FDL definition
Delete   to delete one or more lines from the FDL definition
Exit     to leave the FDL Editor after creating the FDL file
Help     to obtain information about the FDL Editor
❶ Invoke to initiate a script of related questions
Modify   to change existing line(s) in the FDL definition
Quit     to abort the FDL Editor with no FDL file creation
Set      to specify FDL Editor characteristics
View     to display the current FDL Definition
❷ Main Editor Function          (Keyword)[Help] : INVOKE

Script Title Selection

Add Key      modeling and addition of a new index's parameters
Delete Key   removal of the highest index's parameters
Indexed     modeling of parameters for an entire Indexed file
❸ Optimize   tuning of all indexes' parameters using file statistics
Relative     selection of parameters for a Relative file
Sequential   selection of parameters for a Sequential file
Touchup     remodeling of parameters for a particular index
❹ Editing Script Title          (Keyword)[-] : INDEXED
❺ Target disk volume Cluster Size (1-1Giga)[3] : 3
❻ Number of Keys to Define      (1-255)[1] : 1

Line  Bucket Size vs Index Depth      as a 2 dimensional plot
Fill  Bucket Size vs   Load Fill Percent vs Index Depth
❷ Key  Bucket Size vs      Key Length vs Index Depth
Record Bucket Size vs      Record Size vs Index Depth
Init  Bucket Size vs Initial Load Record Count vs Index Depth
Add   Bucket Size vs Additional Record Count vs Index Depth
❸ Graph type to display          (Keyword)[Line] : LINE
❹ Number of Records that will be Initially Loaded
into the File                    (0-1Giga)[-] : 100000
❺ (Fast_Convert NoFast_Convert RMS_Puts)
Initial_File Load Method          (Keyword)[Fast] : FAST
❻ Number of Additional Records to be Added After
the Initial File Load            (0-1Giga)[0] : 0

❽ Key 0 Load Fill Percent        (50-100)[100] : 100
❾ (Fixed Variable)
Record Format                      (Keyword)[Var] : VARIABLE
❿ Mean Record Size                (1-32229)[-] : 80
```

(continued on next page)

# Creating and Populating Files

## 4.1 File Creation Characteristics

### Example 4-1 (Cont.) Sample Edit/FDL Utility Session

```

15 Maximum Record Size          (0,80-32229)[0] : 0

16 (Bin2 Bin4 Bin8 Int2 Int4 Int8 Decimal String Collated
    Dbin2 Dbin4 Dbin8 Dint2 Dint4 Dint8 Ddecimal Dstring Dcollated)
    Key 0 Data Type          (Keyword)[Str] : STRING
17 Key 0 Segmentation desired (Yes/No)[No] : NO
18 Key 0 Length              (1-255)[-]   : 9
19 Key 0 Position            (0-32220)[0]  : 0
20 Key 0 Duplicates allowed  (Yes/No)[No] : NO
21 File Prolog Version       (0-3)[3]    : 3
22 Data Key Compression desired (Yes/No)[Yes] : YES
23 Data Record Compression desired (Yes/No)[Yes] : YES
24 Index Compression desired  (Yes/No)[Yes] : YES

*
9 |
8 |
7 | Index
6 |
5 | Depth
4 |
3 | 3 3
2 | 2 2 2 2 2 2 2 2 2 2 2 2 2 2 2 2 2 2 2 2 2 2 2 2 2 2 2 2 2 2 2 2
1 | 1 1 1 1 1 1 1 1 1 1 1 1 1 1 1 1 1 1 1 1 1 1 1 1 1 1 1 1 1 1 1 1 1 1 1 1
  | +-+ +--+ -+ -+ -+ -+ -+ -+ -+ -+ -+ -+ -+ -+ -+ -+ -+ -+ -+ -+ -+ -+ -+ -+ -+ -+ -+ -+ -+ -+ -+ -+ -+ -+
  | 1 5 10 15 20 25 30 32
25 | Bucket Size (number of blocks)

    PV-Prolog Version      3 KT-Key 0 Type      String EM-Emphasis Flatter ( 3)
    DK-Dup Key 0 Values    No KL-Key 0 Length    9 KP-Key 0 Position    0
    RC-Data Record Comp    0% KC-Data Key Comp    0% IC-Index Record Comp 0%
    BF-Bucket Fill          100% RF-Record Format Variable RS-Mean Record Size 80
    LM-Load Method Fast Conv IL-Initial Load 100000 AR-Added Records 0
    (Type "FD" to Finish Design)
26 Which File Parameter (Mnemonic)[refresh] : FD
27 Text for FDL Title Section (1-126 chars)[null]
   : FDL_SESSION_EXAMPLE
28 Data File file-spec (1-126 chars)[null]
   : EXAMPLE.DAT
29 (Carriage Return Fortran None Print)
    Carriage Control (Keyword)[Carr] : CARRIAGE_RETURN

    Emphasis Used In Defining Default: ( Flatter_files )
    Suggested Bucket Sizes: ( 3 3 27 )
30 Number of Levels in Index: ( 2 2 1 )
    Number of Buckets in Index: ( 72 72 1 )
    Pages Required to Cache Index: ( 216 216 27 )
    Processing Used to Search Index: ( 168 168 766 )
31 Key 0 Bucket Size (1-63)[3] : 3
32 Key 0 Name (1-32 chars)[null]
   : SSNUM

```

(continued on next page)

## Creating and Populating Files

### 4.1 File Creation Characteristics

#### Example 4–1 (Cont.) Sample Edit/FDL Utility Session

```
33 Global Buffers desired          (Yes/No)[No]   : NO
34 The Depth of Key  0 is Estimated to be No Greater
   than 2 Index levels, which is 3 Total levels.
35 Press RETURN to continue (^Z for Main Menu)

                               OpenVMS FDL Editor

Add      to insert one or more lines into the FDL definition
Delete   to delete one or more lines from the FDL definition
Exit     to leave the FDL Editor after creating the FDL file
36 Help   to obtain information about the FDL Editor
Invoke   to initiate a script of related questions
Modify   to change existing line(s) in the FDL definition
Quit     to abort the FDL Editor with no FDL file creation
Set      to specify FDL Editor characteristics
View     to display the current FDL Definition
37 Main Editor Function          (Keyword)[Help] : EXIT
38 DISK$:[FOX.RMS]FDL_SESSION_EXAMPLE.FDL;1 40 lines
```

- 1 The Main Editor Function menu displays the Edit/FDL utility commands.
- 2 The INVOKE command displays the Script Title Selection menu. Note that HELP is the default command so if you want online help, just press the Return key.
- 3 The Script Title Selection menu shows the seven scripts you can choose to help you design your file. There is no default so you must explicitly select one of the scripts.
- 4 Choose the INDEXED script to design an indexed data file.
- 5 Choose a disk cluster size of three.
- 6 Define only one key—the primary key.
- 7 This menu provides a selection of graphic display types.
- 8 Select a line plot display.
- 9 Select 100,000 records to be loaded initially.
- 10 Select the CONVERT/FAST\_LOAD method of loading records into the data file.
- 11 Opt for no additional records after the initial load.
- 12 Elect a fill level of 100 percent for the primary index buckets.
- 13 Choose the variable-length record format.
- 14 Select an average record size of 80 characters.
- 15 Select an unlimited maximum record size.
- 16 Select the string data type for the primary key.

---

#### Note

---

The string data-type keys include STRING, DSTRING, COLLATED and DCOLLATED keys.

---

## Creating and Populating Files

### 4.1 File Creation Characteristics

- 17 Opt to disallow segmentation in the primary key.
- 18 Set the length of the primary key to 9 bytes.
- 19 Define the initial position of the primary key at column 0.
- 20 Opt to disallow duplicates of the primary key.
- 21 Choose the Prolog 3 version.
- 22 Select data key compression.
- 23 Select data record compression.
- 24 Select index compression.
- 25 This is a line plot showing bucket size against index depth.
- 26 Type “FD” to finish the design session.
- 27 Enter the title of your FDL file specification.
- 28 Enter the file specification of your data file.
- 29 Select the CARRIAGE\_RETURN carriage control.
- 30 This display shows the tuning emphasis you chose to design your file. It also shows suggested bucket sizes for various index level depths and other tuning information.
- 31 Select the default bucket size for the primary key.
- 32 Enter the name of the primary key.
- 33 Choose whether you want global buffers.
- 34 This message shows the depth of the primary key index and gives the total number of levels.
- 35 Press the Return key to display the main menu.
- 36 This is the main menu.
- 37 Use the EXIT command to exit the editor and to create the FDL file.
- 38 This message shows the resulting FDL file specification and the number of lines it contains.

Note that the example uses most of the suggested defaults. There are three ways to accept defaults:

- Press the Return key without entering a value.
- Use the /RESPONSES=AUTOMATIC qualifier when you invoke the Edit/FDL utility.
- Use the following sequence:
  1. Select the SET command from the main menu.
  2. Select RESPONSES from the SET menu.
  3. Accept the default (AUTO) when the Edit/FDL utility prompts for “Default responses in script.”

Key compression and index compression are not acceptable options when you select a collated key data type.

## Creating and Populating Files

### 4.1 File Creation Characteristics

When the Edit/FDL utility creates an FDL file, it groups the attributes into major sections. The section headings are called *primary attributes*, and the attributes within a primary section are called *secondary attributes*. Certain secondary attributes contain a third level of attributes called *qualifiers*.

The objective of using the Edit/FDL utility is to create an FDL file with optimum values for the various attributes. An FDL file contains a list of the primary and secondary attributes with related qualifiers. If a primary or secondary attribute does not appear in the FDL file, it is assigned its default value.

Example 4–2 shows an FDL file. IDENT, SYSTEM, FILE, RECORD, AREA n, and KEY n are primary attributes; the others are secondary attributes.

#### Example 4–2 Sample FDL File

```
IDENT
" 1-MAR-1993 14:07:46   OpenVMS FDL Editor"
SYSTEM
SOURCE                VMS
FILE
  GLOBAL_BUFFER_COUNT 0
  NAME                 DISK$RMS:[RMSTEST]INDEXED.DAT;3
  ORGANIZATION         indexed
  OWNER                [RMS1,TEST]
  PROTECTION           (system:RWED, owner:RWED, group:RE, world:)
RECORD
  BLOCK_SPAN           yes
  CARRIAGE_CONTROL     none
  FORMAT               variable
  SIZE                 2048
AREA 0
  ALLOCATION             233
  BEST TRY CONTIGUOUS  yes
  BUCKET SIZE          5
  EXTENSION            60
AREA 1
  ALLOCATION             5
  BEST TRY CONTIGUOUS  yes
  BUCKET SIZE          5
  EXTENSION            5
AREA 2
  ALLOCATION             18
  BEST TRY CONTIGUOUS  yes
  BUCKET SIZE          3
  EXTENSION            6
```

(continued on next page)

## Creating and Populating Files

### 4.1 File Creation Characteristics

#### Example 4–2 (Cont.) Sample FDL File

```
KEY 0
    CHANGES                no
    DATA AREA              0
    DATA_FILL              100
    DATA_KEY_COMPRESSION  no
    DATA_RECORD_COMPRESSION no
    DUPLICATES              no
    INDEX AREA              1
    INDEX_COMPRESSION       no
    INDEX_FILL              100
    LEVEL1_INDEX_AREA       1
    NAME                    "NUM"
    NULL KEY                 no
    PROLOG                   3
    SEGO_LENGTH              8
    SEGO_POSITION           0
    TYPE                     bin8

KEY 1
    CHANGES                yes
    DATA AREA              2
    DATA_FILL              100
    DATA_KEY_COMPRESSION  yes
    DUPLICATES              yes
    INDEX AREA              2
    INDEX_COMPRESSION       yes
    INDEX_FILL              100
    LEVEL1_INDEX_AREA       2
    NAME                    "NAME"
    NULL KEY                 yes
    NULL_VALUE              0
    SEGO_LENGTH              39
    SEGO_POSITION           9
    TYPE                     string
```

#### 4.1.2.2 Designing an FDL File

When you want to create an FDL file, you invoke the Edit/FDL utility with a DCL command in the following form:

```
EDIT/FDL/CREATE fdl-filespec
```

The /CREATE qualifier specifies that you want to create an FDL file with the name entered in the **fdl-filespec** parameter. When the Edit/FDL utility displays the main menu, select the INVOKE command. In response to the INVOKE command, the Edit/FDL utility prompts you for a script. The only appropriate scripts for creating a file are INDEXED, RELATIVE, and SEQUENTIAL.

As discussed previously, you can enter a script directly by specifying the /SCRIPT qualifier on the DCL command line. For example, enter the following command to create an indexed FDL file:

```
$ EDIT/FDL/CREATE/SCRIPT=INDEXED MY_FDL_FILE
```

When you select the script, the Edit/FDL utility prompts you for information about the data file. Each prompt consists of a short question, a range of acceptable values (for example, 50-100) or the value type (for example, Keyword, YES/NO, and so forth) in parentheses, and the default answer in brackets. One of the questions in the INDEXED script is shown as follows:

```
Number of Keys to Define (1-255)[1] :
```

In this example, the Edit/FDL utility prompts you for the number of keys you want to define for an indexed data file. The Edit/FDL utility accepts any number from 1 to 255. If you do not specify a value, it assumes that you want to define one key only, the primary key. To accept the default value, press the Return key.

If the Edit/FDL utility requires that you enter a value (that is, no default value is specified for the response), it includes a dash within brackets [-].

When you specify the SEQUENTIAL script or the RELATIVE script, the Edit/FDL utility returns you to the main menu level after finishing the dialog. When you specify the INDEXED script, one of the prompts requests your choice of a design graphics display: a Line\_Plot graph or a Surface\_Plot graph. After finishing the dialog, the Edit/FDL utility displays the selected graph to help you make your final design choice.

The Line\_Plot graph plots bucket size against index depth. All things equal, the size of the buckets determines the number of levels in the index, and the number of levels has a direct effect on the run-time performance of an indexed file. Fewer levels generally reduce the average number of keys searched when the index tree is traversed. However, fewer levels imply more records per data bucket and may cause longer data bucket search times. Thus, the Line\_Plot graph helps you decide on the best bucket size for your application. Figure 4–1 shows a Line\_Plot graph.

**Figure 4–1 Line\_Plot Graph**

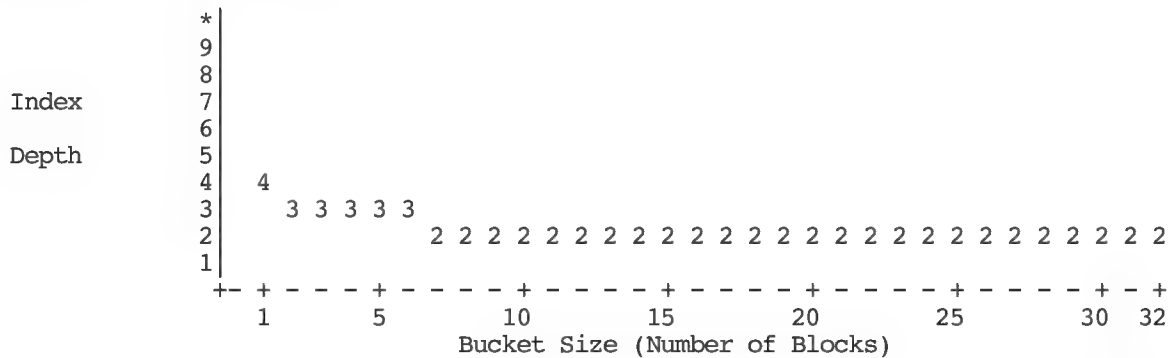

ZK-0980-GE

As shown in Figure 4–1, a bucket size of 1 block results in an index with five levels. Increasing the bucket size to 2 blocks reduces the number of index levels to four, but an increase to 5 blocks does not reduce the number of index levels at all. A bucket size of 7 blocks, however, reduces the number of index levels to three.

When you choose the bucket size, remember that the graphs do not display the data level. For example, if you want three levels in the file, then you must limit the number of index levels to two.

The Surface\_Plot graphics mode lets you choose a range of values to see their effects. The Edit/FDL utility prompts you to enter a lower and upper bound for one of the following values:

- Load fill percent
- Key length
- Record size



**Figure 4-3 Design Mnemonics**

```

PV-Prologue Version      3 KT-Key 0   Type      String  FD-Final Design Phase
DK-Dup Key 0   Values  No  KL-Key 0   Length      10  KP-Key 0   Position    0
RC-Data Record Comp    0%  KC-Data Key Comp    0%  IC-Index Record Comp    0%
RF-Record Format Variable RS-Mean Record Size    256
LM-Load Method Fast Conv IL-Initial Load    50000 AR-Added Records    5000
      Which File PaFameter      (Mnemonic)[refresh]      :
```

ZK-0950-GE

During the final design phase, the Edit/FDL utility gives you an opportunity to supply values for such attributes as TITLE, an optional primary that allows you to label the FDL file. (Most of these questions are also applicable to designing sequential and relative files.) When you have answered the questions, the Edit/FDL utility assigns the values to the FDL attributes and returns you to the main menu level to display the resulting FDL file.

At the main menu, you can select the ADD command to assign values to any attribute the script omitted. Remember that if an attribute does not appear in the FDL file, it assumes the default value. (For a list of the default values for each attribute, see the *OpenVMS Record Management Utilities Reference Manual*.) To modify an attribute, use the MODIFY command, and to delete an attribute, use the DELETE command.

To create the displayed FDL file, select the EXIT command. To abort the session without creating an FDL file, select the QUIT command.

### 4.1.3 Using the FDL Routines

You can also define file-creation characteristics with the FDL utility routines. The FDL routines provide you with the functions of the File Definition Language, and they allow you to set file creation characteristics from within your application.

There are four FDL routines:

|               |   |
|---------------|---|
| FDL\$CREATE   | Creates a file from an FDL specification, and then closes the file. See Section 4.2.4 for more information.   |
| FDL\$GENERATE | Produces an FDL specification by interpreting a set of control blocks. It then writes the FDL specification either to an FDL file or to a character string.   |
| FDL\$PARSE    | Parses an FDL specification, allocates control blocks, and then fills in the relevant fields.   |
| FDL\$RELEASE  | Deallocates the virtual memory used by the control blocks created by FDL\$PARSE. You must use FDL\$PARSE to fill in (to populate) the control blocks if you plan to release the memory with FDL\$RELEASE later. |

Because the FDL\$GENERATE, FDL\$PARSE, and FDL\$RELEASE routines allow you to use the run-time, as well as the creation-time, features of RMS, you must call them from a language that can access the control block fields that specify the CONNECT options. This may be difficult from a high-level language.

Example 4-3 shows how to call the FDL\$PARSE and FDL\$GENERATE routines from a Pascal program.

## Creating and Populating Files

### 4.1 File Creation Characteristics

#### Example 4-3 Using FDL Routines in a Pascal Program

```
[INHERIT ('SYS$LIBRARY:STARLET')]
PROGRAM example2 (input,output,order_master);

(* This program fills in its own FAB, RAB, and *)
(* XABS by calling FDL$PARSE and then generates *)
(* an FDL specification by calling FDL$GENERATE. *)
(* It requires an existing input FDL file *)
(* (TESTING.FDL) for FDL$PARSE to parse. *)

TYPE
(**+ *)
(* FDL CALL INTERFACE CONTROL FLAGS *)
(**- *)
    $BIT1 = [BIT(1),UNSAFE] BOOLEAN;

    FDL2$TYPE = RECORD CASE INTEGER OF
    1: (FDL$_FDLDEF_BITS : [BYTE(1)] RECORD END;
    );
    2: (FDL$V SIGNAL : [POS(0)] $BIT1;
    (* Signal errors; don't return *)
    FDL$V FDL_STRING : [POS(1)] $BIT1;
    (* Main FDL spec is a char string *)
    FDL$V DEFAULT_STRING : [POS(2)] $BIT1;
    (* Default FDL spec is a char string *)
    FDL$V FULL_OUTPUT : [POS(3)] $BIT1;
    (* Produce a complete FDL spec *)
    );
    END;

    mail_order = RECORD
    order_num : [KEY(0)] INTEGER;
    name : PACKED ARRAY[1..20] OF CHAR;
    address : PACKED ARRAY[1..20] OF CHAR;
    city : PACKED ARRAY[1..19] OF CHAR;
    state : PACKED ARRAY[1..2] OF CHAR;
    zip_code : [KEY(1)] PACKED ARRAY[1..5]
    OF CHAR;
    item_num : [KEY(2)] INTEGER;
    shipping : REAL;
    END;

    order_file = [UNSAFE] FILE OF mail_order;
    ptr_to_FAB = ^FAB$TYPE;
    ptr_to_RAB = ^RAB$TYPE;
    byte = 0..255;

VAR
    order_master : order_file;
    flags : FDL2$TYPE;
    order_rec : mail_order;
    temp_FAB : ptr_to_FAB;
    temp_RAB : ptr_to_RAB;
    status : integer;

FUNCTION LIB$SIGNAL
    (%REF cond val: INTEGER;
    %IMMED num: INTEGER := %immed 0;
    %STDESCR s1: PACKED ARRAY[L1..U1: INTEGER] OF CHAR := %IMMED 0;
    %STDESCR s2: PACKED ARRAY[L2..U2: INTEGER] OF CHAR := %IMMED 0): INTEGER;
    EXTERN;
```

(continued on next page)

**Example 4–3 (Cont.) Using FDL Routines in a Pascal Program**

```
FUNCTION FDL$PARSE
  (%STDESCR FDL_FILE : PACKED ARRAY [L1..U1:INTEGER]
   OF CHAR;
   VAR FAB_PTR : PTR_TO_FAB;
   VAR RAB_PTR : PTR_TO_RAB) : INTEGER; EXTERN;
FUNCTION FDL$GENERATE
  (%REF FLAGS : FDL2$TYPE;
   FAB_PTR : PTR_TO_FAB;
   RAB_PTR : PTR_TO_RAB;
   %STDESCR FDL_FILE_DST : PACKED ARRAY [L1..U1:INTEGER]
   OF CHAR) : INTEGER;
  EXTERN;
BEGIN
  status := FDL$PARSE ('TESTING',TEMP_FAB,TEMP_RAB);
  if not odd (status) then LIB$SIGNAL(status);
  flags::byte := 0;
  status := FDL$GENERATE (flags,
                        temp_FAB,
                        temp_RAB,
                        'SYS$OUTPUT:');
  if not odd (status) then LIB$SIGNAL(status);
END.
```

For more information about FDL routines, see the *OpenVMS Utility Routines Manual*.

## 4.2 Creating a File

After you select the creation characteristics for your file, you use the selected characteristics to create the file. You can create the file using one of the following:

- Create service
- Create/FDL utility
- Convert utility
- FDL\$CREATE routine

### 4.2.1 Using the Create Service

The Create service creates a new data file assigning it the attributes you specify in the FAB and any applicable XABs. Note that where there is a conflict, the XAB fields override the FAB fields.

When you use the Create service to create a file, the file remains open until you explicitly close it.

If you set the create-if (CIF) bit in the FOP (file-processing options) field of the FAB, you can open an existing file with the Create service. If the file you try to create has the same name as an existing file, the Create service opens the existing file instead of creating the new file.

The Create service allows you to set file-creation characteristics and to create the file directly from your application program.

For more information about the Create service, see the *OpenVMS Record Management Services Reference Manual*.

## Creating and Populating Files

### 4.2 Creating a File

#### 4.2.2 Using the Create/FDL Utility

Unlike the Create service, using FDL to create a file is a two-step process. You must first create the FDL file using the Edit/FDL utility and then use another RMS utility or your application program to create the data file.

One of the utilities you can use to create a file is the Create/FDL utility (CREATE/FDL). CREATE/FDL creates an empty data file from the specifications in an existing FDL file. This feature allows you to use the Edit/FDL utility to create standard FDL files that describe commonly needed data files and then to use CREATE/FDL to create the data files as they are needed.

For example, to create an empty data file called CUSTRECS.DAT from the specifications in an FDL file called INDEXED.FDL, enter the following DCL command:

```
$ CREATE/FDL=INDEXED.FDL CUSTRECS.DAT
```

#### 4.2.3 Using the Convert Utility

Another RMS utility that creates an output data file from the specifications in an FDL file is the Convert utility (CONVERT). However, instead of being empty, the new output file generally contains data records from the input file unless the input file was also empty. Note that the Convert utility processes relative files by sequentially reading records from the input file, then writing them to the output file. As a result the relative record numbers (RRN) change when the input file contains deleted or unused records.

If you want to use CONVERT to change the characteristics of a particular file, you can use a DCL command of the following form:

```
CONVERT/FDL=fdl-file input-file output-file
```

The CONVERT/FDL command creates a new file named by the **output-file** parameter and assigns the new file the characteristics specified in the FDL file.

For more information about populating data files with CONVERT, see Section 4.5.

#### 4.2.4 Using the FDL\$CREATE Routine

You can also create data files according to your specifications with the FDL\$CREATE routine. FDL\$CREATE is the FDL routine most likely to be called from a high-level language. It creates a file from an FDL specification and then closes the file.

The FDL\$CREATE routine performs the same function as the Create/FDL utility, but it allows you to create data files from your application. However, it allows you to use only the creation-time features of RMS.

Example 4-4 shows how to call the FDL\$CREATE routine from a Fortran program.

**Example 4-4 Using the FDL\$CREATE Routine in a Fortran Program**

```

*      This program calls the FDL$CREATE routine.  It
*      creates an indexed output file named NEW MASTER.DAT
*      from the specifications in the FDL file named
*      INDEXED.FDL.  You can also supply a default file name
*      and a result name (which receives the name of the created
*      file).  The program also returns all statistics.
*
      IMPLICIT      INTEGER*4      (A - Z)
      EXTERNAL     LIB$GET_LUN,    FDL$CREATE
      CHARACTER    IN_FILE*11     /'INDEXED.FDL'/,
      1           OUT_FILE*14     /'NEW MASTER.DAT'/,
      1           DEF_FILE*11     /'DEFAULT.FDL'/,
      1           RES_FILE*50
      INTEGER*2    FIDBLK(3)      /0,0,0/
      I = 1
      STATUS = FDL$CREATE (IN_FILE,OUT_FILE,
                          DEF_FILE,RES_FILE,FIDBLK,,)
      IF (.NOT. STATUS) CALL LIB$STOP (%VAL(STATUS))
*
      STATUS=LIB$GET_LUN(LOG_UNIT)
      OPEN (UNIT=LOG_UNIT,FILE=RES_FILE,STATUS='OLD')
      CLOSE (UNIT=LOG_UNIT, STATUS='KEEP')
*
      WRITE (6,1000) (RES_FILE)
      WRITE (6,2000) (FIDBLK (I), I=1,3)
*
1000  FORMAT (1X,'The result filename is: ',A50)
*
2000  FORMAT (/1X,'FID-NUM: ',I5/,
      1      1X,'FID-SEQ: ',I5/,
      1      1X,'FID-RVN: ',I5)
*
      END

```

Example 4-5 shows how to call the FDL\$CREATE routine from a COBOL program.

## Creating and Populating Files

### 4.2 Creating a File

#### Example 4-5 Using the FDL\$CREATE Routine from a COBOL Program

```
*          FDLCR.COB
*
*          This program calls the FDL$CREATE routine.  It creates
*          an indexed output file named NEW_MASTER.DAT from the
*          specifications in the FDL file named INDEXED.DAT.  You
*          can also supply a default file name and a result name
*          (that receives the name of the created file).  The
*          program also returns the FDL$CREATE statistics.
*
*          DATA NAMES:
*
*          OUT-REC    defines the output record
*          STATVALUE  receives the status value from the routine
*                   call
*          NORMAL     receives the value from SS$ NORMAL
*          FIDBLOCK   receives the FDL$CREATE statistics.  There
*                   are three:
*                   (1) file identification number (FID-NUM)
*                   (2) file sequence number      (FID-SEQ)
*                   (3) relative volume number    (RVN)
*          RESNAME    receives the name of the file that is created
*                   (the result file name)
*
IDENTIFICATION DIVISION.
PROGRAM-ID. FDL-CREATE-EXAMPLE.

ENVIRONMENT DIVISION.
CONFIGURATION SECTION.
SOURCE-COMPUTER. VAX
OBJECT-COMPUTER. VAX
INPUT-OUTPUT SECTION.
FILE-CONTROL.
        SELECT OUT-FILE ASSIGN TO 'NEWMASTER.DAT'.

DATA DIVISION.
FILE SECTION.
FD          OUT-FILE
        DATA RECORD IS OUT-REC.

01          OUT-REC.
        02          OUT-NUM      PIC X(4).
        02          OUT-NAME     PIC X(20).
        02          OUT-COLOR    PIC X(4).
        02          OUT-WEIGHT   PIC X(4).
        02          SUPL-NAME    PIC X(20).
        02          FILLER       PIC X(28).

WORKING-STORAGE SECTION.
01          MORE-DATA-FLAGS     PIC XXX      VALUE 'YES'.
        88          THERE-IS-DATA VALUE 'YES'.
        88          THERE-IS-NO-DATA VALUE 'NO '.

01          STATVALUE          PIC S9(9)    COMP.

01          FIDBLOCK           USAGE IS COMP.
        02          NUM         PIC S9(9)    VALUE 0.
        02          SEQ         PIC S9(9)    VALUE 0.
        02          RVN         PIC S9(9)    VALUE 0.

01          RESNAME            PIC X(50).
```

(continued on next page)

**Example 4–5 (Cont.) Using the FDL\$CREATE Routine from a COBOL Program**

```
PROCEDURE DIVISION.  
MAIN.  
    PERFORM CREATE-FILE THRU DISPLAY-STATS.  
    STOP RUN.  
  
CREATE-FILE.  
    CALL 'FDL$CREATE' USING BY DESCRIPTOR 'INDEXED.FDL'  
                           BY DESCRIPTOR 'NEWMMASTER.DAT'  
                           BY DESCRIPTOR 'DEFAULT.DAT'  
                           BY DESCRIPTOR RESNAME  
                           BY REFERENCE FIDBLOCK  
                           BY VALUE 0  
                           BY VALUE 0  
                           BY VALUE 0  
                           BY VALUE 0  
                           BY VALUE 0  
                           GIVING STATVALUE.  
  
    IF STATVALUE IS FAILURE  
    CALL 'LIB$STOP' USING BY VALUE STATVALUE.  
  
DISPLAY-STATS.  
    DISPLAY 'The result filename is: ',RESNAME CONVERSION.  
    DISPLAY 'FID number:           ',NUM CONVERSION.  
    DISPLAY 'FID sequence:         ',SEQ CONVERSION.  
    DISPLAY 'Volume number:       ',RVN CONVERSION.
```

### 4.3 Creating and Accessing Tagged Files

RMS supports the use of compound document text through the implementation of **tagged files**. The term **compound documents** refers to files that contain a number of integrated components including text, graphics, and scanned images.

Tagged files are made distinguishable by the RMS file attribute **stored semantics**. The value of the stored semantics attribute is called the file **tag**, and it specifies how file data is to be interpreted.

RMS support for compound document text requires that compound document files be tagged with the appropriate stored semantics values. These are binary values that can be up to 64 bytes long and can be expressed using hexadecimal notation. The hexadecimal value of the DDIF tag, for example, is 2B0C8773010301. The operating system lets you assign names to tag values so that DCL commands such as DIRECTORY/FULL and utilities such as FDL and ANALYZE/RMS\_FILE display a more easily remembered mnemonic for the DDIF tag instead of the hexadecimal value.

Assigning a name to the tag also aids in using the /SEMANTICS qualifier with the DCL SET FILE command when you want to tag a file from the DCL interface. For example, you can use a command like the following:

```
$ SET FILE/SEMANTICS=DDIF MY.FILE
```

To assign a tag a name, you must have privileges to make appropriate entries in two system tables, RMS\$SEMANTIC\_TAGS and RMS\$SEMANTIC\_OBJECTS.

## Creating and Populating Files

### 4.3 Creating and Accessing Tagged Files

For example, the following DCL commands have been included in the system startup command file to assign the mnemonic DDIF to the hexadecimal value for a DDIF tag:

```
$ DEFINE/TABLE=RMS$SEMANTIC_TAGS DDIF 2B0C8773010301
$ DEFINE/TABLE=RMS$SEMANTIC_OBJECTS 2B0C8773010301 DDIF
```

With the appropriate DEFINE commands, you can assign mnemonics for other tags, including tags used with international program applications.

You can tag files through the DCL interface, the FDL interface, or from your program by way of the RMS interface. This section describes the implementation of tagged files through the RMS interface including:

- Tagging files
- Accessing tagged files
- Preserving tags

#### 4.3.1 Programming Interface for File Tagging

You can tag a file from the RMS interface by using the Create service in conjunction with an item XAB (`$XABITM`). See *OpenVMS Record Management Services Reference Manual* for more information about using the `$XABITM` macro.

Example 4–6 illustrates a BLISS–32 program that tags a DDIF file through the RMS interface. The tag value shown is a 7-byte hexadecimal number representing the code for the DDIF tag. The RMS program interface accepts only hexadecimal tag values.

To write to a tagged file, the application program must use a `$XABITM` macro to specify access semantics that match the file's stored semantics as established by a `$XABITM` macro. As shown in the example, the Create service tags the file and the Connect service specifies the appropriate access semantics.

## Creating and Populating Files

### 4.3 Creating and Accessing Tagged Files

#### Example 4-6 Tagging a File

```
MODULE TYPE$MAIN (
    IDENT = 'X-1',
    MAIN = MAIN,
    ADDRESSING_MODE (EXTERNAL=GENERAL)
) =
BEGIN
!
! FORWARD ROUTINE
    MAIN : NOVALUE;                                ! Main routine
!
! INCLUDE FILES:
!
LIBRARY 'SYS$LIBRARY:LIB';
OWN
    NAM          : $NAM(),
    RETLEN,
    DDIF_TAG     : BLOCK[ 7, BYTE]
    INITIAL( BYTE( %X'2B', %X'0C', %X'87', %X'73', %X'01', %X'03', %X'01')),
    FAB_XABITM   :
        $xabitm
        ( itemlist=
            $ITMLST_UPLIT
            (
                (ITMCOD=XAB$ _STORED_SEMANTICS,
                 BUFADR=DDIF_TAG,
                 BUFSIZ=%ALLOCATION(DDIF_TAG))
            ),
            mode = SETMODE),
    RAB_XABITM   :
        $xabitm
        ( itemlist=
            $ITMLST_UPLIT
            (
                (ITMCOD=XAB$ _ACCESS_SEMANTICS,
                 BUFADR=DDIF_TAG,
                 BUFSIZ=%ALLOCATION(DDIF_TAG))
            ),
            mode = SETMODE),
    FAB         : $FAB( fnm = 'TAGGED-FILE.TEST',
        nam = NAM,
        mrs = 512,
        rfm = FIX,
        fac = <GET,PUT,UPD>,
        xab = FAB XABITM),
    REC         : BLOCK[512,BYTE],
    STATUS,
    RAB         : $RAB( xab = RAB_XABITM,
        fab = FAB,
        rsz = 512,
        rbf = REC,
        usz = 512,
        ubf = REC),
    DESC       : BLOCK[8,BYTE] INITIAL(0);
ROUTINE MAIN : NOVALUE =
BEGIN
STATUS = $CREATE( FAB = FAB );
IF NOT .STATUS
THEN
    SIGNAL (.STATUS);
STATUS = $CONNECT( RAB = RAB );
```

(continued on next page)

## Creating and Populating Files

### 4.3 Creating and Accessing Tagged Files

#### Example 4–6 (Cont.) Tagging a File

```
IF NOT .STATUS
THEN
    SIGNAL (.STATUS);
STATUS = %CLOSE( FAB = FAB );
IF NOT .STATUS
THEN
    SIGNAL (.STATUS);
END;
END
ELUDOM
```

#### 4.3.2 Accessing a Tagged File

This section details how RMS handles access to tagged files at the program level. When a program accesses a tagged file, RMS must determine whether and when to associate an **RMS extension** with the access. This is important to the programmer because an RMS extension can change the attributes of the accessed file.

RMS extensions are system images that perform specialized file or record operations within the context of RMS. Record management services can invoke an extension if specified conditions are met. Functions provided by an extension are only accessible through the record management services and are generally transparent to the application.

An example of an RMS extension is the DDIF-to-ASCII text translator. RMS can call this extension to extract ASCII text from a DDIF file. The conditions that determine when this extension is called are described in this section.

A DDIF file is a sequentially organized file with 512-byte, fixed-length records. If the DDIF-to-ASCII RMS extension is used to extract text from a DDIF file, the accessed file appears as a sequentially organized file having variable-length records with a maximum record size of 2048 bytes and an implicit carriage return.

One consideration in determining whether an access requires the RMS extension is the type of access (FAB\$B\_FAC). When an application program opens a file through the RMS program interface, it must specify if it will be doing record I/O (default), block I/O (BIO), or mixed I/O (BRO) operations, where the program has the option of using either block I/O or record I/O for each access. For example, if block I/O operations are specified, RMS does not associate the RMS extension with the file access.

Another consideration is whether the program senses the tag when it opens a file. If the program does not sense the tag when it opens a DDIF file for record access, RMS associates the RMS extension with the file access during the Open service and returns the file attributes that have been modified by the extension.

The final consideration is the access semantics that the program specifies and the file's stored semantics (tag). If the program specifies block I/O (FAB\$V\_BIO) operations, RMS does not associate the RMS extension with the file access and the Open service returns the file's stored attributes to the accessing program regardless of whether the program senses tags.

## Creating and Populating Files

### 4.3 Creating and Accessing Tagged Files

#### 4.3.2.1 File Accesses That Do Not Sense Tags

This section describes what happens when a program does not use a XABITM control block to sense a tag when it opens a file.

When a program opens a DDIF file for record operations and does not sense the tag, RMS assumes that the program wants to access text in the file. In this case, RMS associates the RMS extension with the file access, which provides file attributes that correspond to record-mode access.

When a program opens a DDIF file with the FAB\$V\_BRO option and does not sense the tag, any subsequent attempt to use block I/O fails. If the program specifies block I/O (FAB\$V\_BIO) when it invokes the Connect service, the operation fails because the file attributes returned at Open permit record access only. Similarly, if the program specifies the FAB\$V\_BRO option when it opens the file and then specifies mixed mode (block/record) operations by not specifying RAB\$V\_BIO at connect time, block operations such as READ and WRITE are disallowed.

#### 4.3.2.2 File Accesses That Sense Tags

RMS does not associate the RMS extension with the file access as part of the Open service if a program opens a DDIF file and senses the stored semantics. This allows the program to specify access semantics with the Connect service. RMS returns the file attributes, including the stored semantics attribute (tag value), to the program as part of the Open service.

When the program subsequently invokes the Connect service, RMS uses the specified operations mode to determine its response. If the program specified FAB\$V\_BRO with the Open service and then specifies block I/O (RAB\$V\_BIO) when it invokes the Connect service, RMS does not associate the RMS extension with the file access.

But, if the program specifies record access or FAB\$V\_BRO when it opens the file and then decides to use record I/O when it invokes the Connect service, RMS compares the access semantics with the file's stored semantics to determine whether to associate the RMS extension with the file access. If the access semantics match the stored semantics, RMS does not associate the RMS extension with the file access. If the access semantics do not match the stored semantics, RMS associates the RMS extension with the file access. In this case, the program must use the Display service to obtain the modified file attributes. If RMS cannot find the appropriate RMS extension, the operation fails and the Connect service returns the EXTNOTFOU error message.

If the application program senses the file's stored semantics, RMS allows mixed-mode operations. In this case, mixed block and record operations are permitted because the application gets record mode file attributes and data from the RMS extension and block mode file attributes and data from the file.

Example 4-7 illustrates a BLISS-32 program that accesses a tagged file from an application program that does not use an RMS extension.

## Creating and Populating Files

### 4.3 Creating and Accessing Tagged Files

#### Example 4-7 Accessing a Tagged File

```

MODULE TYPE$MAIN (
    IDENT = 'X-1',
    MAIN = MAIN,
    ADDRESSING_MODE (EXTERNAL=GENERAL)
) =
BEGIN
!
! FORWARD ROUTINE
    MAIN : NOVALUE;                                ! Main routine
!
! INCLUDE FILES:
!
LIBRARY 'SYS$LIBRARY:STARLET';
OWN
    NAM          : $NAM(),
    ITEM_BUFF    : BLOCK[ XAB$K_SEMANTICS_MAX_LEN, BYTE ],
    RETLEN,
    FAB_XABITM   :
        $xabitm
        ( itemlist=
            $ITMLST UPLIT
            ((ITM$W_ITEM = XAB$K_SEMANTICS_MAX_LEN,
              BUFADR=ITEM_BUFF,
              BUFSIZ=XAB$K_SEMANTICS_MAX_LEN,
              RETLEN=RETLEN)),
            mode = SENSEMODE),
    RAB_ITEMLIST : BLOCK[ ITM$W_ITEM + 4, BYTE ],
    RAB_XABITM   : $XABITM
        ( itemlist=RAB_ITEMLIST,
          mode=SETMODE),
    FAB          : $FAB( fnm = 'TAGGED-FILE.TEST',
                        nam = NAM,
                        fac = <GET,PUT,UPD>,
                        xab = FAB_XABITM),
    REC          : BLOCK[512, BYTE],
    STATUS,
    RAB          : $RAB( xab = RAB_XABITM,
                        fab = FAB,
                        rsz = 512,
                        rbf = REC,
                        usz = 512,
                        ubf = REC),
    DESC        : BLOCK[8, BYTE] INITIAL(0);
ROUTINE MAIN : NOVALUE =
BEGIN
STATUS = $OPEN( FAB = FAB );
IF NOT .STATUS
THEN
    SIGNAL (.STATUS);
RAB_ITEMLIST[ ITM$W_BUFSIZ ] = .RETLEN;
RAB_ITEMLIST[ ITM$W_BUFADR ] = ITEM_BUFF;
RAB_ITEMLIST[ ITM$W_ITM$W_ITEM ] = XAB$K_SEMANTICS_MAX_LEN;
STATUS = $CONNECT( RAB = RAB );
IF NOT .STATUS
THEN
    SIGNAL (.STATUS);
STATUS = $CLOSE( FAB = FAB );
IF NOT .STATUS
THEN
    SIGNAL (.STATUS);

```

(continued on next page)

**Example 4–7 (Cont.) Accessing a Tagged File**

```
END;  
END  
ELUDOM
```

### 4.3.3 Preserving Tags

In order to preserve the integrity of a tagged file that is being copied or transmitted, the tag must be preserved in the destination (output) file. The most efficient way to use the RMS interface for propagating tags involves a 2-step procedure:

1. Open the source file (input) and sense the tag using a \$XABITM macro with the item code XAB\$\_STORED\_SEMANTICS, as shown in the following example:

```
.  
. .  
ITEMLIST[ ITM$W_BUFSIZ ] = XAB$K_SEMANTICS_MAX_LEN;  
ITEMLIST[ ITM$L_BUFADR ] = ITEM_BUFF;  
ITEMLIST[ ITM$L_RETLEN ] = RETLEN;  
ITEMLIST[ ITM$W_ITMCO ] = XAB$_STORED_SEMANTICS;  
. .  
XABITM[ XAB$B_MODE ] = XAB$K_SENSEMODE;  
STATUS = $OPEN( FAB = FAB );  
. .  
.
```

2. Create the destination (output) file and set the tag using a \$XABITM macro with the item code XAB\$\_STORED\_SEMANTICS:

```
.  
. .  
IF .RETLEN GTR 0  
THEN  
  BEGIN  
    ITEMLIST[ ITM$W_ITMCO ] = XAB$_STORED_SEMANTICS;  
    ITEMLIST[ ITM$L_SIZE ] = .RETLEN;  
    XABITM[ XAB$B_MODE ] = XAB$K_SETMODE;  
  END;  
STATUS = $CREATE( FAB = FAB );  
. .  
END;  
END  
ELUDOM
```

## 4.4 Defining File Protection

You can protect a disk file in two ways:

- UIC-based protection codes
- Access control lists (ACLs)

## Creating and Populating Files

### 4.4 Defining File Protection

#### 4.4.1 UIC-Based Protection

You can protect the disk with UIC-based protect codes that are described in the *OpenVMS Guide to System Security*.

The owner UIC is normally the UIC of the person who created the file. The protection code indicates who is allowed access and what type of access they are permitted.

When you try to open a file, your UIC is compared to the owner UIC of the file. Depending on the relationship of the UICs, you might be classified under one or more of the following categories:

- System
- Owner
- Group
- World

Depending on your classification, you may be allowed or denied the following types of access:

|         |   |
|---------|---|
| Read    | Can examine, print, or copy a disk or tape file                 |
| Write   | Can modify or write to a disk or tape file                      |
| Execute | Can execute a disk file that contains executable program images |
| Delete  | Can delete a disk file  |

You can specify the UIC-based protection value you need when the file is created if you use either an FDL specification or RMS directly.

After you create a file, you can change its UIC-based protection with the DCL command SET PROTECTION. For more information about the SET PROTECTION command, see the *OpenVMS DCL Dictionary*.

The previous list omits CONTROL access because it is never specified in the standard UIC-based protection code. However, CONTROL access can be specified in an ACL and is automatically granted to certain user categories when UIC-based protection is evaluated.

CONTROL access grants the accessor all the privileges of the object's actual owner. For more information, see the documentation related to OpenVMS security.

#### 4.4.2 ACL-Based Protection

You can also protect disk files with access control lists (ACLs). (ACLs cannot be used with magnetic tape files.)

An ACL is a list of people or groups who are allowed to access a particular file. ACLs offer more scope than UICs in determining what action you want taken when someone tries to access your file. You can provide an ACL on any file to permit as much or as little access as you want.

You can specify the ACL for a file when you create it if you use RMS directly. You cannot specify an ACL in an FDL specification, and ACLs are not supported over DECnet.

After a file is created, you can define the access control list for it with the ACL Editor. You can invoke this editor with either of the following DCL commands:

- EDIT/ACL
- SET FILE/ACL

For more information about how to invoke, modify, and display ACLs, see the *OpenVMS System Management Utilities Reference Manual*. For additional information about operating system security features, see your system or security manager, or consult the documentation related to OpenVMS security.

## 4.5 Populating a File

The next two sections explain how to use the Convert utility to populate a file.

### 4.5.1 Using the Convert Utility

The Convert utility allows you to create and populate a file.

To create a file, you need an input data file and an FDL file that describes the output file you want to create. You issue a DCL command in the following form:

```
CONVERT/CREATE/FDL=fdl-file input-file output-file
```

As with the CREATE/FDL command, the CONVERT/CREATE/FDL command creates a file named by the **output-file** parameter and having characteristics specified in your FDL file. Unlike the CREATE/FDL command, CONVERT populates the output file with the records from the input file. For example, to create the file CUST.IDX from the specifications in the FDL file STDINDEX.FDL and copy the records from the input file CUST.SEQ into CUST.IDX, you enter the following command:

```
$ CONVERT/CREATE/FDL=STDINDEX.FDL CUST.SEQ CUST.IDX
```

RMS assigns the characteristics specified in the file STDINDEX.FDL to the records in CUST.IDX. Note that the Convert utility processes relative files by sequentially reading records from the input file, then writing them to the output file. As a result, the relative record numbers (RRN) change when the input file contains deleted or unused records.

### 4.5.2 Using the Convert Routines

You can invoke the functions of the Convert utility from your application program by calling the following series of convert routines:

|                    |  |
|--------------------|--|
| CONV\$PASS_FILES   | Names the files to be converted. You can also specify an FDL file.   |
| CONV\$PASS_OPTIONS | Indicates the CONVERT qualifiers that you want to use. You may specify any legal CONVERT option, or you may accept the defaults.   |
| CONV\$CONVERT      | Copies records from one or more source data files to an output data file. The output file is not required to have the same file organization and format as the source files. |

The routines must be called in this order.

Example 4–8 shows how to call the CONVERT routines from a Fortran program.

## Creating and Populating Files

### 4.5 Populating a File

#### Example 4–8 Using the CONVERT Routines in a Fortran Program

```
*           This program calls the routines that perform the
*           functions of the Convert utility.  It creates an
*           indexed output file named CUSTDATA.DAT from the
*           specifications in an FDL file named INDEXED.FDL.
*           The program then loads CUSTDATA.DAT with records
*
*           from the sequential file SEQ.DAT.  No exception
*           file is created.  This program also returns the
*           "BRIEF" CONVERT statistics.
*           Program declarations
*
      IMPLICIT      INTEGER*4 (A - Z)
*
*           Set up parameter list: number of options, CREATE,
*           NOSHARE, FAST LOAD, MERGE, APPEND, SORT, WORK_FILES,
*           KEY=0, NOPAD, PAD CHARACTER, NOTRUNCATE,
*           NOEXIT, NOFIXED CONTROL, FILL BUCKETS, NOREAD_CHECK,
*           NOWRITE_CHECK, FDL, and NOEXCEPTION.
*
      INTEGER*4      OPTIONS(19),
1 /18,1,0,1,0,0,1,2,0,0,0,0,0,0,0,0,0,0,1,0/
*
*           Set up statistics list as an array with the
*           number of statistics that requested.  There are
*           four: number of files, number of records, exception
*           records, and good records, in that order.
      INTEGER*4      STATSBLK(5) /4,0,0,0,0/
*
*           Declare the file names
      CHARACTER      IN_FILE*7  /'SEQ.DAT'/,
1                   OUT_FILE*12 /'CUSTDATA.DAT'/,
1                   FDL_FILE*11 /'INDEXED.FDL'/
*
*           Call the routines in their required order.
      STATUS = CONV$PASS FILES (IN_FILE, OUT_FILE, FDL_FILE)
      IF (.NOT. STATUS) CALL LIB$STOP (%VAL(STATUS))
      STATUS = CONV$PASS OPTIONS (OPTIONS)
      IF (.NOT. STATUS) CALL LIB$STOP (%VAL(STATUS))
      STATUS = CONV$CONVERT (STATSBLK)
      IF (.NOT. STATUS) CALL LIB$STOP (%VAL(STATUS))
*
*           Display the statistics information.
      WRITE (6,1000) (STATSBLK(I),I=2,5)
1000  FORMAT (1X,'Number of files processed: ',I5/,
1       1X,'Number of records: ',I5/,
1       1X,'Number of exception records: ',I5/,
1       1X,'Number of valid records: ',I5)
      END
```

## Creating and Populating Files 4.5 Populating a File

Example 4–9 shows how to call the CONVERT routines from a COBOL program.

### Example 4–9 Using the CONVERT Routines in a COBOL Program

```
*      CONV.COB
*
*      This program calls the routines that perform the
*      functions of the Convert utility. It creates an
*      indexed output file named CUSTDATA.DAT from the
*      specifications in an FDL file named INDEXED.FDL.
*      The program then loads CUSTDATA.DAT with records
*
*      from the sequential file SEQ.DAT. No exception
*      file is created. This program also returns the
*      "BRIEF" CONVERT statistics.
*
*
*      DATA NAMES:
*
*      IN-REC      defines the input record
*      OUT-REC     defines the output record
*      STATVALUE  receives the status value from the
*                routine call
*      NORMAL     receives the value from SS$ NORMAL
*      OPTIONS    defines the CONVERT parameter list
*      STATSBLK   receives the CONVERT statistics. The
*                first data field (NUM-STATS) contains
*                the total number of statistics requested.
*                There are four:
*                (1) number of files processed (NUM-STATS)
*                (2) number of records processed (NUM-FILES)
*                (3) number of exception records (NUM-RECS)
*                (4) number of valid records (NUM-VALRECS)
*
IDENTIFICATION DIVISION.
PROGRAM-ID. PARTS.

ENVIRONMENT DIVISION.
CONFIGURATION SECTION.
SOURCE-COMPUTER. VAX
OBJECT-COMPUTER. VAX
INPUT-OUTPUT SECTION.
FILE-CONTROL.
        SELECT IN-FILE ASSIGN TO SEQ.
        SELECT OUT-FILE ASSIGN TO CUSTDATA.

DATA DIVISION.
FILE SECTION.
FD      IN-FILE
        DATA RECORD IS IN-REC.

01      IN-REC.
        02      IN-NUM          PIC X(4).
        02      IN-NAME        PIC X(20).
        02      IN-COLOR       PIC X(4).
        02      IN-WEIGHT      PIC X(4).
        02      SUPL-NAME      PIC X(20).
        02      FILLER         PIC X(28).

FD      OUT-FILE
        DATA RECORD IS OUT-REC.
```

(continued on next page)

## Creating and Populating Files

### 4.5 Populating a File

#### Example 4-9 (Cont.) Using the CONVERT Routines in a COBOL Program

```
01      OUT-REC.
        02      OUT-NUM      PIC X(4).
        02      OUT-NAME     PIC X(20).
        02      OUT-COLR    PIC X(4).
        02      OUT-WGHT    PIC X(4).
        02      SUPL-NAME   PIC X(20).

WORKING-STORAGE SECTION.
01      MORE-DATA-FLAGS     PIC X(3)      VALUE 'YES'.
        88      THERE-IS-DATA      VALUE 'YES'.
        88      THERE-IS-NO-DATA   VALUE 'NO '.

01      STATVALUE          PIC S9(9)      COMP.

01      OPTIONS            USAGE IS COMP.
        02      NUM-OPTS     PIC S9(9)      VALUE 18.
        02      CREATE      PIC S9(9)      VALUE 1.
        02      NOSHARE     PIC S9(9)      VALUE 0.
        02      FASTLOAD    PIC S9(9)      VALUE 1.
        02      NOMERGE     PIC S9(9)      VALUE 0.
        02      NOPPEND    PIC S9(9)      VALUE 0.
        02      XSORT      PIC S9(9)      VALUE 1.
        02      XWORKFILES  PIC S9(9)      VALUE 2.
        02      KEYS       PIC S9(9)      VALUE 0.
        02      NOPAD      PIC S9(9)      VALUE 0.
        02      PADCHAR    PIC S9(9)      VALUE 0.
        02      NOTRUNCATE  PIC S9(9)      VALUE 0.
        02      NOEXIT     PIC S9(9)      VALUE 0.
        02      NOFIXEDCTRL PIC S9(9)      VALUE 0.
        02      NOFILLBUCKETS PIC S9(9)    VALUE 0.
        02      NOREADCHECK PIC S9(9)      VALUE 0.
        02      NOWRITECHECK PIC S9(9)     VALUE 0.
        02      FDL        PIC S9(9)      VALUE 1.
        02      NOEXCEPTION PIC S9(9)      VALUE 0.

01      STATSBLK          USAGE IS COMP.
        02      NUM-STATS   PIC S9(9)      VALUE 4.
        02      NUM-FILES   PIC S9(9)      VALUE 0.
        02      NUM-RECS    PIC S9(9)      VALUE 0.
        02      NUM-EXCS    PIC S9(9)      VALUE 0.
        02      NUM-VALRECS PIC S9(9)      VALUE 0.

PROCEDURE DIVISION.
MAIN.
    PERFORM CONVERT-FILE THRU DISPLAY-STATS.
    OPEN INPUT IN-FILE.
    READ IN-FILE
        AT END MOVE 'NO ' TO MORE-DATA-FLAGS.
    CLOSE IN-FILE.
    STOP RUN.

CONVERT-FILE.
    CALL 'CONV$PASS_FILES' USING BY DESCRIPTOR 'SEQ.DAT'
                                BY DESCRIPTOR 'CUSTDATA.DAT'
                                BY DESCRIPTOR 'INDEXED.FDL'
                                GIVING STATVALUE.

    IF STATVALUE IS FAILURE
    CALL 'LIB$STOP' USING BY VALUE STATVALUE.

    CALL 'CONV$PASS_OPTIONS' USING BY CONTENT OPTIONS
                                GIVING STATVALUE.

    IF STATVALUE IS FAILURE
    CALL 'LIB$STOP' USING BY VALUE STATVALUE.
```

(continued on next page)

**Example 4–9 (Cont.) Using the CONVERT Routines in a COBOL Program**

```

CALL 'CONV$CONVERT' USING BY REFERENCE STATSBLK
                        GIVING STATVALUE.
IF STATVALUE IS FAILURE
CALL 'LIB$STOP' USING BY VALUE STATVALUE.

DISPLAY-STATS.
  DISPLAY 'Number of files processed:  ',NUM-FILES CONVERSION.
  DISPLAY 'Number of records:         ',NUM-RECS CONVERSION.
  DISPLAY 'Number of exception records:',NUM-EXCS CONVERSION.
  DISPLAY 'Number of valid records:   ',NUM-VALRECS CONVERSION.

```

For more information about calling the Convert routines, see the *OpenVMS Utility Routines Manual*.

## 4.6 Summary of File-Creation Options

This section summarizes the file-creation options that are available using RMS. File-creation options may be available as qualifiers or keywords to the OPEN statement and include various aspects of file creation, including file disposition, file characteristics, file allocation, and file positioning.

Note that the run-time options for opening files in conjunction with creating files are not included here, but they are described in Chapter 9.

### 4.6.1 File-Creation Options

The following table lists the creation-time options that apply to specifying how an application uses a file:

| Name of Option    | Function  |
|-------------------|---|
| Create-if         | <p>Creates the file only if the directory does not contain a file with the same name. If a file with the same name exists in the directory, RMS opens the existing file instead of creating a new file.</p> <ul style="list-style-type: none"> <li>• FDL: FILE CREATE_IF</li> <li>• RMS: FAB\$L_FOP FAB\$V_CIF</li> </ul> |
| Maximize version  | <p>Creates the file with the specified version number or a version number one greater than a file of the same name in that directory.</p> <ul style="list-style-type: none"> <li>• FDL: FILE MAXIMIZE_VERSION</li> <li>• RMS: FAB\$L_FOP FAB\$V_MXV</li> </ul>  |
| Supersede version | <p>Supersedes the file with the same name, type, and version number in the current directory.</p> <ul style="list-style-type: none"> <li>• FDL: FILE SUPERSEDE</li> <li>• RMS: FAB\$L_FOP FAB\$V_SUP</li> </ul>   |

## Creating and Populating Files

### 4.6 Summary of File-Creation Options

| Name of Option    | Function  |
|-------------------|---|
| Temporary         | <p>Creates a temporary file (which has no directory entry) that is retained when the file is closed. The file can be accessed only if its internal file identifier is known (requires the use of a name block). Name blocks provide additional fields for extended file specifications.</p> <ul style="list-style-type: none"> <li>• FDL: FILE DIRECTORY_ENTRY</li> <li>• RMS: FAB\$L_FOP FAB\$V_TMP</li> </ul> |
| Temporary, delete | <p>Creates a temporary file (which has no directory entry) marked for deletion. The file is deleted automatically when the file is closed.</p> <ul style="list-style-type: none"> <li>• FDL: FILE TEMPORARY</li> <li>• RMS: FAB\$L_FOP FAB\$V_TMD</li> </ul>  |

#### 4.6.2 File Characteristics

The creation-time options that define file characteristics are described in the following chart:

| Name of Option    | Function  |
|-------------------|---|
| Block size        | <p>Defines the number of bytes to be used in each block (unit of I/O) throughout the life of this file. This file characteristic applies only to magnetic tape files.</p> <ul style="list-style-type: none"> <li>• FDL: FILE MT_BLOCK_SIZE</li> <li>• RMS: FAB\$W_BLS</li> </ul>                      |
| Bucket size       | <p>Defines the number of blocks to be used in each bucket (unit of I/O) throughout the life of this file. This file characteristic applies only to relative and indexed files.</p> <ul style="list-style-type: none"> <li>• FDL: FILE BUCKET_SIZE</li> <li>• RMS: FAB\$B_BKS or XAB\$B_BKZ</li> </ul> |
| Date information  | <p>Specifies the date and time values for file backup, file creation, file expiration, and file revision. Can also set the number of file revisions.</p> <ul style="list-style-type: none"> <li>• FDL: DATE attributes and FILE REVISION</li> <li>• RMS: Date and Time XAB fields</li> </ul>          |
| File organization | <p>Defines the file organization: sequential, relative, or indexed.</p> <ul style="list-style-type: none"> <li>• FDL: FILE ORGANIZATION</li> <li>• RMS: FAB\$B_ORG</li> </ul>   |

## Creating and Populating Files

### 4.6 Summary of File-Creation Options

| Name of Option                  | Function  |
|---------------------------------|---|
| File protection                 | <p>Defines the file protection for the file being created.</p> <ul style="list-style-type: none"><li>• FDL: FILE OWNER, FILE PROTECTION, FILE MT_PROTECTION</li><li>• RMS: Protection XAB fields</li></ul>  |
| Fixed-length control field size | <p>Defines the number of bytes in the fixed-length control field of a VFC record.</p> <ul style="list-style-type: none"><li>• FDL: FILE CONTROL_FIELD_SIZE</li><li>• RMS: FAB\$B_FSZ</li></ul>  |
| Key characteristics             | <p>Defines the characteristics of a key in an indexed file, including key size, starting position, key type, bucket fill size, and key options.</p> <ul style="list-style-type: none"><li>• FDL: KEY attributes</li><li>• RMS: Key Definition XAB fields</li></ul>  |
| Maximum record number           | <p>Defines the maximum number of records for the file. Applies only to relative files.</p> <ul style="list-style-type: none"><li>• FDL: FILE MAX_RECORD_NUMBER</li><li>• RMS: FAB\$L_MRN</li></ul>  |
| Maximum record size             | <p>Defines the maximum record size for all records in the file. Maximum record size refers to the size of all records in a file with fixed-length records, the size of the largest record with variable-length records, or the size of the variable-length portion of VFC records. A value of 0 with variable-length records means that there is no limit on the record size, except for magnetic tape files, for which a value of 0 sets an effective maximum record size equal to the block size minus 4. Variable-length records and VFC records must conform to certain physical limitations (see the <i>OpenVMS Record Management Services Reference Manual</i>).</p> <ul style="list-style-type: none"><li>• FDL: RECORD SIZE</li><li>• RMS: FAB\$L_MRS</li></ul> |

## Creating and Populating Files

### 4.6 Summary of File-Creation Options

| Name of Option    | Function  |
|-------------------|---|
| Record attributes | <p>Defines the following control information for each record:</p> <ul style="list-style-type: none"> <li>• Records can use one of the following carriage control conventions: <ul style="list-style-type: none"> <li>– Each record is preceded by a line feed and terminated by a carriage return (FDL attribute RECORD CARRIAGE_RETURN). This is the default.</li> <li>– Each record contains a Fortran carriage return (FDL attribute RECORD FORTRAN).</li> <li>– Each record is in print format where the two-byte fixed-length control field (VFC record format) of each record contains the carriage return information (FDL attribute RECORD PRINT).</li> <li>– No carriage control provided (FDL attribute RECORD NONE).</li> </ul> </li> <li>• Records can be prevented from crossing block boundaries (FDL attribute RECORD BLOCK_SPAN).</li> <li>• For variable-length records, the byte count field may be formatted in LSB (least-significant-byte) format (default) or in MSB (most-significant-byte) format (FDL attribute RECORD MSB_RECORD_LENGTH).</li> <li>• FDL: RECORD BLOCK_SPAN, RECORD MSB_RECORD_LENGTH</li> <li>• RMS: FAB\$B_RAT</li> </ul> |
| Record format     | <p>Defines the record format:</p> <ul style="list-style-type: none"> <li>• Fixed-length record format</li> <li>• Variable-length record format</li> <li>• VFC record format</li> <li>• Stream record format</li> <li>• Undefined record format (sequential files only)</li> <li>• FDL: RECORD FORMAT</li> <li>• RMS: FAB\$B_RFM</li> </ul>  |

#### 4.6.3 File Allocation and Positioning

You can specify file-allocation and positioning options with either the FAB control block or an allocation XAB (XABALL) control block. Note that any value specified in the XABALL control block overrides the corresponding value in the FAB. The creation-time options described in the following table apply to file allocation and positioning:

## Creating and Populating Files

### 4.6 Summary of File-Creation Options

| Name of Option      | Function   |
|---------------------|--|
| Allocation quantity | <p>Allocates the file or area using the number of blocks specified by this value, rounded up to the nearest even multiple of the volume's cluster size.</p> <ul style="list-style-type: none"> <li>• FDL: FILE ALLOCATION or AREA ALLOCATION</li> <li>• RMS: FAB\$L_ALQ or XAB\$L_ALQ</li> </ul>   |
| Areas               | <p>Allocates the file using single or multiple areas. Applies only to indexed files; sequential and relative files are always contained in a single area. Indexed files can be placed in specific areas, for example, to separate the data area from the index area.</p> <ul style="list-style-type: none"> <li>• FDL: AREA number</li> <li>• RMS: XAB\$B_AID</li> </ul> |
| Contiguous          | <p>Allocates the file or area using a single extent. If the disk's unallocated space does not permit the file to be allocated contiguously, an error is returned.</p> <ul style="list-style-type: none"> <li>• FDL: FILE CONTIGUOUS or AREA CONTIGUOUS</li> <li>• RMS: FAB\$L_FOP FAB\$V_CTG or XAB\$L_AOP XAB\$V_CTG</li> </ul>   |
| Contiguous best try | <p>Attempts to allocate the file or area using a minimum number of extents. If the file cannot be allocated contiguously, an error is not returned.</p> <ul style="list-style-type: none"> <li>• FDL: FILE BEST_TRY_CONTIGUOUS or AREA BEST_TRY_CONTIGUOUS</li> <li>• RMS: FAB\$L_FOP FAB\$V_CBT or XAB\$L_AOP XAB\$V_CBT</li> </ul>                                     |
| Cylinder boundary   | <p>Allocates the file or area at the beginning of a cylinder boundary.</p> <ul style="list-style-type: none"> <li>• FDL: AREA POSITION ANY_CYLINDER</li> <li>• RMS: XAB\$B_AOP XAB\$V_ONC</li> </ul>   |
| Cylinder position   | <p>Positions the file or area at the beginning of the specified cylinder number.</p> <ul style="list-style-type: none"> <li>• FDL: AREA POSITION CYLINDER</li> <li>• RMS: XAB\$B_ALN XAB\$V_CYL and XAB\$L_LOC</li> </ul>  |

## Creating and Populating Files

### 4.6 Summary of File-Creation Options

| Name of Option         | Function  |
|------------------------|---|
| Default extension      | <p>Defines the minimum number of blocks for a file extension (extent) when additional disk space is needed. For the Edit/FDL utility file extension sizes, see Appendix A.</p> <ul style="list-style-type: none"> <li>• FDL: FILE EXTENSION</li> <li>• RMS: FAB\$W_DEQ or XAB\$W_DEQ</li> </ul>                               |
| Hard positioning       | <p>Directs OpenVMS RMS to return an error if the requested file or area positioning or alignment cannot be performed.</p> <ul style="list-style-type: none"> <li>• FDL: AREA EXACT_POSITIONING</li> <li>• RMS: XAB\$B_AOP XAB\$V_HRD</li> </ul>   |
| Logical block position | <p>Positions the file or area at the beginning of the specified logical block.</p> <ul style="list-style-type: none"> <li>• FDL: AREA POSITION LOGICAL</li> <li>• RMS: XAB\$B_ALN XAB\$V_LBN and XAB\$L_LOC</li> </ul>  |
| Related file position  | <p>Positions the file or area as close as possible to a related file, at the specified virtual block.</p> <ul style="list-style-type: none"> <li>• FDL: AREA POSITION FILE_ID or AREA POSITON FILE_NAME</li> <li>• RMS: XAB\$B_ALN XAB\$V_RFI and XAB\$L_LOC</li> </ul>   |
| Virtual block position | <p>Positions the file or area at the beginning of the specified virtual block.</p> <ul style="list-style-type: none"> <li>• FDL: AREA POSITION VIRTUAL</li> <li>• RMS: XAB\$B_ALN XAB\$V_VBN and XAB\$L_LOC</li> </ul>  |
| Truncate end of file   | <p>Truncates a nonshared sequential file at its logical end to release the space between the logical end of the file (end of file data) and the physical end of the file (allocated file space) for other use.</p> <ul style="list-style-type: none"> <li>• FDL: FILE_TRUNCATE_ON_CLOSE</li> <li>• RMS: FAB\$V_TEF</li> </ul> |
| Volume number          | <p>Indicates the volume set where the file or area is placed when it is created.</p> <ul style="list-style-type: none"> <li>• FDL: AREA VOLUME</li> <li>• RMS: XAB\$W_VOL</li> </ul>  |

For the list of the run-time options that are common to creating and opening a file, see Chapter 9.

## Creating and Populating Files

### 4.6 Summary of File-Creation Options

For more information about the options listed above, see Chapter 2. For more detailed information about the programming aspects of these options, refer to the *OpenVMS Record Management Services Reference Manual*.



---

## Locating and Naming Files on Disks

When creating or opening a file, your program must identify it with an appropriate file specification. Typically, high-level languages require a file specification argument for an OPEN statement that names a file being created or locates a file being opened.

The most direct way for an application to provide a file specification is to accept a complete specification from the user and to pass it to the OPEN statement.

Another way is to have the application program supply specifications to RMS so that RMS can combine these, as defaults, with a partial user specification to compose a fully qualified file specification. Or, to have RMS resolve a partial specification by searching the disk for an existing file that matches the specification.

This chapter describes the components that make up a complete file specification and how RMS is used to name and locate files on disks. Chapter 6 describes in more detail the process that RMS uses to compose fully qualified file specifications from user input and from application input.

---

### Note

---

This chapter documents file specifications as presented at the RMS interface such as RMS services SYS\$OPEN and SYS\$SEARCH. For details on specifications at the ACP-XQP interface, such as the system service SYS\$QIO, refer to the *OpenVMS I/O User's Reference Manual*.

As of OpenVMS V7.2, RMS on Alpha systems has been extended to support disk file specifications of greater length and with a larger character set than was supported on prior versions and than is supported on VAX platforms. Some of the extended features can be used on existing ODS-2 structure-level disks. Many features are available only on ODS-5 structure-level disks. Throughout this chapter, behaviors that differ depending upon the architecture, Alpha or VAX, or upon the target device, ODS-5 disk or ODS-2 disk, are so marked in the text.

---

## 5.1 Understanding Disk File Specifications

A disk file specification on an OpenVMS system consists of up to seven components, several of which assume default values when they are not specified. To allow RMS to identify the boundaries of each component, certain characters separate the components in a file specification. These characters mark the beginning or the end of a file specification component and allow RMS to identify missing components for which defaults can be substituted. A complete file specification takes the following form:

```
node::device:[root.][directory-name]filename.type;version
```

## Locating and Naming Files on Disks

### 5.1 Understanding Disk File Specifications

The following table lists the characters that separate components of a file specification:

| Component    | Separator Character(s)  |
|--------------|---|
| Node         | Double colon (::) ends a node name.   |
| Device       | Single colon (:) ends a device name.  |
| Root         | Square brackets ([]) or angle brackets (<>) delimit the root name. Within the root component, a period (.) separates subdirectory names. A period (.) before the closing bracket distinguishes a root component from a directory. |
| Directory    | Square brackets ([]) or angle brackets (<>) delimit the directory name. Within the directory component, a period (.) separates subdirectory names.  |
| File Name    | The rightmost period (.) that is not the version delimiter begins the type component and ends the file name.  |
| File Type    | The rightmost period (.) that is not the version delimiter begins the type component. A version delimiter ends the type component.  |
| File Version | Period (.) or semicolon (;) followed by legal version characters begins the version. Section 5.2.7 describes a legal version component. The end of the file specification ends the file version.                                  |

Some examples of valid file specifications follow:

```
DISK1:[MYROOT.] [MYDIR]FILE.DAT
DISK1:[MYDIR]FILE.DAT
[MYDIR]FILE.DAT
FILE.DAT;10
NODE::DISK5:[REMOTE.ACCESS]FILE.DAT
```

## 5.2 File Specification Components

The following sections describe the particular file specification components.

### 5.2.1 The Node Component

Whether or not you should include the optional node component in a file specification depends on whether you confine file activity to the local node, or you conduct file activity on remote nodes. To locate a file on the local node, or in an OpenVMS Cluster environment, you do not have to include the node name in the file specification.

---

#### Note

---

In this chapter, discussions that refer to OpenVMS Cluster environments apply to both VAXcluster systems that include only VAX nodes and OpenVMS Cluster systems that include at least one Alpha node unless indicated otherwise.

---

Conversely, to locate a file on a remote node, you must present the name of the remote node either as the physical node name or as a logical name whose translation contains the physical node name. A logical node name can also contain access control information used to log in to the remote system.

### 5.2.1.1 Local Node

The following file specification format does not include a node name:

```
device:[root.][directory-name]filename.type;version
```

This is the general format of a file specification used to locate a file on the local node, or in an OpenVMS Cluster.

Note that a null node name of the form “:” specifies the local node; this form overrides any default node names.

### 5.2.1.2 Remote Node

The following file specification formats are used for accessing files on remote nodes:

```
node::filespec
```

```
node“access-control-string”::filespec
```

The second file specification format includes an access control string. If an access control string is specified or if the process seeking to gain access to a remote file has a proxy login account on the remote node, the specified remote process uses its access rights to locate the file. If an access control string is not specified and a proxy account does not exist on the remote system, the local process may use the default DECnet account, if there is one, to locate the file.

The following file specification format, known as a foreign file specification, is used to locate files on remote nodes that might have file specification formats that differ from those of the local node:

```
node::“foreign-filespec”
```

The only action RMS takes with the foreign file specification is to translate the logical node name, if applicable. This format is especially useful when the remote system is not an OpenVMS system and the file specification does not conform to OpenVMS file specification syntax conventions. Refer to the *DECnet for OpenVMS Networking Manual* for more information.

The following file specification format does not specify a file directly. Instead, it specifies a task on the remote system.

```
node::“task-spec-string”
```

For more information about specifying a logical node name or using any of the file specification formats and their associated syntax rules, refer to the *OpenVMS User's Manual*.

## 5.2.2 The Device Component

The device can be identified with either a physical name or a logical name. You can terminate a physical device name or a logical device name with a colon and place one or more file specification components (directory name, file name, file type, and version) after it.

A logical device name may translate to another logical name, a physical device name, or a physical device name with additional file specification components. The logical name may translate to a combined device name, which may be a logical name itself, and root name. The logical name can be a search list, which specifies multiple file locations where the file can be found. (See Section 5.7.)

## Locating and Naming Files on Disks

### 5.2 File Specification Components

You have to include only the device name when specifying a record-oriented device, such as a terminal. However, if you choose to include other file specification components, you must follow the naming conventions described previously.

See also section Section 5.3.

The following file specification format is used only for ANSI-formatted magnetic tape volumes:

device:[directory-name]"quoted-ascii-a-string".;nn

The *OpenVMS User's Manual* lists the characters from the DEC Multinational character set and the ASCII "a" characters that can be used in a quoted string for naming ANSI-formatted magnetic tape files.

#### 5.2.3 On-Disk Components

The following sections describe the file specification components that apply to files residing on disks. The details of the components are determined by whether the application is running on an Alpha system or a VAX system and on the structure level of the disk.

##### 5.2.3.1 Character Set for On-Disk Components

As of OpenVMS V7.2 on Alpha systems, RMS supports a larger character set than was supported in previous versions; it is also larger than the set that is supported under V7.2 on VAX systems. Creating such files is supported only on disks of ODS-5 (or greater) structure level.

**5.2.3.1.1 Base Character Set** On OpenVMS Alpha and VAX systems, on ODS-5 and ODS-2 devices, a basic set of **simple characters** is valid for the node, device, root, directory, and file name and type components of a file specification. These characters include the following:

- Upper and lowercase alphanumeric characters:

A - Z, a - z, 0 - 9

- Special ASCII (7-bit) characters:

\$ - \_ ~

**5.2.3.1.2 Extended Character Set** In addition, OpenVMS V7.2 on Alpha systems and ODS-5 disks includes support for the use of file names, and subdirectory and root subdirectory names, that include all possible 8-bit characters, excluding values 00 through 1F (hexadecimal) and excluding the following characters:

< > : / \ | ? \* "

OpenVMS 7.3-1 on Alpha systems and ODS-5 disks includes enhanced support for the use of file names, and subdirectory and root subdirectory names. It supports all possible 8-bit characters, excluding only the following two characters:  
? \*

Note that the character set includes both the ISO Latin-1 C1 character set (hexadecimal 80 - 9F) as well as graphical and other characters between 9F and FF. This allows the entire ISO Latin-1 character set (with the exclusions noted above). In addition, there is support for names that include any of the defined 16-bit Unicode characters (except for the character exclusions noted above).

### 5.2.4 RMS and On-Disk Representation

The extended character set includes characters that have special significance to RMS (for example, delimiters, such as ')'), that have significance to DCL (for example, the comment character, '!'), and that cannot be easily entered or displayed via keyboards and display devices that are commonly available (for example, the Unicode characters and the ISO Latin-1 C1 control characters). To accommodate the use of these characters, RMS accepts and displays them in a format that uses a sequence of common ASCII characters to represent a single one of these special characters. These sequences are known as **compound characters**. For example, the sequence of six simple characters "^U1234" comprise a compound character to represent the Unicode character that corresponds to the hexadecimal value 1234. Likewise, the compound character "^[" is used to include the bracket as a character in a file or directory name rather than as the root or directory component delimiter. And, the compound character "^." is used to represent the period as a character in a file or directory name rather than as the file type or the subdirectory delimiter.

The **RMS escape character** (^) is always used to begin one of these compound characters.

Certain characters can be represented in more than one way as input to RMS. Each character, however, will always be represented the same way in RMS's output, no matter which representation was used for input. The standard representation for each character is known as its **canonical form**.

For example, the input specifications:

File^37.Txt    and    File^U0037.Txt

would appear in output as:

File7.Txt

(The ASCII encoding of the numeral '7' is the hexadecimal value 37.)

---

**Note**

---

The use of compound characters in RMS is allowed only on Alpha systems running OpenVMS Version 7.2. The use of ODS-5 characters that are not also ODS-2 characters is allowed only on ODS-5 disks accessed from Alpha systems running OpenVMS Version 7.2.

---

When RMS outputs a file specification (as a resultant name, for example), it follows the rule that other ISO Latin-1 8-bit characters that have no graphical representation or which are used for control functions by other OpenVMS software or by terminals is represented by an escape character followed by two hexadecimal digits (^xx). Otherwise, it is represented by its own character. The following 8-bit values are output as an escape character followed by two hexadecimal digits.

7F (rubout)  
80-9F (C1 control characters)  
A0 (nonbreaking space)  
A0 (nonbreaking space)  
FF (Latin small letter y diaeresis)

## Locating and Naming Files on Disks

### 5.2 File Specification Components

#### 5.2.4.1 Simple Characters

The set of characters valid through the RMS interface in a file specification (without any special escape character) includes the following. Note that these characters must not be preceded by the escape character ^.

- Upper and lowercase alphanumeric characters:

A - Z  
a - z  
0 - 9

- Special ASCII (7-bit) characters:

Dollar sign (\$)  
Minus sign (-)  
Underscore (\_)

- ISO Latin-1 (graphic) characters in the range (hexadecimal) A0 to FF.

#### 5.2.4.2 Compound Characters

Escape followed by a pair of hexadecimal digits is interpreted as a hexadecimal value for an arbitrary (and otherwise legal) 1-byte character.

For example, ^20 represents a space. (The ASCII code for space is hexadecimal 20.)

Escape followed by "\_" or by a space represents a space.

Escape followed by "U" followed by 4 hexadecimal digits is interpreted as a 2-byte Unicode character.

Escape followed by any of the following characters means that the character is to be used as part of a file name rather than as a character that has a special meaning in a file specification. For the period (.)<sup>1</sup> and tilde (~)<sup>2</sup>, the escape character is required only under some circumstances, detailed in their respective footnotes.

Period (.)<sup>1</sup>  
Comma (,)  
Semilcolon (;)  
Left bracket ([)  
Right bracket (])  
Percent (%)  
Circumflex (^)  
Amperesand (&)  
Exclamation point (!)  
Pound sign (#)  
Apostrophe (')  
Left parenthesis ((  
Right parenthesis ())  
Plus sign (+)  
Atsign (@)  
Grave accent (`)  
Left brace ({)  
Right brace (})  
Equal sign (=)  
Tilde (~)<sup>2</sup>

<sup>1</sup> The escape character is required before a period in a directory name, is optional before a period in a file name, and must not be used for the period that delimits the file type. A period is not permitted in a file type.

<sup>2</sup> The tilde that is the leading character in a file name or directory may require an escape character.

## Locating and Naming Files on Disks

### 5.2 File Specification Components

The following characters may be preceded by an escape, but need not be on input to RMS.

Period (.)<sup>1</sup>  
Dollar sign (\$)  
Minus sign (-)  
Tilde (~)<sup>2</sup>

Sequences consisting of the escape character followed by any character not mentioned previously are reserved.

Spaces not preceded by the RMS escape character are removed from the specification by RMS (on Alpha and VAX).

Note that the extended character set applies only to directory names and file names. Device names and node names must conform to ODS-2 requirements.

#### 5.2.4.3 Uppercase and Lowercase Letters and Multiple File Versions

On ODS-5 disks on Alpha systems, the Extended File Specifications changes added support in OpenVMS Version 7.2 for preserving case (as in uppercase and lowercase letters). If a file is created with lowercase letters from program control, the name, as stored on disk, is lowercase.

From the DCL command interface, file names that are entered at the command prompt with lowercase letters will be translated by default to uppercase before they are passed to RMS. Case may be preserved from the DCL command interface by using the DCL command SET PROCESS/PARSE\_STYLE=EXTENDED (also see the SYS\$SET\_PROCESS\_PROPERTIESW system service).

File look-ups, however, are case-blind. For example, the filename "File.Txt" (as stored on an ODS-5 disk) could be accessed with a reference to "FILE.TXT" or "file.txt".

As of OpenVMS Version 7.3-1, an option may be set for file look-ups at either the process or file level to request RMS to either ignore or notice the case sensitivity of file names on ODS-5 disks.

At the process level, the user may request RMS to ignore case by using SET PROCESS/CASE\_LOOKUP=BLIND. If a file on an ODS-5 disk already exists whose name matches that of a file being created except for its case, the new file will be created with the same case as the existing file (rather than with the case as entered). This is the default behavior. In contrast, the user may request RMS to notice case by using SET PROCESS/CASE\_LOOKUP=SENSITIVE (also see the SYS\$SET\_PROCESS\_PROPERTIESW system service). If the SENSITIVE option is in effect and the user creates more than one file on an ODS-5 disk with the same name differing only in case, each file is treated as a new file.

At the file level, the NAML\$V\_CASE\_LOOKUP flag can be used to instruct RMS to ignore or notice case for a file on an ODS-5 disk (see the NAM\$L\_INPUT\_FLAGS field in the NAML structure in the *OpenVMS Record Management Services Reference Manual*). NAML\$C\_CASE\_BLIND is set to tell RMS to ignore case or NAML\$C\_CASE\_LOOKUP\_SENSITIVE to notice case when creating, deleting or searching for a file on an ODS-5 disk. If the NAML structure is not used or this flag is zero, the current process setting for CASE\_LOOKUP is used.

The SET PROCESS/PARSE\_STYLE qualifier is independent of the /CASE\_LOOKUP qualifier. If the creation, deletion, or search of files on an ODS-5 disk is being done using the DCL command interface and case is relevant, /PARSE\_STYLE=EXTENDED must be used to inform the DCL interface to preserve the

## Locating and Naming Files on Disks

### 5.2 File Specification Components

case specified in the DCL command. The /CASE\_LOOKUP qualifier instructs RMS whether to ignore or notice the case (either preserved or not).

#### 5.2.4.4 Convert System Service

On Alpha systems, a system service, SYS\$CVT\_FILENAME, is available to convert names between their RMS-interface form and their ACP-XQP on-disk form. See the *OpenVMS System Services Reference Manual: A-GETUAI* for details on its use.

#### 5.2.5 The Root Component

The root component of a file specification begins with an open square bracket ("[") or an open angle bracket ("<") and ends with a period (".") followed by a closing square bracket ("]") or a closing angle bracket (">"). A root that begins with a square bracket must end with a square bracket, and a root that begins with an angle bracket must end with an angle bracket.

The root component contains a series of root subdirectory names, separated by periods.

Examples of legal root components are:

```
[RLEVEL0.]
[RLEVEL0.RLEVEL1.]
[RLEVEL0.RLEVEL1.RLEVEL2.]
<RLEVEL0.RLEVEL1.>
```

---

#### Note

---

An alternate form of root subdirectory name, supported by RMS only on Alpha systems (on both ODS-5 and ODS-2 disks), is that of a directory ID (referred to as "DID"). This form is described in Chapter 6.

---

A root subdirectory name may contain a period ("."). To be distinguishable from the delimiter periods, it must be specified to RMS as "^".

#### 5.2.6 The Directory Component

The directory component of a file specification begins with an open square bracket ("[") or an open angle bracket ("<") and ends with a closing square bracket ("]") or a closing angle bracket (">"). A directory component that begins with a square bracket must end with a square bracket, and a directory component that begins with an angle bracket must end with an angle bracket.

The directory component contains a series of subdirectory names, separated by periods.

Examples of legal directory components are:

```
[DLEVEL0]
[DLEVEL0.DLEVEL1]
[DLEVEL0.DLEVEL1.DLEVEL2]
<DLEVEL0.DLEVEL1>
```

---

#### Note

---

An alternate form of subdirectory name, supported by RMS only on Alpha systems (on both ODS-5 and ODS-2 disks), is that of a directory ID (referred to as "DID"). This form is described in Chapter 6.

---

A subdirectory name may contain a period ("."). To be distinguishable from the delimiter periods, it must be specified to RMS as "^."

### 5.2.7 The File Name, Type, and Version Components

On Alpha systems, RMS identifies the file name, file type, and file version components from the portion of a file specification that follows any node, device, root and directory components as follows:

The right-most semicolon or period followed by legal version characters begins the version component. A semicolon (unescaped) followed by characters that are not legal for a version component is illegal. The right-most period to the left of the version (if any) begins the type component. The characters to the left of the type are the file name.

Legal forms of a version component are:

```
;<decimal digit(s)>
;-<decimal digit(s)>
;* (multiple-character wildcard)
```

On ODS-2 and ODS-5 disks, the numerals in a version component, interpreted as a decimal number, may not exceed 32767.

Note that, although RMS accepts a period as a version delimiter, in output specifications, RMS always uses the semicolon as the delimiter.

The following are some examples of name, type, and version:

| Name+Type+Version | Name | Type      | Version |
|-------------------|------|-----------|---------|
| A.B;1             | A    | .B        | ;1      |
| A.B.C             | A.B  | .C        | (none)  |
| A.B;C             |      | (illegal) |         |
| A.B.1             | A    | .B        | .1      |
| A.B.-1            | A    | .B        | .-1     |
| A.B.-32767        | A    | .B        | .-32767 |
| A^.B              | A^.B | (none)    | (none)  |
| A.B^.C            |      | (illegal) |         |
| A.B;1234567       |      | (illegal) |         |

Note that, although RMS on Alpha systems allows periods in a file name, files with such names can be created only on ODS-5 disks.

---

**Note**

---

An alternate way of specifying a file within a directory, supported by RMS only on Alpha systems (on both ODS-5 and ODS-2 disks), is that of a file ID (referred to as "FID"). This form is described in Chapter 6.

---

On VAX systems and on Alpha systems with versions previous to OpenVMS V7.2, RMS identifies the file name, file type, and file version components from the portion of a file specification that follows any node, device, root, and directory components as follows:

- A semicolon or the right-most period followed by legal version characters begins the version component.
- A semicolon followed by characters that are not legal for a version is illegal.
- A period to the left of the version (if any) begins the type component.

## Locating and Naming Files on Disks

### 5.2 File Specification Components

- No periods, other than the type and version delimiters, are allowed.

#### 5.2.8 Leading Hyphens in File and Subdirectory Names (Alpha Only)

On Alpha systems, OpenVMS Version 7.2 supports the use of file names and subdirectory names that begin with hyphens. This is supported on ODS-5 and ODS-2 disks.

No special action is required for specifying a name that begins with a hyphen, with the following exception. A reference to a subdirectory whose name consists only of hyphens must include at least one escaped hyphen (so that RMS can distinguish the reference from a relative directory specification). On output, RMS always displays such a subdirectory name with the first hyphen escaped.

For example:

```
$CREATE/DIRECTORY DISK$:[^---]
$CREATE/DIRECTORY DISK$:[FLARKY.LEVEL1.LEVEL2.LEVEL3]
$SET DEFAULT DISK$:[FLARKY.LEVEL1.LEVEL2.LEVEL3]
$WRITE SYS$OUTPUT F$PARSE("[^---]")           ! (relative spec.)
DISK$:[FLARKY].;
$WRITE SYS$OUTPUT F$PARSE("[^---]")           ! (directory ---)
DISK$:[^---].;
$$ WRITE SYS$OUTPUT F$PARSE("[-^---]")       ! (directory ---)
DISK$:[^---].;
$DIRECTORY/NOHEADING/NOTRAILING DISK$:[000000]---.DIR
DISK$:[000000]---.DIR;l                       ! (file ---.DIR)
```

---

#### Note

---

OpenVMS Version 7.2 for VAX and versions of OpenVMS prior to Version 7.2 do not support file and subdirectory names with leading hyphens. Although you can create files with such names, it is not recommended because access to the files will be limited to a subset of otherwise-supported functions.

In addition, remember that in a mixed-cluster environment, although such files can be created and accessed from a Version 7.2 Alpha cluster member, they are not fully accessible from all of the other cluster members.

---

#### 5.2.9 Restrictions and Anomalies

The following sections describe a restriction when using extended file names and a DCL parsing anomaly.

##### 5.2.9.1 Restriction with Extended File Names

Using the tilde (~) as the first character in a file name in the Compaq C Run-Time Library (CRTL) allows a programmer to specify both UNIX style and OpenVMS style file specifications to routines such as `creat()` and `fopen()`.

In UNIX file specifications, a tilde (~) in the first character of a pathname represents the user's home directory. However, in an OpenVMS extended file name, a tilde is legal anywhere in a file name or directory name.

To preserve backward compatibility, the CRTL will continue to interpret a leading tilde (~) to mean the user's home directory. To pass an OpenVMS file name that begins with a tilde (~) to a CRTL routine that accepts UNIX style file specifications, specify the tilde preceded by the escape character (^). For example, ^~.

## Locating and Naming Files on Disks

### 5.2 File Specification Components

The following Compaq CRTL functions accept OpenVMS extended file names and require this syntax for a leading tilde (~) in the file specification:

```
.create
.fopen
.freopen
.open
.stat
```

#### 5.2.9.2 DCL Parsing Anomaly

Prior to OpenVMS Version 7.2, DCL parses some file specifications incompletely, and does not detect all illegal ODS-2 file specifications. Specifically, if a file specification has three components separated by two delimiters, DCL does not verify that the second delimiter is a semicolon and the third component is a version number. However, RMS verifies the file specification completely and detects errors that DCL may miss. For example, on an ODS-2 volume:

```
$CREATE A.B.C
%CREATE-E-OPENOUT, error opening A.B. C as output
-RMS-F-SYN, file specification syntax error.
```

For compatibility, this behavior has been preserved. However, this can produce unexpected results when accessing an ODS-5 volume under the following conditions:

- The parsing style is traditional (the default).
- The file specification is illegal on ODS-2.
- DCL does not detect the error.
- The file specification is legal on ODS-5.

Under these conditions, the command CREATE A.B.C succeeds on an ODS-5 volume. However, you cannot access the file with a DCL command that requires a version number (such as the DELETE command). For example:

```
$DELETE A.B.C
%DELETE-E-DELVER, explicit version number or wild card required
$DELETE A.B.C;1
%DCL-W-PARMDEL, invalid parameter delimiter - check use of
special characters \;1\
```

The only way to delete this file when the parsing style is TRADITIONAL is to use wildcards, and for safety, you should use the /CONFIRM qualifier with the DELETE command. However, it is safer to change the parsing style to EXTENDED. For example:

```
$SET PROCESS/PARSE_STYLE=EXTENDED
$DELETE A.B.C;1
$SET PROCESS/PARSE_STYLE=TRADITIONAL
```

## 5.3 Logical Names and Parsing

RMS translates a logical name present in a file specification at run time. The use of logical names can be desirable for several reasons, including program simplification, device independence, file independence, and ease of use.

You can specify the file specification at compile (or assembly) time, or the program can prompt for it at run time. By specifying a logical name when you compile a program, you eliminate having to program a terminal input request, and you preserve the flexibility of being able to specify the input file at run time.

## Locating and Naming Files on Disks

### 5.3 Logical Names and Parsing

Device independence is more readily attainable if a logical name is used for the device name component. By using a logical name rather than explicitly specifying a physical device, an alternate device (usually containing a recent backup copy of the device) can be substituted by changing the definition of the logical name. Typically, device independence can reduce or eliminate the downtime caused by media failure or scheduled preventive maintenance.

Similarly, when you use a logical name, and the current copy of a file is not available, an alternate file can be used. To locate several files in a defined search order, you can use a search list, which is a form of logical name. Alternatively, you can use wildcard characters to locate several files using one file specification; however, wildcard characters do not allow you to specify a search order.

Using a logical name to represent a complex file specification or a file specification component reduces keystrokes to save time and reduces the chance of error. For example, you could define a logical node name that translates to an actual node name and access control string for use when locating remote files. To keep the password a secret when you use this technique, the logical name should be defined interactively rather than in a command procedure.

RMS attempts to treat the file name component as a logical name if the file name is the only component in the file specification. Refer to the *OpenVMS User's Manual* for additional information on defining logical names. No logical name translation is done on any logical name that contains a compound character (containing the RMS escape character: "^").

### 5.4 File Specification and Component Length Limits

The following section describes a file specification on ODS-2 and ODS-5 disks.

#### 5.4.1 VAX Systems and ODS-2 Disks on Alpha Systems

The maximum length of a file specification string is 255 characters, including all separator characters. The following table lists the length limits for each of the component parts of a file specification. Note that although the collective limit exceeds 255 characters, the overriding limitation is on the length of the file specification.

| Component | Number of Characters   |
|-----------|--|
| Node      | Up to 59 bytes including an access control string (physical node names are up to 6 bytes; logical node names are up to 15 bytes) |
| Device    | Up to 15 bytes for a physical device name; up to 64 bytes for a logical device name  |
| Root      | Up to 39 bytes for each root name  |
| Directory | Up to 39 bytes for each subdirectory and subdirectory name   |
| Filename  | Up to 39 bytes   |
| Type      | Up to 39 bytes   |
| Version   | Up to 5 digits, which optionally may be preceded by a hyphen (-)   |

## Locating and Naming Files on Disks

### 5.4 File Specification and Component Length Limits

#### 5.4.2 ODS-5 on Alpha Systems

The maximum length of a file specification string is 4095 characters, including all delimiters. The following table lists the length limits for each of the component parts of a file specification.

| Component | Number of Characters   |
|-----------|--|
| Node      | Up to 59 bytes including an access control string (physical node names are up to 6 bytes; logical node names are up to 15 bytes)   |
| Device    | Up to 15 bytes for a physical device name; up to 64 bytes for a logical device name  |
| Root      | The sum of all of the characters in all of the subdirectory names (not counting the brackets or the delimiter periods) should not exceed 512 (compound) characters. In addition, individual subdirectory names have the same constraints as those for the file name, type, and version components, taking into account the fact that subdirectories are stored on disk in the form of files with the names <subdirectory>.DIR;1. |
| Directory | The sum of all of the characters in all of the subdirectory names (not counting the brackets or the delimiter periods) should not exceed 512 (compound) characters. In addition, individual subdirectory names have the same constraints as those for the file name, type, and version components, taking into account the fact that subdirectories are stored on disk in the form of files with the names <subdirectory>.DIR;1. |
| File Name | Up to 255 bytes, subject to the constraint on the sum of the lengths of the file name, the file type, and the file version, as described below.  |
| Type      | Up to 255 bytes, subject to the constraint on the sum of the lengths of the file name, the file type, and the file version, as described below.  |
| Version   | Up to 5 digits, which optionally may be preceded by a hyphen (-) (plus the delimiter), subject to the constraint on the sum of the lengths of the file name, the file type, and the file version, as described below.  |

RMS supports file names for which the sum of the lengths of the file name, the file type, and the file version does not exceed 255 (simple) characters. ODS-5 disks support file names for which the sum of the lengths of the file name and the file type does not exceed 236 bytes.

Be careful when naming files that will be copied or accessed by remote systems. File name restrictions are generally determined by the file naming capabilities of the networked systems that require access to them. These restrictions must be considered part of the overall application design when network access is required.

#### 5.4.3 Maximum Subdirectory Depths

RMS supports creating and accessing up to 255 subdirectory levels (in any combination in the root and directory components) on ODS-2 and ODS-5 volumes accessed from Alpha systems. For ODS-2 and ODS-5 volumes accessed from VAX systems, RMS supports up to 8 subdirectory levels each for the root and directory components.

## Locating and Naming Files on Disks

### 5.4 File Specification and Component Length Limits

#### 5.4.4 Accessing Files on ODS-5 Disks from VAX Systems

On VAX systems, RMS allows access to ODS-5 volumes. But, file specifications are allowed on those volumes that RMS on VAX does not support. Some of the limitations are described here.

When a search is done of a directory that contains files whose names are legal for ODS-5, but not for ODS-2, one of two pseudonames, "\PISO\_LATIN\???" or "\PUNICODE\???" will be displayed. Such files can be accessed via RMS only from an Alpha system.

It is possible to create directory trees on both ODS-5 and ODS-2 volumes that are deeper than RMS can display. In those cases, RMS will not display any subdirectories that lie beyond its limits.

#### 5.4.5 Determining the Structure Level of a Disk Device

From DCL, you can determine a disk device's structure level (for example, ODS-2 or ODS-5) via a SHOW DEVICE/FULL command.

A DCL command procedure can determine the structure level with code such as the following:

```
$!  
$DeviceName = "SYS$SYSDEVICE"  
$DeviceType = F$GETDVI(DeviceName,"ACPTYPE")  
$IF DeviceType .EQS. "F11V5"  
$THEN  
$   DeviceType = "ODS-5"  
$ELSE IF DeviceType .EQS. "F11V2"  
$   THEN  
$     DeviceType = "ODS-2"  
$   ELSE  
$     DeviceType is "unknown"  
$ENDIF  
$ENDIF  
$WRITE SYS$OUTPUT -  
$   "Disk ''DeviceName' on-disk structure is ''DeviceType'"  
$!  
$EXIT
```

The structure level can be determined in a program (executable image) via a call to the SYS\$GETDVI system service using an item list with the DVI\$\_ACPTYPE request code. The following example, in the C programming language, displays a disk device's structure level of determining ODS-2 against ODS-5.

## Locating and Naming Files on Disks

### 5.4 File Specification and Component Length Limits

```
//;
//; Copyright 2001 Compaq Computer Corporation
//;
//; Compaq and the Compaq logo Registered in U.S. Patent and Trademark Office.
//;
//; Confidential computer software. Valid license from Compaq required for
//; possession, use or copying. Consistent with FAR 12.211 and 12.212,
//; Commercial Computer Software, Computer Software Documentation, and
//; Technical Data for Commercial Items are licensed to the U.S. Government
//; under vendors standard commercial license.
//;
//; Module:
//; Determine_ODS_Level.C
//;
//; Abstract:
//; Main (sole) module for a program to display the
//; the on-disk structure level (e.g., ODS-2, ODS-5...)
//; of a disk device, based on the ACP type identified
//; by the SYS$GETDVI system service.
//;
//; The device is identified by name, via the string
//; deviceName, specified below.
//;
//;
//; To Build (OpenVMS/Alpha):
//; CC Determine_ODS_Level [/NODEBUG/OPTIMIZE]
//; LINK Determine_ODS_Level [/NODEBUG]
//; RUN Determine_ODS_Level [/NODEBUG]
//;

// Include (Header) Files
//
#include <descrip.h> // VMS descriptors...
#include <dvidf.h> // SYS$GETDVI() arguments
#include <lib$routines.h> // lib$signal()...
#define _NEW_STARLET 1 // for built-in IOSB defn.
#include <starlet.h> // sys$getdvi()...
#include <iosbdef.h> // struct iosb
#include <stdio.h> // printf()...
#include <string.h> // strlen()...

// Structure Definitions
//
#pragma member_alignment save
#pragma nomember_alignment // structure members must be adjacent
typedef struct _item_list_3 // sys$getdvi() item list (one entry)
{
    unsigned short bufflen;
    unsigned short itemcode;
    unsigned long *buffaddr;
    signed long *retlenaddr;
    unsigned int terminator;
} ITEM_LIST_3;
#pragma member_alignment restore
```

## Locating and Naming Files on Disks

### 5.4 File Specification and Component Length Limits

```
// Main routine.
//
main()
{
    static struct dsc$descriptor DevNameDesc; // descriptor for device name buffer references
    char deviceName[]="SYS$SYSDEVICE"; // device name string
    unsigned long ACP_typeBuffer; // buffer for returned ACP type info. from sys$getdvi()
    long retLen; // buffer for returned info. length (4) from sys$getdvi()
    int status; // SYS$GETDVI() return status
    struct iosb iosb; // I/O status block for SYS$GETDVI
    ITEM_LIST_3 DVI_itemList; // item list for sys$getdvi()

    // Initialize the descriptor for the device name string.
    //
    DevNameDesc.dsc$w_length = strlen(deviceName);
    DevNameDesc.dsc$a_pointer = &deviceName[0];

    // Initialize the item list to request ACP type information
    // from sys$getdvi().
    //
    DVI_itemList.bufflen = sizeof(ACP_typeBuffer);
    DVI_itemList.itemcode = DVI$ACPTYPE;
    DVI_itemList.buffaddr = &ACP_typeBuffer;
    DVI_itemList.retlenaddr = &retLen;
    DVI_itemList.terminator = 0;

    status = sys$getdviw(0, // efn (not used)
                        0, // channel (not used)
                        &DevNameDesc, // device name (descriptor, by ref.)
                        &DVI_itemList, // item list (by ref.)
                        &iosb, // I/O status block (by ref.)
                        0, // astadr (not used)
                        0, // astprm (not used)
                        0); // nullarg (not used)

    if ((status & 1) == 1) status = iosb.iosb$w_status; // If the call succeeded, get the
                                                    // status value from the queued request.
    if (status & 1) // If success...
    {
        switch(ACP_typeBuffer)
        {
            case DVI$C ACP F11V1:
                printf("On-disk structure level of disk device %s is 1\n",
                    deviceName);
                break;
            case DVI$C ACP F11V2:
                printf("On-disk structure level of disk device %s is 2\n",
                    deviceName);
                break;
            case DVI$C ACP F11V5:
                printf("On-disk structure level of disk device %s is 5\n",
                    deviceName);
                break;
            default:
                printf("Device %s is not of a recognized on-disk structure level\n",
                    deviceName);
                printf("...ACP type code is %8.8X\n",
                    ACP_typeBuffer);
                break;
        }
        // end of "switch(ACP_typeBuffer)"
    }
    // end of "if (status & 1)"
    else // Call or queued request failed;
        lib$signal(status); // signal exception.
    // end of "main()"
}
```

## Locating and Naming Files on Disks

### 5.4 File Specification and Component Length Limits

#### 5.4.6 Using File Specification Defaults

When you omit file specification components (except for the node name and root name), RMS supplies default values for the missing components. The file specification to which defaults are applied is called the **primary file specification**. Your program can supply default values for all file specification components using either the **default file specification** or the **related file specification**. In addition, the process executing the program supplies specific default values for device and directory components, via the **process default specification**.

Where applicable, RMS substitutes the translated logical name to the primary file specification before it applies default values. After translating the primary file specification, RMS applies the defaults from the default file specification, then it applies the defaults from the related file specification, if relevant. RMS then applies the process default values, where applicable, for the device and directory to obtain the full file specification it uses to locate the file.

For more information about the application of defaults, refer to Section 6.1.

#### 5.5 Image Activation Using Logical Names

When an OpenVMS system activates an image, it uses RMS to open the image file. If the program specifies the image file with a logical name, RMS uses the equivalence name to look up the image in the *known file* list, unless the file specification includes a version number delimiter (a semicolon [;] or a period [.]). Known files are files that are installed using the Install utility, and the known file list provides a listing of these files by name and by number (file ID).

If RMS finds the file in the known file list, it uses the file number to access the file directly on disk and bring it into memory for execution. If the specified image file is not in the known file list, RMS goes through the time-consuming process of looking through the disk directories to find the file.

If you create a new version of an image but do not install it as a known image and do not remove the old version of the image from the known file list, the new image will not run.

Similarly, when you use a search list to specify the image, the known file lookup takes precedence. Until a lookup is successful or until the search list is exhausted, RMS executes a known file lookup for each element on the search list that does not include a file version delimiter. If it exhausts the search list, RMS uses the search list again, this time trying to locate and open the image file on disk.

If an older version of the image is included in the search list and if RMS finds the older version first, it will execute the older version and never look for the new version. Be sure to consider this when using search lists.

#### 5.6 Sample Use of Logical Names

Regardless of the programming language, you can use a logical name to provide components of a file specification. The following program example shows how to access a remote file. You access a remote file in the same way that you access a local file, except that the remote file specification includes a node name.

## Locating and Naming Files on Disks

### 5.6 Sample Use of Logical Names

Example 5-1 is a simple Fortran program that transfers a remote file on node TRNTO to the line printer on node BOSTON, using the logical names SRC and DST. You must define the logical name for the process before you run the program, using the following sequence of commands:

```
$ DEFINE SRC TRNTO::USER:[STOCKROOM.PAPER]INVENTORY.DAT
$ DEFINE DST BOSTON::LPA0:
$ RUN TRANSFER
```

In Example 5-1, standard I/O calls transfer the file's records from one device to another. Note the use of the OpenVMS file specification format with a remote node name. (If the remote node is running a system other than OpenVMS, the format of the file specification may differ.)

After opening the files and copying all the records, the program closes the channels, thereby terminating network operations. These operations are similar for applications in the other high-level languages.

## Locating and Naming Files on Disks

### 5.6 Sample Use of Logical Names

#### Example 5-1 Using Logical Names for Remote File Access

```
PROGRAM TRANSFER
C
C This program creates a sequential file with variable-length
C records from a sequential input file. The input and output
C files are identified by the logical names SRC and DST,
C respectively.
C
C CHARACTER BUFFER*132
C
100 FORMAT (Q,A)
200 FORMAT (A)
C
C Open the input and output files.
C
OPEN (UNIT=1,NAME='SRC',TYPE='OLD',ACCESS='SEQUENTIAL',
1 FORM='FORMATTED')
OPEN (UNIT=2,NAME='DST',TYPE='NEW',ACCESS='SEQUENTIAL',
1 FORM='FORMATTED',CARRIAGECONTROL='LIST',
2 RECORDTYPE='VARIABLE')
C
C Transfer records until end-of-file or other error condition.
C
10 READ (1,100,END=20,ERR=20) NCHAR,BUFFER(:NCHAR)
WRITE (2,200) BUFFER(:NCHAR)
GOTO 10
C
C Close the input and output files.
C
20 CLOSE (UNIT=2)
CLOSE (UNIT=1)
END
```

You can substitute the system logical name defined on a remote system as one or more of the components in the remote file specification, as follows:

- Device alone
- Both device and directory
- Complete file specification if it includes node

A logical name that includes the device, directory, and filename components but does not include the node, as illustrated in the following example, is not supported in a remote file specification:

```
$DEFINE/SYSTEM myfile work2:[user1]a.a
$DIRECTORY alpha"user1 password":myfile
%DIRECT-W-NOFILES, no files found
$DIRECTORY alpha"user1 password":myfile:
%DIRECT-E-OPENIN, error opening ALPHA"USER1 password":MYFILE:*.;* as input
-RMS-F-FNM, error in file name
```

Note that a foreign file specification would work:

```
$DIRECTORY alpha"user1 password"::"myfile"
Directory 0"user1 password"::
"WORK2:[USER1]A.A;2"
```

## Locating and Naming Files on Disks

### 5.7 Types of Logical Names

### 5.7 Types of Logical Names

When a logical name is defined, you can assign it various translation attributes including the **concealed** attribute and the **terminal** attribute. By default, a logical name is neither concealed nor terminal.

To specify a logical name as either concealed or terminal, use the `/TRANSLATION_ATTRIBUTES` qualifier for the DCL commands `DEFINE` or `ASSIGN`.

The terminal attribute indicates that the related logical name is the final name in the translation process. That is, no further translation is to be performed.

The concealed attribute ensures that RMS uses the device logical name when communicating with the application program. If the device logical name does not have the concealed attribute, any file specification information returned to the application program includes the device's physical name rather than its logical name. To illustrate, enter the following command sequence:

```
$ DEFINE/SYSTEM USERDISK DUA5:  
$ SET DEFAULT USERDISK:[JONES]  
$ DIRECTORY
```

The system responds with the following display, which identifies the device by its physical name (DUA5):

```
DIRECTORY DUA5:[JONES]  
FILE.TXT;1      FILE.TXT;2  
Total of 2 files.
```

Now enter the following command sequence:

```
$ DEFINE/SYSTEM/TRANSLATE=CONCEALED USERDISK DUA5:  
$ DIRECTORY
```

The system responds with the following display, which identifies the device by its logical name (USERDISK).

```
DIRECTORY USERDISK:[JONES]  
FILE.TXT;1      FILE.TXT;2  
Total of 2 files.
```

A search list is a logical name that contains more than one file specification. Typically a search list is used to search multiple file locations looking for a file. RMS attempts to locate the file by using the first file specification in the search list, then the next, and so forth until the file is found or the search list is exhausted. Like other logical names, a search list is usually defined using the `ASSIGN` or `DEFINE` commands; however, in a search list logical name, the multiple file specifications (equivalence names) must be separated by commas.

Any of the equivalence names in the search list may be specified individually as being terminal or being concealed. Section 6.2 describes the use of search lists and wildcard characters for multiple file processing and parsing. For general information about using logical names, refer to the *OpenVMS User's Manual*.

## 5.8 Introduction to File Parsing

RMS allows an application program to specify defaults for the device and directory components of a file specification as well as other components of a file specification. The method RMS uses to apply defaults and translate any logical names present is called **file parsing**. In effect, RMS merges the various default strings (after translating any logical names) to generate the file specification used to locate the file.

One of the functions of file parsing is to determine when a logical name is present and whether the file specification describes a file on the local node. If a node name is not present in the file specification (the file is located on the local system), RMS translates any logical names, applies defaults to any missing components, and then attempts to locate the file.

If a node name is present, RMS does not process the file specification on the local node. Instead, it merges any program-specified defaults without translation and passes the defaulted, untranslated file specification to the file access listener (FAL) at the remote node; the operating system on the remote node interprets it.

With advanced file parsing, a *single* file specification can be used to locate a single file or multiple files. To locate a single file, multiple file locations or file names can be searched to ensure that the file is found. The multiple file locations or file names can be located in the same or in different directories, on different devices, on different nodes, or a combination thereof. Using wildcard characters and search lists, you can locate multiple files with a single file specification.

When a wildcard character or a search list is included in a file specification, the application program may need to preprocess the file specification before attempting to locate the file. An RMS file service that operates on an unopened file (such as the Create service and the Open service) performs the following file-parsing tasks:

- Examines a file specification for validity
- Translates any logical names present
- Applies defaults
- Attempts to locate the file

If a name block is present, the service may also do the following file-parsing tasks:

- Returns the actual complete file specification used to access the file and its associated file identifier
- Returns the length of each component of a file specification as well as other information about the file specification

Some file services, including the Open and Create services, cannot process a file specification that contains wildcard characters. If a file specification contains wildcard characters, you must use the Search service to resolve the wildcard characters before you invoke the Open service or the Create service.

The Parse service determines whether wildcard characters or search lists are present, and it initializes control block fields that are necessary to search for multiple files using the Search service. To use the Search service, a name block (NAM or NAML) must be present when the Parse service is invoked.

## Locating and Naming Files on Disks

### 5.8 Introduction to File Parsing

Alternatively, you can use the SYS\$FILESCAN system service (scan string for file specification) to scan a file specification for validity and optionally return the lengths of the individual file specification components without translating logical names or applying defaults. Two Run-Time Library routines, LIB\$FIND\_FILE and LIB\$FILE\_SCAN, perform functions that are similar to the SYS\$SEARCH system service.

For more information about how RMS parses a file specification, see Section 6.1. For additional information about using directory specifications, including directory syntax conventions, see Section 6.3.

### 5.9 Using One File Specification to Locate Many Files

Five services can translate and apply defaults to a file specification to produce a fully qualified file specification: the Create, Open, Erase, Parse, and Rename services. Other file services must be preceded by one of these services to parse the file specification and, in some cases, to open the file.

If a file specification contains one or more wildcard characters, it must be preprocessed using the Parse and Search services before the file can be located. The Parse service sets bit values in the name block file name status bits field (NAM\$L\_FNB or NAML\$L\_FNB). This field can be tested to determine whether a wildcard character or a search list logical name is present. The Search service locates a file and specifies its name (without wildcard characters). If wildcard characters are present, you must first invoke the Search service before processing (opening or creating) the file; if wildcard characters are not present, the file can be processed without invoking the Search service.

To process a single file, you need to invoke the Search service only once; to process many files, invoke the Search service as many times as needed to return the next full file specification. When no more files match the file specification, the Search service returns a no-more-files-found message (RMS\$\_NMF).

In summary, the Parse and Search services work together to provide a fully qualified file specification that the Search service uses to locate the file.

Your program can process a single file without using the Search service if neither the file specification nor the search list contain wildcard characters. If any of the file specifications in a search list contain wildcard characters, the Search service must be invoked before processing the file to prevent an invalid wildcard completion status error. If a wildcard character is present in the second or subsequent file specifications in a search list, RMS does not set the wildcard bit in the file name status bits field.

If the Parse and Search services precede an Open service, an open-by-name-block operation should be performed by specifying the address of the name block in the name block address (FAB\$L\_NAM or FAB\$L\_NAML) field and setting the file-processing options (FAB\$L\_FOP) open-by-name-block (FAB\$V\_NAM) bit option.

Wildcard characters cannot be present in the file specification when the Create service is invoked. Sometimes the Parse service and the Search service precede a Create service.

When the create-if option bit (FAB\$V\_CIF) or the supersede option bit (FAB\$V\_SUP) is set in the file-processing options (FAB\$L\_FOP) field, the program may invoke the Parse service to check for wildcard characters or search lists in the file specification. If a search list or wildcard characters are found, the program must invoke the Search service before invoking the Create service.

## Locating and Naming Files on Disks

### 5.9 Using One File Specification to Locate Many Files

The create-if option tries to open any file found in the search list. If the file is not found in the search list, RMS creates it using the first file specification in the search list. If these options are specified and a wildcard character is present when the Create service is invoked, the file specification is invalid; if a search list is present, the file is created using the first file specification from the search list.

You can either call these services directly from a VAX MACRO procedure, as part of a USEROPEN or USER\_ACTION routine in a high-level language, or you may execute the calls from high-level language subroutines or functions that call RMS. The Parse and Search services require that a name block be present. Unless your language supports a means of setting values in a name block (and other control blocks) and invoking RMS, you should use a VAX MACRO procedure. FDL does not support the use of a name block.

In addition to a name block, you usually need a file access block (FAB) and a record access block (RAB). To perform file services, a FAB (and, if needed, extended attribute blocks [XABs]) must be present; to perform record services, a RAB must be present.

The following program shows how to use the LIB\$FIND\_FILE routine to locate the desired file, which the interactive user enters. Because LIB\$FIND\_FILE is used with the supplied arguments, the file specification may contain wildcard characters, a search list, and a search list that assumes the program will allow the use of “sticky” defaults, as in DCL command line parsing. The routine is called by the following VAX BASIC program USEROPEN option for the BASIC OPEN statement:

```
100 MAP (REC.1) SURNAME$ = 20%, REST$ = 60%
110 OPEN " " FOR OUTPUT AS FILE #1%, ORGANIZATION RELATIVE, &
      MAP REC.1, USEROPEN LOCATE
120 CLOSE #1%
130 END
```

The BASIC program allocates the control blocks before control is given to the USEROPEN routine; it also passes the address of the FAB as the first argument and the address of the RAB as the second argument. These arguments enable the VAX MACRO routine to obtain the control block addresses because the argument pointer points to the longword count of arguments, followed by the longword-length arguments. Because the VAX MACRO macros \$FAB and \$NAM are not used, access to the symbolic offset values defined for these control blocks is not available; thus, the \$FABDEF, \$NAMDEF and \$RABDEF macros define these symbols for the USEROPEN routine.

In addition to locating the file using any valid file specification, the called routine also connects to the file requesting 15 global buffers (or as many global buffers as system resources permit). This routine is linked with the BASIC program to form the executable image. Example 5–2 shows the routine.

## Locating and Naming Files on Disks

### 5.9 Using One File Specification to Locate Many Files

#### Example 5–2 Selecting the USEROPEN Option to Call a Routine

```

        .TITLE    LOCATE
        .PSECT   DATA,WRT,NOEXE
        .EXTERNAL LIB$SIGNAL,LIB$STOP,LIB$GET_INPUT,LIB$PUT_OUTPUT
        .EXTERNAL STR$GET1_DX
        $FABDEF                                     ; Define FAB symbols
        $RABDEF                                     ; Define RAB symbols
;
IFILE:  .BLKB   80                                 ; Input filespec
IFILED: .LONG   80                                 ; Filespec descriptor
        .ADDRESS IFILE
;
OFILED: .WORD   255                                ; Filespec descriptor
        .BYTE   DSC$K_DTYPE_T                     ; Specify character text
        .BYTE   DSC$K_CLASS_D                     ; Specify descriptor class
OFILE:  .LONG   0                                  ; Address set by STR$GET1_DX
;
DFILED: .ASCID  /.DAT/                             ; Default filespec descriptor
;
PROMPT: .ASCID  /Enter the filespec: /             ; User prompt
LOC P:  .ASCID  /** NOTE: Global buffers unavailable **/ ;
NULL_P: .ASCID  / /                                 ; Blank line prompt
;
ARGS:   .LONG   7                                  ; 7 arguments
        .ADDRESS IFILED                           ; Input filespec
        .ADDRESS OFILED                           ; Output filespec
        .ADDRESS CTEXT                             ; Context
        .ADDRESS DFILED                           ; Default filespec
        .ADDRESS NULL                              ; No related filespec
        .ADDRESS STV_L                             ; STV field
        .ADDRESS UFL$G$S                           ; User flags
CTEXT:  .LONG   0                                  ; Context work area
NULL:   .LONG   0                                  ; No related filespec
STV_L:  .BLKL   1                                  ; STV status return area
UFL$G$S: .BLKL  1                                  ; User flags
LEN:    .WORD   255
;
        .PSECT   CODE,NOWRT,EXE
        .ENTRY   LOCATE,^M<R6,R7>
;
        MOVL    4(AP),R6                           ; Move FAB address into R6
        MOVL    8(AP),R7                           ; Move RAB address into R7
        BISL2   #2,UFL$G$S                          ; Set flag for sticky defaults
TERR:   PUSHAL  IFILED                             ; Get input length
        PUSHAL  PROMPT                             ; Prompt for input
        PUSHAL  IFILED                             ; Input descriptor
        CALLS   #3, G^LIB$GET_INPUT                 ; Get input
        BLBC    R0,TERR                             ; Retry on error
        PUSHAL  OFILED                             ; Push descriptor address
        PUSHAL  LEN                                 ; And length
        CALLS   #2, G^STR$GET1_DX                   ; Allocate dynamic string
        BLBC    R0,ERR                             ; Branch on error
        CALLG   ARG$S, G^LIB$FIND_FILE              ; Call RTL Find File Routine
        BLBC    R0,ERR                             ; Branch on error
        BRW     OPEN                               ; Skip on success
ERR:    PUSHL   STV_L                               ; Signal error status
        PUSHL   R0_                                ; codes
        CALLS   #2, G^LIB$SIGNAL                    ; Display error
        BRW     TERR                               ; Reenter filespec on error

```

(continued on next page)

## Locating and Naming Files on Disks

### 5.9 Using One File Specification to Locate Many Files

#### Example 5–2 (Cont.) Selecting the USEROPEN Option to Call a Routine

```

OPEN:
    PUSHAL   OFILED                                ; Display filespec
    CALLS    #1, G^LIB$PUT_OUTPUT                 ; on screen
    MOVL     OFILE,R10                             ; Move filespec address to R10
    $FAB_STORE FAB=R6,FNA=(R10),FAC=GET,-
    FNS=OFILED,SHR=<GET,MSE>                       ; Set read-sharing global buffer
    $OPEN    FAB=R6                                ; Open the file
    BLBS     R0,CONNECT                           ; Branch on success
    PUSHL    FAB$L_STV(R6)                         ; Push STV and STS in reverse
    PUSHL    FAB$L_STS(R6)                         ; order on stack to
    CALLS    #2, G^LIB$STOP                        ; Signal error and stop
;
; This block of code attempts to Connect with global buffers if possible
; and uses local buffers if global buffer resources are not available.
; Because the global buffer value is set between the Open and Connect,
; all defaults are overwritten.
;
CONNECT:
    MOVL     #15,R9                               ; R9 contains global buffer count
    BRB      RETRY                                ; Skip local buffer handling
LOCAL:
    MOVL     #0,R9                               ; Turn off global buffers
    $RAB_STORE RAB=R7,MBF=#6                     ; Request 6 local buffers
    PUSHAL   LOC_P                               ; Inform user
    CALLS    #1, G^LIB$PUT_OUTPUT                 ; No global buffers
RETRY:
    $FAB_STORE FAB=R6,GBC=R9                     ; Override default global buffer
    $CONNECT RAB=R7                               ; Connect the record stream
    BLBC     R0,RERR                             ; Branch on error
    BRW      DONE                                ; On success, return
RERR:
    CML     R0,#RMS$_CRMP                         ; Test if too many global buffers
    BNEQ    CERR                                 ; Quit if other error
    CML     #4,R9                                 ; Test if too few global buffers
    BLSS    LOCAL                               ; Use local buffers
    SUBL2   #3,R9                                ; Decrement R9 by 3
    BRW      RETRY                               ; Attempt Connect again
CERR:
    PUSHL    RAB$L_STV(R7)                       ; Push STV and STS in reverse
    PUSHL    RAB$L_STS(R7)                       ; order on stack to
    CALLS    #2, G^LIB$STOP                        ; Signal and end on error
DONE:
    RET                                           ; Return to main program
    .END

```

Example 5–2 also shows the proper way to signal errors. The RAB\$L\_STS (completion status) field and the RAB\$L\_STV (additional status values) field of the FAB or RAB are used so that secondary completion information is displayed, if appropriate, by the LIB\$SIGNAL or LIB\$STOP routines.

The VAX MACRO program shown in Example 5–3 invokes the Parse service, determines whether a wildcard character or search list is present, and conditionally branches to a sequence of instructions that invoke the Search service followed by the Open service. The resultant string is displayed after the file is opened.

For more information about the LIB\$ routines, see the *OpenVMS RTL Library (LIB\$) Manual*.

The next example program uses the \$PARSE and \$SEARCH functions, demonstrates the use of C language's  *fopen*  function, and shows how you can mix RMS calls and C I/O calls.

## Locating and Naming Files on Disks

### 5.9 Using One File Specification to Locate Many Files

Example 5–3 uses `cc$rms_fab` and `cc$rms_nam` to define the `$FAB` and `$NAM` control blocks and specify the arguments for the Parse, and Search services.

The program shows how to preprocess a file specification using the Parse and Search services. First, the program prompts the user for an input file specification that may contain wildcard characters. The program then searches each file that matches the file specification for the specified text string.

Finally, the program outputs all records from the target files that contain the specified string.

#### Example 5–3 Using the Parse and Search Services

```
/* Using Parse and Search Services */
#include <stdio.h>
#include <ssdef.h>
#include <stsdef.h>
#include <string.h>
#include <rms.h>
#include <starlet.h>

#define MAXLINE 256

static int rms_status; /* RMS status variable */
static char ibuf[MAXLINE], /* input buffer */
           obuf[MAXLINE], /* output buffer */
           fbuf[MAXLINE], /* filename buffer */
           xbuf[MAXLINE]; /* expanded filename buffer */
struct FAB filfab; /* FAB for $PARSE and $SEARCH */
struct NAM filnam; /* NAM for $PARSE and $SEARCH */
void init() /* Initialize RMS structures */
{
    filfab = cc$rms_fab; /* Get a FAB */
    filfab.fab$l_fnā = ibuf; /* Parse filename from IBUF */
    filfab.fab$b_fac = FAB$M_GET; /* Only allow $GETs */
    filfab.fab$l_fop = FAB$M_NAM; /* Use the NAM block for filename */
    filfab.fab$l_nam = &filnam; /* -> NAM block */

    filnam = cc$rms_nam; /* Get a NAM block */
    filnam.nam$l_esā = xbuf; /* -> Expanded filespec buffer */
    filnam.nam$b_ess = 255; /* Expanded filespec buffer length */
    filnam.nam$l_rsa = fbuf; /* -> Resultant filespec buffer */
    filnam.nam$b_rss = 255; /* Resultant filespec buffer length */
}
main()
{
    auto FILE *fil; /* File pointer for file functions */
    auto int i; /* Generic loop variable */

    init(); /* Initialize RMS structures */

    /* Get filespec to search */
    fputs("File: ", stdout);
    if (!gets(ibuf)) return;

    /* Validate filespec */
    filfab.fab$b_fns = strlen(ibuf);
    if ((rms_status = sys$parse(&filfab)) & STS$M_SUCCESS) == 0)
        return (rms_status);

    /* Get search string */
    fputs("String: ", stdout);
    if (!gets(ibuf)) return;
```

(continued on next page)

## Locating and Naming Files on Disks

### 5.9 Using One File Specification to Locate Many Files

#### Example 5–3 (Cont.) Using the Parse and Search Services

```
/* Loop for all files matching filespec */
while ((rms_status = sys$search(&filfab)) & STS$M_SUCCESS)
{
  /* Output a row of asterisks, the filename,
   and other row of asterisks */
  for (i = 0; i < 80; i++)
    obuf[i] = '*';
  obuf[80] = '\0';
  puts(obuf);
  fbuf[filnam.nam$b_rsl] = '\0'; /* Add <NUL> terminator */
  puts(fbuf);
  puts(obuf);
  if (fil = fopen(fbuf, "r")) /* Try to open the file */
  {
    /* Process the file... */
    while (fgets(obuf, MAXLINE, fil))
      if (strstr(obuf, ibuf)) fputs(obuf, stdout);
    fclose(fil); /* Done with this file */
  }
  putchar('\f'); /* Print <FF> between files */
}
if ((rms_status == RMS$ FNF) || (rms_status == RMS$ NMF))
  rms_status = SS$ NORMAL; /* Handle expected errors */
return(rms_status);
}
```

An application may also need to process either one file or many files, depending on the file specification that the terminal user enters or the logical name that is provided (if the program uses a logical name in its file specification). Each of these cases is discussed in the following sections.

#### 5.9.1 Processing One File

When only a single file needs to be processed, but more than one location for the file may need to be searched, you can usually find the file by specifying a file specification that contains a search list.

For example, consider the case of a directory that contains the file PAY.DAT and a backup copy of the file named PAY\_BUP.DAT. You could specify a file name of PAY\*.DAT in the file specification and invoke the Parse service once and the Search service once to locate either of the two files; this method will locate PAY.DAT before PAY\_BUP.DAT.

A potential problem arises if the file PAY.DAT has been deleted or renamed. In this case, unless the program determines that the file specification is one of several that are acceptable, any file named PAY that has the file type .DAT could be accessed: for example, PAY\_ACC.DAT. You can avoid such problems by defining a search list logical name that specifies a search for PAY.DAT and PAY\_BUP.DAT. A search list named SEARCH could be defined as follows for the directory [SMITH]:

```
$ DEFINE SEARCH [SMITH]PAY.DAT,[SMITH]PAY_BUP.DAT
```

To locate the file, specify SEARCH as the primary file specification.

## Locating and Naming Files on Disks

### 5.9 Using One File Specification to Locate Many Files

When the file locations to be searched reside in different directories of a directory tree, you can use the ellipsis wildcard character in the directory field to search all subdirectories. Alternatively, you could define a search list that searches for the file PAY.DAT in one directory, the same file name in a subdirectory, and PAY\_BUP.DAT in any directory in the directory tree by using the following DEFINE command:

```
$ DEFINE SEARCH [SMITH]PAY,[SMITH.PAY]PAY,[SMITH...]PAY_BUP
```

You use the file specification SEARCH:.DAT to locate the desired file. In this example, note that one of the search list file specifications contains wildcard characters. Wildcard characters can be used in a search list if they are needed, just as with any other logical names and file specifications. However, the Parse and Search services must be used to locate the correct file.

When you need to locate files in different directory trees (or top-level directories), include complete directory specifications in your search list definition. For example, to locate the file TEST\_DATA.DAT in the device/directory combinations of DISK1:[SMITH], DISK2:[STATS], or DISK2:[SMITH] you could use the following command to define the search list TST:

```
$ DEFINE TST DISK1:[SMITH],DISK2:[STATS],DISK2:[SMITH]
```

You can also use search lists to locate files on different devices. To locate this file, you specify TST:TEST\_DATA.DAT.

To find the same directory and the same file name on different devices, you could use the following command to define TST:

```
$ DEFINE TST DISK1:,DISK2:,DISK3:
```

When you define the search list TST in this manner, you can locate the file by using the search list to specify the device name. In this way, you can use a single search list to locate files that would otherwise require multiple file specifications, even if wildcard characters were used.

#### 5.9.2 Processing Many Files

To process many files using a single file specification, you always need to use the Parse and Search services to locate the files.

The application requirements and the directory location of the files generally determine whether one or more search lists, wildcard characters, or search lists containing wildcard characters are used in the file specification. When files must be accessed in nonalphabetical order, use a search list.

To process multiple files using a single file specification, invoke the Parse service (or its equivalent) once to interpret the file specification and to create the file specification pattern to be searched. After the file specification is parsed, you can invoke the Search service to locate each file that matches the original file specification. In some cases, you can examine (or display) the resultant file specification string returned by the Search service to determine if you (or the interactive user) want to process (open) the file.

If you want to list all file specifications that match a particular file specification and let the terminal user choose each file to be processed, wildcard characters can be used safely, possibly in a search list that contains wildcard characters in one or more of its file specifications. To reduce the number of files that the user might choose to process, use a search list without wildcard characters or rely less on wildcard characters. For example, to locate all files in a directory tree on

## Locating and Naming Files on Disks

### 5.9 Using One File Specification to Locate Many Files

different devices with a file type of .DAT, you could define the search list TREE as follows:

```
$ DEFINE TREE DISK1:[MYDIR...],DISK2:[MYDIR...]
```

The primary file specification that would be used for the Parse service would be TREE:\*.DAT. A great number of files might match this.

For applications that will need to locate certain files, search lists with limited use of wildcard characters might be needed. Consider a file that contains a prefix of RESULTS followed by the date for which the data applies. You could use the file name RESULTS\*JUN\*.DAT to locate a record that was entered in the month of June by executing a Search service followed by an Open service for each file, reading all records until the correct one is found, and invoking the Close service after processing each file.

A search list should be used when a predefined group of files is processed by a program that is not intended to be interactive. Using a search list is particularly desirable if the files have unrelated file names or if they are located on different directories or devices. A search list also minimizes processing time by searching for a definite group of files.

#### 5.9.3 Processing One or Many Files

For general-purpose applications, when the user enters a file specification that may indicate one file or many files, there is a means of testing whether one file or many files are to be processed, or to explicitly disallow the use of wildcard characters for applications where only a single file should be processed. To test for wildcard characters or search lists, or both, invoke the Parse service and test the appropriate bits in the NAM\$L\_FNB or NAML\$L\_FNB field.

The presence of a wildcard character usually indicates that many files should be processed, depending on program conventions. If a search list is present, it may or may not indicate that only one file should be processed and a convention is needed for users of that program. Thus, by testing whether a wildcard is present, the program can either invoke the Parse service once and the Search service repeatedly for each file to be opened, or it can disallow wildcard characters and request that the file specification be reentered. In some cases, the program may need to disallow the use of a search list or allow one or many files to be accessed, depending upon application conventions.

If you want to disallow wildcard characters, invoke the Open service. The Open service fails when it encounters a wildcard character.



---

## Advanced Use of File Specifications

This chapter is intended for readers who want to better understand how OpenVMS RMS (hereafter referred to as RMS) internally applies defaults, parses file specifications, and handles directory specifications. This chapter also describes the use of rooted-directory syntax and process-permanent files.

### 6.1 How RMS Applies Defaults

This section describes how RMS applies defaults when it parses specifications supplied by your program.

Several file specifications can be used by RMS's Parse operation to compose a fully-qualified expanded file specification, which can then be used for operations such as searching for a specific file, opening an existing file, or creating a new file.

The program-supplied file specifications are the primary file specification, the default file specification, and one or more related file specifications. RMS also uses the process-default file specification, but it is not supplied by the program.

The program accepts from the user a file specification and passes it to RMS as the primary file specification.

The program provides to RMS, through the default file specification, components that RMS can use in place of missing components in the primary specification, and that are related to the program's function rather than to the files being operated on. Typically, the default file specification contains a default for the type component (for example, .DAT to specify a data file, or .TXT to specify a text file), or it contains default device and directory components.

The related file specification is used when two files are involved in an operation, such as copying or merging files, in which the input file specification can provide default components for the output file specification.

The final default mechanism, which is not provided by the program, is for RMS to use the process default device and directory. Table 6–1 describes the defaults that RMS uses to produce a complete file specification when these components (device and directory) cannot be obtained from the primary, default, and related file specifications.

## Advanced Use of File Specifications

### 6.1 How RMS Applies Defaults

**Table 6–1 File Specification Defaults**

| File Specification   | Description   |
|----------------------|---|
| Primary              | If the device field is a logical name, RMS translates the logical device name to its component parts. The resulting device name may be a physical device name, a process-permanent file name, or another logical name.  |
| Default              | If the device field is a logical name, RMS translates it before defaults are applied. If any of the fields in the file specification from the previous step are missing, they are supplied from the corresponding fields in the translated default file specification, where applicable.  |
| Related              | If the device field is a logical name, RMS translates it and applies the default values before it uses the related file specification to add missing component fields. If fields contain wildcard characters, the wildcard characters remain in the fields. When RMS uses the related file specification to complete an output file specification, the file name field and the file type field are replaced by the corresponding related file specification fields, where applicable. For more information, including the use of multiple related file specifications, see Section 6.2.3. |
| Device and Directory | If the device name is omitted, the device field and, optionally, the directory field accept the system logical name SYS\$DISK. If RMS cannot translate the logical name SYS\$DISK to a physical device name, an error occurs. If the directory field does not accept the logical name SYS\$DISK, it accepts the name of the current process default directory.  |

Primary, default, and related file specifications can use logical names. RMS translates the primary file specification before it applies defaults and missing components. RMS also translates the default file specification before using the default values. Finally, RMS translates the related file specification before it uses missing components supplied by the related file specification. If the file specification is still missing the device or directory name components, the process executing the program supplies default device and directory values.

The algorithm used in determining the appropriate translation is as follows:

```
if node name present
  then translate node name
else if device name present
  then translate device name
else if only file name present
  then translate file name
```

For the remainder of this description, the component parts of the file specification are referred to as strings. For example, the device component is referred to as the device string; the name component is the name string, and so forth. Furthermore, as components are added to a file specification, the expanded file specification is referred to as the expanded string. Finally, the resultant file specification is called the resultant string.

Table 6–2 shows the sequence in which defaults are applied to a file specification (primary file specification string) and the resulting file specification (resultant string). In Table 6–2, the program specifies the primary file specification string FILE, omitting all other components of the file specification. The default file specification string .DAT provides the file type component. The related file specification string does not provide any component strings, but the default device

## Advanced Use of File Specifications

### 6.1 How RMS Applies Defaults

string (logically SYS\$DISK) provides the device string DISK1: and the directory string, [INV\_C], is provided by the default directory string. Finally, because the resultant string is used to specify a new file, RMS applies the version number 1 to complete the new file specification.

**Table 6–2 Example of Applying Defaults**

| String Name                | String Applied | Expanded String         |
|----------------------------|----------------|-------------------------|
| Primary file specification | FILE           | FILE                    |
| Default file specification | .DAT           | FILE.DAT;               |
| Related file specification | None.          | FILE.DAT;               |
| Default device (SYS\$DISK) | DISK1:         | DISK1:FILE.DAT;         |
| Default directory          | [INV_C]        | DISK1:[INV_C]FILE.DAT;  |
| Resultant string           |                | DISK1:[INV_C]FILE.DAT;1 |

RMS appends the version number to the expanded string to convert it into the resultant string. The resultant string is the resultant file specification that RMS uses to locate the file.

When coding the file specification information in a program, you can use the language keyword for the OPEN (or CREATE) statement. Then you use the FDL Editor to enter the file specification characteristics. Finally, you call the FDL\$CREATE routine to create a file, or you call the FDL\$PARSE routine and the FDL\$RELEASE routine to open a file.

Alternatively, you can set the appropriate control block fields and call the RMS services directly, perhaps as part of a USEROPEN routine or a USER\_ACTION routine.

Consider a program that does not explicitly specify the device and directory in any of the file specifications and does not have a related file specification. RMS adds the current process default device and the current process default directory to the expanded string after it applies components provided by the default file specification. However, if the program looks for a data file that is not in the current process default device and directory, it does not find the file. In this case, the solution is to specify the data file's device and directory either in the primary file specification, the default file specification, or the related file specification.

The program-supplied file specifications can be specified using the methods summarized in the following chart:

| File Specification | How You Can Specify It   |
|--------------------|--|
| Primary            | Use the FDL attribute FILE_NAME; use the file name or the name following the FILE, FILE_ID, or FILENAME keywords in the OPEN statement in some high-level languages; or use the string pointed to by the FAB field FAB\$L_FNA.                             |
| Default            | Use the FDL attribute FILE DEFAULT_NAME; use the default file specification or the name following the DEFAULTNAME or DEFAULT_FILE_ID keyword in the OPEN statement in some high-level languages; or use the string pointed to by the FAB field FAB\$L_DNA. |

## Advanced Use of File Specifications

### 6.1 How RMS Applies Defaults

| File Specification | How You Can Specify It   |
|--------------------|--|
| Related            | Use the name block (NAM) pointed to by the NAM\$L_RLF field; the related name block must specify the location of a file specification, which must be pointed to by the NAM field NAM\$L_RSA. |

Specifying all components in the primary file specification explicitly decreases the chance of error. However, defaults are provided and can be very useful, especially for general-purpose applications and for applications in which the file specification is entered by the interactive user. Another option to consider is the use of logical names.

See the appropriate languages documentation for information about language statements and their keywords. Consult the *OpenVMS Record Management Utilities Reference Manual* for information about the FDL Editor, and refer to the *OpenVMS Utility Routines Manual* for information about the FDL\$PARSE and FDL\$RELEASE routines. For detailed information about RMS control blocks and services, see the *OpenVMS Record Management Services Reference Manual*.

### 6.2 Understanding RMS Parsing

In the following text, the term **expanded string buffer** refers to the user-allocated buffer that is pointed to by the NAM block expanded string address field (NAM\$L\_ESA), by the NAML block short expanded string address field (NAML\$L\_ESA), or by the NAML block long expanded string address field (NAML\$L\_LONG\_EXPAND).

As it processes each program-supplied file specification, RMS identifies each specification's component parts. Components present in the primary, default, or related, and process-default file specifications are used to form the expanded file specification. The expanded file specification can then be used to locate one or more files. If a name block (NAM or NAML) is present, and the address and size of the expanded string buffer are specified, the file specification is copied into the expanded string buffer.

Note that the Parse service operates differently from other services with regard to the expanded string. With the Parse service, the expanded string contains all wildcard characters present in the file specification. RMS does not generate the resultant string until the program invokes a related service, such as SYS\$SEARCH, which uses the expanded string from the Parse service as input.

When you use a search list, the expanded string contains the *first* location to be searched. RMS stores internally the information that specifies the remaining search list equivalence strings. Note that the equivalence string from a \$PARSE is not guaranteed to point to an actual file. As different file locations are examined, RMS updates the expanded string to reflect the current location, and the resultant string contains the actual file specification of the file.

With the Create, Display, Erase, Open, and Search services, defaults are applied to the expanded string to select the actual file used. The resultant string can be used by the program to indicate which file was located. When the file is located, the version number found (or created) is appended to the resultant file specification string (not the expanded file specification string). When a search list is used, the resultant string contains the file specification where the file was actually found.

The following sections describe the steps that RMS uses to create a complete file specification.

### 6.2.1 Checking for Open-by-Name Block

If the open-by-name-block option is specified (FAB\$V\_NAM), RMS examines the name (NAM or NAML) block for a valid device identification field (NAM\$T\_DVI or NAML\$T\_DVI), directory identification field (NAM\$W\_DID or NAML\$W\_DID), and file identification field (NAM\$W\_FID or NAML\$W\_FID). If these fields are present, RMS uses them to locate the file; all other components are ignored because they are not needed. If the open-by-name block succeeds, no expanded or resultant string is produced.

If these fields are not present in the name block or if an open-by-name block is not specified (for example, an Open service not preceded by a Parse service), RMS performs the translation and application of defaults. A file can also be created using the name block device and directory identification fields, but RMS does not use the file identification.

If an open-by-name block is requested for remote DECnet for OpenVMS file access between two OpenVMS systems, RMS does not check the device identification, directory identification, or file identification to determine whether the requested open-by-name block operation can be performed. Instead, RMS checks to see if a qualified resultant string is present. If a qualified resultant string is not present, RMS translates logical names and applies defaults as if an open-by-name block operation was not requested (see Section 6.2.2).

### 6.2.2 File Specification Formats and Translating Logical Names

To form the file specification, RMS examines and attempts to translate each program-supplied file specification, beginning with the primary file specification string indicated by the contents of the FAB\$L\_FNA and FAB\$B\_FNS fields, or by the contents of the NAML\$L\_LONG\_FILENAME and NAML\$L\_LONG\_FILENAME\_SIZE fields.

A file specification may have one of three formats:

- The first file specification is in the following format:

```
node::"foreign-filespec" node::"task-spec-string"
```

RMS attempts to translate the node name so that it can determine whether a logical node name is present. Only a logical or physical node name (including an access control string, if present) is allowed if the translation is successful. If a logical node name is found, the translation is repeated. When translation cannot be performed, the file specification is copied directly into the expanded string. The quoted string is not parsed except to determine if it refers to a file or a task on the remote system. For additional information about these formats, see the *DECnet for OpenVMS Networking Manual*.

- If the file specification contains only a name (without a terminating period or colon), RMS attempts to translate it as a logical name. If the file name field is translated successfully, the entire translation operation restarts, using the equivalence string as input. If the file name field is not translated successfully, RMS uses it as the file name component.
- If the file specification is not in either of the formats described previously, RMS assumes it to be in the following file specification format:

```
node::device:[root.][directory]filename.type;version
```

## Advanced Use of File Specifications

### 6.2 Understanding RMS Parsing

Note that in the context of a file specification, brackets do not imply optional components. The only optional components are the node component and the root component.

RMS isolates the components, checks them for proper syntax, and copies them to the expanded string. If a node name is present, RMS attempts to translate it as a logical node name as described previously. If a name in the device component is present and the node name is omitted, RMS attempts to translate the device name as a logical name.

After translating a logical name, RMS determines whether the translation contains a duplicate component. If RMS finds a duplicate component in the primary file specification translation, it signals an error. Conversely, if RMS finds a duplicated component in the default string file specification translation or in the related string file specification translation, it ignores (discards) the duplicate component.

If the node name is omitted and the device component does not translate successfully, RMS treats the name in the device component as a device name.

If the logical name translates successfully, RMS makes several checks and then performs the appropriate task:

- Checks the equivalence string to determine whether it refers to a process-permanent file. If the equivalence string refers to a process-permanent file, defaults are not needed so RMS stops processing the file specification and copies the logical name to the expanded string. Process-permanent files are described in Section 6.6.
- Checks the equivalence string to determine whether the logical name is a concealed-device logical name. If the logical name is a concealed-device logical name, and if no concealed-device logical names have been encountered previously in the device file specification, the source string is used as the device name.
- Restarts the translation operation using the equivalence string as input, if the equivalence string does not contain a process-permanent file and does not have the terminal attribute.

If a node name is present, RMS passes the entire file specification (without the node name) to the remote node for interpretation, using the DECnet data access protocol (DAP) to communicate with the DECnet file access listener (FAL) at the remote node.

The logical name translation procedure reveals two conventions. First, if the file specification has been parsed previously by an RMS file service, it uses the open-by-name-block option to save processing time. Second, a logical device name must be placed at the beginning of a file specification, unless it is preceded by a node name that indicates the node where the logical name should be translated.

#### 6.2.3 Special Parsing Conventions

Additional parsing conventions for advanced file specifications include search lists, related file specifications, and the way RMS handles directory specifications.

### 6.2.3.1 Parsing Conventions for a Search List

RMS uses several conventions when processing a search list logical name.

- When RMS encounters a search list, it searches internally for the file using search list file specifications previously specified. RMS treats each file specification in the search list as a new file specification. That is, RMS does not use components of one file specification element in the search list as the default for subsequent elements in the search list.

- When it uses search lists, RMS ignores the following errors:

- Invalid device name (RMS\$\_DEV)
- Device not ready or not mounted (RMS\$\_DNR)
- Directory not found (RMS\$\_DNF)
- File not found (RMS\$\_FNF)
- Privilege violation (RMS\$\_PRV)

All other errors terminate search list processing.

- When a search list is embedded (nested) in another search list, all file specifications of the nested search list are processed before the file specifications in the next-higher search list level. Therefore, RMS permits iterative substitution in nested search lists as it does with other logical names. For example, consider the following search lists, X and Y:

```
$ DEFINE X DISK1:[RED],DISK2:[WHITE]
$ DEFINE Y X,DISK1:[BLUE]
```

The following search order is derived from search list Y:

1. DISK1:[RED]
2. DISK2:[WHITE]
3. DISK1:[BLUE]

- When opening a file, RMS tries all search list possibilities before it signals an error completion status. If RMS cannot find the file, it displays, where applicable, the final search list file specification and the error message.
- When RMS tries to locate a file using multiple search lists, it uses all combinations of the elements in the search lists. First it combines the first entry in the first list with the first entry in the second list. Then it combines the first entry in the first list with the second entry in the second list. After trying all combinations of the first entry in the first list with all entries in the second list, RMS repeats the exercise using the entries in the second list with the second entry in the first list. This continues until RMS locates the file or until it tries all combinations of all lists.

For example, assume the program is looking for FILE.DAT, which may be in one of two directories, [BIG] or [BEST], on one of two disks, DISK1: or DISK2:. First, the program defines two search lists, a disk search list (PRIM) and a directory search list (DEF):

```
$ DEFINE PRIM DISK1,DISK2
$ DEFINE DEF [BIG],[BEST]
```

Next, the program provides a primary file specification that includes the search list (PRIM) for the disk together with the file name component:

```
PRIM:FILE
```

## Advanced Use of File Specifications

### 6.2 Understanding RMS Parsing

Finally, the program must provide the default specification that includes the search list (DEF) for the directory together with the file type component:

DEF:.DAT

Given this information, RMS looks for FILE.DAT using the file specification data in the following order:

| Primary File Specification | Default File Specification | Expanded String       |
|----------------------------|----------------------------|-----------------------|
| DISK1                      | [BIG]                      | DISK1:[BIG]TEST.DAT;  |
| DISK2                      | [BIG]                      | DISK2:[BIG]TEST.DAT;  |
| DISK1                      | [BEST]                     | DISK1:[BEST]TEST.DAT; |
| DISK2                      | [BEST]                     | DISK2:[BEST]TEST.DAT; |

Now, assume the program provides a related file specification with a search list for FILE.DAT.

1. RMS uses all combinations of the search list elements in the primary and default file specifications with the *first* component (device) of the related file specification.
2. RMS uses all combinations of the search list elements in the primary and default file specifications with the *second* component (directory) of the related file specification.
3. RMS repeats steps 1 and 2 with each search list element in the related file specification.

#### 6.2.3.2 Special Processing for a Related File Specification

This section describes the special processing needed to implement sticky defaults when a search list is used in a related file specification for an input file parse. The term **sticky default** means that file specification components from the first file specification are applied as defaults to the next file specification component, eliminating the need, for instance, to specify the device specification for each file specification when all the files are located on the same device.

The related file specification provides defaults when a related file name block is present. To use the related file specification, the file access block must specify the address of the primary file's name block (in the FAB\$L\_NAM or FAB\$L\_NAML field), and that name block must specify the address of the related file's name block (in the NAM\$L\_RLF or NAML\$L\_RLF field). The related file's name block must specify the address of a valid file specification in the resultant string (NAM\$L\_RSA/NAM\$B\_RSS or NAML\$L\_LONG\_RESULT/NAML\$L\_LONG\_RESULT\_ALLOC) field. Typically, an RMS file service (other than Parse) places the file specification in the resultant string.

You can specify whether the related file is used as an input file specification or an output file specification by setting (output file specification parsing) or resetting (input file specification parsing) the output-file parse (FAB\$V\_OFP) bit in the file-processing options (FAB\$L\_FOP) field .

When an input file specification is being parsed, you can have multiple related name blocks by specifying the second related file's name block address in the NAM\$L\_RLF or NAML\$L\_RLF field of the first related name block, the address of the third related name block in the NAM\$L\_RLF or NAML\$L\_RLF field of the second name block, and so forth. The use of multiple related name blocks

## Advanced Use of File Specifications

### 6.2 Understanding RMS Parsing

is especially useful for search lists; one related name block might contain a file type that can be used by any file specification in a search list, another might contain the full file specification that was produced by the first search list file specification, and another might contain the full file specification produced by the second search list file specification. This method allows the file specifications in a search list to provide sticky defaults, a characteristic associated with DCL command lines that contain multiple file specifications.

For a search list to be applied as a related file specification, the related file specification must not be a resultant string but must include the search list logical name. The related file specification in this case must describe the original primary file specification. For example, consider the following search list definition:

```
$ DEFINE WORK DISK1:[MINE],DISK2:[GROUP]
```

To process lists of input files—such as WORK:A,B,C,—your program must supply the string WORK:A as the related file specification, not DISK2:[GROUP]A.DAT. The routines LIB\$FIND\_FILE and LIB\$FILE\_SCAN are provided to perform this special processing; consult the *OpenVMS RTL Library (LIB\$) Manual* for additional information; also refer to Example 5–2, which shows how to call the LIB\$FIND\_FILE routine.

#### 6.2.3.3 Input File Specification Parsing

When the output-file parsing bit (FAB\$V\_OFFP) is reset and the node name is omitted, RMS processes the related file specification as an input file specification. This is shown in the following table. Note that the only wildcard character allowed is a single asterisk.

| File Specification Component | Null Field Specification       | Wildcard (*) Field Specification |
|------------------------------|--------------------------------|----------------------------------|
| Node                         | Use related file specification | Illegal                          |
| Device                       | Use related file specification | Illegal                          |
| Directory                    | Use related file specification | Remains wild                     |
| Filename                     | Use related file specification | Remains wild                     |
| Type                         | Use related file specification | Remains wild                     |
| Version                      | Remains null                   | Remains wild                     |

When the FAB\$V\_OFFP bit is reset and a node name is present, RMS processes the related file specification as an input file specification, as shown in the following table:

| File Specification Component | Null Field Specification | Wildcard (*) Field Specification |
|------------------------------|--------------------------|----------------------------------|
| Device                       | Remains null             | Illegal                          |
| Directory                    | Remains null             | Remains wild                     |

## Advanced Use of File Specifications

### 6.2 Understanding RMS Parsing

| File Specification Component | Null Field Specification       | Wildcard (*) Field Specification |
|------------------------------|--------------------------------|----------------------------------|
| Filename                     | Use related file specification | Remains wild                     |
| Type                         | Use related file specification | Remains wild                     |
| Version                      | Remains null                   | Remains wild                     |

#### 6.2.3.4 Output File Specification Parsing

When the FAB\$V\_OFP bit is set and a node name is not present, RMS processes the related file specification as an output file specification, as shown in the following table:

| File Specification Component | Null Field Specification       | Wildcard (*) Field Specification                             |
|------------------------------|--------------------------------|--|
| Node                         | Remains null                   | Illegal  |
| Device                       | Remains null                   | Illegal  |
| Directory                    | Remains null                   | Substitute from related file specification with restrictions |
| Filename                     | Use related file specification | Substitute from related file specification                   |
| Type                         | Use related file specification | Substitute from related file specification                   |
| Version                      | Remains null                   | Substitute from related file specification                   |

When the FAB\$V\_OFP bit is set and a node name is present, RMS processes the related file specification as an output file specification, as shown in the following table:

| File Specification Component | Null Field Specification       | Wildcard (*) Field Specification                             |
|------------------------------|--------------------------------|--|
| Device                       | Remains null                   | Illegal  |
| Directory                    | Remains null                   | Substitute from related file specification with restrictions |
| Filename                     | Use related file specification | Substitute from related file specification                   |
| Type                         | Use related file specification | Substitute from related file specification                   |
| Version                      | Remains null                   | Substitute from related file specification                   |

As shown in the previous table, a wildcard character in an output directory specification is subject to the following syntax restrictions:

- Only the asterisk and the ellipsis are permitted in the output directory specification. In the case of a related file specification, you may choose either the asterisk or the ellipsis (but not both) in the output directory specification unless you use the following form:

[\*...]

## Advanced Use of File Specifications

### 6.2 Understanding RMS Parsing

- A subdirectory specification that contains wildcard characters cannot be followed by a subdirectory specification that does *not* contain wildcard characters.
- Specifications in the UIC directory format may receive defaults only from directories in the UIC directory format.
- Specifications in the non-UIC directory format may receive defaults only from directories in the non-UIC directory format.
- Specifications in the non-UIC directory format that consist entirely of wildcard characters may receive related file specification defaults from directories in UIC or non-UIC format.

RMS processes wildcard characters in an output directory specification as follows:

- If you specify an output directory using a specification that consists entirely of wildcard characters (only [\*] and [\*...] are allowed), RMS accepts the complete directory component from the related file specification. This permits you to duplicate an entire directory specification.
- If you specify an output directory with a trailing asterisk (for example, [A.B.\*]), RMS substitutes the first “wild” subdirectory from the related file specification. This substitution permits you to move files from one directory tree to another directory tree that is not as deep as the first one.
- If you specify an output directory with a trailing ellipsis (for example, [A.B...]), RMS substitutes the entire “wild” subdirectory from the related file specification. This substitution permits you to move entire subdirectory trees.
- The related name block must have the appropriate file name status bits set in the NAM\$L\_FNB or NAML\$L\_FNB field set according to the resultant string to allow RMS to identify the “wild” portion of the resultant string.

### 6.3 Directory Syntax Conventions and Directory Concatenation

One of the components of a file specification is the directory specification. RMS supports two conventions or types of directory specifications, one of which is used more often than the other.

When RMS applies defaults to a directory specification in a file specification, the rules differ depending on what type of a directory specification is present. Two directory syntax conventions are available to access directories: normal and rooted. The default directory access is normal syntax. That is, you can specify the directory desired using the directory syntax described in the *OpenVMS DCL Dictionary*.

#### 6.3.1 Using Normal Directory Syntax

There is a master file directory (MFD) on each volume. Within each MFD, top-level directories are cataloged using the DCL command CREATE/DIRECTORY (or equivalent record management services). Beneath each top-level directory, you can create subdirectories referenced from the top-level directory.

## Advanced Use of File Specifications

### 6.3 Directory Syntax Conventions and Directory Concatenation

Once the subdirectories are created, you can create subdirectories referenced from each subdirectory. You can create a large number of levels of subdirectories beneath a top-level directory. The subdirectories created beneath a directory and the subdirectories within the subdirectories (and so forth) are called collectively a **directory tree**. The base point for normal directory syntax access can be relative to the current position in the directory tree or an absolute reference that explicitly or by default states any higher-level directories or subdirectories needed to identify the appropriate directory or subdirectory. An absolute directory reference begins with a directory name; a relative directory reference begins with a hyphen (-) or a period (.). An absolute reference might include the name of the top-level directory and one or more subdirectories. A relative directory reference relies on the use of the process-default directory and device, which are set using the DCL command SET DEFAULT. Refer to the *OpenVMS DCL Dictionary* for additional information and examples.

A relative directory reference can be in one of several forms. Assume the current directory position (process-default directory) is [SMITH.JONES].

- You can specify a lower level in the directory tree with a period (.) to indicate that the current directory position ([SMITH.JONES]) is prefixed to the specified directory as shown in the following command:

```
$ SET DEFAULT [ .DATA]
```

This directory specification is combined with the current directory position to form [SMITH.JONES.DATA].

- You can specify higher levels in the directory tree by beginning the directory specification with a hyphen (-) to indicate that the directory specification is the next level up from the current directory level. If you are currently at directory level [SMITH.JONES], the following command directs RMS to use the directory SMITH:

```
$ SET DEFAULT [-]
```

If you include more than one hyphen, RMS ascends the directory tree by a corresponding number of levels. For example, if you use the following command from directory level [RED.WHITE.BLUE], RMS moves up the tree to level [RED]:

```
$ SET DEFAULT [- -]
```

- You can use combinations of hyphens and periods to traverse a directory tree. For example, assume the following directory tree structure:

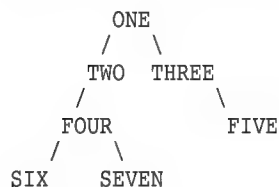

Assume that your process is in directory [ONE.TWO.FOUR.SIX] and you want to access a file in [ONE.THREE.FIVE]. You can do this with the following DCL command:

```
$ SET DEFAULT [- - -.THREE.FIVE]
```

## Advanced Use of File Specifications

### 6.3 Directory Syntax Conventions and Directory Concatenation

- You can refer to the default directory explicitly by specifying an empty directory specification at the DCL prompt. This feature is useful when you want to use a single DCL command to perform directory operations in your default directory and one other directory.

For example, assume you have a directory on device USERDISK named [CUSTOMERS.LOCAL] that contains three files: ABERCROMBIE, FITCH, and GOULD. Another directory named [CUSTOMERS.INTERNATIONAL] also contains three files: MERRILL, LYNCH, and PIERCE. Assume that your default directory is [CUSTOMERS.LOCAL] but you need a directory listing that contains the sizes of all customer files. You can list both directories using the following command line:

```
$ DIRECTORY/SIZE [CUSTOMERS.INTERNATIONAL],[]
```

DCL responds to this command with the following display:

```
Directory USERDISK:[CUSTOMERS.INTERNATIONAL]
```

|         |      |
|---------|------|
| MERRILL | 1100 |
| LYNCH   | 155  |
| PIERCE  | 645  |

```
Directory USERDISK:[CUSTOMERS.LOCAL]
```

|             |     |
|-------------|-----|
| ABERCROMBIE | 230 |
| FITCH       | 100 |
| GOULD       | 355 |

```
Total of 6 files, 2585 blocks
```

A directory name at the leftmost end of a directory specification is interpreted as a top-level directory, or an absolute directory reference. The syntax shown for the following specification refers to a top-level directory named GREEN, regardless of the current default directory:

```
[GREEN]
```

Conversely, a period or a hyphen before a directory name is always associated with a relative directory reference.

Note that because only one directory can be directly above any other directory, you can use a hyphen without explicitly naming the next higher directory. But, because many directories can be directly beneath the current directory, you must explicitly specify the directory at the next lower level by following the period with the name of the selected directory.

If the program omits either the device or the directory component in a file specification, RMS accepts the value of the current device and directory from the logical translation of SYS\$DISK. Therefore, any directory fields yielded by translation of SYS\$DISK override the process default directory. If translation of SYS\$DISK does not yield the directory element, RMS uses the process default directory. Note that you can change the process default directory with the SET DEFAULT command or by invoking the SYS\$SETDDIR system service.

## Advanced Use of File Specifications

### 6.3 Directory Syntax Conventions and Directory Concatenation

#### 6.3.2 Rooted-Directory Syntax Applications

Rooted-directory syntax allows you to refer to directory trees as logical devices and top-level directories. A reference to a top-level directory actually accesses existing subdirectories without program modification; thus, rooted-directory syntax extends the flexibility associated with logical names. Similarly, rooted-directory syntax can reduce the number of top-level directories needed for a volume. Rooted-directory syntax allows multiple system directory trees to exist on a single system volume.

You specify rooted-directory syntax using a logical name in a program-specified file specification or in the device and directory for a SET DEFAULT command. If a program specifies a logical device name in the file specification, the logical device name can be redefined to specify a rooted-directory logical name. Redefining the logical device name to specify a rooted directory changes the directory (and the file or files) accessed by the program without modifying the program.

If a program does not specify a logical device name in the file specification, the user (or a command procedure) can issue DEFINE commands and the SET DEFAULT command before running the program to indicate the use of rooted-directory syntax and to specify the process-default device/directory. Using the SET DEFAULT command changes the directory accessed by the program without requiring that you modify the program. When the program finishes, use the SET DEFAULT command again to specify the new process-default device/directory and to resume the use of normal directory syntax (if desired).

Using rooted-directory syntax as illustrated in the preceding text provides several advantages. Because you did not modify the program, you avoided having to recompile (or reassemble), relink, or retest it. Another advantage is that because you were able to run the program from its resident directory, you eliminated the overhead of having to move the file several times.

#### 6.3.3 Using Rooted-Directory Syntax

Rooted-directory syntax provides a way of making a directory or subdirectory appear to the user as the master file directory (MFD) for the logical disk volume. Subdirectories of the rooted directory appear as top-level directories (user file directories) for the logical volume.

The **root directory** is the directory you specify during logical name definition that serves as a base from which you can access the directories beneath it.

---

#### Note

---

Octal group and member directory designations, for example, [1,4] are not allowed in rooted directories.

---

A concealed-device logical name that defines a hidden root directory is called a **rooted-device logical name**.

When you define the rooted-device logical name for use in a program in a SET DEFAULT command, you specify that the logical name is a concealed-device logical name by using the /TRANSLATION\_ATTRIBUTES=CONCEALED qualifier with the DCL command DEFINE or ASSIGN. To define the concealed-device logical name as a rooted-device logical name, the root directory must contain a trailing period (.), such as DUA22:[ROOT.]. When specifying a directory, you can only use a trailing period for the root directory.

## Advanced Use of File Specifications

### 6.3 Directory Syntax Conventions and Directory Concatenation

When you define a root directory, all directory references refer to the specified root directory or directories beneath it in the directory tree. A reference to a top-level directory refers to a subdirectory of the specified root directory when using rooted-directory syntax. This is consistent with the fact that the root directory appears as the MFD because a reference to directory [000000] refers to the root directory. When you execute the SHOW DEFAULT and other direct commands, the system displays the root directory as [000000]. Note that the directory specification form [0,0] for the MFD is not valid when using rooted-directory syntax.

For example, assume the top-level directory [ROOT1] on disk DUA7 contains a subdirectory [ROOT1.SUB]. The directory [ROOT1] is defined as the root directory associated with the logical name BASE as follows:

```
$ DEFINE BASE DUA7:[ROOT1.]
```

When you associate the root directory with the logical name base, you can refer to the logical top level directory [ROOT1.SUB] using the syntax BASE:[SUB]. The following chart provides a summary of the actual directory accessed and the equivalent rooted-directory syntax that applies to this example:

| Actual Directory | Rooted Syntax | Comments                                     |
|------------------|---------------|--|
| DUA7:[ROOT1]     | BASE:[000000] | [ROOT1] appears as the MFD                   |
| DUA7:[ROOT1.SUB] | BASE:[SUB]    | [ROOT1.SUB] appears as a top-level directory |

The next example shows how to define the root logical name described in the previous chart and how to access a subdirectory of the specified root directory. Note that the trailing period [ROOT1.] indicates that a root directory is present.

```
$ DEFINE/TRANSLATION ATTR=CONCEALED BASE DUA7:[ROOT1.]
$ SET DEFAULT BASE:[SUB]
$ DIRECTORY *.DIR,[-]*.DIR
```

The system responds with the following display:

```
BASE:[SUB]
SUBSUB.DIR
BASE:[000000]
SUB.DIR
```

In the preceding example, the SET DEFAULT command defines the process-default directory as [ROOT1.SUB] using the rooted-device logical name BASE. The DIRECTORY command looks for directory files in the current directory ([ROOT1.SUB]) and then in the directory directly above it ([ROOT1]). The directory [ROOT1.SUB] is listed (by the DIRECTORY command) as a top-level directory (BASE:[SUB]) and the root directory is listed using the syntax of the MFD, BASE:[000000].

#### 6.3.4 Concatenating Rooted-Directory Specifications

When it concatenates specifications for rooted directories, RMS uses different syntax rules than it uses when it concatenates directory specifications for normal directory syntax.

One difference between the two conventions is associated with the trailing period in the root directory definition. For example, consider how a top-level directory reference is handled. With rooted-directory syntax, the root directory's trailing period is implied as a leading period in subsequent rooted-directory references.

## Advanced Use of File Specifications

### 6.3 Directory Syntax Conventions and Directory Concatenation

Directory concatenation *within the same file specification* occurs only with a rooted-device logical name. Normal directory concatenation occurs only through the application of defaults. Rooted-directory concatenation can occur within the same file specification and through the application of defaults. Rooted-device logical names specify a device name and a root directory. RMS translates a rooted-device logical name into the device and root directory before it merges any other parts of a file specification (if present) into the equivalence file specification.

When you use a rooted-device logical name together with a directory specification, the following rules apply:

- You can refer to the root directory itself. The syntax of [000000] and relative directory references refer to the root directory.

You can never refer to a directory *above* the specified root directory because the root directory is the logical MFD whenever a directory specification is used. When the process-default directory is the root directory, a reference to [-] results in an error, as shown in the following example:

```
$ DEFINE/TRANSLATION ATTR=CONCEALED BASE DUA7:[ROOT1.]
$ SET DEFAULT BASE:[000000]
$ DIRECTORY *.DIR
```

The system responds to this command sequence with the following display:

```
BASE:[000000]
No files found
```

The user then tries to check the contents of the next higher directory with the following command:

```
$ DIRECTORY [-]*.DIR
```

The system responds with the following messages:

```
%DIRECT-E-OPENING, error opening [-]*.DIR as input
-RMS-E-DIR, error in directory name
```

- You can refer to a specific subdirectory of the root directory in the same way that you refer to a top-level directory using normal directory syntax, as shown in the following example:

```
$ DEFINE BASE DUA7:[ROOT1.]
$ SET DEFAULT BASE:[SUBDIR]
```

- You can refer to any subdirectory beneath the root directory using wildcard characters to vertically traverse the directory tree. You can refer to all directories below the root directory [...], all directories one level below the root directory [\*], all directories two levels below the root directory [\*.], and other reference combinations, as shown in the following example:

```
$ DEFINE/TRANSLATION ATTR=CONCEALED BASE DUA7:[ROOT1.]
$ DIR BASE:[*...]*.DIR
```

The system responds with the following display:

```
BASE:[SUBDIR]
    SUBSUBDIR.DIR
BASE:[SUBDIR.SUBSUBDIR]
    SUBSUBSUBDIR.DIR
BASE:[OTHERSUB]
```

## Advanced Use of File Specifications

### 6.3 Directory Syntax Conventions and Directory Concatenation

OTHERSUBSUB.DIR

With rooted-directory syntax, RMS uses the process-default device and directory *indirectly* as defaults. This occurs because RMS uses the expanded rooted-device logical name device and root directory before applying the process-default device and directory.

With rooted-directory syntax, you can use relative directory syntax, such as the hyphen (-) and leading period (.name). When a directory component is missing, RMS attempts to obtain the missing components from the process-default directory.

Consider the rooted-device logical name X defined as shown in the following DCL command:

```
$ DEFINE X DJB3:[SMITH.]
```

Now assume you set the default directory to JONES:

```
$ SET DEFAULT [JONES]
```

When the rooted-device logical name X is used with a directory specification, all directory references are relative to the root directory [SMITH.]. Most wildcard characters that apply to normal directory syntax also apply to rooted-directory syntax.

The following table lists the file specifications involving the rooted-device logical name X and the directory that is accessed with each specification:

| File Specification | Directories Accessed                                       |
|--------------------|--|
| X:                 | [SMITH.JONES]  |
| X:[000000]         | Root directory, [SMITH.]                                   |
| X:[]               | [SMITH.JONES]  |
| X:[]               | Root directory [SMITH.], listed as X:[000000]              |
| X:[- -]            | Invalid (error)  |
| X:[name]           | [SMITH.name]   |
| X:[.name]          | [SMITH.JONES.name]   |
| X:[name.*...]      | All directories in all directory trees below [SMITH.name]  |
| X:[*]              | All directories one level below [SMITH.]                   |
| X:[*...]           | All directories in all directory trees below [SMITH.]      |
| X:[...]            | All directories in all directory trees below [SMITH.JONES] |

Note that RMS uses the default directory with relative directory references when the specified directory name contains a leading period or a hyphen, or if no directory name is specified.

#### 6.3.5 An Example of Using a Rooted Directory

Consider an application made up of several programs that refer to the same file using a file specification IN:[INVENTORY]FILE.DAT. Assume that all of the programs invoke the following command procedure to define the logical name IN as device DUA29:

## Advanced Use of File Specifications

### 6.3 Directory Syntax Conventions and Directory Concatenation

```
$ ON CONTROL Y THEN GOTO ENDIT
$ DEFINE IN DUA29:
$ RUN XYZPROG
$ ENDIT:
$ EXIT
```

The programs show the current inventory level and the stockroom used for a particular item and are dispersed among many users in the company. As the business grows, the number of items in the inventory grows and the number of inventory records makes the file extremely large and difficult to access. Because the items can be classified as belonging to one of four groups, the data management department decides to split the file into four parts. A special-purpose program reads each record in the master file, determines the record type, and routes the record to the appropriate file group. All output files are named FILE.DAT, but each is distinguished by putting it in a top-level directory associated with the appropriate group category. For example, computer supplies files are cataloged in the directory [COMPUTER.INVENTORY].

This is done by modifying the command procedure to conditionally define the value of IN to be a rooted-device logical name with four subdirectories. The modified command procedure is shown in Example 6-1.

#### Example 6-1 Rooted-Directory Syntax

```
$ ON CONTROL Y THEN GOTO END
$ GOTO ASK
$ RETRY:
$ WRITE SYS$OUTPUT "Enter a number from 1 to 4 for the type of part"
$ ASK:
$ WRITE SYS$OUTPUT -
  "Select Parts Group: 1-COMPUTER 2-TYPEWRITER 3-DESK 4-OTHER 5-END"
$ INQUIRE ANS
$ IF ANS .GT. 5 .OR. ANS .LT. 1 THEN GOTO RETRY
$ IF ANS .EQ. 5 THEN EXIT
$ IF ANS .EQ. 1 THEN DEFINE/TRANS=CONCEAL IN DUA29:[COMPUTER.]
$ IF ANS .EQ. 2 THEN DEFINE/TRANS=CONCEAL IN DUA29:[TYPEWRITER.]
$ IF ANS .EQ. 3 THEN DEFINE/TRANS=CONCEAL IN DUA29:[DESK.]
$ IF ANS .EQ. 4 THEN DEFINE/TRANS=CONCEAL IN DUA29:[OTHER.]
$ RUN XYZPROG
$ END:
$ EXIT
```

With the enhanced command procedure, none of the programs has to be modified, recompiled (or reassembled), relinked, or copied to a different directory.

#### 6.3.6 Using a Rooted Directory to Extend RMS's Subdirectory Limit

On Alpha systems running OpenVMS versions prior to V7.2 and on VAX systems, RMS limits the number of subdirectory levels that can be accessed to eight.<sup>1</sup> Rooted directory syntax can be used to allow access to subdirectories up to fifteen levels below the volume's MFD. RMS allows up to seven levels in the root, with eight in the normal (non-root) directory.

<sup>1</sup> Alpha systems running OpenVMS versions V7.2 and later have a limit of 255 levels. DID abbreviation allows access to all subdirectories on a volume, regardless of "depth."

## Advanced Use of File Specifications

### 6.3 Directory Syntax Conventions and Directory Concatenation

You must access the files using rooted-directory syntax, whether or not a logical name is used for the rooted directory. For example, you can legally define the rooted-directory logical name MYROOT to be DUA0:[D1.D2.D3.D4.D5.D6.] and nest six subdirectories beneath it using the following directory syntax:

```
MYROOT:[D7.D8.D9.D10.D11.D12]
```

You can also refer to it as the following:

```
DUA0:[D1.D2.D3.D4.D5.D6.][D7.D8.D9.D10.D11.D12]
```

But if you try to access this file using the following directory syntax, RMS returns a status code that indicates that the file specification is illegal:

```
DUA0:[D1.D2.D3.D4.D5.D6.D7.D8.D9.D10.D11.D12]
```

---

#### Note

When you are choosing directory tree depths, remember that the Backup utility, as opposed to BACKUP/IMAGE or BACKUP/PHYSICAL, has depth limits when it is doing file backups. See *OpenVMS System Manager's Manual, Volume 1: Essentials*, and *OpenVMS System Management Utilities Reference Manual: A-L* for information about using the Backup utility.

---

### 6.4 DID-Abbreviated Directories (Alpha Only)

To support Extended File Specifications, RMS's user interface was extended to include capacities for the larger specifications that are sometimes necessary to access ODS-5-named files. (See the *OpenVMS Record Management Services Reference Manual*.) To take full advantage of all of the new features, applications would have to be updated to use the interface extensions. To provide extended capabilities (such as access to deep directories) to applications that continue to use the older interface, RMS supports the generation and acceptance of file specifications with an abbreviated form of root or directory specification, known as a DID (for Directory ID) abbreviation.

---

#### Note

The DID abbreviation is used in file specifications and should not be confused with the numeric DID field of the NAM block.

---

The DID is an alternate form of subdirectory specification that is not relative to the MFD. It takes the form (for ODS-2 and ODS-5 disks) of three decimal numbers separated by commas and can be used in the MFD position in a root or directory component specification.

Examples of valid root and directory components with DIDs are as follow:

```
DKA200:[24,42,0]
DKA200:[1223,4,0.a]
DKA200:[134,59,0...]
DKA200:[1223,4,0.][134,59,0]
```

## Advanced Use of File Specifications

### 6.4 DID-Abbreviated Directories (Alpha Only)

A DID can also be used in place of a subdirectory in a root or directory component, but subdirectories located to its left in the specification (above it in the directory tree) are elided by RMS, as shown in the following example:

```
$SET PROCESS/PARSE STYLE=EXTENDED
$WRITE SYS$OUTPUT F$PARSE("DKA200:[system.test.134,59,0...]*.*;*" )
DKA200:[134,59,0...]*.*;*

$WRITE SYS$OUTPUT F$PARSE("DKA200:[system.test.134,59,0.BTEST2]*.*;*" )
DKA200:[134,59,0.BTEST2]*.*;*
```

If a specification contains both a root with a DID and a directory with a DID, the root will be ignored (though not elided) by RMS.

The directory ID numbers are those that are displayed for a directory with the DIRECTORY/FILE\_ID DCL command, as shown in the following:

```
$DIRECTORY/FILE_ID/NOHEADER/NOTRAILING/WIDTH=(FILE=45) .DIR;1
DKA200:[SYSTEM]1.DIR;1          (24,42,0)
DKA200:[SYSTEM]a.DIR;1         (1223,4,0)
DKA200:[SYSTEM]BTEST1.DIR;1    (134,59,0)
DKA200:[SYSTEM]DIR^_1.DIR;1    (609,22,0)
DKA200:[SYSTEM]lowercase.DIR;1 (655,49,0)
DKA200:[SYSTEM]te^[mp.DIR;1    (20,37,0)
DKA200:[SYSTEM]tmp^.tmp.DIR;1  (355,20,0)
DKA200:[SYSTEM]UNICODE.DIR;1   (1968,10,0)
DKA200:[SYSTEM]UPPERCASE.DIR;1 (656,45,0)
DKA200:[SYSTEM]with^.dot.DIR;1 (768,28,0)
```

When RMS attempts to generate a file specification that is too long for the application's output buffer, pointed to by the NAM block expanded or resultant string field, NAM\$L\_ESA or NAM\$L\_RSA; or by the NAML block short expanded or short resultant string file, NAML\$L\_ESA or NAML\$L\_RSA, it replaces the root and directory component with one that has the DID for the lowest level subdirectory of the replaced component(s). The specification that results can then be used as input to RMS.

It should be noted that not all RMS features are available with DIDs. For example, attempts to use sticky defaulting with a root or directory with a DID will result in an error. And you cannot create a directory using a DID.

### 6.5 FID-Abbreviated Names (Alpha Only)

On Alpha systems, when a file specification, even with DID abbreviation, is too long to fit into a resultant name buffer (NAM block NAM\$L\_RSA field or NAML block NAML\$L\_RSA field), RMS attempts to generate a short-enough file specification by identifying the file with its file ID (three decimal numbers separated by commas, surrounded by brackets) in the file name component.

In cases in which the file type component would otherwise be presented, a generated file specification will either include the entire type or will not include any type (including the "." delimiter), depending upon whether or not there is space.

In cases in which the version component would otherwise be presented, a generated file specification will include the version component.

As a human-readable aid in recognizing files, when a FID is generated, the name component also contains a DCL-legal initial subset of the actual file name. The subset consists of the first 38 simple characters (where "^U1234" is six simple characters) of the actual file name, followed by "~".

## Advanced Use of File Specifications

### 6.5 FID-Abbreviated Names (Alpha Only)

No attempt is made to resolve ambiguities for files that differ only after the first 38 simple characters of their names.

An example of a generated name with a FID is as follows:

```
DKA200:[SYSTEM]leadingfilenamechars~[384,35200,0].txt;1
```

Such a file specification can be used as input to RMS, with some limitations.

#### 6.5.1 Restrictions on FID-Abbreviated Names

A FID can be used for input to RMS, but only the FID is significant. The subset portion of the name component, the type component, and the version component are ignored by RMS.

As input, the FID-abbreviated file name component is not used as a default (as from a related file specification to replace a wildcard in an output specification). Instead, the output specification will get a null file name, as shown in the following:

```
$COPY/LOG ^U6666^U7777^U8888^U9999^U5555^U6666~[449,35295,0].txt;1 *.xxx
%COPY-S-COPIED, DKA200:[SYSTEM]^U6666^U7777^U8888^U9999^U5555^U6666~
[449,35295,0].txt;1 copied to DKA200:[SYSTEM].xxx;1
```

Note that generated names with FIDs are possible only for resultant specifications, which refer to specific files, and not for expanded specifications, which do not necessarily refer to one file.

## 6.6 Using Process-Permanent Files

Process-permanent files are files that remain open independent of image activation and rundown. Process-permanent files are created by setting the process-permanent file bit (FAB\$V\_PPF) in the file-processing options field (FAB\$L\_FOP). When the bit is set, RMS-maintained internal data structures are allocated in the process control region of memory for the life of the process. Thus, process-permanent files can remain open across image activations. SYS\$COMMAND, SYS\$INPUT, SYS\$OUTPUT, and SYS\$ERROR are all opened in this manner by the LOGINOUT command image.

The DCL command OPEN also opens files in this manner. With user mode code, you can access process-permanent files only indirectly. RMS provides a subset of the total available operations to the indirect accessor.

Indirect accessors gain access to process-permanent files through the logical name mechanism, as follows:

1. The LOGINOUT command image, or at a later point the command interpreter, opens or creates a file corresponding to the process's command, input, output, and error message streams. Logical names are created in the process logical name table for SYS\$COMMAND, SYS\$INPUT, SYS\$OUTPUT, and SYS\$ERROR, respectively. The equivalence string for the logical name has a special format that indicates the correspondence between the logical name and the related process-permanent file. For more detail concerning the equivalence-string format for logical names, see the discussion of logical name services in the *OpenVMS System Services Reference Manual*. For example, for an interactive user, these single process-permanent files are opened for the terminal.

## Advanced Use of File Specifications

### 6.6 Using Process-Permanent Files

2. When an indirect accessor opens or creates a file specifying a logical name that has one of these special equivalence strings, RMS recognizes this and therefore does not open or create a new file. Instead, the returned value for the internal file identifier (and later the value for the internal stream identifier from a Connect service) is set to indicate that access to the associated process-permanent file is with the indirect subset of allowable functions.

The implications for the indirect accessor are described in the following list:

- A Create service for a process-permanent file becomes an Open service; the fields of the FAB are output according to the description of the Open service, not the Create service.
- The Open and Create services require no I/O operations.
- Any number of indirect Open and Create operations are allowed.
- There is only one position context for the file; each sequence of the Open or Create service accesses the same record stream, not an independent stream.
- If the process-permanent file was initially opened with the sequential-processing-only (FAB\$V\_SQO) bit set in the FAB\$L\_FOP field, neither random access nor the Rewind service is permitted. This is the case for SYS\$COMMAND, SYS\$INPUT, SYS\$OUTPUT, and SYS\$ERROR.
- Certain options to various services produce errors. For example, you cannot set the non-file-structured (FAB\$V\_NFS), process-permanent file (FAB\$V\_PPF), and user-file-open (FAB\$V\_UFO) bits of the FAB\$L\_FOP field for the Open and Create services. Other options are ignored, such as: the spool (FAB\$V\_SPL), submit-command-file (FAB\$V\_SCF), delete (FAB\$V\_DLT) bits of the FAB\$L\_FOP field for the Close service; the asynchronous (RAB\$V\_ASY) bit of the RAB\$L\_ROP field; the multiblock count field (RAB\$B\_MBC) and the multibuffer count field (RAB\$B\_MBF; or optionally, the XAB\$\_MULTIBUFFER\_COUNT XABITM).
- If a name block is used and either an expanded or resultant file specification string is returned, the string consists solely of the process logical name followed by a colon (such as SYS\$INPUT:).
- The file access (FAB\$B\_FAC) field is ignored by the Open service; instead, operations are checked against the FAB\$B\_FAC field specified for the original Open or Create service.
- Information from the record attributes field is saved on each Open service and subsequent Connect service in the values returned in the internal file identifier and internal stream identifier fields. If the output file is a print file (VFC record format and the FAB\$V\_PRN bit set in the record attributes field), mapping is performed for each Put service from the user-specified carriage control to the print file carriage control format. Thus, different carriage control types from different indirect Open services all work correctly.
- You cannot use the Erase service.
- Checking is performed for \$DECK, \$EOD, and other dollar-sign (\$) records on the SYS\$INPUT stream if the SYS\$INPUT stream is from a file. Checking is not done if SYS\$INPUT comes from a record-oriented device, such as a terminal or a mailbox. (See the *OpenVMS DCL Dictionary*.)
- At image exit time, the run-down control routine ensures that the indirect I/O on process-permanent files terminates; however, these files are not closed.

## Advanced Use of File Specifications

### 6.6 Using Process-Permanent Files

- All file organizations may be opened directly as process-permanent files (for example, through the DCL command OPEN), but only those files with a sequential organization may be indirectly accessed.



---

## File Sharing and Buffering

This chapter discusses the run-time options that are available when opening, connecting, and closing a shared file. These options are implicit in creating a shared file because the Create service includes an implied file open.

File sharing includes file accessing, record locking, and local and shared buffering. Figure 7–1 shows a typical shared file situation.

**Figure 7–1 Shared File Access**

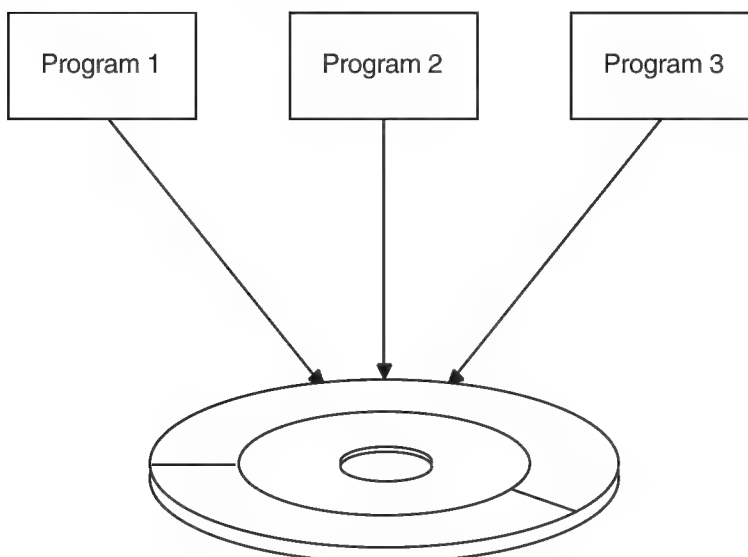

ZK-0757-GE

See the *OpenVMS Record Management Services Reference Manual* for more information about accessing and sharing files.

### 7.1 File Accessing

OpenVMS RMS (hereafter referred to as RMS) file sharing allows multiple users to access a single file. Timely access to files sometimes requires that more than one active program be allowed to read, write, and modify records within the same file simultaneously.

Whether or not a file can be shared depends on the type of device it resides on and the explicit file-sharing information specified by the processes that access the file. Magnetic tape files cannot be shared because magnetic tape drives are sequentially operated devices. However, disk files can be shared by any combination of readers and writers without restriction. Your program provides the information that enables file sharing. You control the degree of sharing

## File Sharing and Buffering

### 7.1 File Accessing

by providing an explicit file-sharing specification when your program opens or creates a file. This specification indicates the types of file operations that are permitted for application programs that share the file.

When a program creates or opens a disk file, it gives two pieces of information needed to determine if and how the file may be shared. First, it states the types of operations it intends to perform on the file, such as read, write, or update. RMS later checks this information to protect against unauthorized file access.

Second, the program specifies the types of operations other concurrently active programs can perform on the file. When the sharing specification of one program is compatible with the sharing specification of another, both programs can gain access to the file simultaneously. To ensure that multiple programs can access the file simultaneously, you may have to do some schedule planning.

#### 7.1.1 Types of File Sharing and Record Streams

A single process can access the same file using multiple **record streams**. A record stream is the access environment in which file records may be read, written, deleted, or updated. Important elements of the access environment are the current record position (if any), the access mode established for the current record, the sequential next record position, and the state of locks on other records in the file.

The Connect service creates a record stream and associates it with a file opened or created by the appropriate service. The connection between a record stream and a file is explicitly terminated by the Disconnect service or is implicitly terminated by closing the file. Record streams are connected to a file in one of three ways:

- Within one process or across several processes, multiple FABs can be connected to a shared file. One or more record streams may then be connected to each FAB. This form of sharing is known as **interlocked interprocess file sharing** and is associated with reading or writing records, not blocks.
- Within one process, multiple record streams can be associated with one FAB to read and write records, not blocks. This form of sharing is known as **multistreaming**.
- Within one process or across several processes, multiple FABs can be connected to a file. One record stream (RAB) is connected to each FAB, and users provide their own synchronization. This form of file sharing is known as **user-interlocked interprocess file sharing**. (User-interlocked interprocess file sharing usually applies only to block I/O processing and to record processing for nonshared sequential files residing on disk devices.)

Two important options for shared files are the file-access and file-sharing options. These options specify the type of record access that the sharing processes can perform. They are specified by the FDL attributes ACCESS and SHARING and the FAB fields identified by the symbolic offsets FAB\$B\_FAC and FAB\$B\_SHR. When creating or opening a file, RMS compares the values of these fields to determine whether or not the requesting process may have access to the file.

In this manual, the term **accessor** refers either to a process that accesses a file or a record stream that accesses a record. The first process to access a file determines which operations other accessors can perform on the file, which in practice determines whether or not subsequent users are allowed to access the file. For example, if your process requests a certain type of access that the first

accessor (since the file was last closed) has disallowed, your process cannot access the file.

When choosing the access other processes may have to the file, you can specify the type of file sharing to be used and indicate whether or not other processors can access the file simultaneously.

In an OpenVMS Cluster environment, processes can access shared files on the same or different nodes. (See Section 3.7).

A single file can be accessed by both interlocked interprocess file sharing and multistreaming. Compaq does not recommend the simultaneous use of interlocked interprocess file sharing and user-interlocked interprocess file sharing on the same file if the process that requests user-interlocked interprocess file sharing intends to modify the file. The reason is that record locking is not done or checked for the processes using user-interlocked interprocess file sharing.

You must define your process access based on planned record operations. The record operations with associated FDL and RMS options are summarized in Table 7-1.

**Table 7-1 File Access Record Operations**

| Function (Service)       | FDL and RMS Options   |
|--------------------------|---|
| Read records (Get)       | ACCESS GET specified or FAB\$B_FAC field FAB\$V_GET set   |
| Locate records (Find)    | ACCESS GET specified or FAB\$B_FAC field FAB\$V_GET set   |
| Delete records (Delete)  | ACCESS DELETE specified or FAB\$B_FAC field FAB\$V_DEL set  |
| Add new records (Put)    | ACCESS PUT specified or FAB\$B_FAC field FAB\$V_PUT set   |
| Truncate file (Truncate) | ACCESS TRUNCATE specified or FAB\$B_FAC field FAB\$V_TRN set  |
| Modify records (Update)  | ACCESS UPDATE specified or FAB\$B_FAC field FAB\$V_UPD set  |
| Access blocks (see text) | ACCESS BLOCK_IO specified or FAB\$B_FAC field FAB\$V_BIO set; under certain conditions, ACCESS RECORD_IO or FAB\$B_FAC FAB\$V_BRO |

The record-access functions you request are compared with the protection on the specified file. If your process is limited to reading and locating records, it should have read access to the file. If your process is deleting, adding, truncating, or updating records, it must have write access to the file. RMS permits any process that may delete, add, truncate, or modify records to also locate and read records because write access to a file also implies read access.

You can perform block I/O operations using the Read, Space, and Write services. Block I/O is usually only used by applications written in VAX MACRO or other low-level languages. Note that when ACCESS BLOCK\_IO is specified, the application program must also specify either SHARING USER\_INTERLOCK or SHARING PROHIBIT.

## File Sharing and Buffering

### 7.1 File Accessing

Different types of record operations can be specified to define the type of access to be allowed for other processes, as shown in Table 7–2.

**Table 7–2 File-Sharing Record Operations**

| Function (Service)      | FDL and RMS Options   |
|-------------------------|---|
| Read records (Get)      | SHARING GET specified or FAB\$B_SHR field<br>FAB\$V_SHRGET set    |
| Locate records (Find)   | SHARING GET specified or FAB\$B_SHR field<br>FAB\$V_SHRGET set    |
| Delete records (Delete) | SHARING DELETE specified or FAB\$B_SHR field<br>FAB\$V_SHRDEL set |
| Add new records (Put)   | SHARING PUT specified or FAB\$B_SHR field<br>FAB\$V_SHRPUT set    |
| Modify records (Update) | SHARING UPDATE specified or FAB\$B_FAC field<br>FAB\$V_SHRUPD set |
| No access               | SHARING PROHIBIT or FAB\$B_SHR field FAB\$V_<br>NIL set           |
| User interlocking       | SHARING USER_INTERLOCK or FAB\$B_SHR field<br>FAB\$V_UPI set      |
| Multistreaming          | SHARING MULTISTREAM or FAB\$B_SHR field<br>FAB\$V_MSE set         |

If other processes are limited to reading and locating records, they are unable to modify or add records, and record-lock checking is not performed. If other processes are allowed to delete, add, or modify records, they can also read records; however, record-lock checking occurs. All record-access functions use interlocked interprocess file sharing.

*No access* denies access to all accessors except the accessor who specifies the option. This option might be used when a file is shared infrequently or when doing a major update. When you use this option, be sure to close the file promptly when other users are trying to access the file. Choose this option or the user-interlocking option when using block access. To use the Queue I/O Request system service, specify the FILE USER\_FILE\_OPEN attribute (FAB\$L\_FOP field FAB\$V\_UFO set). The no-access option does not allow file sharing and requires that your process have write file protection access.

*User interlocking* permits the user to maintain interlocking protection (including maintaining the end-of-file mark). For any other form of file sharing, RMS controls the reading and writing of I/O buffers to ensure the integrity of file and record structures. This option is useful for nonshared sequential files and for block I/O access using RMS or the Queue I/O Request system service.

*Multistreaming* allows your process to access the same file using more than one record stream and allows other users to access the file using interlocked interprocess file sharing (unless SHARING PROHIBIT is also specified). When you select this option, select the appropriate SHARING record operations, such as SHARING GET. When multiple streams are connected, the buffers allocated for each stream become part of a buffer cache for the entire process. (A buffer cache is a common shared buffer pool intended to minimize I/O.) A record operation on one stream may use cached buffers from a previous record operation on a different stream that referenced the same buckets.

When you open or create a file, you must specify the file access and file sharing you want for it. When using FDL or RMS, the default is to read records from the file (ACCESS GET) and to allow others accessors to read records from the file (SHARING GET). Typically, an application program may want to read records (ACCESS GET) while allowing other accessors to add records (SHARING PUT). You might want to modify records (ACCESS UPDATE) while allowing other accessors to add new records to the file (SHARING PUT).

When you create a file, the default is for FDL and RMS to add records to the file (ACCESS PUT) and to not allow others to access the file (SHARING NONE). When you create a file with the create-if option, it is especially important to specify the access and sharing values. In this instance, you have denied yourself access if the file already exists because you have specified SHARING NONE and you are not the initial accessor. One way to avoid this when you create a file is to allow most operations for other users (such as SHARING GET, SHARING PUT, SHARING UPDATE, and SHARING DELETE).

Combinations of file access and file sharing that specify a mixture of interlocked interprocess file access and user-interlocked interprocess file sharing allow the application program to access the file without record locking protection. Such combinations are not recommended for general use; they should be used only for application programs that require read-only access to a file. Other combinations may cause an error, such as requesting ACCESS BLOCK\_IO without specifying SHARING NONE or SHARING USER\_INTERLOCK.

### **7.1.2 Interlocked Interprocess File Sharing**

Interlocked interprocess is the most common form of file sharing. This method allows the connection of one or more record streams (RABs) to one or more processes (FABs), either within a single process or across several processes. When using this form of file sharing, the values specified for file sharing and file access by the initial accessor determine the type of access permitted for subsequent processes.

The initial accessor must consider the restrictions that result from the values specified for file sharing and file access. Typically, the initial accessor denies all write access to subsequent processes. Such a restriction occurs when the initial accessor specifies some type of write access for file access without specifying write access for file sharing.

If the initial accessor specifies read-only file access and file sharing, subsequent accessors can only read the file. If the appropriate type of write access is not specified, then subsequent accessors cannot perform the corresponding write operations to the file.

If the initial accessor specifies one or more values for file sharing, subsequent processes can access the file if they specify compatible file access values. For example, if the initial accessor specifies SHARING GET and SHARING PUT, subsequent accessors must specify ACCESS GET to read the file, and ACCESS PUT to write new records to the file (read access is implied by all four types of write access).

Table 7-3 presents the values that the initial accessor of a file can specify for file sharing to permit access to subsequent accessors.

## File Sharing and Buffering

### 7.1 File Accessing

**Table 7–3 Initial File Sharing and Subsequent File Access**

| Initial Accessor Sharing | Subsequent Accessor Access |
|--------------------------|----------------------------|
| SHARING PROHIBIT         | No access allowed          |
| SHARING GET <sup>1</sup> | ACCESS GET <sup>1</sup>    |
| SHARING DELETE           | ACCESS DELETE              |
| SHARING PUT              | ACCESS PUT                 |
| SHARING UPDATE           | ACCESS UPDATE              |

<sup>1</sup>Implied related operation

Because the initial accessor can specify multiple SHARING values, a subsequent accessor whose ACCESS values match one, some, or all of the initial accessor's SHARING values is allowed access; however, when the subsequent accessor specifies an ACCESS value that the initial accessor did not specify as a SHARING value (an exception is SHARING GET, which is implied), access is denied to the subsequent accessor.

In addition to comparing the file access values that subsequent accessors specify with the file-sharing values specified by the initial accessor, the values that subsequent accessors specify must be compatible with values specified by the initial accessor. Table 7–4 shows the file-sharing values that subsequent accessors must specify to access the file.

**Table 7–4 Initial File Access and Subsequent File Sharing**

| Initial Accessor Access | Subsequent Accessor Sharing |
|-------------------------|-----------------------------|
| ACCESS GET <sup>1</sup> | SHARING GET <sup>1</sup>    |
| ACCESS DELETE           | SHARING DELETE              |
| ACCESS PUT              | SHARING PUT                 |
| ACCESS UPDATE           | SHARING UPDATE              |

<sup>1</sup>May be implied a related operation

Because the initial accessor can specify multiple ACCESS values, a subsequent accessor whose SHARING values match all of the initial accessor's ACCESS values is allowed access; however, when the subsequent accessor specifies a SHARING value that the initial accessor did not specify as an ACCESS value (an exception is ACCESS GET, which is implied), access is denied.

#### 7.1.3 User-Interlocked Interprocess File Sharing

User-interlocked interprocess file sharing allows one or more application programs to write records to a sequential file residing on a disk device or to a file on a disk device that is open for block I/O processing. It cannot be used with relative and indexed files opened for record access. (For record access to relative and indexed files, RMS transparently controls the reading and writing of buffers to the file and always maintains current end-of-file information.)

All sequential files that reside on disk devices may be write shared with user-provided interlocks. To use this feature, you must specify SHARING USER\_INTERLOCK (set the FAB\$B\_SHR field FAB\$V\_UPI bit). Note that when this option is specified, RMS does not attempt to control the reading and writing of I/O

buffers across processes, nor does it maintain end-of-file information. Thus, you must use the Flush service (or language equivalent, if any) to force the writing of modified I/O buffers and to rewrite the record attributes (including end-of-file information) in the file header. Processes that open the file after that point obtain the new end-of-file information. Note also that record attributes are rewritten whenever a file is closed. The last write accessor to close the file must also be the last accessor to have extended the file. If not, end-of-file information is written by another write accessor. Read accessors of a shared sequential file can update their internal end-of-file context by closing and reopening the file.

No form of record locking is supported for this type of file sharing. Although record locking is not checked using user-interlocked interprocess file sharing, file locking is checked. For instance, if you or another user specify SHARING NONE, one of you may be denied access.

If a process tries to implement the truncate service when closing a *sequential* file, it must have sole *write access* to the file. If other processes have *write access* to the file, RMS does not close it and it remains accessible to other processes. If other processes have the file open for *read access*, RMS defers the truncation until the final process having *read access* closes the file.

Similarly, if a process tries to implement the truncate-on-put option when inserting a record into a *sequential* file, it must have sole access to the file. If other processes have access to the file, RMS does not insert the record.

## 7.2 Record Locking

Synchronized access to records is required in a shared file environment where record streams may compete for access to records. The operating system implements synchronized access using record locking. That is, record access conflicts are resolved by locking the record until the final competing record stream processes the record. This ensures that a program may add, delete, or modify records without interference and that when a record operation is finished, the data is consistent.

---

### Note

---

On VAX systems, RMS record locking differs from RMS Journaling for OpenVMS record locking. If your application program uses Recovery Unit Journaling, see the *RMS Journaling for OpenVMS Manual* for details.

---

The operating system allows you to determine whether the application program or RMS provides record locking. Processes accessing the file make this choice by specifying appropriate sharing attributes and access attributes in the FAB as described in Section 7.1. In general, RMS enables record locking when record modifications are permitted in a shared file environment.

RMS provides record locking for all file organizations and uses the lock manager to keep conflicting record streams from updating a record simultaneously. The rest of this section describes record locking.

## File Sharing and Buffering

### 7.2 Record Locking

#### 7.2.1 Default Record Locking

You can specify various record-locking options in the RAB when you access a record by way of a record stream. If you do not explicitly specify any record-locking options when you access a record, RMS uses default record locking to automatically and transparently lock and unlock shared records. Default record locking does not require special handling of locks in the application program.

In a typical record-locking scenario, an application program calls a service to access and lock a record. The application program then processes the locked record. When it finishes processing the record, the application program calls the appropriate service to finish processing and unlock the record.

The following scenario illustrates processing an existing record:

1. The application program invokes the Get service to access the record, lock the record for exclusive access, and return the record to the application program.
2. The application program modifies the locked record. Other record streams that try to access the record using default record locking get a record-locked error. This prevents the locked record from being accessed and modified before the application program finishes modifying it.
3. The application program invokes the Update service to store the modified record in the file and remove the lock on the modified record, thereby making the record available to other record streams.

When RMS provides record locking, the Get, Find, and Put services apply locks. The Get service and the Find service normally return with a record locked, but the Put service returns with the record unlocked unless you specify the manual-unlocking option.

When the application program uses default record locking, RMS automatically unlocks the locked record when one of the following events occurs:

- Another record is accessed (Get service and Find service).
- The current record is updated (Update service).
- The current record is deleted (Delete service).
- The record stream is disconnected (Disconnect service).
- The file is closed (Close service).
- The record stream is positioned to the beginning of the file (Rewind service).
- A new record is added to the file (Put service).
- The record lock is explicitly removed (Release service or Free service).
- An error occurs during a record operation.

Note that a sequential Get service immediately following a Find service does not unlock the record because it accesses the same record.

#### 7.2.2 Record-Locking Options

Record-locking options can be divided into three groups:

- Options that specify the access allowed by other record streams
- Options that control record conflicts between record streams
- Miscellaneous options

All record-locking options are specified by RAB input to the accessing service. All record-locking options apply to the Get service and the Find service, and most record-locking options apply to the Put service. You can specify a different set of record-locking options each time the record stream accesses a record.

This section describes the types of record access allowed by each record locking option. It also provides some examples of when an application program might select a particular record-locking option. The following five record-locking options control record access by other record streams:

- Exclusive locking
- Write locking
- Read locking
- No locking
- No query locking

To update or delete a record, a record stream must have an exclusive lock or a write lock on the record.

#### 7.2.2.1 Exclusive Locking

By default, RMS performs exclusive locking. With exclusive locking, only the initial record stream is permitted to access the record for reading or writing until the lock is released. Any other record stream that tries to read or write the record by applying a lock is denied access. When a record stream is denied access because of a locked record, the requesting service returns a locked-record status (RMS\$\_RLK).

A record stream can read an exclusively locked record only with the read-regardless option (see Section 7.2.3.3).

Most application programs use exclusive locking because it requires minimal programming and provides maximum protection when modifying and reading records. Note, however, that contention is apt to be greatest when a record stream uses the exclusive-locking option.

See Section 7.2.1 for an example of how RMS uses exclusive locking for an application program that is modifying a record.

#### 7.2.2.2 Write Locking

The write-locking option allows the record stream that locks a record to modify the record. This option prohibits other record streams from having write-lock access or exclusive lock access, both of which imply an intent to modify the record. The write-locking option also denies read-lock access to other record streams because a read-lock access is incompatible with a record stream that is modifying the record.

Contending record streams can read the record using the no-locking option, or the read-regardless option (see Section 7.2.3.3). When a contending record stream reads a write-locked record using the no-locking option, the accessing service returns a success status.

Typically, an application program uses the write-locking option when it wants the record to remain in a consistent state while the application program is modifying the record.

## File Sharing and Buffering

### 7.2 Record Locking

#### 7.2.2.3 Read Locking

The read-locking option permits other record streams to access the record for reading but denies access to any record stream that attempts to access the record for making modifications.

No record stream is allowed to access a read-locked record for making modifications to the record until all record streams that have a read lock release the record. Any record stream that attempts to access a read-locked record using either the exclusive-locking option or the write-locking option are denied access. The requesting service returns a completion status record to the application program indicating that the record was locked (RMS\$\_RLK) and the requesting record stream was denied access.

Contending record streams can read the record using the read-locking option, the no-locking option or the read-regardless option (see Section 7.2.3.3). When a contending record stream accesses a read-locked record using the read-locking option or the no-locking option, the accessing service returns a success status.

Typically, an application program uses the read-locking option when it wants the record to remain in a consistent state while reading the record but does not intend to modify the record.

#### 7.2.2.4 No Locking (Query Locking)

The no-locking option specifies that the requesting record stream does not want to lock the record. This locking option permits the requesting record stream to have access to all locked records except for records that are locked for exclusive access. It also permits other record streams to apply any type of lock to the record. Using this option minimizes contention, but unlike the no query record locking option does not avoid a call to the lock manager .

By implication, a record stream that uses the no-locking option can only access the record for reading. When a record stream uses the no-locking option to access a record, the invoked service returns with the record unlocked.

Note that when a record stream selects the no-locking option, RMS momentarily locks the record to query whether or not the record is already locked by another record stream. This is required in order to determine if access is allowed. If the record is not locked, the requesting service returns a completion status indicating a successful access. If the record has an exclusive lock, the access is denied and the requesting service returns a completion status indicating the record is locked (RMS\$\_RLK). If the record has a write lock, the requesting service reads the record and returns a completion status indicating that the record was locked but a read was permitted (RMS\$\_OK\_RLK).

If you specify the no-locking option together with the manual-unlocking option, the no-locking option takes precedence. That is, if you specify both options to the service that accesses the record, the service returns control to the application program with the record unlocked. See Section 7.2.4.1 for a description of the manual-unlocking option.

#### 7.2.2.5 No Query Record Locking Option (Alpha Only)

The OpenVMS operating system provides functionality that can minimize record locking for read accesses to shared files, thereby avoiding the processing associated with record locking calls to the lock manager.

In previous releases to OpenVMS Version 7.2-1H1, if a file is opened allowing write sharing, an exclusive record lock is taken out for all record operations (both read and write). Applications may obtain record locking modes other than the exclusive lock (default) by specifying certain options to the RAB\$L\_ROP field. However, all the options involve some level of record locking. That is, the options require \$ENQ or \$DEQ system service calls to the lock manager.

The user record locking options include the RAB\$V\_NLK (no lock) query locking option, which requests that RMS take out a lock to probe for status and not hold the lock for synchronization. If the lock is not granted (exclusive lock held) and the read-regardless (RAB\$V\_RRL) option is not set, the record access fails with an RMS\$\_RLK status. Otherwise, the record is returned with one of the following statuses:

- RMS\$\_SUC — No other writers
- RMS\$\_OK\_RLK — Record can be read but not written
- RMS\$\_OK\_RRL — Exclusive lock is held (lock request denied) but the read-regardless (RAB\$V\_RRL) option is set

When only the RAB\$V\_NLK option is specified, record access can be denied. When both the RAB\$V\_NLK and RAB\$V\_RRL options are specified, an application can guarantee the return of any record with a success or alternate success status.

The OpenVMS Version 7.2-1H1 introduces the **no query record locking option**, which allows applications to read records (using \$GET or \$FIND services) without any consideration of record locking. This option:

- Does not make a call to the lock manager
- Is equivalent to both RAB\$V\_NLK and RAB\$V\_RRL being set except that the RMS\$\_OK\_RLK or RMS\$\_OK\_RRL status will not be returned

This functionality applies to all three file organizations (sequential, relative, and indexed).

Three alternate methods for specifying the no query record locking option are outlined in Table 7-5.

Note the following:

- The first method allows the option to be enabled externally, potentially without any application change.
- You should use any of the methods only as appropriate for the application. In particular, you should check for any dependency in an existing application on the alternate success status RMS\$\_OK\_RLK or RMS\$\_OK\_RRL.

## File Sharing and Buffering

### 7.2 Record Locking

**Table 7–5 Methods Available for Specifying No Query Record Locking**

| To...  | Use This Method...  |
|--|---|
| Disable query record locking at the process or system level.   | <p>Enter the following DCL command to request the RMS use no query record locking for any read operation with both RAB\$V_NLK and RAB\$V_RRL options set in the RAB\$L_ROP field:</p> <pre>\$ SET RMS_DEFAULT/QUERY_LOCKING=DISABLE[/SYSTEM]</pre> <p>Keys on RAB\$V_NLK and RAB\$V_RRL options in existing applications.</p>   |
| Enable no query record locking on a per-record read operation. | <p>Set the RAB\$V_NQL option in the RAB\$W_ROP_2 field.</p> <p>The RAB\$V_NQL option takes precedence over all other record locking options. Use only if the current read (\$GET or \$FIND) operation is not followed by an \$UPDATE or \$DELETE call.</p>  |
| Enable no query record locking at the file level.              | <p>Set the FAB\$V_NQL option in the FAB\$B_SHR field to request that RMS use no query locking for the entire period the file is open for any read record operation with both RAB\$V_NLK and RAB\$V_RRL options set in the RAB\$L_ROP field.</p> <p>This option can be used with any combination of the other available FAB\$B_SHR sharing options. Keys on RAB\$V_NLK and RAB\$V_RRL options in applications.</p> |

RMS precedence for the no query record locking option is as follows:

- The RAB\$V\_NQL option set in the RAB\$W\_ROP\_2 field
- At file open (and applied, if RAB\$V\_NLK and RAB\$V\_RRL are set for the read operation):
  - The FAB\$V\_NQL option set in the FAB\$B\_SHR field
  - The SET RMS\_DEFAULT/QUERY\_LOCKING=DISABLE setting at the process level
  - The SET RMS\_DEFAULT/QUERY\_LOCKING=DISABLE setting at the system level. If the process /QUERY\_LOCKING setting equals SYSTEM\_DEFAULT (the default when the process is created), RMS uses the system specified value.

#### 7.2.2.6 Put Service Considerations

Because the Put service adds a new record, the application program does not have to access an existing record. However, because adding a record is a multistep process, the record that is being added must be locked until the entire process is finished.

The scenario for adding a record to a file begins with the application program moving a record into its buffer. Next, the application program calls the Put service, which locks the record while it moves it from the application program buffer to the file. When the record is in the file, the Put service unlocks the record, making it available to other record streams. The locking process is transparent at the program level unless the application program selects the manual-unlocking option.

If a record stream tries to add a record using the no-locking option, the Put service ignores the option and adds the record.

**7.2.2.7 Summary**

This section provides two tables to summarize the information described in Sections 7.2.2.1 through 7.2.2.6.

The record-locking options that control record access exhibit varying degrees of compatibility. Table 7–6 summarizes access control locking compatibility by comparing the type of access being requested by a record stream with the current lock held by another record stream. The table does not take into account miscellaneous record-locking options, notably the read-regardless option.

**Table 7–6 Compatibility of Record-Locking Options**

| Requested Access | Current Lock Held by Another Record Stream |                  |                  |      |
|------------------|--|------------------|------------------|------|
|                  | EXCLUSIVE                                  | WRITE            | READ             | None |
| EXCLUSIVE        | NO   | NO               | NO               | YES  |
| WRITE            | NO   | NO               | NO               | YES  |
| READ             | NO   | NO               | YES              | YES  |
| NO LOCK          | NO   | YES <sup>1</sup> | YES <sup>1</sup> | YES  |

<sup>1</sup>RMS\$\_OK\_RLK is returned.

The next table lists record-locking options that control record access and how you select each option through the FDL and RMS interfaces.

| Option            | Interface    | How to Select  |
|-------------------|--------------|--|
| Exclusive locking | FDL:<br>RMS: | This is the default when you do not select write locking, read locking, or no locking. |
| Write locking     | FDL:<br>RMS: | CONNECT LOCK_ON_WRITE<br>RAB\$L_ROP RAB\$V_RLK   |
| Read locking      | FDL:<br>RMS: | CONNECT LOCK_ON_READ<br>RAB\$L_ROP RAB\$V_REA  |
| No locking        | FDL:<br>RMS: | CONNECT NOLOCK<br>RAB\$L_ROP RAB\$V_NLK  |

**7.2.3 Handling Record-Locking Conflicts**

Application programs that use shared files must handle record locking conflicts that may occur when two or more record streams try to access the same record.

## File Sharing and Buffering

### 7.2 Record Locking

RMS provides three options for handling record locking conflicts:

- You can have the application program handle the record-locked error status (RMS\$\_RLK) returned by RMS when a record stream is denied access to a record.
- You can have the requesting service wait for access (wait-if-locked option).
- You can have the requesting service ignore the lock (read-regardless option).

The following table lists the options for having RMS handle record locking conflicts and how you select each option through the FDL and RMS interfaces.

| Option              | Interface    | How to Select  |
|---------------------|--------------|--|
| Wait if locked      | FDL:<br>RMS: | CONNECT WAIT_FOR_RECORD<br>RAB\$L_ROP RAB\$V_WAT   |
| Wait timeout period | FDL:<br>RMS: | CONNECT TIMEOUT_ENABLE and<br>CONNECT TIMEOUT_PERIOD<br>RAB\$L_ROP RAB\$V_TMO and RAB\$B_TMO |
| Read regardless     | FDL:<br>RMS: | CONNECT READ_REGARDLESS<br>RAB\$L_ROP RAB\$V_RRL   |

The following sections describe each of these options.

#### 7.2.3.1 Handling the Record-Locked Error

When a service is denied record access because of a record conflict, it returns a record-locked error status (RMS\$\_RLK) that indicates the access attempt failed because the record was locked. One option is to have the application program pause briefly, and then try again to access the record.

Example 7–1 contains a program fragment written in VAX MACRO that demonstrates one method of implementing a short pause between attempts to access a locked record.

#### Example 7–1 Designing a Pause Between Attempts to Access a Record

```

.
.
.
10$:  $GET   RAB=INRAB           ; Get the record
      BLBS  R0,GOT RECORD      ; Branch on success
      Cmpl  R0,#RMS$_RLK      ; Record-locked error?
      BNEQ  ERROR             ; Quit on other errors
      PUSHAL ONE_SECOND       ; Pause for
      CALLS #1,_G^LIB$WAIT     ; One second
      BLBC  R0,ERROR          ; Quit on error
      BRB   10$               ; Try again for record
.
.
.

```

For more information about process control techniques, see the *OpenVMS System Services Reference Manual*.

### 7.2.3.2 Waiting for Locked Records

Another option for handling record-locking conflicts is to use the wait-if-locked option to wait for the locked record to be released. When you take this option, the accessing service does not return until the record is released or until a specified wait period expires.

The optional wait period is established using the wait-timeout-period option in conjunction with the wait-if-locked option. If the specified wait period expires before the requesting service obtains access to the locked record, the requesting service discards the request. The requesting service returns a completion status indicating that it waited for the locked record but was not granted access within the specified time period (RMS\$\_TMO).

If you select the wait-if-locked option and the requesting service must wait to access the record, it returns an alternate success status that indicates that it had to wait (RMS\$\_OK\_WAT).

### 7.2.3.3 Reading Regardless of Lock

The third choice available to you for handling record-locking conflicts involves using the read-regardless (of lock) option. This option allows the accessing service to ignore a lock that prohibits read access. If a lock is granted under the specified record-locking option, access is granted and the service returns with the specified lock. If the lock is denied, the read-regardless option allows the accessing service, Get or Find, to read the record, regardless of the lock. The service returns without a lock for all three file organizations, but the returned status depends on the file organization:

- For sequential files, the service returns RMS\$\_SUC.
- For relative and indexed files, the service returns alternate success status, RMS\$\_OK\_RRL.

An application program might use the read-regardless option to avoid record locking conflicts when a coordinated view of a record is not necessary. This option can also be used to continue sequential reads through a locked record.

Note that when you use the read-regardless option with the wait-if-locked option and a wait timeout period, RMS acts on the read-regardless option only after the wait timeout expires.

## 7.2.4 Miscellaneous Record-Locking Options

This section describes two miscellaneous record-locking options—the manual-unlocking option and the lock-nonexistent-record option in a relative file.

### 7.2.4.1 Manual-Unlocking Option

The manual-unlocking option gives the application program explicit control over releasing a record lock established by the Get service, the Find service, or the Put service as described in Section 7.2.1.

Even if you select the manual-unlocking option, RMS unlocks affected records when a record stream is disconnected (Disconnect service), or when a file is closed (Close service). Other record operations, including operations that result in errors, do not unlock the record.

To manually release record locks, the application program can invoke the Free service to unlock all record locks held by a record stream, or it can invoke the Release service to selectively release record locks, using the record's RFA.

## File Sharing and Buffering

### 7.2 Record Locking

Manual unlocking is useful when you have to modify multiple records as part of a single transaction. For example, assume the application program must modify two related but separate records. Assume, too, that the modified first record must not be accessed by another record stream until modifications to the second record are completed.

While the program modifies the first record, it uses the manual-unlocking option to hold the lock on the modified first record. It then proceeds to modify the second record while still maintaining a lock on the first record. By using manual unlocking, the application program can restore the original contents of the first record if the update to the second record fails, thereby maintaining data integrity.

#### 7.2.4.2 Lock-Nonexistent-Record Option

The lock-nonexistent-record option applies only to random accessing of relative files. Relative files have a static physical structure made up of record cells in contrast to sequential files and indexed files, which have a dynamic structure. The record cells may or may not contain records. A record may have been deleted from a cell, or the cell may be empty (that is, it never contained a record). In either case, the record cells are accessible to the application program.

Typically, if a record stream tries to access and lock an empty cell in a relative file using random access, the accessing service returns a record-not-found error status (RMS\$\_RNF). However, if the lock-nonexistent-record option is selected, the accessing service returns an alternative success status (RMS\$\_OK\_RNF) indicating that the record stream accessed a cell that never contained a record. If the cell contains a deleted record, RMS returns the deleted record with an alternate success status (RMS\$\_OK\_DEL) to indicate that a deleted record was accessed.

The lock-nonexistent-record option prevents other record streams from putting a record into an empty cell until the locking record stream puts a record in it or releases the record lock. Any other record stream that tries to access the cell to put data into it receives a record-locked status (RMS\$\_RLK). If the record stream that has the lock puts a record into the cell, RMS returns an alternate success status (RMS\$\_OK\_ALK) indicating that the cell was already locked. In general, the RMS\$\_OK\_ALK status is returned when a service tries to lock a record that the current record stream has already locked. This also applies to the Put service, which locks and unlocks the record in one record operation.

The next table lists miscellaneous record-locking options and how you select each option through the FDL and RMS interfaces:

| Option                  | Interface | How to Select              |
|-------------------------|-----------|----------------------------|
| Manual unlocking        | FDL:      | CONNECT MANUAL_UNLOCKING   |
|                         | RMS:      | RAB\$L_ROP RAB\$V_ULK      |
| Lock nonexistent record | FDL:      | CONNECT NONEXISTENT_RECORD |
|                         | RMS:      | RAB\$L_ROP RAB\$V_NXR      |

#### 7.2.5 Record-Locking Deadlocks

A deadlock occurs when there is a set of processes and each process is waiting to access a record that is locked by another process in the set. The program stalls because none of the processes can acquire the record that it needs to complete its task and release its locks.

The lock manager resolves the deadlock by denying one of the lock requests. When this occurs with a record lock, RMS returns an RMS\$\_DEADLOCK status. The RMS\$\_DEADLOCK status is only returned if the wait-if-locked option is selected. If your application program does its own wait and retry handling, the deadlock will occur, but the lock manager will not detect it.

The amount of time that lapses before RMS takes action on the deadlock depends on the value specified in the DEADLOCK\_WAIT system parameter. The default value for this system parameter is 10 seconds. For further details about how this parameter is set, see the *OpenVMS System Manager's Manual*.

### 7.2.5.1 Record Locking Options to Control Deadlock Detection

RMS uses the distributed lock manager (\$ENQ system service) for record locking.

To help prevent false deadlocks, the distributed lock manager uses the following flags for lock requests.

| Flag <sup>1</sup> | Purpose   |
|-------------------|---|
| LCK\$_NODLCKWT    | When set, the lock management services do not consider this lock when trying to detect deadlock conditions.                         |
| LCK\$_NODLCKBLK   | When set, the lock management services do not consider this lock as blocking other locks when trying to detect deadlock conditions. |

---

<sup>1</sup>Improper use of these flags can result in the lock management services ignoring genuine deadlocks. For complete flag information, see the \$ENQ section of the *OpenVMS System Services Reference Manual: A-GETUAI*.

In previous releases to OpenVMS Version 7.2-1H1, RMS did not set these flags in its record lock requests.

With OpenVMS Version 7.2-1H1, you can optionally request that RMS set these flags in record lock requests by setting the corresponding options RAB\$\_NODLCKWT and RAB\$\_NODLCKBLK in the new RAB\$\_W\_ROP\_2 field. For more information about using these options, see the flag information in the \$ENQ section of the *OpenVMS System Services Reference Manual: A-GETUAI*.

For more information about the lock manager, see the *OpenVMS System Services Reference Manual*.

## 7.3 Local and Shared Buffering Techniques

One of the key performance factors is record buffering, that is, the transfer of records between a storage device and an area of memory accessible to the application program. Between the storage device and the record buffer in the application program, however, is an intermediate buffer area that RMS maintains. An intermediate buffer area is usually associated with each process; you can also specify a shared buffer area for a shared file.

### 7.3.1 Record Transfer Modes

For synchronous and asynchronous record operations, RMS provides two record transfer modes: move mode and locate mode.

In move mode, RMS copies a record from an I/O buffer into a buffer that you specify. For input operations, data is first read into the I/O buffer from a peripheral device (such as a disk), then moved to your application program buffer for processing. For output operations, you first build the record in your

## File Sharing and Buffering

### 7.3 Local and Shared Buffering Techniques

application program buffer; then RMS moves the record to the I/O buffer that is used to transfer the record to disk.

In locate mode, RMS allows the application program to access records in an I/O buffer by providing the address of the returned record as the internal buffer location instead of an application program buffer location (field RAB\$L\_RBF). Usually, this reduces program overhead because records can be processed directly within the I/O buffer. Locate mode is only available for input operations. Because it may not always be possible to use locate mode, you must supply an application program buffer for cases in which move mode must be used, even though you specify locate mode (see the *OpenVMS Record Management Services Reference Manual*).

Other RMS facilities allow programs to control I/O buffer space allocation or to leave space management to RMS. The following sections describe buffering.

#### 7.3.2 Understanding Buffering

Your program perceives RMS record processing as the movement of records between a file and the program itself. In fact, RMS uses internal memory areas called I/O buffers to read or write blocks or buckets of data. Transparent to your program, RMS transfers blocks or buckets of a file into or from an I/O buffer. Records within the I/O buffer are then made available to the program when RMS transfers the records between the I/O buffer and the application program's record buffer.

The unit of data transfer between a file and the I/O buffers depends on the file organization. For the sequential organization, RMS reads and writes a block or series of blocks. For relative and indexed organizations, RMS reads and writes buckets.

The relationship between the application program and the I/O buffers that RMS maintains is shown in Figure 7-2. As illustrated, the application program resides in the P0 region of process address space. The RMS-maintained buffer area, together with RMS-maintained control information, resides in the P1 region.

Note that RMS normally overflows into P0 space and that the linker provides options for controlling the overflow. Note, too, that linker options are available for allocating additional buffer space in the P0 region, if needed. See the *OpenVMS Linker Utility Manual* for details.

## File Sharing and Buffering

### 7.3 Local and Shared Buffering Techniques

Figure 7-2 RMS Buffers and the Application Program

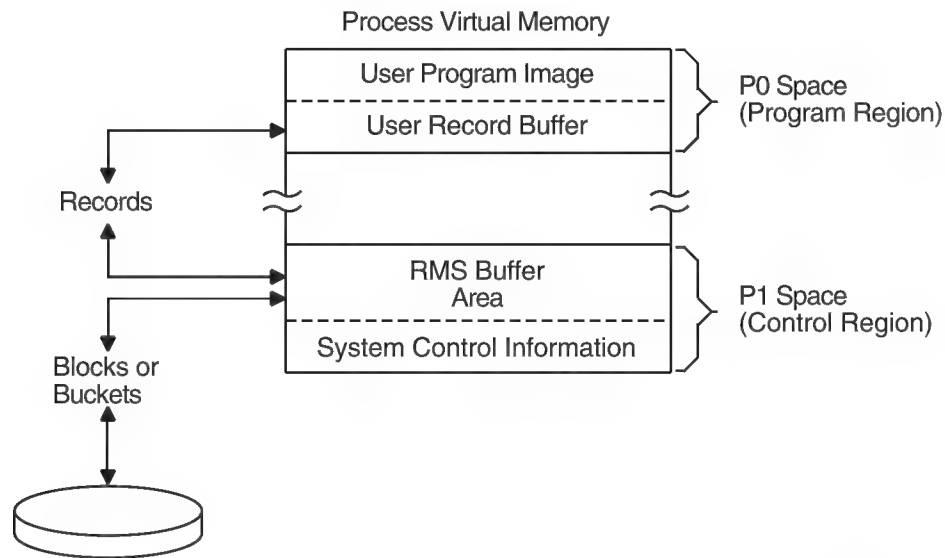

ZK-1993-GE

The specified record buffer contains the record to be read or written, and RMS maintains the rest of the block in application program process space in an RMS-controlled area of the program.

For optimum performance, consider the number of buffers carefully. The defaults calculated by RMS are few and may be adequate for access to small files. For example, it is not unusual to specify many buffers when processing a large indexed file, yet the default number of buffers RMS provides is only two.

The `CONNECT` secondary attribute `MULTIBUFFER_COUNT` establishes the number of local buffers, but the `FILE` secondary attribute `GLOBAL_BUFFER_COUNT` (FAB field `FAB$W_GBC`) specifies the number of *global buffers* as described in Section 7.3.6.

Often the best way to achieve optimum buffering for a particular application program is to use combinations of buffer sizes and numbers of buffers. One approach is to time each combination and measure the number of I/O operations. Then consider the amount of memory used before you choose the one that improved application program performance the most.

With buffering, the goal is to use a buffer size and number of buffers that improves application program performance without exhausting the virtual memory resources of your process or system. Keep in mind the trade-offs between file I/O performance and exhausting memory resources. The buffers used by a process are charged against the process's working set. You should avoid allocating so many buffers that the CPU spends excessive processing time paging and swapping. For performance-critical application programs, consider increasing the size of the process working set and adding additional memory.

The system manager should monitor the paging and swapping activity of the application program's process and selected other processes to avoid improving the performance of the target application program at the expense of other

## File Sharing and Buffering

### 7.3 Local and Shared Buffering Techniques

application programs. Have your system manager consult the *Guide to OpenVMS Performance Management* <sup>1</sup>

When records are accessed sequentially, a large buffer (or buffers) should be used. Contiguous records in a file are read into memory in one or more blocks for sequential files or in buckets (multiblock units) for relative and indexed files. After the blocks or buckets are read into the buffer area provided by RMS, later access to adjacent records would access records in the same block or bucket in the buffer. This eliminates additional I/O and improves performance. When a record is needed that is not in the current buffer cache, one of the buffers is replaced by the blocks or the bucket that contains the new record.

When records in the file are repeatedly accessed, using more than one buffer can hold the previously accessed records in memory longer and eliminate an I/O operation when the program accesses the records again.

The buffers that the application program requests RMS to allocate for its use are referred to as a **buffer cache** and can be thought of as a buffer pool for your process. RMS uses buffer caches to locate records first before attempting I/O to the target device. When many processes share a file, the program can use a shared global buffer cache. (See Section 7.3.6.)

#### 7.3.3 Buffering for Sequential Files

With sequential files, the number of local buffers and the size of the local buffers can be specified at run time. You specify the number of local buffers with the FDL attribute `CONNECT MULTIBUFFER_COUNT` and you specify the buffer size with the FDL attribute `CONNECT MULTIBLOCK_COUNT`.

Sequential files provide an option that uses two buffers. One buffer holds records to be read from the disk or written to the disk. The other buffer awaits I/O completion. This is called **read-ahead and write-behind processing** and should be considered for sequential access to sequential files. The number of buffers (`CONNECT MULTIBUFFER_COUNT`) should be specified as 2. The length of the buffers used for sequential files is determined by the specified multiblock count (`CONNECT MULTIBLOCK_COUNT`). For sequential access to a sequential file, the optimum number of blocks per buffer depends on the record size, but a value such as 16 is usually appropriate.

To see the default buffer count for the current process, use the DCL command `SHOW RMS_DEFAULT`. To set the default buffer count for the current process, use the DCL command `SET RMS_DEFAULT/SEQUENTIAL/BUFFER_COUNT=n`, where *n* is the number of buffers.

#### 7.3.4 Buffering for Relative Files

With relative files, buckets, not blocks, are the unit of transfer between the disk and memory. The bucket size is specified when the file is created, although the bucket size of an existing file can be changed by converting the file (see Chapter 10).

The bucket size is specified by the FDL attribute `FILE BUCKET_SIZE` (VMS RMS control block field `FAB$B_BKS` or `XAB$B_BKZ`). When choosing this value, you should consider whether or not the file is usually accessed randomly (small bucket size), sequentially (large bucket size), or both (medium bucket size), as described in Chapter 2.

---

<sup>1</sup> This manual has been archived but is available on the OpenVMS Documentation CD-ROM. A printed book can be ordered by calling 800-282-6672. For information about the resources needed for file applications, refer to Section 1.8.

## File Sharing and Buffering

### 7.3 Local and Shared Buffering Techniques

You can specify the number of local buffers (CONNECT MULTIBUFFER\_COUNT) at run time. The type of record access to be performed determines the best use of local buffers. The two extremes of record access are that records are processed completely randomly or completely sequentially. Also, there are cases in which records are accessed randomly but may be reaccessed (random with temporal locality), and cases in which records are accessed randomly but adjacent records are likely to be accessed (random with spatial locality).

For completely random or sequential access, a single buffer should be specified. In a processing environment in which the program processes records randomly and sometimes reaccessed records, use multiple buffers to keep the reaccessed records in the buffer cache.

When records are accessed randomly and adjacent records are apt to be accessed, you should specify a single buffer. However, if your program is processing a file with small bucket sizes, you should consider specifying more buffers. When the file is likely to be accessed by several methods, you should consider a compromise of the number of buffers and bucket sizes.

When adding records to a relative file, consider choosing the deferred-write option (FDL attribute FILE DEFERRED\_WRITE; FAB\$L\_FOP field FAB\$V\_DFW). With this option, the buffer (memory-resident bucket) into which the records have been moved is not written to disk until the buffer is needed for other purposes or until the file is closed. Note that if you use the deferred-write option, there is a risk that data may be lost if a system crash occurs before the records are written to disk.

To see the current process-default buffer count, use the DCL command SHOW RMS\_DEFAULT. To set the process-default buffer count, use the DCL command SET RMS\_DEFAULT/RELATIVE/BUFFER\_COUNT=*n*, where *n* is the number of buffers.

#### 7.3.5 Buffering for Indexed Files

With indexed files, buckets (not blocks) are the units of transfer between the disk and memory. The bucket size is specified when the file is created, although the bucket size of an existing file can be changed by converting the file (see Chapter 10).

The bucket size is specified by the FDL attribute FILE BUCKET\_SIZE (VMS RMS control block field FAB\$B\_BKS or XAB\$B\_BKZ), as described in Chapter 2.

When accessing indexed files, it is important to remember that the index portion of the file must be read by RMS to locate the desired record. The algorithm used by RMS places a higher priority for the higher-level buckets of the index in the buffer cache. Thus, the highest levels of the index remain in the buffer cache, while the buffers that may have contained the actual data buckets and the lower-level index buckets are reused to contain other buckets. That is, the buffers that are reused first contain either data or lower-level index buckets, which are the first to be discarded from the buffer cache.

When accessing indexed files, the number of local buffers (CONNECT MULTIBUFFER\_COUNT) is specified at run time and recommended values can vary greatly for different application programs. When records are processed randomly, use as many buffers as your process working set can support to cache additional index buckets. When records are accessed sequentially, even after locating the first record randomly, use a small multibuffer count, such as the default of 2 buffers.

## File Sharing and Buffering

### 7.3 Local and Shared Buffering Techniques

Many application programs access files using a mixture of completely random and completely sequential processing. For such application programs, a compromise of the above number of buffers is recommended.

When adding records to an indexed file, consider choosing the deferred-write option (FDL attribute `FILE DEFERRED_WRITE`; `FAB$L_FOP` field `FAB$V_DFW`). With the deferred-write option, the buffer into which the records have been moved is not written to disk until the buffer is needed for other purposes or until the file is closed. This option, however, may cause records to be lost if a system crash should occur before the records are written to disk.

To see the current process-default buffer count, use the DCL command `SHOW RMS_DEFAULT`. To set the process-default buffer count, use the DCL command `SET RMS_DEFAULT/INDEXED/BUFFER_COUNT=n`, where *n* is the number of buffers.

#### 7.3.6 Using Global Buffers for Shared Files

Two types of buffer caches are available using RMS: local and global. Local buffers reside within process (program) memory space and are not shared among processes, even if several processes access the same file and read the same records. Global buffers, which are designed for application programs that access the same files and perhaps the same records, do not reside in process memory space.

If several processes share a file, you should specify that the file uses global buffers. A global buffer is an I/O buffer that two or more processes can access in conjunction with file sharing. If two or more processes request the same information from a file, each process can use the global buffers instead of allocating its own process-local buffers. Figure 7-3 illustrates the use of global buffers.

## File Sharing and Buffering

### 7.3 Local and Shared Buffering Techniques

Figure 7-3 Using Global Buffers for a Shared File

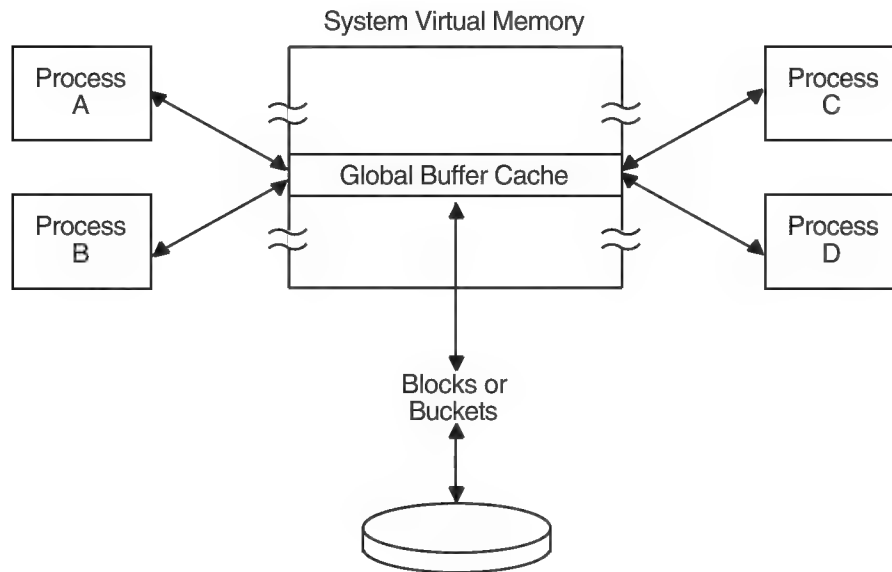

ZK-1994-GE

Unlike local buffers, global buffers can be accessed by multiple processes accessing the same file. When a record requested by one process is located in a global buffer, the record can be transferred directly from the global buffer to the program, eliminating an I/O read operation. Note that if the previous accessor modified the record, RMS writes the buffer to disk before returning the record to the new accessor. This ensures that the modified bucket in memory matches its counterpart on the disk.

There are two situations in which global buffers cannot be used for shared files. When a process permanent file is being accessed, RMS does not use global buffers (no error is returned). When an image is linked using the LINK option keyword IOSEGMENT=NOPOBUFS (rarely used), RMS does not use global buffers.

Even if global buffers are used, a minimal number of local buffers should be requested, because, under certain circumstances, RMS may need to use local buffers. When attempting to access a record, RMS looks first in the global buffer cache for the record before looking in the local buffers; if the record is still not found, an I/O operation occurs. When using the deferred-write option with global buffering enabled, the number of buckets that can be buffered without I/O is equal to the number of local buffers; thus, the use of more than the minimum number of local buffers should be considered.

You can specify the number of global buffers two ways: by using a preset file default or by having the first process that accesses the file specify the value at run time. To set the file default (maintained in the file header), use the DCL command SET FILE/GLOBAL\_BUFFERS=*n* where *n* is the number of buffers.

To set the global buffer value at run time, the first process to connect to the file with the FILE GLOBAL\_BUFFER\_COUNT attribute (FAB field FAB\$W\_GBC) greater than 0 can set this value. The default value returned in the FAB\$W\_GBC field following an Open (or Create) service may be altered if unacceptable before invoking the Connect service. When a previous or subsequent application program attempts to open and connect to the file, the global buffer count

## File Sharing and Buffering

### 7.3 Local and Shared Buffering Techniques

determines whether or not that process uses global buffers. If the value is 0, that process uses only local buffers; if the value is greater than 0, that process uses global buffers along with other processes. Refer to the *OpenVMS Record Management Services Reference Manual* for additional information on the use of the FAB\$W\_GBC field and Connect service. An example of a routine that sets the global buffer count after opening a file is provided in Example 5-2.

To request that the global buffer cache be read-only, specify SHARING GET and SHARING MULTISTREAMING attributes (FAB\$B\_SHR field FAB\$V\_SHRGET and FAB\$V\_MSE).

When modifying an application program to use global buffers, consider using more global buffers and slightly larger bucket sizes if records are processed randomly. For application programs with many users, consider allocating a number of global buffers equal to the number of local buffers used previously, multiplied by number of users (if resources permit):

No. Global Buffers = No. Local Buffers x Average No. Users

When using an indexed file, if the index structure is small and the number of users is many, consider allocating enough global buffers to keep the entire index structure in memory.

For shared sequential file operations, the first accessor of the file uses the multiblock count value to establish the global buffer size for all subsequent accessors.

#### 7.3.6.1 Enhancing Global Buffer Performance

OpenVMS includes enhancements that improve RMS global buffer performance. These features are greater scalability, greater concurrent access to the global section, and read-mode bucket locking for shared access to global buffers.

##### **Greater Scalability**

RMS implements an algorithm for global buffer management that dramatically improves scalability. The performance associated with the previous algorithm effectively limited the maximum number of global buffers on large, shared files. With this change, you may increase the number of global buffers on these files to the full limit of 32,767 to fully exploit large memory systems.

##### **Concurrent Access**

RMS synchronizes access to the global section that is used for RMS global buffers by using inline atomic instruction sequences rather than distributive locking. This change allows more concurrent access to the section, particularly on symmetric multiprocessing machines (SMP).

Greater scalability benefits those who wish to use very large global buffer counts. Concurrent access to the global section helps any application using global buffers where contention on the global section itself is a bottleneck.

---

##### **Note**

By increasing the number of global buffers on specific files, you may need to increase the size of some of the system resources. In particular, you may need to increase the sysgen parameters GBLPAGES, GBLPAGFILE, or GBLSECTIONS. In addition, you may need to increase the process working set size and the page file quota.

---

## File Sharing and Buffering

### 7.3 Local and Shared Buffering Techniques

#### Read-Mode Bucket Locking (Alpha Only)

RMS reduces locking for shared access to global buffers and improves performance with its implementation of read-mode global bucket locking, which has the following functionality:

- Allows concurrent read access to the global buffers. Accesses are no longer serialized, waiting to acquire an exclusive lock for a read access.
- Caches the read-mode lock as a system lock, which is retained over accesses and only lowered to null when the lock is blocking an exclusive write request. This functionality significantly reduces both local and remote lock request traffic (the number of \$ENQ and \$DEQ system service calls) as well as associated IPL-8 spinlock activity and System Communications Services (SCS) messages for a cluster.
- Does not increase lock resource names or the number of active system or process locks on the system.
- Is functionally compatible in mixed version clusters that include both Alpha and VAX computers.

This functionality applies to read operations (using the \$GET and \$FIND services) for all three file organizations: sequential, relative, and indexed. It also applies to a write operation (using the \$PUT service) for the read accesses used for index buckets the first time through an index tree for the write.

You do not need to change existing applications to implement the read-only global bucket locks. However, global buffers must be set on a data file to take advantage of the enhancement. Use the following DCL command, where *n* is the number of buffers:

```
$ SET FILE/GLOBAL_BUFFER=n <filename>
```

For information about specifying the number of buffers, refer to the *OpenVMS DCL Dictionary*. For general information about using global buffers, refer to the *Guide to OpenVMS File Applications*.

In a mixed cluster environment where there may be high contention for specific buckets, the Alpha nodes that are using read-mode global bucket locking may dominate accesses to write-shared files, thereby preventing timely access by other nodes.

With the `/CONTENTION_POLICY=keyword` qualifier to the SET RMS\_DEFAULT command, you can specify the level of locking fairness at either the process or system level for environments that experience high contention conditions.

For more information about using the `/CONTENTION_POLICY=keyword` qualifier, refer to the *OpenVMS DCL Dictionary*.



---

## Record Processing

This chapter describes record processing to help you use the run-time record operations described in Chapter 9. This chapter provides information about the following subjects:

- Record operations appropriate to high-level languages
- Record operations for file organizations
- Record environment as it relates to record positioning
- Synchronous versus asynchronous record operations

### 8.1 Record Operations

Record operations are performed by OpenVMS RMS (hereafter referred to as RMS) primary or secondary services. Primary services have functional equivalents in high-level language record operations, whereas secondary services are specific to RMS functions.

Section 8.2 describes the five primary services. For a brief description of the secondary services, refer to Section 8.3, and for more detailed descriptions of the secondary services, refer to the *OpenVMS Record Management Services Reference Manual*.

### 8.2 Primary Services

This section describes the five services that are functionally similar to related high-level language operations. The following table provides a brief description of each of these services and cites the similarities to high-level languages:

|      |   |
|------|---|
| Find | The Find service locates an existing record in the file. It does not return the record to your program; instead it establishes the record's location as the current-record position in the record stream. The Find service, when applied to a disk or magnetic tape file, corresponds to the FIND statement in BASIC and Fortran, the START statement in COBOL, the FIND and LOCATE statements in Pascal, and the READ statement with the SET keyword for PL/I. |
| Get  | The Get service returns the selected record to your program. The Get service, when applied to a disk or magnetic tape file, corresponds to (is used by) the GET statement in BASIC; the READ statement in COBOL, Fortran, and PL/I; and the GET statement (and others) in Pascal.   |
| Put  | The Put service inserts a new record in the file. The Put service, when applied to a disk or magnetic tape file, corresponds to the PUT and PRINT statements in BASIC, the WRITE statement (and others) in COBOL, the WRITE statement in Fortran and PL/I, and the PUT and WRITELN statements in Pascal.  |

## Record Processing

### 8.2 Primary Services

|        |  |
|--------|--|
| Update | The Update service modifies an existing disk file record. The Update service corresponds to the UPDATE statement in BASIC and Pascal and to the REWRITE statement in COBOL, Fortran, and PL/I. |
| Delete | The Delete service erases records from relative disk files and indexed disk files. The Delete service corresponds to the DELETE statement in BASIC, COBOL, Fortran, Pascal, and PL/I.          |

A single statement in a high-level language may correspond to one or several RMS record-processing service calls. For example, the COBOL statement DELETE uses the Delete service during sequential record access, but it uses the Find and Delete services during random record access.

File organization in part determines the types of record operations that a program can perform. Table 8–1 shows the major record operations that RMS permits for each file organization.

**Table 8–1 Record Operations and File Organizations**

| Record Operation Permitted | File Organization |          |         |
|----------------------------|-------------------|----------|---------|
|                            | Sequential        | Relative | Indexed |
| Get                        | Yes               | Yes      | Yes     |
| Put                        | Yes <sup>1</sup>  | Yes      | Yes     |
| Find                       | Yes               | Yes      | Yes     |
| Delete                     | No                | Yes      | Yes     |
| Update                     | Yes <sup>2</sup>  | Yes      | Yes     |

<sup>1</sup>In a sequential file, RMS allows records to be added at the end of the file only. (Records can be written to other points in the file by using a Put service with the update-if option.)

<sup>2</sup>When performing an Update service to a sequential file containing fixed-length records, you cannot change the length of the record. The Update service is allowed only on disk devices.

The remainder of this section briefly describes the record retrieval (Find and Get) services, the record insertion (Put) service, the record modification (Update) service, and the record deletion (Delete) service. Note that all references to services imply applicability to similar functional capabilities found in high-level languages.

#### 8.2.1 Locating and Retrieving Records

You can use the Find and Get services to locate and retrieve a record. The Find service locates a record and establishes its location as the current-record position in a record stream but does not return the record to a buffer. The Get service locates the record, establishes its location as the current-record position in the record stream, and returns it to the buffer area you specify.

If you use the Get service, you must allocate a buffer area in the data portion of your program to store the retrieved record by defining an appropriate variable or multivariable record structure in the program.

---

#### Note

---

When you invoke the Get service, RMS takes control of the record buffer and may modify it. RMS returns the record size but it can guarantee record integrity only from the access point to the end of the record.

---

In addition to retrieving the record, RMS returns to your program the length of the record (in control block field RAB\$W\_RSZ, record size) and the file address of the record (in control block field RAB\$L\_RBF, record buffer). If you direct RMS only to locate the record, it does not write the record into your buffer. Instead, it sets the RAB\$W\_RSZ and RAB\$L\_RBF fields to point to an internal buffer where the record is located.

When using indexed files, you may need to allocate a buffer for the desired key and to specify its length. When using high-level languages, the language's compiler may automatically handle the allocation and size specification of the record buffer and the key buffer.

In some applications, you can minimize record I/O and improve performance by using the Find service instead of the Get service. For example, a process does not have to retrieve a record when it is preparing to invoke the Update, Delete, Release, or Truncate service. If a process intends to update a record that is accessible to other processes, it should lock the record until it completes the update.

For interactive applications where the user verifies that the appropriate record is being accessed before deleting it or updating it, the program should use the Get service instead of the Find service.

In some situations, a process may use two services and two types of record access to retrieve a set of records. For example, the process might use the Find service and random access mode to locate the first record in the set and then switch to the Get service for sequentially retrieving the records in the set.

An efficient use of the Find service is to create a table of RFAs (record file addresses) to be used for rapidly accessing the records in the same file.

Record retrieval operations are typically used to repetitively read and process a set of records. As part of this type of operation, your program should check for an end-of-file condition after each Find or Get service.

For more information about the Find and Get services, refer to the *OpenVMS Record Management Services Reference Manual*.

#### 8.2.2 Inserting Records

The Put service adds a record to the file. Within the data portion of your program, you must provide a buffer for the record to be added. When calling RMS directly, the program must also supply the length of each record to be written. This is a constant value with fixed-length records but varies from record to record when adding variable-length or VFC records. When using high-level languages, however, the language's compiler may automatically specify the record buffer size or supply a means to simplify its specification.

The current-record position is especially important when adding records to a sequential file. RMS establishes the current-record position at the end of file for any record stream associated with a file opened for adding records. To add records to a relative file or to an indexed file, use random access (by key or record number), unless the program adds records sequentially by a specified ordering of primary keys or by relative record number.

The update-if option replaces an existing record using the Put service when you choose random access mode. When superseding existing records, consider using this option to add records to a relative or indexed file. A program can use the update-if option to update a record in a sequential file that is being accessed randomly by relative record number.

## Record Processing

### 8.2 Primary Services

Be careful with automatic record locking when you use this option for a shared file because the Put service briefly releases record locks applied by the Get or Find service before the Update operation begins. This could permit another record stream to delete or update the record between the time that the program invokes the Put service and the beginning of the Update service.

Consider using the Update service instead of the Put service with the update-if option to update an existing record in a shared file.

When a file contains alternate keys with characteristics that prohibit duplicate values, the application must be prepared to handle duplicate-alternate-key errors.

For more information about the Put service, refer to the *OpenVMS Record Management Services Reference Manual*.

#### 8.2.3 Updating Records

The Update service modifies an existing record in a file. Your program must first locate the appropriate record and optionally retrieve the record itself, by calling either the Find service or the Get service. As with the Put service, your program must provide a buffer within the data portion of the program to hold the record that is to be updated.

When calling RMS directly, the program must also supply the length of each record to be written. This is a constant value when updating fixed-length records but varies from record to record when updating variable-length records or VFC records. Note that some high-level language compilers may automatically handle record buffer allocation and size specification or may supply a means to simplify its specification.

Your program must establish the current-record position before it updates a record. If the file is shared, the service that establishes the record position should also lock the record.

When you update indexed file records, take care not to alter the value of any key field that has been specified as unchangeable, for example, the primary key. To change the value of a record's primary key, you must replace the existing record with a new record having the desired primary key value. You can do this using the Put and Delete services respectively, or, where applicable, you may use the Put service with the update-if (RAB\$L\_ROP RAB\$V\_UIF) option.

When updating indexed file records, you do not have to specify the key of reference.

For more information about the Update service and record-processing options, refer to the *OpenVMS Record Management Services Reference Manual*.

#### 8.2.4 Deleting Records

The Delete service removes a record from the file. You cannot delete individual records from sequential files, but you can truncate sequential files using the Truncate service. As with the Update service, the Delete service must be preceded by a Find or Get service to establish the current-record position.

When deleting records from an indexed file with alternate indexes, you can specify the fast-delete option to reduce the amount of time needed to delete a record. When you invoke the Delete service and specify the fast-delete option, RMS does not attempt to remove any of the pointers from alternative indexes to the deleted record.

You improve performance by postponing the processing needed to eliminate the pointers from alternative indexes to the record. However, there are disadvantages to using the fast-delete option:

- The unused pointers from the alternate indexes result in a corresponding waste of space.
- If the program later tries to access the deleted record from an alternate index, RMS must traverse the pointer linkage, find that the record no longer exists, and then perform the processing that was avoided originally with the Delete service.

Use the fast-delete option only if the immediate improvement in performance is worth the added space and overhead. Typically, you use the fast-delete option for indexed files that implement alternate keys and require frequent maintenance.

Conversely, avoid the fast-delete option for most read-only indexed files and for indexed files that are infrequently updated.

For more information about the Delete service, refer to the *OpenVMS Record Management Services Reference Manual*.

### 8.3 Secondary Services

This section provides very brief descriptions of the secondary services. Note that each of the services performs a specialized function with few options.

|             |   |
|-------------|---|
| Connect     | Allows you to connect to a single record stream or to multiple record streams.  |
| Disconnect  | Allows you to disconnect a record stream. This is done implicitly when a file is closed, but when using multiple record streams, you may want to disconnect one record stream but not others. |
| Flush       | Writes modified I/O buffers and file attribute information maintained in memory to the file.  |
| Free        | Releases all record locks established by the current record stream.   |
| Next Volume | Continues the next volume of a magnetic tape volume set. This service applies only to sequential files.   |
| Release     | Releases the record lock on the current record.   |
| Rewind      | Positions the record stream context to the first record of the file.  |
| Truncate    | Truncates a file beginning with the current record, effectively deleting it and all remaining records. This service applies only to sequential files.   |
| Wait        | Awaits the completion of an asynchronous record operation (or Connect service).   |

In addition to the record-processing services, a variety of file-processing services are also available. For more information about both types of processing services and the options that apply to each, see the *OpenVMS Record Management Services Reference Manual*.

### 8.4 Record Access for the Various File Organizations

To retrieve or insert a file record for a particular record stream, your program must specify either sequential or random access.

## Record Processing

### 8.4 Record Access for the Various File Organizations

Sequential access can be used with all file organizations. For sequential files, sequential access implies that records are accessed according to their physical position in the file. For relative files, sequential access implies that records are accessed according to the ascending order of relative record numbers. In indexed files, sequential access implies that records are accessed according to a specified ordering of values for a particular key or keys.

Random access is defined as one of the following:

- Random access by key for indexed files implies that RMS uses the specified key value (contained within the record itself) to locate the desired record.
- Random access by relative record number for relative files and for sequential files having fixed-length records implies that the specified relative record number is used to locate the desired record. The relative record number does not necessarily reside in the record.
- Random access by RFA implies that the specified RFA is used to locate the desired record. This access mode is supported for all three file organizations and is normally available only to programs written in VAX MACRO or similar low-level languages.

Record access is specified using language statements or by establishing the appropriate control block field values (not offset values) in the RAB.

---

#### Note

---

No FDL attributes are provided for specifying record access.

---

The appropriate RAB values in the access mode specification field, identified by the symbolic offset RAB\$B\_RAC, are as follows:

- You specify sequential access by inserting the value RAB\$C\_SEQ in the RAB\$B\_RAC field.
- You specify either random access by key or random access by relative record number by inserting the value RAB\$C\_KEY in the RAB\$B\_RAC field. This access mode is used to randomly access records in indexed files using a specified key value. It is also used to randomly access records by record number in relative files and in sequential files having fixed-length records.
- You specify random access by RFA for all file organizations by inserting the value RAB\$C\_RFA in the RAB\$B\_RAC field.

Your program may also need to specify the key or other record identifier needed to access the records. For indexed files, there are additional key-related options.

The record access mode can be changed without reopening the file or reconnecting the record stream. For example, you can use random access by key to establish the current-record position in an indexed file and then retrieve records sequentially by a specified sort order. Note, however, that changing modes in this manner requires program access to the RAB\$B\_RAC control block field at run time.

The record access mode, in conjunction with the file organization, is what determines the manner in which a record is selected. In the following sections, the sequential and random access modes are discussed in the context of the applicable file organizations. Random access by RFA is discussed separately because it applies to disk files, regardless of file organization.

## Record Processing

### 8.4 Record Access for the Various File Organizations

The following discussion of record access modes is directed primarily toward services that insert records and services that retrieve records. For additional details about these services, see the *OpenVMS Record Management Services Reference Manual*.

#### 8.4.1 Processing Sequential Files

A program can read sequential files on both tape and disk devices using the sequential record access mode. If the file resides on disk, the random access by RFA mode can be used to read records, and if the file uses the fixed-length record format, the random access by relative record number mode is permitted.

You can add records only to the end of a sequential file.

All record access modes permit you to establish a new current-record position in a sequential file using the Find service. With sequential access, the Find service permits you to skip over records. With either random access by relative record number or random access by RFA, the Find service establishes a starting point for sequential Get services.

You cannot randomly delete records from a sequential file. However, you can randomly update records in a sequential file if the file is on disk and if the update does not change the record size.

The following sections discuss the use of sequential and random access modes with sequential files.

##### 8.4.1.1 Sequential Access

The sequential access mode is supported for sequential files on all devices. It is the only record access mode that is supported for nondisk devices, such as terminals, mailboxes, and magnetic tapes.

With sequential access, RMS returns records from sequential files in the order in which they were stored. When a program has retrieved all of the records from a sequential file, any further attempt to sequentially access records in the file causes RMS to return an end-of-file (no more data) condition code.

In sequential access mode, you can add records *only* to the end of a sequential file, that is, the file location immediately following the current-record position.

##### 8.4.1.2 Random Access

You can use the relative record number to randomly retrieve and insert records in sequential files having fixed-length records. Records are numbered in ascending order, starting with number 1.

In a sequential file, records are usually inserted at the end of the file. To insert records randomly within the current boundaries of the file at a relative record number less than or equal to the highest record number, set the update-if option (FDL attribute CONNECT UPDATE\_IF; RAB\$L\_ROP bit RAB\$V\_UIF) to overwrite existing records.

When accessing a sequential file randomly by relative record number, your program must provide the record number at symbolic offset RAB\$L\_KBF and must specify a key length of 4 at symbolic offset RAB\$B\_KSZ, in the RAB.

## Record Processing

### 8.4 Record Access for the Various File Organizations

#### 8.4.2 Processing Relative Files

The relative file organization permits greater program flexibility in performing record operations than the sequential organization. A program can read existing records from the file using sequential, random access by relative record number mode or random access by RFA mode. You can write new records either sequentially or randomly, as long as the intended record location (cell) does not already contain a record. You can also delete records.

All record access modes for relative files allow you to establish the current-record position using the Find or Get service. After finding the record, RMS permits you to delete the record from the relative file. After the record is deleted, the empty cell becomes available for a new record. In addition, your program can update records anywhere in the file. For variable-length records, the Update service can modify the record length up to the maximum size specified when the file was created.

When you insert a record into a relative file, the record is placed in a fixed cell within the file. A cell within a relative file can contain a record, can be vacant (never have contained a record), or can contain a deleted record.

The following sections discuss the sequential and random access modes for relative files.

##### 8.4.2.1 Sequential Access

For relative files, the sequential access mode can be used to retrieve successive records in ascending record number. Vacant cells and cells that contain deleted records are skipped over automatically.

##### 8.4.2.2 Random Access

You can directly read a record within a relative file by specifying the appropriate relative record number. If you attempt to read from a nonexistent cell—that is, a vacant cell or a cell containing a deleted record—RMS returns an error message.

To position the record stream at a particular cell, regardless of whether or not it contains a record, use the nonexistent-record option (FDL attribute `CONNECT NONEXISTENT_RECORD`), or set the `RAB$V_NXR` bit in the `RAB$L_ROP` field.

You can use the forward search key options (equal-or-next-key and next-key) to directly access records in relative files, but the reverse search key options are not supported for relative files.

The equal-or-next-key option (FDL attribute `CONNECT KEY_GREATER_EQUAL`) directs RMS to return a record having a record number equal to or greater than the specified record number. For example, when you specify record number 48, RMS returns record number 48. If RMS does not find record number 48, it returns the first record it encounters having a number greater than 48.

The next-key option (FDL attribute `CONNECT KEY_GREATER_THAN`) directs RMS to return the record that has the next greater record number. For example, when you specify record number 48, RMS returns record number 49, if record 49 exists.

You can also use random access mode to insert records into relative files. You can even overwrite cells that contain records by selecting the update-if option (FDL attribute `CONNECT UPDATE_IF`) or by directly setting the `RAB$V_UIF` bit in the `RAB$L_ROP` field.

To access a relative file randomly by record number, your program must contain the relative record number in the RAB at symbolic offset RAB\$L\_KBF and the key length value 4 at symbolic offset RAB\$B\_KSZ.

### 8.4.3 Processing Indexed Files

Indexed files provide the most record-processing flexibility. Your program can read existing records from the file in sequential, random access by RFA mode or random access by key mode. RMS also allows you to write any number of new records into an indexed file if you do not violate a specified key constraint, such as not allowing duplicate key values.

In random access by key mode, RMS provides two forward search key options for use with one of four match options (see Section 8.4.3.2). A reverse search key option permits reverse random access when used in combination with either of the two forward search key options.

The search key options are:

- The equal-or-next-key option (FDL attribute CONNECT KEY\_GREATER\_EQUAL) searches the file forward (toward the end of the file) to return the next record whose key value is equal to or greater than the current key of reference, according to sort order.
- The next-key option (FDL attribute CONNECT KEY\_GREATER\_THAN) searches the file forward (toward the end of the file) to return the record whose key value is greater than the current key of reference, according to sort order.
- The reverse search key option is used with either the equal-or-next-key option or the next-key option to access selected records in reverse order. (This option does not reverse the direction of sequential access operations, which are always done in the forward direction, according to sort order.)

If the reverse search key option is used with the equal-or-next-key option, RMS searches the file backward (toward the beginning of the file) to return the previous record whose key value is equal to or less than the current key of reference, assuming according to sort order.

If the reverse search key option is used with the next-key option, RMS searches the file backward (toward the beginning of the file) to return the previous record whose key value is less than the current key of reference, according to sort order.

Table 8–2 lists the search key types for each option combination. Note that three of the listed combinations are not supported (not allowed) and result in the return of an error message.

**Table 8–2 Search Key Types**

| Search Key Type       | Search Key Option Settings |               |      |
|-----------------------|----------------------------|---------------|------|
|                       | Reverse                    | Equal or Next | Next |
| Equal <sup>1</sup>    | Off                        | Off           | Off  |
| Equal or greater than | Off                        | On            | Off  |

<sup>1</sup>Default forward search key

(continued on next page)

## Record Processing

### 8.4 Record Access for the Various File Organizations

**Table 8–2 (Cont.) Search Key Types**

| Search Key Type                 | Search Key Option Settings |               |      |
|---------------------------------|----------------------------|---------------|------|
|                                 | Reverse                    | Equal or Next | Next |
| Greater than                    | Off                        | Off           | On   |
| Not allowed                     | Off                        | On            | On   |
| Not allowed                     | On                         | Off           | Off  |
| Equal or less than <sup>2</sup> | On                         | On            | Off  |
| Less than (previous)            | On                         | Off           | On   |
| Not allowed                     | On                         | On            | On   |

<sup>2</sup>Default reverse search key

If you use the reverse search key option with a set of records that has duplicate keys, only the first record in the set is returned. An application that needs to access all records having duplicate key values requires additional compiler or program logic.

On-disk data structures are designed to provide optimum performance for forward searches. Reverse search performance may be diminished, especially for applications that process long chains of deleted records. To take advantage of built-in caching that improves performance when retrieving successive previous records, specify full key sizes and select the next-key option.

The following C program demonstrates the use of the search key option. The program reads the last and the next-to-last records in a file.

```

/*
  REVERSE-SEARCH

  The file is defined by the logical INFILE, and has record and
  key sizes defined below.
*/

#include <rms> /* defines rabs and fabs */
#include <stdio> /* defines printf */
#include <string> /* defines strlen */
#include <stdlib> /* defines exit */
#include <starlet> /* defines sys$open, et al */

#define RECORD_SIZE 80
#define KEY_SIZE 10

char INPUT_NAME[] = "INFILE";

struct FAB infab;
struct RAB inrab;

error_exit (code, value)
long code;
long value;
{
  void lib$signal();
  lib$signal (code, value);
  exit (0);
}

main ()
{
  char record [RECORD_SIZE + 1]; /* record buffer */
  char key [KEY_SIZE + 1]; /* key buffer */
  long status;

```

## Record Processing

### 8.4 Record Access for the Various File Organizations

```

/* Set up input fab */
infab = cc$rms_fab;
infab.fab$b_fac = FAB$M_GET | FAB$M_PUT | FAB$M_UPD | FAB$M_DEL;
infab.fab$b_shr = FAB$M_SHRGET | FAB$M_SHRPUT | FAB$M_SHRUPD
    | FAB$M_SHRDEL; /* read/write sharing */
infab.fab$l_fna = INPUT_NAME; /* logical name INFILE */
infab.fab$b_fns = sizeof INPUT_NAME - 1;

/* Set up input rab */
inrab = cc$rms_rab;
inrab.rab$l_fab = &infab;
inrab.rab$b_rac = RAB$C_KEY; /* key access */
inrab.rab$l_rop = RAB$M_REV | RAB$M_NXT;
    /* reverse-search, next */
inrab.rab$b_krf = 0; /* access by primary key */
inrab.rab$l_ubf = record; /* record buffer */
inrab.rab$w_usz = RECORD_SIZE; /* maximum record size */

/* Open and connect */
status = sys$open (&infab);
if (! (status & 1))
    error_exit (status, infab.fab$l_stv);
status = sys$connect (&inrab);
if (! (status & 1))
    error_exit (status, inrab.rab$l_stv);

/* Set key larger than the largest possible real key */
strcpy (key, "-");
inrab.rab$l_kbf = key; /* key buffer */
inrab.rab$b_ksz = 1; /* set key length */

/* Get and display the last record */
status = sys$get (&inrab);
if (! (status & 1))
    error_exit (status, inrab.rab$l_stv);
record[inrab.rab$w_rsz] = '\0';
printf ("Record: {%s}\n", record);

/* Set key to the (just-read) largest key */
inrab.rab$l_kbf = record; /* key buffer */
inrab.rab$b_ksz = KEY_SIZE; /* set key length */

/* Get and display the next-to-last record */
status = sys$get (&inrab);
if (! (status & 1))
    error_exit (status, inrab.rab$l_stv);
record[inrab.rab$w_rsz] = '\0';
printf ("Record: {%s}\n", record);

/* Close file */
status = sys$close (&infab);
if (! (status & 1))
    error_exit (status, infab.fab$l_stv);
}

```

You can use the Find service (similar to the Get service), in sequential access mode, random access by RFA mode, or random access by key access mode. When finding records in random access by key access mode, your program can specify any one of the four types of key matches (exact, generic, approximate, generic/approximate) described in Section 2.1.1.2 and Section 8.4.3.2.

In addition to reading, writing, and finding a record, your program can delete or update any record in an indexed file if the operation does not violate specified key characteristics. For example, if the program specifies that key values cannot be changed, any update that attempts to change a key value is rejected.

## Record Processing

### 8.4 Record Access for the Various File Organizations

The next section describes how indexed files are used with the sequential and random access by key modes.

#### 8.4.3.1 Sequential Access

You can use sequential record access mode to retrieve successive records in an indexed file. RMS retrieves the records in successive order by the specified sort order for a key of reference. The key of reference (for example, primary key, first alternate key, second alternate key, and so forth) is established through one of the following services:

- The Connect service.
- The Rewind service.
- The Find service or the Get service using random access. (Note that a Get or Put service specifying random access by RFA always establishes the key of reference as the primary key.)

When the sequential access mode is used with the Put service to insert records into an indexed file, successive records must be in the specified sort order by primary key.

#### 8.4.3.2 Random Access

One of the most useful features of indexed files is that you can randomly retrieve records by the record's key value. A key value and a key of reference (such as a primary key, first alternate key, and so forth) can be specified as input to the record-processing service. RMS searches the specified index to locate the record with the specified key value.

When reading records in random access by key mode, your program may specify one of four types of key matches:

- Exact key match
- Approximate key match
- Generic key match
- Approximate and generic key match

Exact match requires that the record's key value precisely match the key value specified by the program's Get service.

Approximate key match allows the program to select one of the following options:

- Equal-or-next-key option
- Next-key option
- Reverse equal-or-next-key option
- Reverse next-key option

The advantage of using an approximate key match is that your program can retrieve a record without knowing its precise key value. RMS uses the approximations in your program to return the record with the key value nearest the specified value.

If you elect to use a generic key match, your program need provide only a specified number of leading characters in the key, for example, the first 5 bytes (characters) of a 10-byte string data-type key.

## Record Processing

### 8.4 Record Access for the Various File Organizations

---

#### Note

---

The string data-type keys include `STRING`, `DSTRING`, `COLLATED`, and `DCOLLATED` keys.

---

RMS uses this information to return the first record with a key value that begins with these characters and meets the specified sorting order requirement. This is useful when attempting to locate a record when only part of the key is known or for applications in which a series of records must be retrieved when only the initial portions of their key values are identical. Generic key match is available for string keys only.

For example, if the program specifies the next-key option with a generic match on the three characters *RAM* using ascending sort order, RMS returns records with key values *RAMA*, *RAMBO*, and *RAMP* in that order. A record having the same key value *RAM* is not returned. If you specify the next-key option and descending sort order, RMS returns records with key values *RAMP*, *RAMBO*, and *RAMA* in that order.

When a generic key match is used with various approximate key match options, the results can vary, as shown in the following example. Consider using a key value of *ABB* to access records having key values of *ABA*, *ABB*, and *ABC*, respectively.

- If the program elects to use the equal-or-next-key option with ascending sort order and a 3-character generic match, RMS returns the record containing the key *ABB*.
- If the program uses the next-key option with ascending sort order and a 3-character generic match, RMS returns the record with key value *ABC*.
- If the program uses the equal-or-next-key option with ascending sort order and a 2-character generic match, RMS returns the record with key value *ABA*.

Now observe the effects of varying the search key option and the length of the generic string.

- If the program uses the next-key option with descending sort order and a 3-character generic match, RMS again returns the record with key value *ABA*.
- If the program uses the next-key option with descending sort order and a 2-character generic match (*AB*), RMS returns a record-not-found condition because none of the records has a key that begins with the letters *AA*.

Now consider an example of how to return all the records in a file with key values that match the generic string *AB*.

1. Specify the generic string value of *AB* (2-byte key) in random access by key mode.
2. Use the Get service (or the Find services) to access the first record.
3. Change the record access mode to sequential.
4. Access the next record.
5. Compare the first two characters of the returned record's key with the first two characters of the specified key.

## Record Processing

### 8.4 Record Access for the Various File Organizations

6. If the two key values are the same, process the record and return to step 4. If the two keys differ, do not process the record; instead, proceed to the next task (may require changing back to random access by key).

This procedure can be used to return all records that match a specified duplicate key for a key that allows duplicates. An alternative to checking the characters is to specify an ending key value and set the key-limit option when the record access mode is changed to sequential.

When accessing an indexed file randomly by key, the key value must reside in the area of memory identified by the control block offset RAB\$L\_KBF. When using string keys, you should specify the key length in the location identified by control block offset RAB\$B\_KSZ.

#### 8.4.4 Access by Record File Address (RFA)

Random access by RFA is supported for all disk files. Whenever RMS successfully accesses a record, an internal representation of the record's location is returned in the 6-byte RAB field RAB\$W\_RFA. When a program wants to retrieve the record using random access by RFA, RMS uses this internal data to retrieve the record.

One way to use RFA access is to establish a record position for later sequential accesses. Consider a sequential file with variable-length records that can only be accessed randomly using RFA access. Assume the file consists of a list of transactions, sorted previously by account value. Because each account may have multiple transactions, each account value may have multiple records for it in the file. Instead of reading the entire file until it finds the first record for the desired account number, it uses a previously saved RFA value and random access by RFA to set the current-record position using a Find service at the first record of the desired account number. It can then switch to sequential record access and read all successive records for that account, until the account number changes or the end of the file is reached. Figure 8–1 shows how the file is accessed for account C.

Figure 8–1 Using RFA Access to Establish Record Position

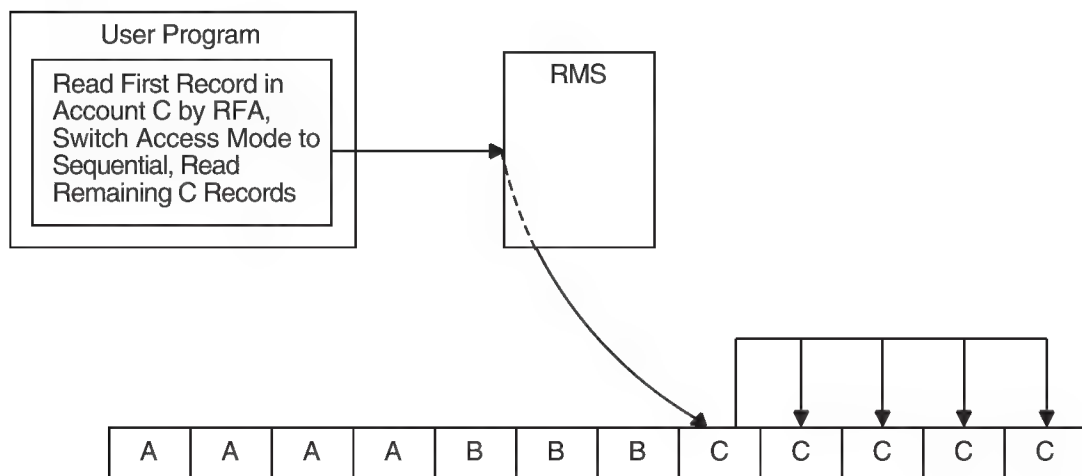

ZK-0753-GE

## 8.5 Block Input/Output

Block input/output (I/O) lets you bypass the record-processing capabilities entirely. In this manner, your program can process a file as a virtually contiguous set of blocks.

Block I/O operations provide an intermediate step between operations and direct use of the Queue I/O Request system service. Using block I/O gives your program full control of the data in the individual blocks of a file while being able to take advantage of the RMS capabilities for opening, closing, and extending a file.

In block I/O, a program reads or writes one or more blocks by specifying a starting virtual block number in the file and the length of the transfer. Regardless of the organization of the file, RMS accesses the identified block or blocks.

Because RMS files contain internal information meaningful only to RMS itself, Compaq does not recommend that you modify an existing file using block I/O if the file is also to be accessed by record-level operations. (Block I/O does not update any internal record information.) The block I/O facility, however, does allow you to create your own file organizations. This file structure must be maintained through specialized user-written programs and procedures; RMS cannot access these structures with its record access modes.

For more information about using block I/O, see the *OpenVMS Record Management Services Reference Manual*.

## 8.6 Current Record Context

For each RAB connected to a FAB, RMS maintains current context information about the record stream including the current-record position and the next-record position. Furthermore, the current context is different for the various services, as shown in Table 8–3.

The current record context is internal to RMS; you have no direct contact with it. However, you should know the context for each service in order to properly access records when you invoke a service.

**Table 8–3 Record Access Stream Context**

| Service                                       | Access Mode    | Current            | Next                    |
|---|----------------|--------------------|-------------------------|
| Connect                                       | Not applicable | None               | First record            |
| Connect with RAB\$L_ROP<br>RAB\$V_EOF bit set | Not applicable | None               | End of file             |
| Get, when last service<br>was not a Find      | Sequential     | Old next<br>record | New current<br>record+1 |
| Get, when last service<br>was a Find          | Sequential     | Unchanged          | Current<br>record+1     |
| Get   | Random         | New                | New current<br>record+1 |
| Put, sequential file                          | Sequential     | None               | End of file             |
| Put, relative file                            | Sequential     | None               | Next record<br>position |
| Put, indexed file                             | Sequential     | None               | Undefined               |

(continued on next page)

## Record Processing

### 8.6 Current Record Context

**Table 8–3 (Cont.) Record Access Stream Context**

| Service  | Access Mode    | Current         | Next                 |
|----------|----------------|-----------------|----------------------|
| Put      | Random         | None            | Unchanged            |
| Find     | Sequential     | Old next record | New current record+1 |
| Find     | Random         | New             | Unchanged            |
| Update   | Not applicable | None            | Unchanged            |
| Delete   | Not applicable | None            | Unchanged            |
| Truncate | Not applicable | None            | End of file          |
| Rewind   | Not applicable | Unchanged       | First record         |
| Free     | Not applicable | None            | Unchanged            |
| Release  | Not applicable | None            | Unchanged            |

Notes to Table 8–3:

1. Except for the Truncate service, RMS establishes the current-record position before establishing the next-record position.
2. The notation “+1” indicates the next sequential record as determined by the file organization. For indexed files, the current key of reference is part of this determination.
3. The Connect service on an indexed file establishes the next record to be the first record in the index represented by the RAB key of reference (RAB\$B\_KRF) field.
4. The Connect service leaves the next record as the end of file for a magnetic tape file opened for Put services (unless the FAB\$V\_NEF option in the FAB\$L\_FOP is set).

#### 8.6.1 Current-Record Position

For the Update, Delete, Release, and Truncate services, the current-record position reflects the location of the target record. The current-record position also facilitates sequential processing on disk devices for a stream.

The following list describes situations where the current-record position is undefined:

- When a RAB is first connected to a FAB
- When a record operation is unsuccessful
- Following the successful execution of a service other than a Get service or Find service

When the current-record position is undefined, RMS rejects the Update, Delete, Release, or Truncate service.

A Get service using sequential record access mode and immediately preceded by the Find service operates on the record specified by the current-record position. If the Find service does not lock the record (for relative and indexed files) and the current record is deleted, the Get service accesses the record at the next-record position.

Following successful execution of the Get service or the Find service, the current-record position is set to the target record's RFA. RMS also places the target record's address in the RFA field of the related RAB. The results are as follows:

- After initialization, the current-record position reflects the RFA of the record that was the object of the most recent successful Get service or Find service (unless a failure occurs on a different service).
- Unless it is modified, the RAB\$W\_RFA field always contains the address of the target current record. (If the operation fails, the RFA is undefined.)

Table 8–3 summarizes the effect that each successful record operation has on the context of the current record.

### 8.6.2 Next-Record Position

RMS uses the next-record position for doing sequential record access. For sequential record processing, the next-record position is the location of the target record for the next Find service (Get service where appropriate) or Put service. In a relative file, the target record is the record that occupies the next nonvacant cell.

The ability to look ahead significantly decreases access time for sequential processing. RMS uses its internal knowledge of file organization and structures to determine the next-record position for each record service.

The Connect service initializes the next-record position to one of the following locations:

- The first record in a sequential file or the first cell in a relative file
- The first record in the collated sequence of the specified key of reference in an indexed file
- The end of a file on disk, if the RAB\$L\_ROP field RAB\$V\_EOF option is set
- The end of a write-accessed ANSI magnetic tape file, unless the FAB\$V\_NEF option is set in the FAB\$L\_FOP field

In any record access mode, the Get service establishes the next-record position as either the next record or the next record cell in the file. This is also true for the Find service in sequential access mode.

The Truncate service establishes the end of the file at the current-record position (effectively deleting the record at that location and all records following it) so you need only use Put services to extend the file. Note that you can truncate only sequential files.

In random access mode, the Find (or Get) service and the Put service do not affect the next-record position, unless these services are used to add a record with a primary key value or a record number that lies between the corresponding values of the current record and the next record (previous record for reverse search key options). When this occurs, the current-record position is changed to reflect the location of the added record; that is, records are added *after the current record*, not before the next record.

In sequential access mode, the Put service initializes the next-record position to the end of the file in a sequential file. In a relative file, the Put service initializes the next-record position to the next record or record cell. For sequential accesses to an indexed file, the Put service does not define the next-record position.

## Record Processing

### 8.6 Current Record Context

Regardless of access mode, the Delete, Update, Free, and Release services have no effect on the next-record position. For sequential and relative files, the Rewind service establishes the next-record position as the first record or record cell in the file, regardless of the access mode. For indexed files, the Rewind service always establishes the next-record position as the location of the first record for the current key of reference.

Any unsuccessful record operation has no effect on the next record.

### 8.7 Synchronous and Asynchronous Operations

Your program can handle record operations on a file in one of two ways: synchronously or asynchronously. When operating synchronously, the program issuing the record-operation request regains control only when the request is completely satisfied. Most high-level languages support synchronous operation only. In asynchronous operations, the program can regain control before the request is completely satisfied. You can specify record operations and file operations to be either synchronous or asynchronous for each record stream.

For instance, when reading a record from a file synchronously, the program regains control only after the record is passed to the program. In other words, the program waits until the record returns; no other processing for this program takes place during this read-and-return cycle. On the other hand, when reading a record asynchronously, the program might be able to regain control before the record is passed to the program. The program can thus use the time normally required for the record transfer between the file and memory to perform some other computations. Another record operation cannot be started on the same stream until the previous record operation is complete. However, record operations on other streams can be initiated.

Whether the program regains control before the record operation finishes depends on several factors. For example, the required record may already reside in the I/O buffer, or the operating system may schedule another process, thus possibly allowing a necessary I/O operation to be completed before the original program is rescheduled.

One factor to consider in the use of asynchronous record operations is that you must include a separate completion routine or a wait request in the issuing program. This routine (or wait request) is required to determine when the record operation is completed because the results of the operation are not available, and the next record operation for that stream cannot be initiated until the previous operation is concluded.

#### 8.7.1 Using Synchronous Operations

To declare a synchronous operation, you must clear the RAB\$V\_ASY option in the RAB\$L\_ROP field. Normally, you do not have to clear this option because it is already cleared (by default). However, if the RAB\$V\_ASY option had been set previously, then you must explicitly clear it.

Normally, you do not use success and error routines with synchronous operations. Instead, you test the completion status code for an error and change the flow of the program accordingly. However, if you use these routines, they are executed as asynchronous system traps (ASTs) before the service returns to your program (unless ASTs are disabled).

## Record Processing

### 8.7 Synchronous and Asynchronous Operations

User-mode AST routines may be executed before the completion of a synchronous record operation (see the *OpenVMS Record Management Services Reference Manual*). If an AST routine attempts to perform operations on a record stream that is being called from a non-AST level, it must be prepared to handle stream-activity errors (RMS\$\_RSA or RMS\$\_BUSY).

#### 8.7.2 Using Asynchronous Operations

To declare an asynchronous record operation, you must set the asynchronous (RAB\$\_ASY) option in the RAB\$\_L\_ROP field. You can switch between synchronous and asynchronous operations during processing of a record stream by setting or clearing the RAB\$\_ASY option on a per-operation basis.

You can specify completion routines to be executed as ASTs if success or error conditions occur. Within such routines, you can issue additional operations, but they should also be asynchronous. If they are not, all other asynchronous requests currently active in your program cannot have their completion routines executed until the synchronous operation completes.

If an asynchronous operation is not completed at the time of return from a call to a service, the completion status field of the RAB is 0, and a success status code of RMS\$\_PENDING is returned in Register 0. This status code indicates that the operation was initiated but is not yet complete.

---

#### Note

---

Never modify the contents of an RMS control block when an operation is in progress because the results are unpredictable.

---

If you issue a second record operation request for the same stream before a previous request is completed, you receive an RMS\$\_RSA or RMS\$\_BUSY error status code, indicating that the record stream is still active. This can also occur when an AST-level routine attempts to use an active record stream; the original I/O request may be synchronous or asynchronous. An additional error (RMS\$\_BUSY) can be encountered by attempting an operation using the same record stream (RAB) from an error or success routine when the main program is awaiting completion of the initial operation. In all cases, it is your responsibility to recognize this possibility and prevent the problem. Most problems can be prevented by using a Wait service. When the Wait service concludes, it returns control to your program.

Note that the Connect operation may be performed asynchronously. If the RAB\$\_ASY option is set, a Wait service should follow the Connect service to synchronize with the completion of the Connect service. Another technique is to use the Connect service synchronously and set the RAB\$\_ASY option at run time, after the Connect service.



---

## Run-Time Options

This chapter describes the way you specify run-time options and summarizes the run-time options available to you when opening files, connecting record streams, processing records, and closing files. The run-time options that apply to record processing and to opening and closing a file can usually be preset by file-open and record stream connection values. Some options can be selected after you open a file and connect a record stream.

Note that run-time options discussed in previous sections are only summarized in this chapter. Most of the material in this chapter relates to options not previously described in this document.

### 9.1 Specifying Run-Time Options

This section describes the way you use the Edit/FDL utility to specify run-time options that are available to your program through the FDL\$PARSE and FDL\$RELEASE routines. It also describes the use of language statements and OpenVMS RMS (hereafter referred to as RMS) to specify control block values.

You select RMS options by setting appropriate values in RMS control blocks within the data portion of your program. In many cases, you can select these values by using keywords available to you in the language OPEN statement for your application or by taking suitable default values. The values may be selected using keywords in your record and file description statements or they may be selected directly within the OPEN statement.

If your application is written in a language that does not provide keywords for the various features, you can usually select the options using the File Definition Language (FDL).

Predefined FDL attributes can be supplied to your program at run time using the FDL\$PARSE routine. This routine also returns the address of the record access block (RAB) to let your program subsequently change RAB values. Some RAB options are not available in FDL and can be set only by directly accessing RAB fields and subfields at run time. To invoke options after record stream connection, your program must have direct access to RMS control block fields using the address of the RAB and symbolic offsets into it.

#### 9.1.1 Using the Edit/FDL Utility

You can use the Edit/FDL utility to specify run-time attributes, such as adding a CONNECT attribute that is used to set a control block value when the FDL\$PARSE and FDL\$RELEASE routines are called by your program. These attributes preset the values available for opening a file and connecting a record stream.

## Run-Time Options

### 9.1 Specifying Run-Time Options

The following original FDL file was created with the Edit/FDL utility:

```
IDENT
"19-JUL-1994 14:57:37   OpenVMS FDL Editor"
SYSTEM
SOURCE                VMS

FILE
ORGANIZATION          indexed

RECORD
CARRIAGE_CONTROL      carriage_return
FORMAT                variable
SIZE                  0

AREA 0
ALLOCATION              8283
BEST_TRY_CONTIGUOUS   yes
BUCKET_SIZE           18
EXTENSION              2070

AREA 1
ALLOCATION              18
BEST_TRY_CONTIGUOUS   yes
BUCKET_SIZE           18
EXTENSION              18

KEY 0
CHANGES               no
DATA_AREA              0
DATA_FILL              100
DATA_KEY_COMPRESSION  yes
DATA_RECORD_COMPRESSION yes
DUPLICATES             no
INDEX_AREA             1
INDEX_COMPRESSION      yes
INDEX_FILL             100
LEVEL1_INDEX_AREA     1
PROLOG                 3
SEGO_LENGTH            9
SEGO_POSITION          0
TYPE                   string
```

Because the Edit/FDL utility does not include run-time attributes, you must add them to the FDL definition. You can specify run-time attributes by specifying the ACCESS, CONNECT and SHARING attributes. For example, if you want to add the CONNECT secondary attribute LOCK\_ON\_WRITE, you use the EDIT/FDL ADD command. This is illustrated in Example 9-1.

#### Example 9-1 Specifying Run-Time Attributes

OpenVMS FDL Editor

```
Add      to insert one or more lines into the FDL definition
Delete    to remove one or more lines from the FDL definition
Exit      to leave the FDL Editor after creating the FDL file
Help      to obtain information about the FDL Editor
```

- ❶ Invoke to initiate a script of related questions
- Modify to change existing line(s) in the FDL definition
- Quit to abort the FDL Editor with no FDL file creation
- Set to specify FDL Editor characteristics
- View to display the current FDL Definition

(continued on next page)

**Example 9–1 (Cont.) Specifying Run-Time Attributes**

```

2 Main Editor Function          (Keyword)[Help] : ADD
      Legal Primary Attributes
      ACCESS attributes set the run-time access mode of the file
      AREA x attributes define the characteristics of file area x
      CONNECT attributes set various VMS RMS run-time options
      DATE attributes set the data parameters of the file
      FILE attributes affect the entire VMS RMS data file
3 JOURNAL attributes set the journaling parameters of the file
      KEY y attributes define the characteristics of key y
      RECORD attributes set the non-key aspects of each record
      SHARING attributes set the run-time sharing mode of the file
      SYSTEM attributes document operating system-specific items
      TITLE is the header line for the FDL file
4 Enter Desired Primary      (Keyword)[FILE] : CONNECT
      Legal CONNECT Secondary Attributes
      ASYNCHRONOUS          yes/no NOLOCK          yes/no
      BLOCK IO              yes/no NONEXISTENT_RECORD yes/no
      BUCKET CODE          number READ_AHEAD      yes/no
      CONTEXT              number READ_REGARDLESS  yes/no
      END OF FILE          yes/no TIMEOUT_ENABLE  yes/no
      FAST_DELETE          yes/no TIMEOUT_PERIOD  number
      FILL_BUCKETS         yes/no TRUNCATE_ON_PUT  yes/no
      KEY_GREATER_EQUAL    yes/no TT_CANCEL_CONTROL_0 yes/no
5 KEY GREATER_THAN        yes/no TT_PROMPT          yes/no
      KEY_LIMIT            yes/no TT_PURGE TYPE AHEAD yes/no
      KEY_OF_REFERENCE     number TT_READ_NOECHO    yes/no
      LOCATE MODE          yes/no TT_READ_NOFILTER  yes/no
      LOCK_ON_READ         yes/no TT_UPCASE_INPUT   yes/no
      LOCK_ON_WRITE        yes/no UPDATE_IF         yes/no
      MANUAL_UNLOCKING     yes/no WAIT_FOR_RECORD   yes/no
      MULTIBLOCK COUNT     number WRITE_BEHIND     yes/no
      MULTIBUFFER_COUNT    number
6 Enter CONNECT Attribute   (Keyword)[-] : LOCK_ON_WRITE
7 CONNECT
      LOCK_ON_WRITE
8 Enter value for this Secondary (Yes/No)[-] : YES
      Resulting Primary Section
9 CONNECT
      LOCK_ON_WRITE          yes
10 Press RETURN to continue (^Z for Main Menu)
  
```

The following list describes the callouts used in Example 9–1:

- 1** This menu is the Main Editor Function menu. It displays the Edit/FDL utility commands you can use.
- 2** The ADD command displays the Legal Primary Attributes menu.
- 3** The Legal Primary Attributes menu shows the primary attributes. You can either add a new primary attribute or add a secondary attribute to an existing primary attribute. Initially, the FILE primary attribute is the default.

## Run-Time Options

### 9.1 Specifying Run-Time Options

- ④ The selection of the CONNECT primary attribute displays the Legal CONNECT Secondary Attributes. You could similarly select the ACCESS, FILE, or SHARING options instead of the CONNECT primary attribute to display the Legal Secondary Attributes for the selected primary attribute.
- ⑤ This menu shows all the CONNECT secondary attributes you can add to your FDL file.
- ⑥ Select the proper CONNECT secondary attribute (in this case, LOCK\_ON\_WRITE).
- ⑦ The Edit/FDL utility verifies that you have selected the secondary attribute.
- ⑧ Enter the value that you want the secondary attribute to have (for instance, *yes*).
- ⑨ The Edit/FDL utility verifies the value for the secondary attribute you have chosen.
- ⑩ Return to the main menu. If you choose to add another secondary attribute, you will notice that CONNECT is now the default.

The FDL file containing the CONNECT primary attribute with the WRITE\_BEHIND secondary attribute is shown in the following example:

```
IDENT
"19-JUL-1994 14:57:37   OpenVMS FDL Editor"
SYSTEM
      SOURCE                VMS
FILE
      ORGANIZATION          indexed
RECORD
      CARRIAGE_CONTROL      carriage_return
      FORMAT                 variable
      SIZE                   0
CONNECT
      WRITE_BEHIND          yes
AREA 0
      ALLOCATION              8283
      BEST_TRY_CONTIGUOUS   yes
      BUCKET_SIZE           18
      EXTENSION              2070
AREA 1
      ALLOCATION              18
      BEST_TRY_CONTIGUOUS   yes
      BUCKET_SIZE           18
      EXTENSION              18
```

|                         |  |        |
|-------------------------|--|--------|
| KEY 0                   |  |        |
| CHANGES                 |  | no     |
| DATA_AREA               |  | 0      |
| DATA_FILL               |  | 100    |
| DATA_KEY_COMPRESSION    |  | yes    |
| DATA_RECORD_COMPRESSION |  | yes    |
| DUPLICATES              |  | no     |
| INDEX_AREA              |  | 1      |
| INDEX_COMPRESSION       |  | yes    |
| INDEX_FILL              |  | 100    |
| LEVEL1_INDEX_AREA       |  | 1      |
| PROLOG                  |  | 3      |
| SEGO_LENGTH             |  | 9      |
| SEGO_POSITION           |  | 0      |
| TYPE                    |  | string |

### 9.1.2 Using Language Statements and RMS

Language statements such as OPEN may contain keywords, clauses, or other modifiers that correspond to the run-time attributes that are appropriate for opening files, connecting record streams, processing records, and closing files. Some languages use system-defined procedures in place of keywords and clauses. Some languages allow you to call a user-supplied routine (USEROPEN or USERACTION) to set control block values before opening the file.

For example, a user routine could be coded in VAX MACRO to take advantage of control block store macros. (For an example of a VAX BASIC USEROPEN routine, see Example 5–2.) Consult the corresponding language documentation for additional information.

With VAX MACRO, RMS control block macros allow you to establish control block values at assembly time and at run time using the same control block. (The assembly-time macros are placed in a data section of the program; the run-time macros are placed in a code section of the program.) Using VAX MACRO, control blocks are allocated within the program space at assembly time, and it may not be necessary to use the run-time macros because the program can move values to the control block fields using the instruction set. Other languages, however, may not allocate the control blocks within program storage.

If your program has access to the starting location of the control block (a record access block, for instance), the VAX MACRO assembly-time control block macro or the corresponding symbol definition (DEF) macro provides your program with certain symbolic offsets (symbols) that can be used to locate and identify the various fields in the control block. Some languages provide a means of making these symbols available to your program.

For additional information about using the control block macros and control block fields, refer to the *OpenVMS Record Management Services Reference Manual*.

## 9.2 Options Related to Opening and Closing Files

Before your program can access the records in a file, it must open the file and connect a record stream. When it finishes processing records and no longer requires access to that file, your program should close the file.

The options available for opening files, connecting record streams, and closing files include file access and file sharing options, file specification options, performance options, record access options, and options for:

- Adding records
- Acting on the file after it is closed (file disposition)

## Run-Time Options

### 9.2 Options Related to Opening and Closing Files

- Using indexed files
- Using magnetic tapes
- Performing nonstandard record processing
- Maintaining data reliability

#### 9.2.1 File Access and Sharing Options

As described in Chapter 7, the program must declare the desired file-access and file-sharing values before opening an existing file or creating a new file and must specify record-locking and buffering strategies when the file is opened. These options are summarized in the next table:

| Option         | Description   |
|----------------|---|
| File access    | Specifies the record operations that the current process performs: reading records, locating records, deleting records, adding new records, updating records, accessing blocks, and truncating the file. (For additional information, see Section 7.1.) You specify the file access values using the FDL ACCESS primary attribute or the FAB\$B_FAC field.  |
| File sharing   | Specifies the types of record operations that the current process allows other file accessors to perform: reading records, locating records, deleting records, adding new records, and updating records. You can also use file sharing to enable the current process to use multiple record streams (or ensure a read-only global buffer cache), operate on the file without record interlocking, or disallow all other accessors from accessing the file. You specify file sharing values using the SHARING primary attribute or the FAB\$B_SHR field. |
| Record locking | Allows you to provide record locking for a shared file under user control. By default, RMS automatically locks records, depending on the file access and file sharing values specified. (For additional information, see Section 7.2.) You specify the record locking values using the CONNECT primary attribute or using the record-processing options (RAB\$L_ROP) field <sup>1</sup> .   |

<sup>1</sup>Indicates an option that can be specified for each record-processing operation. For more information, see Section 9.3.

#### 9.2.2 File Specifications

As described in Chapter 4 and Chapter 6, the program should specify the specification for the file being opened (or created) and can also specify default file specifications. The file specifications are summarized in the following table:

| File Specification | Description   |
|--------------------|---|
| Primary            | Specifies the file specification to be used to locate the desired file(s). If any components of a file specification are omitted, RMS applies defaults but you should specify the primary file specification. <ul style="list-style-type: none"><li>• FDL: FILE NAME</li><li>• RMS: FAB\$L_FNA and FAB\$B_FNS</li></ul> |

## 9.2 Options Related to Opening and Closing Files

| File Specification | Description  |
|--------------------|--|
| Default            | <p>Specifies the default file specification to be used to fill any missing components not provided by the primary file specification. After applying these defaults, if any components are still missing, additional defaults are applied.</p> <ul style="list-style-type: none"> <li>• FDL: FILE DEFAULT_NAME</li> <li>• RMS: FAB\$L_DNA and FAB\$B_DNS</li> </ul>                                  |
| Related            | <p>Specifies a related file specification that is used to provide additional defaults when a related file is used. If the device or directory components are missing, RMS provides default values from the process-default device (SYS\$DISK) and the current process-default directory.</p> <ul style="list-style-type: none"> <li>• FDL: None</li> <li>• RMS: FAB\$L_NAM and NAM\$L_RLF</li> </ul> |

## 9.2.3 File Performance Options

A number of run-time options that open files and connect record streams can collectively improve application performance. Such options include the buffering options discussed in Chapter 7.

Two run-time performance options not discussed previously are particularly important when adding records to a file: extension size and window size.

## 9.2.3.1 Extension Size

If you intend to add records to the file, specify a reasonable default extension size to reduce the number of times the file is extended.

Use the Edit/FDL utility to calculate the correct extension size. The Edit/FDL utility uses your responses to assign an optimum value for the FDL attribute FILE EXTENSION. With multiple area files, the Edit/FDL utility assigns optimum values to the AREA EXTENSION attributes.

If you do not specify an extension size, RMS computes the size; however, this size may not be optimum.

If you decide to create an FDL file for defining an indexed file without using EDIT/FDL, you can approximate the value of the EXTENSION attributes. You do this by multiplying the number of records per bucket by the number of records that you intend to add to the file during a given period of time.

To see the current default extension size, use the DCL command SHOW RMS\_DEFAULT. To set the default buffer count, use the DCL command SET RMS\_DEFAULT/EXTEND\_QUANTITY=*n*, where *n* is the number of blocks per extension. The corresponding field is FAB\$W\_DEQ.

## 9.2.3.2 Window Size

If the file is extended repeatedly, the extensions may be scattered on the disk. Each extension is called an *extent*—a pointer to each extent resides in the file header. For retrieval purposes, the pointers are gathered together in a structure called a **window**. The default window size is 7 pointers, but you can establish the window size to contain as many as 127 pointers. You can also set the window size to -1, which makes a window that is just large enough to map the entire file.

## Run-Time Options

### 9.2 Options Related to Opening and Closing Files

When you access an extent whose pointer is not in the current window, the system has to read the file header and fetch the appropriate window. This is called a **window turn**, and it requires an I/O operation.

Window size is a run-time option. Many high-level languages include a clause that sets window size when a file is opened.

You can set the window size (FAB\$B\_RTV field) at run time with a VAX MACRO subroutine or with the FDL attribute FILE WINDOW\_SIZE.

You can increase the default window size for a specific volume by using the DCL commands MOUNT and INITIALIZE. However, using additional window pointers increases system overhead. The window size is charged to your buffered I/O byte count quota, and indiscriminate use of large windows may result in exceeding the buffered I/O byte count quota or may exhaust the system's nonpaged dynamic memory.

You can use the Backup utility (BACKUP) to avoid having too many extents. When you restore a file, BACKUP tries to write the file in one section of the disk. Although BACKUP does not necessarily create a contiguous copy of the file, it does reduce the number of extents. If you are regularly backing up the file, the number of extents is probably reasonable. For more information about BACKUP, see the *OpenVMS System Manager's Manual*.

Where disk space is available, you can reduce the number of extents by creating a new, contiguous version of the file using either the Convert utility (CONVERT) or the DCL command COPY/CONTIGUOUS. If neither of these conditions apply, a larger window size is the only option to use. For file maintenance information, see Chapter 10.

#### 9.2.3.3 Summary of Performance Options

The following table summarizes the run-time open and connect options that may affect performance:

| Option                                      | Description  |
|---|--|
| Asynchronous record processing <sup>1</sup> | Specifies that record I/O for this record stream is done asynchronously. See Section 8.7. <ul style="list-style-type: none"><li>• FDL: CONNECT ASYNCHRONOUS</li><li>• RMS: RAB\$L_ROP RAB\$V_ASY</li></ul>   |
| Deferred-write <sup>1</sup>                 | Allows records to be accumulated in a buffer and written only when the buffer is needed or when the file is closed. For use by all except nonshared sequential files. See Chapter 3. <ul style="list-style-type: none"><li>• FDL: FILE DEFERRED_WRITE</li><li>• RMS: FAB\$L_FOP FAB\$V_DFW</li></ul> |
| Default extension quantity                  | Specifies the number of blocks to be allocated to a file when more space is needed. <ul style="list-style-type: none"><li>• FDL: FILE EXTENSION</li><li>• RMS: FAB\$W_DEQ</li></ul>  |

<sup>1</sup>Indicates an option that can be specified for each record-processing operation. For more information, see Section 9.3.

## Run-Time Options

### 9.2 Options Related to Opening and Closing Files

| Option                   | Description  |
|--------------------------|--|
| Fast delete <sup>1</sup> | <p>Postpones certain internal operations associated with deleting indexed file records until the record is accessed again. This allows records to be deleted rapidly but may affect the performance of subsequent accessors reading the file.</p> <ul style="list-style-type: none"> <li>• FDL: CONNECT FAST_DELETE</li> <li>• RMS: RAB\$L_ROP RAB\$V_FDL</li> </ul> |
| Global buffer count      | <p>Specifies whether global buffers are used and the number to be used if the record stream is the first to connect to the file. See Section 7.3.</p> <ul style="list-style-type: none"> <li>• FDL: CONNECT GLOBAL_BUFFER_COUNT</li> <li>• RMS: FAB\$W_GBC</li> </ul>  |
| Locate mode <sup>1</sup> | <p>Allows the use of locate mode, not move mode, when reading records. See Section 7.3.</p> <ul style="list-style-type: none"> <li>• FDL: CONNECT LOCATE_MODE</li> <li>• RMS: RAB\$L_ROP RAB\$V_LOC</li> </ul>   |
| Multiblock count         | <p>Allows multiple blocks to be transferred into memory during a single I/O operation (for sequential files only). See Chapter 3 and Section 7.3.</p> <ul style="list-style-type: none"> <li>• FDL: CONNECT MULTIBLOCK_COUNT</li> <li>• RMS: RAB\$B_MBC</li> </ul>   |
| Number of buffers        | <p>Enables the use of multiple buffers for the buffer cache when used with indexed and relative files; when used with sequential files, enables the use of multiple buffers for the read-ahead and write-behind options. See Section 7.3.</p> <ul style="list-style-type: none"> <li>• FDL: CONNECT MULTIBUFFER_COUNT</li> <li>• RMS: RAB\$B_MBF</li> </ul>          |
| Read-ahead <sup>1</sup>  | <p>Alternates buffer use between two buffers when reading sequential files. See Chapter 2.</p> <ul style="list-style-type: none"> <li>• FDL: CONNECT READ_AHEAD</li> <li>• RMS: RAB\$L_ROP RAB\$V_RAH</li> </ul>   |
| Retrieval window size    | <p>Specifies the number of entries in memory for retrieval windows, which corresponds to the number of extents for a file.</p> <ul style="list-style-type: none"> <li>• FDL: FILE WINDOW_SIZE</li> <li>• RMS: FAB\$B_RTV</li> </ul>  |

<sup>1</sup>Indicates an option that can be specified for each record-processing operation. For more information, see Section 9.3.

## Run-Time Options

### 9.2 Options Related to Opening and Closing Files

| Option                    | Description   |
|---------------------------|---|
| Sequential access only    | Indicates that a sequential file may only be accessed sequentially. <ul style="list-style-type: none"><li>• FDL: FILE SEQUENTIAL_ONLY</li><li>• RMS: FAB\$L_FOP FAB\$V_SQO</li></ul>                        |
| Write-behind <sup>1</sup> | Alternates buffer use between two buffers when writing to sequential files. See Chapter 2. <ul style="list-style-type: none"><li>• FDL: CONNECT WRITE_BEHIND</li><li>• RMS: RAB\$L_ROP RAB\$V_WBH</li></ul> |

<sup>1</sup>Indicates an option that can be specified for each record-processing operation. For more information, see Section 9.3.

#### 9.2.4 Record Access Options

You can specify the record access for a record stream as sequential, random by key or record number, or random by RFA. (See Section 8.1.) The selected record access can be changed for each record processing operation. These options can be set using the RAB\$B\_RAC field, values RAB\$C\_SEQ, RAB\$C\_KEY, and RAB\$C\_RFA.

#### 9.2.5 Options for Adding Records

When adding records to a file, consider the open and connection options in the following table:

| Option                                  | Description  |
|---|--|
| Default extension quantity <sup>1</sup> | See Section 9.2.3.   |
| Deferred-write <sup>1</sup>             | See Section 9.2.3.   |
| End-of-file                             | After the record stream is connected, the record context is positioned to the end of the file. <ul style="list-style-type: none"><li>• FDL: CONNECT END_OF_FILE</li><li>• RMS: RAB\$L_ROP RAB\$V_EOF</li></ul>   |
| Retrieval window size <sup>1</sup>      | See Section 9.2.3.   |
| Revision data                           | The revision date and time and the revision number can be specified to be a value other than the actual revision date and time and revision number when the file is closed. These options must be set while the file is open and thus cannot be set using FDL. <ul style="list-style-type: none"><li>• FDL: Does not apply</li><li>• RMS: Revision Date and Time XAB</li></ul> |

<sup>1</sup>Indicates an option that can be specified for each record-processing operation. For more information, see Section 9.3.

## Run-Time Options

### 9.2 Options Related to Opening and Closing Files

| Option                       | Description   |
|------------------------------|---|
| Truncate on Put <sup>1</sup> | <p>When using sequential record access for sequential files only, the record to be written is the last record in the file, and RMS truncates the file just beyond that record.</p> <ul style="list-style-type: none"> <li>• FDL: CONNECT TRUNCATE_ON_PUT</li> <li>• RMS: RAB\$L_ROP RAB\$V_TPT</li> </ul>   |
| Update-if <sup>1</sup>       | <p>If you set this option and your program tries to replace an existing record while adding records randomly to a file, RMS modifies the existing record instead of replacing it. When using this option for indexed files, note that the file must <i>not</i> allow duplicates for the primary key. Use this option carefully with a shared file (see Section 8.1).</p> <ul style="list-style-type: none"> <li>• FDL: CONNECT UPDATE_IF</li> <li>• RMS: RAB\$L_ROP RAB\$V_UIF</li> </ul> |
| Write-behind <sup>1</sup>    | See Section 9.2.3.  |

<sup>1</sup>Indicates an option that can be specified for each record-processing operation. For more information, see Section 9.3.

#### 9.2.6 Options for Data Reliability

The following table lists the run-time file open options that apply to data reliability:

| Option      | Description   |
|-------------|---|
| Read-check  | <p>Specifies that transfers from volumes are to be checked by a read-compare operation, which effectively doubles the amount of disk I/O performed. This option is not available for all devices (see the <i>OpenVMS Record Management Services Reference Manual</i>.)</p> <ul style="list-style-type: none"> <li>• FDL: FILE READ_CHECK</li> <li>• RMS: FAB\$L_FOP FAB\$V_RCK</li> </ul> |
| Write-check | <p>Specifies that transfers to volumes are to be checked by a read-compare operation, which effectively doubles the amount of disk I/O performed. This option is not available for all devices (see the <i>OpenVMS Record Management Services Reference Manual</i>.)</p> <ul style="list-style-type: none"> <li>• FDL: FILE WRITE_CHECK</li> <li>• RMS: FAB\$L_FOP FAB\$V_WCK</li> </ul>  |

#### 9.2.7 Options for File Disposition

The run-time file open options that apply to file disposition are listed in the following table. These options can only be selected while the file is open.

## Run-Time Options

### 9.2 Options Related to Opening and Closing Files

| Option              | Description  |
|---------------------|--|
| Delete on close     | Deletes the file when it is closed. <ul style="list-style-type: none"><li>• FDL: CONNECT DELETE_ON_CLOSE</li><li>• RMS: FAB\$L_FOP FAB\$V_DLT</li></ul>  |
| Submit command file | Submits a sequential file as a batch command procedure to SYS\$BATCH when you close the file. <ul style="list-style-type: none"><li>• FDL: FILE SUBMIT_ON_CLOSE</li><li>• RMS: FAB\$L_FOP FAB\$V_SCF</li></ul> |
| Spool on close      | Prints a sequential file on SYS\$PRINT when you close the file. <ul style="list-style-type: none"><li>• FDL: FILE PRINT_ON_CLOSE</li><li>• RMS: FAB\$L_FOP FAB\$V_SPL</li></ul>                                |

#### 9.2.8 Options for Indexed Files

The following table lists the run-time options that apply to indexed file processing. For more information about processing indexed files, refer to Section 8.4.3.

| Option                         | Description  |
|--------------------------------|--|
| Fast delete <sup>1</sup>       | Postpones certain internal operations associated with deleting indexed file records until the record is accessed again. This allows records to be deleted rapidly, but it may degrade the performance of processes that read the file later. <ul style="list-style-type: none"><li>• FDL: CONNECT FAST_DELETE</li><li>• RMS: RAB\$L_ROP RAB\$V_FDL</li></ul>   |
| Key equal or next <sup>1</sup> | Returns the first record with a key value equal to the key you specified when locating or reading records. If RMS does not find a record with an equal key value, it returns the record with the next higher key value when ascending sort order is specified. When descending sort order is specified, RMS returns the next record with the next lower key value. <ul style="list-style-type: none"><li>• FDL: CONNECT KEY_GREATER_EQUAL</li><li>• RMS: RAB\$L_ROP RAB\$V_EQNXT</li></ul> |
| Next key <sup>1</sup>          | Returns the record with the next higher key value when you specify ascending sort order when locating or reading records. When you specify descending sort order, RMS returns the next record with the next lower key value. If you do not specify either this option or the equal-or-next-key option, RMS tries for a key match. <ul style="list-style-type: none"><li>• FDL: CONNECT KEY_GREATER_THAN</li><li>• RMS: RAB\$L_ROP RAB\$V_NXT</li></ul>                                     |

<sup>1</sup>Indicates an option that can be specified for each record-processing operation. For more information, see Section 9.3.

## 9.2 Options Related to Opening and Closing Files

| Option                    | Description   |
|---------------------------|---|
| Key of reference          | Permits you to specify which key to use for the current record stream when you process an indexed file with multiple keys. <ul style="list-style-type: none"> <li>FDL: CONNECT KEY_OF_REFERENCE</li> <li>RMS: RAB\$B_KRF</li> </ul>                               |
| Key buffer <sup>1</sup>   | Specifies key buffer that must contain the selected record's key when you are locating or reading records randomly. <ul style="list-style-type: none"> <li>FDL: None</li> <li>RMS: RAB\$L_KBF</li> </ul>  |
| Key size <sup>1</sup>     | Specifies that only a portion of the key be used to locate the selected record when you are locating or reading records with a string data-type key. <ul style="list-style-type: none"> <li>FDL: None</li> <li>RMS: RAB\$B_KSZ</li> </ul>                         |
| Limit key <sup>1</sup>    | Returns an alternate success status if the record key exceeds the specified key when you are locating or reading records sequentially. <ul style="list-style-type: none"> <li>FDL: CONNECT KEY_LIMIT</li> <li>RMS RAB\$L_ROP RAB\$V_LIM</li> </ul>                |
| Load buckets <sup>1</sup> | Uses the fill factor specified when the file was created. When you are adding records to an index file. By default, RMS fills buckets completely. <ul style="list-style-type: none"> <li>FDL: CONNECT FILL_BUCKETS</li> <li>RMS: RAB\$L_ROP RAB\$V_LOA</li> </ul> |

<sup>1</sup>Indicates an option that can be specified for each record-processing operation. For more information, see Section 9.3.

## 9.2.9 Options for Magnetic Tape Processing

The run-time file open and close options that apply to magnetic tape processing are listed in the following table:

| Option          | Description   |
|-----------------|---|
| Not end-of-file | Adds a record to a location other than at the end of the file. <ul style="list-style-type: none"> <li>FDL: FILE MT_NOT_EOF</li> <li>RMS: FAB\$L_FOP FAB\$V_NEF</li> </ul> |

## Run-Time Options

### 9.2 Options Related to Opening and Closing Files

| Option           | Description   |
|------------------|---|
| Current position | Positions the tape to the location immediately following the most recently closed file when you select this option when creating a file. <ul style="list-style-type: none"><li>• FDL: FILE MT_CURRENT_POSITION</li><li>• RMS: FAB\$L_FOP FAB\$V_POS</li></ul> |
| Rewind on Open   | Directs that the tape volume be rewound before it opens or creates the file. The rewind-on-open option overrides the current-position option. <ul style="list-style-type: none"><li>• FDL: FILE MT_OPEN_REWIND</li><li>• RMS: FAB\$L_FOP FAB\$V_RWO</li></ul> |
| Rewind on Close  | Directs that the tape volume be rewound before it closes the file. <ul style="list-style-type: none"><li>• FDL: FILE MT_CLOSE_REWIND</li><li>• RMS: FAB\$L_FOP FAB\$V_RWC</li></ul>   |

#### 9.2.10 Options for Nonstandard File Processing

The following table lists the run-time file open options that apply to nonstandard file processing:

| Option              | Description   |
|---------------------|---|
| Non-file-structured | Use this option when you want to process data from volumes created on systems other than Compaq systems. <ul style="list-style-type: none"><li>• FDL: FILE NON_FILE_STRUCTURED</li><li>• RMS: FAB\$L_FOP FAB\$V_NFS</li></ul>   |
| User file open      | Use this option if you want to use RMS only to open the file and you intend to access the contents of the file using Queue I/O Request system service calls. The system returns the I/O channel number in the FAB\$L_STV field. <ul style="list-style-type: none"><li>• FDL: FILE USER_FILE_OPEN</li><li>• RMS: FAB\$L_FOP FAB\$V_UFO</li></ul> |

### 9.3 Summary of Record Operation Options

This section briefly describes the options associated with the record retrieval services (Find and Get), the record insertion service (Put), the record modification service (Update), and the record deletion service (Delete).

### 9.3.1 Record Retrieval Options

The Find and Get services (or the equivalent language statements) can be used to locate and retrieve a record.

The options associated with the Find and Get services are summarized in the following table. These options can be set for *each* Find or Get service if the program can access the appropriate RAB control block fields. The RAB control block fields are preset by connect-time values or defaults and as a result of previous service calls.

| Option                         | Description   |
|--------------------------------|---|
| Asynchronous record processing | <p>Specifies that record I/O for this record stream is done asynchronously.</p> <ul style="list-style-type: none"> <li>• FDL: CONNECT ASYNCHRONOUS</li> <li>• RMS: RAB\$L_ROP RAB\$V_ASY</li> </ul>   |
| Do not lock record             | <p>Directs RMS not to lock the record for ensuing operations.</p> <ul style="list-style-type: none"> <li>• FDL: CONNECT NOLOCK</li> <li>• RMS: RAB\$L_ROP RAB\$V_NLK</li> </ul>   |
| Key buffer                     | <p>Specifies key buffer that must contain the desired record's key when you are locating or reading records randomly.</p> <ul style="list-style-type: none"> <li>• FDL: None</li> <li>• RMS: RAB\$L_KBF</li> </ul>  |
| Key equal or next              | <p>Returns the first record with a key value equal to the specified key when you are locating or reading records. If RMS does not find a record with an equal key value, it returns the record with the next higher key value when you specify ascending sort order. When you specify descending sort order, RMS returns the record with the next lower key value.</p> <ul style="list-style-type: none"> <li>• FDL: CONNECT KEY_GREATER_EQUAL</li> <li>• RMS: RAB\$L_ROP RAB\$V_EQNXT</li> </ul> |
| Next key                       | <p>Returns the record with the next higher key value when you specify ascending sort order when you are locating or reading records. When you specify descending sort order, RMS returns the record with the next lower key value.</p> <ul style="list-style-type: none"> <li>• FDL: CONNECT KEY_GREATER_THAN</li> <li>• RMS: RAB\$L_ROP RAB\$V_NXT</li> </ul>  |
| Key of reference               | <p>Specifies which key is used for current record stream for indexed files with multiple keys.</p> <ul style="list-style-type: none"> <li>• FDL: CONNECT KEY_OF_REFERENCE</li> <li>• RMS: RAB\$B_KRF</li> </ul>   |

## Run-Time Options

### 9.3 Summary of Record Operation Options

| Option                  | Description   |
|-------------------------|---|
| Key size                | <p>Specifies that all or part of the key be used when you are using a string key to locate or read records.</p> <ul style="list-style-type: none"> <li>• FDL: None</li> <li>• RMS: RAB\$B_KSZ</li> </ul>  |
| Limit key               | <p>Directs RMS, when locating or reading records sequentially, to return an alternate success status if the record key exceeds the specified key.</p> <ul style="list-style-type: none"> <li>• FDL: CONNECT KEY_LIMIT</li> <li>• RMS: RAB\$L_ROP RAB\$V_LIM</li> </ul>  |
| Locate mode             | <p>Specifies the locate mode, instead of the move mode. Applies to the Get service only.</p> <ul style="list-style-type: none"> <li>• FDL: CONNECT LOCATE_MODE</li> <li>• RMS: RAB\$L_ROP RAB\$V_LOC</li> </ul>   |
| Lock nonexistent record | <p>Indicates that RMS is to lock the record position at the location of the following record operation, regardless of whether a record exists at that location. Applies only to relative files.</p> <ul style="list-style-type: none"> <li>• FDL: CONNECT NONEXISTENT_RECORD</li> <li>• RMS: RAB\$L_ROP RAB\$V_NXR</li> </ul> |
| Lock for read           | <p>Locks record for reading and allows other readers (but no writers).</p> <ul style="list-style-type: none"> <li>• FDL: CONNECT LOCK_ON_READ</li> <li>• RMS: RAB\$L_ROP RAB\$V_REA</li> </ul>  |
| Lock for write          | <p>Locks record for writing and allows other readers (but no writers).</p> <ul style="list-style-type: none"> <li>• FDL: CONNECT LOCK_ON_WRITE</li> <li>• RMS: RAB\$L_ROP RAB\$V_RLK</li> </ul>   |
| Manual locking          | <p>Allows you to control record locking and unlocking manually.</p> <ul style="list-style-type: none"> <li>• FDL: CONNECT MANUAL_LOCKING</li> <li>• RMS: RAB\$L_ROP RAB\$V_ULK</li> </ul>   |
| Read ahead              | <p>Improves performance at the expense of additional memory for I/O buffers. For sequential access to sequential files only.</p> <ul style="list-style-type: none"> <li>• FDL: CONNECT READ_AHEAD</li> <li>• RMS: RAB\$L_ROP RAB\$V_RAH</li> </ul>  |

## Run-Time Options

### 9.3 Summary of Record Operation Options

| Option               | Description  |
|----------------------|--|
| Read regardless      | <p>Reads the specified record regardless of whether it is locked by another user.</p> <ul style="list-style-type: none"> <li>• FDL: CONNECT READ_REGARDLESS</li> <li>• RMS: RAB\$L_ROP RAB\$V_RRL</li> </ul>   |
| Record access        | <p>Specifies the way records are accessed: sequentially, randomly by key (indexed files), by record number (relative files), or randomly by RFA.</p> <ul style="list-style-type: none"> <li>• FDL: None</li> <li>• RMS: RAB\$B_RAC values, RAB\$C_SEQ, RAB\$C_KEY, RAB\$C_RFA</li> </ul>   |
| RFA                  | <p>Specifies the address of the desired record when records are accessed randomly by RFA (RAB\$B_RAC contains RAB\$C_RFA). This value is also returned by Find and Get services regardless of the type record access used.</p> <ul style="list-style-type: none"> <li>• FDL: None</li> <li>• RMS: RAB\$W_RFA</li> </ul>  |
| Record header buffer | <p>Contains the symbolic address of the record header buffer that contains the fixed portion of a VFC record. Applies to the Get service only.</p> <ul style="list-style-type: none"> <li>• FDL: None</li> <li>• RMS: RAB\$L_RHB</li> </ul>  |
| Timeout period       | <p>Specifies a timeout period after which an error is returned when you choose the wait-if-locked option. The number of seconds is specified by the CONNECT TIMEOUT_PERIOD or RAB\$B_TMO field to eliminate a potential deadlock.</p> <ul style="list-style-type: none"> <li>• FDL: CONNECT TIMEOUT_PERIOD</li> <li>• RMS: RAB\$L_ROP RAB\$V_TMO and RAB\$B_TMO</li> </ul> |
| User buffer address  | <p>Specifies the address of the user buffer that receives the record. Applies to the Get service only.</p> <ul style="list-style-type: none"> <li>• FDL: None</li> <li>• RMS: RAB\$L_UBF</li> </ul>  |

## Run-Time Options

### 9.3 Summary of Record Operation Options

| Option           | Description   |
|------------------|---|
| User buffer size | Specifies the maximum length of the user record buffer. Applies to the Get service only. <ul style="list-style-type: none"><li>• FDL: None</li><li>• RMS: RAB\$L_USZ</li></ul>  |
| Wait if locked   | Specifies that if the record is locked, RMS must wait until it is available; also allows use of the wait-timeout-period option. <ul style="list-style-type: none"><li>• FDL: CONNECT WAIT_FOR_RECORD</li><li>• RMS: RAB\$L_ROP RAB\$V_WAT</li></ul> |

#### 9.3.2 Put Service Options

The Put service (or equivalent language statement) adds a record to the file.

The options associated with the Put service are summarized in the following table. These options can be set for *each* Put service if the program can access the appropriate RAB control block fields. The RAB control block fields are preset by connect-time values or defaults and as a result of previous service calls.

| Option                         | Description   |
|--------------------------------|---|
| Asynchronous record processing | Specifies that record I/O for this record stream is done asynchronously. <ul style="list-style-type: none"><li>• FDL: CONNECT ASYNCHRONOUS</li><li>• RMS: RAB\$L_ROP RAB\$V_ASY</li></ul>   |
| Key buffer                     | Specifies key buffer that must contain the desired record's relative record number when adding records randomly to a relative file. <ul style="list-style-type: none"><li>• FDL: None</li><li>• RMS: RAB\$L_KBF</li></ul>                                     |
| Key size                       | Specifies a field that must have a value of 4 (the default value provided by RMS) when adding records to a relative file using random record access. <ul style="list-style-type: none"><li>• FDL: None</li><li>• RMS: RAB\$B_KSZ</li></ul>                    |
| Load buckets                   | Fills the buckets to the level specified when the file is created. The default is that buckets fill completely before a bucket split occurs. <ul style="list-style-type: none"><li>• FDL: CONNECT FILL_BUCKETS</li><li>• RMS: RAB\$L_ROP RAB\$V_LOA</li></ul> |

## Run-Time Options

### 9.3 Summary of Record Operation Options

| Option                | Description  |
|-----------------------|--|
| Read allowed          | <p>Allows the locked record being written to be read.</p> <ul style="list-style-type: none"> <li>• FDL: CONNECT LOCK_ON_WRITE</li> <li>• RMS: RAB\$L_ROP RAB\$V_RLK</li> </ul>   |
| Record access         | <p>Specifies the way records are added, sequentially according to ascending key value or relative record number, randomly by key (indexed files) or by record number (relative files), or randomly by RFA.</p> <ul style="list-style-type: none"> <li>• FDL: None</li> <li>• RMS: RAB\$B_RAC values, RAB\$C_SEQ, RAB\$C_KEY, RAB\$C_RFA</li> </ul>                             |
| Record header buffer  | <p>Contains the symbolic address of the record header buffer that contains the fixed portion of a VFC record. Applies to the Get service only.</p> <ul style="list-style-type: none"> <li>• FDL: None</li> <li>• RMS: RAB\$L_RHB</li> </ul>  |
| Record buffer address | <p>Specifies the address of the record buffer that contains the record to be written.</p> <ul style="list-style-type: none"> <li>• FDL: None</li> <li>• RMS: RAB\$L_RBF</li> </ul>   |
| Record buffer size    | <p>Specifies the size of the record contained in the record buffer to be written.</p> <ul style="list-style-type: none"> <li>• FDL: None</li> <li>• RMS: RAB\$W_RSZ</li> </ul>   |
| Timeout period        | <p>Specifies a timeout period after which an error is returned when you choose the wait-if-locked option. The number of seconds is specified by the CONNECT TIMEOUT_PERIOD or the RAB\$B_TMO field to eliminate a potential deadlock.</p> <ul style="list-style-type: none"> <li>• FDL: CONNECT TIMEOUT_PERIOD</li> <li>• RMS: RAB\$L_ROP RAB\$V_TMO and RAB\$B_TMO</li> </ul> |

## Run-Time Options

### 9.3 Summary of Record Operation Options

| Option          | Description   |
|-----------------|---|
| Truncate on Put | <p>Specifies that the file is truncated at the record being added. Requires sequential record access and only applies to sequential files.</p> <ul style="list-style-type: none"><li>• FDL: CONNECT TRUNCATE_ON_PUT</li><li>• RMS: RAB\$L_ROP RAB\$V_TPT</li></ul>  |
| Update-if       | <p>Turns the Put service into an update operation if the record already exists in the file. Care must be taken when using this option with shared files and automatic record locking (see Section 8.1). When using this option with indexed files, note that the file must not allow duplicates for the primary key. This option can only be used when random record access has been specified.</p> <ul style="list-style-type: none"><li>• FDL: CONNECT UPDATE_IF</li><li>• RMS: RAB\$L_ROP RAB\$V_UIF</li></ul> |
| Write-behind    | <p>Improves performance at the expense of additional memory for I/O buffers. Requires sequential record access and only applies to sequential files.</p> <ul style="list-style-type: none"><li>• FDL: CONNECT WRITE_BEHIND</li><li>• RMS: RAB\$L_ROP RAB\$V_WBH</li></ul>   |

#### 9.3.3 Record Update Options

The Update service (or equivalent language statement) modifies an existing record in a file. Your program must first locate the appropriate record position and optionally retrieve the record itself by calling the Find or Get service (or equivalent language statement).

The options associated with the Update service are summarized in the following table. These options can be set for *each* Update service if the program can access the appropriate RAB control block fields. The RAB control block fields are preset by connect-time values or defaults and as a result of previous service calls.

| Option                         | Description  |
|--------------------------------|--|
| Asynchronous record processing | <p>Specifies that record I/O for this record stream is done asynchronously.</p> <ul style="list-style-type: none"><li>• FDL: CONNECT ASYNCHRONOUS</li><li>• RMS: RAB\$L_ROP RAB\$V_ASY</li></ul>   |
| Record header buffer           | <p>Contains the symbolic address of the record header buffer that contains the fixed portion of a VFC record. Applies to the Get service only.</p> <ul style="list-style-type: none"><li>• FDL: None</li><li>• RMS: RAB\$L_RHB</li></ul> |

## Run-Time Options

### 9.3 Summary of Record Operation Options

| Option                | Description  |
|-----------------------|--|
| Record buffer address | <p>Specifies the address of the record buffer that contains the record to be written.</p> <ul style="list-style-type: none"> <li>• FDL: None</li> <li>• RMS: RAB\$L_RBF</li> </ul> |
| Record buffer size    | <p>Specifies the size of the records contained in the record buffer to be written.</p> <ul style="list-style-type: none"> <li>• FDL: None</li> <li>• RMS: RAB\$W_RSZ</li> </ul>    |

#### 9.3.4 Record Deletion Options

The Delete service (or equivalent language statement) removes a record from the file. You cannot use this service for sequential files; however, a sequential file can be truncated using the Truncate service. Like the Update service, the Delete service must be preceded by a Find or Get service to establish the current record position.

The options associated with the Delete service are summarized in the following table. These options can be set for *each* Delete service if the program can access the appropriate RAB control block fields. The RAB control block fields are preset by connect-time values or defaults and as a result of previous service calls.

| Option                         | Description  |
|--------------------------------|--|
| Asynchronous record processing | <p>Specifies that record I/O for this record service will be asynchronous.</p> <ul style="list-style-type: none"> <li>• FDL: CONNECT ASYNCHRONOUS</li> <li>• RMS: RAB\$L_ROP RAB\$V_ASY</li> </ul>   |
| Fast delete                    | <p>Specifies that the record to be deleted is flagged as deleted, but parts of any alternate index key path are not completely erased until a subsequent access using the alternate key occurs. This makes deleting the record occur more quickly, but it requires additional access time for a subsequent Find or Get service.</p> <ul style="list-style-type: none"> <li>• FDL: CONNECT FAST_DELETE</li> <li>• RMS: RAB\$L_ROP RAB\$V_FDL</li> </ul> |

## Run-Time Options

### 9.4 Run-Time Example

### 9.4 Run-Time Example

Example 9–2 shows how to invoke the FDL\$PARSE and FDL\$RELEASE routines to use the predefined control block values set by an Edit/FDL utility editing session.

#### Example 9–2 Using the FDL\$PARSE and FDL\$RELEASE Routines

```

;
; This program calls the FDL utility routines FDL$PARSE and
; FDL$RELEASE. First, FDL$PARSE parses the FDL specification
; PART.FDL. Then the data file named in PART.FDL is accessed
; using the primary key. Last, the control blocks allocated
; by FDL$PARSE are released by FDL$RELEASE.
;
; .TITLE  FDLEXAM
;
; .PSECT  DATA,WRT,NOEXE
;
;
MY_FAB:      .LONG  0
MY_RAB:      .LONG  0
FDL FILE:    .ASCID  /PART.FDL/          ; Declare FDL file
REC_SIZE=80
LF=10
REC_RESULT:  .LONG  REC_SIZE
              .ADDRESS REC_BUFFER
REC_BUFFER:  .BLKB  REC_SIZE
HEADING:     .ASCID /ID PART SUPPLIER     COLOR /LF
;
; .PSECT  CODE
;
; Declare the external routines
;
.EXTRN       FDL$PARSE, -
              FDL$RELEASE
;
.ENTRY       FDLEXAM, ^M<>                ; Set up entry mask
              PUSHAL MY_RAB                ; Get set up for call with
              PUSHAL MY_FAB                ; addresses to receive the
              PUSHAL FDL FILE              ; FAB and RAB allocated by
              CALLS #3,G^FDL$PARSE         ; FDL$PARSE
              BLBS R0,KEY0                 ; Branch on success
              BRW ERROR                    ; Signal error
;
KEY0:        MOVL MY_FAB,R10                ; Move address of FAB to R10
              MOVL MY_RAB,R9                ; Move address of RAB to R9
              MOVL #REC_SIZE,RAB$W_USZ(R9)
              MOVAB REC_BUFFER,RAB$L_UBF(R9)
              $OPEN FAB=(R10)              ; Open the file
              BLBC R0,F_ERROR
              $CONNECT RAB=(R9)            ; Connect to the RAB
              BLBC R0,R_ERROR
              PUSHAQ HEADING               ; Display the heading
              CALLS #1,G^LIB$PUT_OUTPUT
              BLBC R0,ERROR
              BRB GET_REC                  ; Skip error handling
;

```

(continued on next page)

## Run-Time Options 9.4 Run-Time Example

### Example 9-2 (Cont.) Using the FDL\$PARSE and FDL\$RELEASE Routines

```

F_ERROR:      BRW      FAB_ERROR
R_ERROR:      BRW      RAB_ERROR

GET_REC:      $GET     RAB=(R9)           ; Get a record
              Cmpl     #RMS$EOF,R0      ; If not end of file,
              BEQLU   CLEAN            ; continue
              BLBC    R0,R_ERROR
              MOVZWL  RAB$W_RSZ(R9),REC_RESULT ; Move a record into
              PUSHAL  REC_RESULT        ; the buffer
              CALLS   #1,G^LIB$PUT_OUTPUT ; Display the record
              BLBC    R0,ERROR
              BRB     GET_REC           ; Get another record

CLEAN:        $CLOSE   FAB=(R10)        ; Close the FAB
              BLBC    R0,FAB_ERROR
              PUSHAL  MY_RAB            ; Push RAB address on stack
              PUSHAL  MY_FAB            ; Push FAB address on stack
              CALLS   #2,G^FDL$RELEASE  ; Release the control blocks
              BLBC    R0,ERROR
              BRB     FINI              ; Successful completion

FAB_ERROR:    PUSHL   FAB$L_STV(R10)    ; Signal file error
              PUSHL   FAB$L_STS(R10)
              BRB     RMS_ERR

ERROR:        PUSHL   R0                 ; Signal error
              CALLS   #1,G^LIB$SIGNAL
              $CLOSE  FAB=(R10)
              BRW     FINI              ; End program

RAB_ERROR:    PUSHL   RAB$L_STV(R9)     ; Signal record error
              PUSHL   RAB$L_STS(R9)

RMS_ERR:      CALLS   #2,G^LIB$SIGNAL

FINI:         RET
              .END  FDLEXAM

```



Designing and creating your files and defining their records are only the first steps in the life cycle of your file. You must also consider maintaining the file.

This chapter describes file maintenance with the emphasis on file tuning.

Section 10.1 describes how you can use the Analyze/RMS\_File utility to view the characteristics of a file. Section 10.2 describes how you can create an FDL file from a data file using the Analyze/RMS\_File utility. Section 10.3 explains how to use the Edit/FDL utility, particularly with Analyze/RMS\_File, to optimize and redesign file characteristics. Section 10.4 describes how to make a file contiguous. Section 10.5 explains how to reorganize a file, and Section 10.6 describes how to make archive copies of a file.

## 10.1 Viewing File Characteristics

The Analyze/RMS\_File utility (ANALYZE/RMS\_FILE) allows you to inspect and analyze the internal structure of an OpenVMS RMS (hereafter referred to as RMS) file.

ANALYZE/RMS\_FILE can check a file's structure for errors and can generate a statistical or summary report. A summary report is identical to a statistical report except that no checking is done. For more information on producing a summary report, see the description of the Analyze/RMS\_File utility in the *OpenVMS Record Management Utilities Reference Manual*.

You can also inspect and analyze your file using the Analyze/RMS\_File utility interactively. The analysis can show whether or not the file is properly designed for its application and can point out ways to improve the file design.

In addition, you can use ANALYZE/RMS\_FILE to obtain FDL files from data files. You can then use these FDL files with the Create/FDL utility (CREATE/FDL), the Convert utility (CONVERT), and the Edit/FDL utility, (EDIT/FDL). FDL files created with ANALYZE/RMS\_FILE contain special analysis sections for each area and key, which are called ANALYSIS\_OF\_AREA and ANALYSIS\_OF\_KEY. The Edit/FDL utility uses these sections in the Optimize script to tune the file's structure.

### 10.1.1 Performing an Error Check

To check a file's structure for errors, use the following command syntax:

```
ANALYZE/RMS_FILE/CHECK filespec
```

By default with a command of this format, the Check report is displayed on the terminal (SYS\$OUTPUT).

## Maintaining Files

### 10.1 Viewing File Characteristics

If you receive any error messages, the file has been corrupted by a serious error. If you have had a hardware problem such as a power failure or a disk head failure, then the hardware probably caused the corruption. If you have not had any hardware problems, then a software error may have caused the corruption. Note that the /CHECK qualifier does not find all types of file corruption, however.

In either case, you can try using the Convert utility to fix the problem by using the file specification as both the **input-filespec** and the **output-filespec**. Note that if you are processing a relative file containing deleted or unused records, the conversion process changes relative record numbers (RRN) in the output file. If the conversion does not correct the problem, use the Backup utility (BACKUP) to bring in the backup copy of the file.

For more information about CONVERT and BACKUP, see Section 10.4.2, Section 10.5, and Section 10.6.

---

#### Note

---

If you believe that the software caused the error, contact a Compaq support representative. Supply the ANALYZE/RMS\_FILE check report, a copy of the data file, and a description of what was done with the data file. If possible, also supply a version of the file prior to the corruption and the program or procedure which led to the corruption; being able to reproduce the problem is of tremendous value.

---

Example 10-1 is a sample Check report of a file with the file specification DISK\$:[HERBER]CUSTDATA.DAT;2.

#### Example 10-1 Using ANALYZE/RMS\_FILE to Create a Check Report

```
Check RMS File Integrity                               14-JUN-1993 21:51:47.38   Page 1
DISK$:[HERBER]CUSTDATA.DAT;2
```

##### FILE HEADER

```
File Spec: DISK$:[HERBER]CUSTDATA.DAT;2
File ID: (10044,39,1)
Owner UIC: [011,310]
Protection: System: RWED, Owner: RWED, Group: RWE, World: RWE
Creation Date: 9-JUN-1993 22:30:24.78
Revision Date: 9-JUN-1993 22:30:30.86, Number: 4
Expiration Date: none specified
Backup Date: none posted
Contiguity Options: none
Performance Options: none
Reliability Options: none
Journaling Enabled: none
```

##### RMS FILE ATTRIBUTES

```
File Organization: indexed
Record Format: variable
Record Attributes: carriage-return
Maximum Record Size: 80
Blocks Allocated: 30, Default Extend Size: 2
Bucket Size: 1
File Monitoring: disabled
Global Buffer Count: 0
```

(continued on next page)

## Maintaining Files

### 10.1 Viewing File Characteristics

#### Example 10–1 (Cont.) Using ANALYZE/RMS\_FILE to Create a Check Report

```
FIXED PROLOG
    Number of Areas: 8, VBN of First Descriptor: 3
    Prolog Version: 3
AREA DESCRIPTOR #0 (VBN 3, offset %X'0000')
    Bucket Size: 1
    Reclaimed Bucket VBN: 0
    Current Extent Start: 1, Blocks: 9, Used: 4, Next: 5
    Default Extend Quantity: 2
    Total Allocation: 9
AREA DESCRIPTOR #1 (VBN 3, offset %X'0040')
    Bucket Size: 1
    Reclaimed Bucket VBN: 0
    Current Extent Start: 10, Blocks: 3, Used: 1, Next: 11
    Default Extend Quantity: 1
AREA DESCRIPTOR #2 (VBN 3, offset %X'0080')
    Bucket Size: 1
    Reclaimed Bucket VBN: 0
    Current Extent Start: 13, Blocks: 3, Used: 1, Next: 14
    Default Extend Quantity: 1
    Total Allocation: 3
AREA DESCRIPTOR #3 (VBN 3, offset %X'00C0')
    Bucket Size: 1
    Reclaimed Bucket VBN: 0
    Current Extent Start: 16, Blocks: 3, Used: 1, Next: 17
    Default Extend Quantity: 1
    Total Allocation: 3
AREA DESCRIPTOR #4 (VBN 3, offset %X'0100')
    Bucket Size: 1
    Reclaimed Bucket VBN: 0
    Current Extent Start: 19, Blocks: 3, Used: 1, Next: 20
    Default Extend Quantity: 1
    Total Allocation: 3
AREA DESCRIPTOR #5 (VBN 3, offset %X'0140')
    Bucket Size: 1
    Reclaimed Bucket VBN: 0
    Current Extent Start: 22, Blocks: 3, Used: 1, Next: 23
    Default Extend Quantity: 1
    Total Allocation: 3
AREA DESCRIPTOR #6 (VBN 3, offset %X'0180')
    Bucket Size: 1
    Reclaimed Bucket VBN: 0
    Current Extent Start: 25, Blocks: 3, Used: 1, Next: 26
    Default Extend Quantity: 1
    Total Allocation: 3
AREA DESCRIPTOR #7 (VBN 3, offset %X'01C0')
```

(continued on next page)

## Maintaining Files

### 10.1 Viewing File Characteristics

#### Example 10–1 (Cont.) Using ANALYZE/RMS\_FILE to Create a Check Report

```
Bucket Size: 1
Reclaimed Bucket VBN: 0
Current Extent Start: 28, Blocks: 3, Used: 1, Next: 29
Default Extend Quantity: 1
Total Allocation: 3
KEY DESCRIPTOR #0 (VBN 1, offset %X'0000')

Next Key Descriptor VBN: 2, Offset: %X'0000'
Index Area: 1, Level 1 Index Area: 1, Data Area: 0
Root Level: 1
Index Bucket Size: 1, Data Bucket Size: 1
Root VBN: 10
Key Flags:
    (0)  KEY$V_DUPKEYS      0
    (3)  KEY$V_IDX_COMPR   0
    (4)  KEY$V_INITIDX     0
    (6)  KEY$V_KEY_COMPR   0
    (7)  KEY$V_REC_COMPR   1

Key Segments: 1
Key Size: 4
Minimum Record Size: 4
Index Fill Quantity: 512, Data Fill Quantity: 512
Segment Positions:      0
Segment Sizes:          4
Data Type: string
Name: "PART_NUM"
First Data Bucket VBN: 4

KEY DESCRIPTOR #1 (VBN 2, offset %X'0000')

Next Key Descriptor VBN: 2, Offset: %X'0066'
Index Area: 3, Level 1 Index Area: 3, Data Area: 2
Root Level: 1
Index Bucket Size: 1, Data Bucket Size: 1
Root VBN: 16
Key Flags:
    (0)  KEY$V_DUPKEYS      1
    (1)  KEY$V_CHGKEYS     0
    (2)  KEY$V_NULKEYS     0
    (3)  KEY$V_IDX_COMPR   0
    (4)  KEY$V_INITIDX     0
    (6)  KEY$V_KEY_COMPR   0

Key Segments: 1
Key Size: 5
Minimum Record Size: 9
Index Fill Quantity: 512, Data Fill Quantity: 512
Segment Positions:      4
Segment Sizes:          5
Data Type: string
Name: "PART_NAME"
First Data Bucket VBN: 13
```

(continued on next page)

**Example 10–1 (Cont.) Using ANALYZE/RMS\_FILE to Create a Check Report**

```
KEY DESCRIPTOR #2 (VBN 2, offset %X'0066')
    Next Key Descriptor VBN: 2, Offset: %X'00CC'
    Index Area: 5, Level 1 Index Area: 5, Data Area: 4
    Root Level: 1
    Index Bucket Size: 1, Data Bucket Size: 1
    Root VBN: 22
    Key Flags:
        (0) KEY$V_DUPKEYS      1
        (1) KEY$V_CHGKEYS     0
        (2) KEY$V_NULKEYS     0
        (3) KEY$V_IDX_COMPR   1
        (4) KEY$V_INITIDX     0
        (6) KEY$V_KEY_COMPR   1
    Key Segments: 1
    Key Size: 10
    Minimum Record Size: 19
    Index Fill Quantity: 512, Data Fill Quantity: 512
    Segment Positions:      9
    Segment Sizes:         10
    Data Type: string
    Name: "SUPPLIER_NAME"
    First Data Bucket VBN: 19

KEY DESCRIPTOR #3 (VBN 2, offset %X'00CC')
    Index Area: 7, Level 1 Index Area: 7, Data Area: 6
    Root Level: 1
    Index Bucket Size: 1, Data Bucket Size: 1
    Root VBN: 28
    Key Flags:
        (0) KEY$V_DUPKEYS      1
        (1) KEY$V_CHGKEYS     0
        (2) KEY$V_NULKEYS     0
        (3) KEY$V_IDX_COMPR   1
        (4) KEY$V_INITIDX     0
        (6) KEY$V_KEY_COMPR   1
    Key Segments: 1
    Key Size: 10
    Minimum Record Size: 29
    Index Fill Quantity: 512, Data Fill Quantity: 512
    Segment Positions:     19
    Segment Sizes:        10
    Data Type: string
    Name: "COLOR"
    First Data Bucket VBN: 25
```

The analysis uncovered NO errors.

```
ANALYZE/RMS_FILE/OUTPUT=CUSTDATA.ANL CUSTDATA.DAT
```

To place the Check report in a file, use a command of the form:

```
ANALYZE/RMS_FILE/CHECK/OUTPUT=output-filespec input-filespec
```

The Check report will be placed in the file you named with the **output-filespec** parameter. This file will receive the file type .ANL by default. For example, the following command will perform an error check on PRLG2.IDX and place the Check report in the file ERROR.ANL:

```
$ ANALYZE/RMS_FILE/CHECK/OUTPUT=ERROR PRLG2.IDX
```

## Maintaining Files

### 10.1 Viewing File Characteristics

#### 10.1.2 Generating a Statistics Report

For indexed files, the Statistics report consists of the Check report plus additional information about the areas and keys in the file. (A Statistics report on a sequential or relative file is thus the same as a Check report.)

To generate a Statistics report with ANALYZE/RMS\_FILE, enter a DCL command of the form:

```
ANALYZE/RMS_FILE/STATISTICS filespec
```

Example 10–2 is an example of a Statistics report.

#### Example 10–2 Using ANALYZE/RMS\_FILE to Create a Statistics Report

```
RMS File Statistics                               18-APR-1993 11:22:27.14   Page 1
DISK$:[TEST.PROGRAM]INDEX.DAT;1
```

##### FILE HEADER

```
File Spec: DISK$:[TEST.PROGRAM]INDEX.DAT;1
File ID: (15960,8,0)
Owner UIC: [011,310]
Protection: System: RWED, Owner: RWED, Group: RWED, World: RWE
Creation Date: 19-APR-1993 22:15:55.70
Revision Date: 19-APR-1993 22:16:01.74, Number: 4
Expiration Date: none specified
Backup Date: 18-APR-1993 00:57:54.24
Contiguity Options: contiguous-best-try
Performance Options: none
Reliability Options: none
Journaling Enabled: none
```

##### RMS FILE ATTRIBUTES

```
File Organization: indexed
Record Format: variable
Record Attributes: carriage-return
Maximum Record Size: 80
Blocks Allocated: 30, Default Extend Size: 2
Bucket Size: 1
File Monitoring: disabled
Global Buffer Count: 0
```

##### FIXED PROLOG

```
Number of Areas: 8, VBN of First Descriptor: 3
Prolog Version: 3
```

##### AREA DESCRIPTOR #0 (VBN 3, offset %X'0000')

```
Bucket Size: 1
Reclaimed Bucket VBN: 0
Current Extent Start: 1, Blocks: 9, Used: 4, Next: 5
Default Extend Quantity: 2
Total Allocation: 9
```

##### STATISTICS FOR AREA #0

```
Count of Reclaimed Blocks: 0
```

##### AREA DESCRIPTOR #1 (VBN 3, offset %X'0040')

(continued on next page)

## Maintaining Files

### 10.1 Viewing File Characteristics

#### Example 10–2 (Cont.) Using ANALYZE/RMS\_FILE to Create a Statistics Report

```
Bucket Size: 1
Reclaimed Bucket VBN: 0
Current Extent Start: 10, Blocks: 3, Used: 1, Next: 11
Default Extend Quantity: 1
Total Allocation: 3

STATISTICS FOR AREA #1
Count of Reclaimed Blocks:          0

AREA DESCRIPTOR #2 (VBN 3, offset %X'0080')
Bucket Size: 1
Reclaimed Bucket VBN: 0
Current Extent Start: 13, Blocks: 3, Used: 1, Next: 14
Default Extend Quantity: 1
Total Allocation: 3

STATISTICS FOR AREA #2
Count of Reclaimed Blocks:          0

AREA DESCRIPTOR #3 (VBN 3, offset %X'00C0')
Bucket Size: 1
Reclaimed Bucket VBN: 0
Current Extent Start: 16, Blocks: 3, Used: 1, Next: 17
Default Extend Quantity: 1
Total Allocation: 3

STATISTICS FOR AREA #3
Count of Reclaimed Blocks:          0

AREA DESCRIPTOR #4 (VBN 3, offset %X'0100')
Bucket Size: 1
Reclaimed Bucket VBN: 0
Current Extent Start: 19, Blocks: 3, Used: 1, Next: 20
Default Extend Quantity: 1
Total Allocation: 3

STATISTICS FOR AREA #4
Count of Reclaimed Blocks:          0

AREA DESCRIPTOR #5 (VBN 3, offset %X'0140')
Bucket Size: 1
Reclaimed Bucket VBN: 0
Current Extent Start: 22, Blocks: 3, Used: 1, Next: 23
Default Extend Quantity: 1
Total Allocation: 3

STATISTICS FOR AREA #5
Count of Reclaimed Blocks:          0

AREA DESCRIPTOR #6 (VBN 3, offset %X'0180')
Bucket Size: 1
Reclaimed Bucket VBN: 0
Current Extent Start: 25, Blocks: 3, Used: 1, Next: 26
Default Extend Quantity: 1
Total Allocation: 3

STATISTICS FOR AREA #6
Count of Reclaimed Blocks:          0
```

(continued on next page)

## Maintaining Files

### 10.1 Viewing File Characteristics

#### Example 10-2 (Cont.) Using ANALYZE/RMS\_FILE to Create a Statistics Report

```
AREA DESCRIPTOR #7 (VBN 3, offset %X'01C0')
    Bucket Size: 1
    Reclaimed Bucket VBN: 0
    Current Extent Start: 28, Blocks: 3, Used: 1, Next: 29
    Default Extend Quantity: 1
    Total Allocation: 3
STATISTICS FOR AREA #7
    Count of Reclaimed Blocks:          0

KEY DESCRIPTOR #0 (VBN 1, offset %X'0000')
    Next Key Descriptor VBN: 2, Offset: %X'0000'
    Index Area: 1, Level 1 Index Area: 1, Data Area: 0
    Root Level: 1
    Index Bucket Size: 1, Data Bucket Size: 1
    Root VBN: 10
    Key Flags:
        (0) KEY$V_DUPKEYS      0
        (3) KEY$V_IDX_COMPR    0
        (4) KEY$V_INITIDX      0
        (6) KEY$V_KEY_COMPR    0
        (7) KEY$V_REC_COMPR    1
    Key Segments: 1
    Key Size: 4
    Minimum Record Size: 4
    Index Fill Quantity: 512, Data Fill Quantity: 512
    Segment Positions:          0
    Segment Sizes:              4
    Data Type: string
    Name: "ID_NUM"
    First Data Bucket VBN: 4

STATISTICS FOR KEY #0
    Number of Index Levels:          1
    Count of Level 1 Records:         1
    Mean Length of Index Entry:       6
    Count of Index Blocks:            1
    Mean Index Bucket Fill:           4%
    Mean Index Entry Compression:     0%

    Count of Data Records:           10
    Mean Length of Data Record:       33
    Count of Data Blocks:             1
    Mean Data Bucket Fill:            90%
    Mean Data Key Compression:        0%
    Mean Data Record Compression:    -2%

    Overall Space Efficiency:         2%
```

(continued on next page)

## Maintaining Files

### 10.1 Viewing File Characteristics

#### Example 10-2 (Cont.) Using ANALYZE/RMS\_FILE to Create a Statistics Report

```
KEY DESCRIPTOR #1 (VBN 2, offset %X'0000')
    Next Key Descriptor VBN: 2, Offset: %X'0066'
    Index Area: 3, Level 1 Index Area: 3, Data Area: 2
    Root Level: 1
    Index Bucket Size: 1, Data Bucket Size: 1
    Root VBN: 16
    Key Flags:
        (0) KEY$V_DUPKEYS      1
        (1) KEY$V_CHGKEYS     0
        (2) KEY$V_NULKEYS     0
        (3) KEY$V_IDX_COMPR   0
        (4) KEY$V_INITIDX     0
        (6) KEY$V_KEY_COMPR   0
    Key Segments: 1
    Key Size: 5
    Minimum Record Size: 9
    Index Fill Quantity: 512, Data Fill Quantity: 512
    Segment Positions:      4
    Segment Sizes:         5
    Data Type: string
    Name: "ID_NAME"
    First Data Bucket VBN: 13
```

#### STATISTICS FOR KEY #1

```
Number of Index Levels:      1
Count of Level 1 Records:    1
Mean Length of Index Entry:  7
Count of Index Blocks:      1
Mean Index Bucket Fill:     4%
Mean Index Entry Compression: 0%

Count of Data Records:      6
Mean Duplicates per Data Record: 0
Mean Length of Data Record: 19
Count of Data Blocks:      1
Mean Data Bucket Fill:     24%
Mean Data Key Compression:  0%
```

```
KEY DESCRIPTOR #2 (VBN 2, offset %X'0066')
    Next Key Descriptor VBN: 2, Offset: %X'00CC'
    Index Area: 5, Level 1 Index Area: 5, Data Area: 4
    Root Level: 1
    Index Bucket Size: 1, Data Bucket Size: 1
    Root VBN: 22
    Key Flags:
        (0) KEY$V_DUPKEYS      1
        (1) KEY$V_CHGKEYS     0
        (2) KEY$V_NULKEYS     0
        (3) KEY$V_IDX_COMPR   1
        (4) KEY$V_INITIDX     0
        (6) KEY$V_KEY_COMPR   1
    Key Segments: 1
    Key Size: 10
    Minimum Record Size: 19
    Index Fill Quantity: 512, Data Fill Quantity: 512
    Segment Positions:      9
    Segment Sizes:         10
    Data Type: string
    Name: "ADDRESS"
    First Data Bucket VBN: 19
```

(continued on next page)

## Maintaining Files

### 10.1 Viewing File Characteristics

#### Example 10–2 (Cont.) Using ANALYZE/RMS\_FILE to Create a Statistics Report

```
STATISTICS FOR KEY #2
    Number of Index Levels:          1
    Count of Level 1 Records:        1
    Mean Length of Index Entry:      12
    Count of Index Blocks:           1
    Mean Index Bucket Fill:          4%
    Mean Index Entry Compression:    58%

    Count of Data Records:           7
    Mean Duplicates per Data Record: 0
    Mean Length of Data Record:      20
    Count of Data Blocks:             1
    Mean Data Bucket Fill:           30%
    Mean Data Key Compression:       21%

KEY DESCRIPTOR #3 (VBN 2, offset %X'00CC')
    Index Area: 7, Level 1 Index Area: 7, Data Area: 6
    Root Level: 1
    Index Bucket Size: 1, Data Bucket Size: 1
    Root VBN: 28
    Key Flags:
        (0) KEY$V_DUPKEYS          1
        (1) KEY$V_CHGKEYS          0
        (2) KEY$V_NULKEYS          0
        (3) KEY$V_IDX_COMPR        1
        (4) KEY$V_INITIDX          0
        (6) KEY$V_KEY_COMPR        1

    Key Segments: 1
    Key Size: 10
    Minimum Record Size: 29
    Index Fill Quantity: 512, Data Fill Quantity: 512
    Segment Positions:      19
    Segment Sizes:          10
    Data Type: string
    Name: "CHARGES"
    First Data Bucket VBN: 25

STATISTICS FOR KEY #3
    Number of Index Levels:          1
    Count of Level 1 Records:        1
    Mean Length of Index Entry:      12
    Count of Index Blocks:           1
    Mean Index Bucket Fill:          4%
    Mean Index Entry Compression:    58%

    Count of Data Records:           5
    Mean Duplicates per Data Record: 1
    Mean Length of Data Record:      23
    Count of Data Blocks:             1
    Mean Data Bucket Fill:           25%
    Mean Data Key Compression:       34%
```

The analysis uncovered NO errors.

```
ANALYZE/RMS_FILE/OUTPUT=INDEX/STATISTICS INDEX.DAT
```

### 10.1.3 Using Interactive Mode

The `/INTERACTIVE` qualifier begins an interactive session in which you can examine the structure of an RMS file.

`ANALYZE/RMS_FILE` imposes a hierarchical tree structure on the internal RMS file structure. Each data structure in the file is a node, with a branch for each pointer in the data structure. The file header is always the root node. Each of the three file organizations (sequential, relative, and indexed) has its own tree structure.

To examine a file, you enter commands that move the current position to particular structures within the tree. The utility displays the current structure on the screen.

Table 10–1 summarizes the `ANALYZE/RMS_FILE` commands.

**Table 10–1 ANALYZE/RMS\_FILE Command Summary**

| Command            | Function  |
|--------------------|---|
| AGAIN              | Displays the current structure again.   |
| DOWN [branch]      | Moves the structure pointer down to the next level. If the current node has more than one branch, the branch keyword must be specified.<br><br>If a branch keyword is required but not specified, the utility will display a list of possibilities to prompt you. You can also display the list by specifying “DOWN ?.” |
| DUMP n             | Displays a hexadecimal dump of the specified block.   |
| EXIT               | Ends the interactive session.   |
| FIRST              | Moves the structure pointer to the first structure on the current level. The structure is displayed. For example, if you are examining data buckets and want to examine the first bucket, this command will put you there and display the first bucket’s header.  |
| HELP [keyword ...] | Displays help messages about the interactive commands.  |
| NEXT               | Moves the structure pointer to the next structure on the current level. The structure is displayed.<br><br>Pressing the Return key is equivalent to a NEXT command.   |
| REST               | Moves the structure pointer along the rest of the structures on the current level, and each is displayed in turn.   |
| TOP                | Moves the structure pointer up to the file header. The file header is displayed.  |
| UP                 | Moves the structure pointer up to the next level. The structure at that level is displayed.   |

# Maintaining Files

## 10.1 Viewing File Characteristics

### 10.1.4 Examining a Sequential File

Figure 10–1 shows the tree structure of a sequential file.

**Figure 10–1 Tree Structure for Sequential Files**

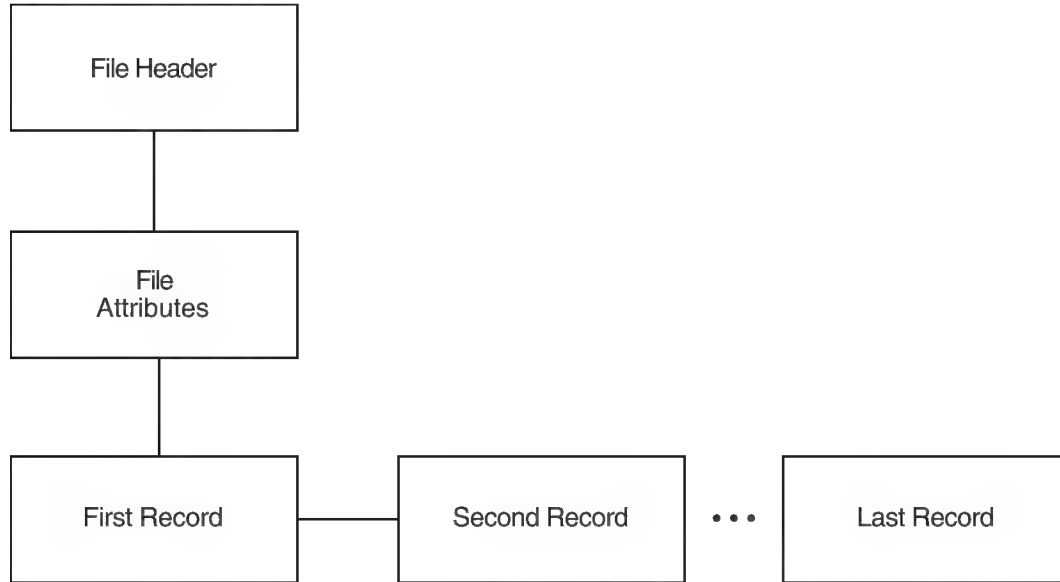

ZK-0327-GE

The FILE HEADER structure is always the first structure displayed. From the FILE HEADER structure, the DOWN command moves the current position to the FILE ATTRIBUTES structure. The DOWN command from the FILE ATTRIBUTES structure moves the current position to the first record in the file. From the first record, the REST command will move the current position through the records in the file, displaying each one in turn. A series of NEXT commands will also accomplish this same operation.

Figure 10–2 shows the layout and contents of the records in a sequential file SEQ.DAT. Example 10–3 is an interactive examination of SEQ.DAT, showing the contents of three records in the file.

**Figure 10–2 Record Layout and Content for SEQ.DAT**

|   |   |   |   |   |   |   |   |   |   |    |    |    |    |    |    |    |    |    |    |    |    |    |    |    |    |    |    |    |    |    |    |    |    |    |    |    |    |    |    |    |    |    |   |   |  |
|---|---|---|---|---|---|---|---|---|---|----|----|----|----|----|----|----|----|----|----|----|----|----|----|----|----|----|----|----|----|----|----|----|----|----|----|----|----|----|----|----|----|----|---|---|--|
| 0 | 1 | 2 | 3 | 4 | 5 | 6 | 7 | 8 | 9 | 10 | 11 | 12 | 13 | 14 | 15 | 16 | 17 | 18 | 19 | 20 | 21 | 22 | 23 | 24 | 25 | 26 | 27 | 28 | 29 | 30 | 31 | 32 | 33 | 34 | 35 | 36 | 37 | 38 | 39 | 40 | 41 | 42 |   |   |  |
| C | U | S | T |   |   |   |   |   | N | A  | M  | E  |    |    |    |    |    |    | S  | T  | R  | E  | E  | T  |    |    |    |    | C  | I  | T  | Y  |    |    |    | S  | T  | A  | T  | E  |    | Z  | I | P |  |
| 0 | 0 | 0 | 1 | A | B | C |   |   | C | O  | M  | P  | U  | T  | E  | R  | S  |    | 1  | 7  | 5  |    | A  | S  | H  |    |    |    | C  | H  | I  | C  | A  | G  | O  |    | I  | L  | 4  | 3  | 4  | 1  | 7 |   |  |
| 0 | 0 | 0 | 2 | D | A | V | I | S |   | M  | O  | V  | E  | R  | S  |    |    |    | 3  | 3  | 3  |    | M  | A  | P  | L  | E  |    | D  | A  | L  | L  | A  | S  |    | T  | X  | 5  | 0  | 1  | 0  | 1  |   |   |  |
| 0 | 0 | 0 | 3 | A | L | L | R | E | X |    | D  | R  | U  | G  |    |    |    |    | 3  | 2  | 7  |    | P  | A  | R  | K  |    | M  | I  | A  | M  | I  |    |    | F  | L  | 3  | 2  | 5  | 7  | 4  |    |   |   |  |

ZK-0737-GE

## Maintaining Files

### 10.1 Viewing File Characteristics

#### Example 10-3 Examining a Sequential File

```
$ ANALYZE/RMS_FILE/INTERACTIVE SEQ.DAT
```

```
FILE HEADER
```

```
File Spec: DISK$DELPHIWORK:[RMS32]SEQ.DAT;3
File ID: (1170,2,2)
Owner UIC: [730,465]
Protection: System: RWED, Owner: RWED, Group: RWED, World:
Creation Date: 7-MAY-1993 16:51:30.92
Revision Date: 8-MAY-1993 14:02:17.15, Number: 3
Expiration Date: none specified
Backup Date: none posted
Contiguity Options: none
Performance Options: none
Reliability Options: none
```

```
ANALYZE> DOWN
```

```
RMS FILE ATTRIBUTES
```

```
File Organization: sequential
Record Format: variable
Record Attributes: carriage-return
Maximum Record Size: 0
Longest Record: 73
Blocks Allocated: 3, Default Extend Size: 0
End-of-File VBN: 1, Offset: %X'00E4'
File Monitoring: disabled
Global Buffer Count: 0
```

```
ANALYZE> DOWN
```

```
DATA BYTES (VBN 1, offset %X'0000'):
  7 6 5 4 3 2 1 0          01234567
-----
31 30 30 30 30 30 00 49 | 0000 | I.000001
20 4C 41 54 49 47 49 44 | 0008 | COMPAQ
4E 45 4D 50 49 55 51 45 | 0010 | COMPUTER
52 4F 50 52 4F 43 20 54 | 0018 | CORPORAT
31 31 20 4E 4F 49 54 41 | 0020 | ION 110
42 20 54 49 50 53 20 30 | 0028 | SPIT BRO
41 4F 52 20 4B 4F 4F 52 | 0030 | OK ROAD
41 55 48 53 41 4E 20 44 | 0038 | NASHUA
33 30 48 4E 20 20 20 20 | 0040 | NH030
                          | 0048 | 62. |
```

```
ANALYZE> NEXT
```

```
DATA BYTES (VBN 1, offset %X'004C'):
  7 6 5 4 3 2 1 0          01234567
-----
32 30 30 30 30 30 00 49 | 0000 | I.000002
49 46 46 4F 20 42 44 41 | 0008 | ADB OFFI
4C 50 50 55 53 20 45 43 | 0010 | CE SUPPL
20 20 20 20 20 53 45 49 | 0018 | IES
32 34 20 20 20 20 20 20 | 0020 | 42
4F 4D 45 53 4F 52 20 30 | 0028 | 0 ROSEMO
45 52 54 53 20 54 4E 55 | 0030 | UNT STRE
49 44 20 4E 41 53 54 45 | 0038 | ETSAN DI
32 39 41 43 20 4F 47 45 | 0040 | EGO CA92
                          | 0048 | 110. |
```

(continued on next page)

# Maintaining Files

## 10.1 Viewing File Characteristics

### Example 10-3 (Cont.) Examining a Sequential File

ANALYZE> NEXT

```
DATA BYTES (VBN 1, offset %X'0098'):  
  7  6  5  4  3  2  1  0          01234567  
-----  
33 30 30 30 30 30 00 49 | 0000 | I.000003 |  
52 50 20 52 4F 4C 4F 43 | 0008 | COLOR PR |  
4C 20 47 4E 49 54 4E 49 | 0010 | INTING L |  
52 4F 54 41 52 4F 42 41 | 0018 | ABORATOR |  
34 39 20 20 20 53 45 49 | 0020 | IES  94 |  
35 20 54 53 41 45 20 39 | 0028 | 9 EAST 5 |  
45 45 52 54 53 20 48 54 | 0030 | TH STREE |  
4F 59 20 57 45 4E 20 54 | 0038 | T NEW YO |  
30 31 59 4E 20 20 4B 52 | 0040 | RK NY10 |  
                        00 33 30 30 | 0048 | 003. |
```

ANALYZE> EXIT



# Maintaining Files

## 10.1 Viewing File Characteristics

### Example 10-4 Examining a Relative File

```
FILE HEADER
  File Spec: DISK$NEWWORK:[RMS32]REL.DAT;1
  File ID: (9573,7,2)
  Owner UIC: [181,065]
  Protection: System: RWED, Owner: RWED, Group: RE, World:
  Creation Date: 22-MAY-1993 10:42:04.95
  Revision Date: 22-MAY-1993 10:42:05.81, Number: 1
  Expiration Date: none specified
  Backup Date: none posted
  Contiguity Options: contiguous-best-try
  Performance Options: none
  Reliability Options: none
```

ANALYZE> DOWN

```
RMS FILE ATTRIBUTES
  File Organization: relative
  Record Format: variable
  Record Attributes: carriage-return
  Maximum Record Size: 75
  Blocks Allocated: 9, Default Extend Size: 0
  Bucket Size: 3
  File Monitoring: disabled
  Global Buffer Count: 0
```

ANALYZE> DOWN

```
FIXED PROLOG
  Prolog Flags:
    (0) PLG$V_NOEXTEND 0
  First Data Bucket VBN: 2
  Maximum Record Number: 2147483647
  End-of-File VBN: 10
  Prolog Version: 1
```

ANALYZE> DOWN

DATA BUCKET (VBN 2)

ANALYZE> DOWN

```
RECORD CELL (VBN 2, offset %X'0000'):
  Cell Control Flags:
    (2) DLC$V_DELETED 0
    (3) DCL$V_REC 1
  Record Bytes:
    7 6 5 4 3 2 1 0 01234567
    -----
    31 30 30 30 30 30 00 49 | 0000 | I.000001
    20 4C 41 54 49 47 49 44 | 0008 | COMPAQL
    4E 45 4D 50 49 55 51 45 | 0010 | COMPUTER
    52 4F 50 52 4F 43 20 54 | 0018 | CORPORAT
    31 31 20 4E 4F 49 54 41 | 0020 | ION 110
    42 20 54 49 50 53 20 30 | 0028 | SPIT BRO
    41 4F 52 20 4B 4F 4F 52 | 0030 | OK ROAD
    41 55 48 53 41 4E 20 44 | 0038 | NASHUA
    33 30 48 4E 20 20 20 20 | 0040 | NH030
    31 36 30 | 0048 | 62
```

If you use the REST command at the CELL AND RECORD level, the utility will display all the cells and records in the file, not just the cells and records in the current bucket.

### 10.1.6 Examining an Indexed File

The structure of an indexed file also begins with the FILE HEADER, FILE ATTRIBUTES, and PROLOG structures. From the PROLOG structure, the file structure branches to the area descriptors and the key descriptors. To branch to the area descriptor path, specify the command DOWN AREA. To branch to the key descriptor path, specify DOWN KEY.

The area descriptor path contains structures that show information about the various areas in the file. The key descriptor path contains the primary key structures (and data records) and any secondary key structures.

Figure 10–4 shows the structure following the area descriptor path.

Figure 10–4 Area Descriptor Path

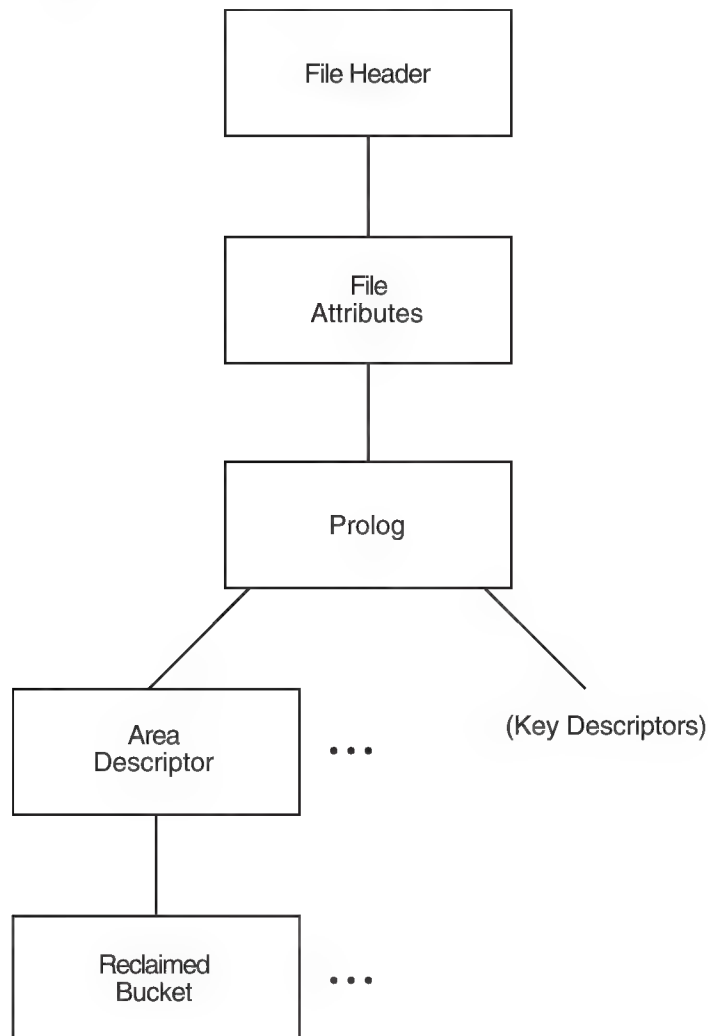

ZK-0329-GE

## Maintaining Files

### 10.1 Viewing File Characteristics

Example 10–5 shows an examination of an area descriptor path from the PROLOG level.

#### Example 10–5 Examining an Area Descriptor Path

```
ANALYZE> DOWN AREA
```

```
AREA DESCRIPTOR #0 (VBN 3, offset %X'0000')
  Bucket Size: 1)
  Alignment: AREA$C NONE)
  Alignment Flags: )
    (0) AREA$V_HARD      0)
    (1) AREA$V_ONC      0)
    (5) AREA$V_CBT      0)
    (7) AREA$V_CTB      0)
  Current Extent Start: 1, Blocks: 9, Used: 7, Next: 8)
  Default Extend Quantity: 0)
```

Figure 10–5 shows the structure following the key descriptor path. As shown in the figure, you can branch directly to the DATA BUCKET, or you can branch to the INDEX ROOT BUCKET to begin examination of the index structure, eventually reaching the DATA BUCKET structure. Depending on whether you are examining the primary index structure or one of the alternate index structures, there is a difference in the contents of the record structure.

The PRIMARY RECORD structure contains the actual data records; the ALTERNATE RECORD structures contain secondary index data records (SIDRs).

Figure 10-5 Key Descriptor Path

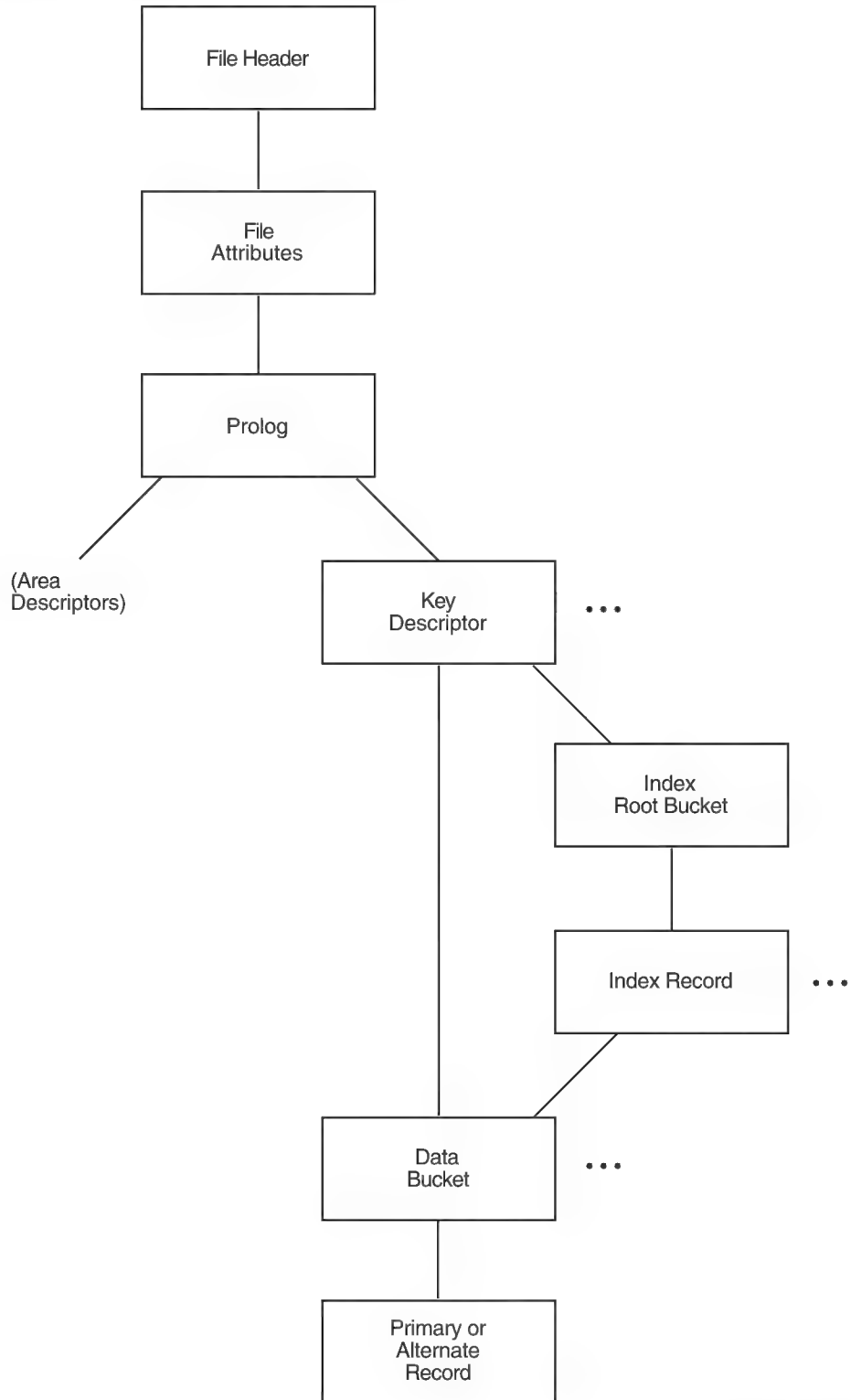

ZK-0330-GE

# Maintaining Files

## 10.1 Viewing File Characteristics

Figure 10–6 displays the structure of the primary records.

**Figure 10–6 Structure of Primary Records**

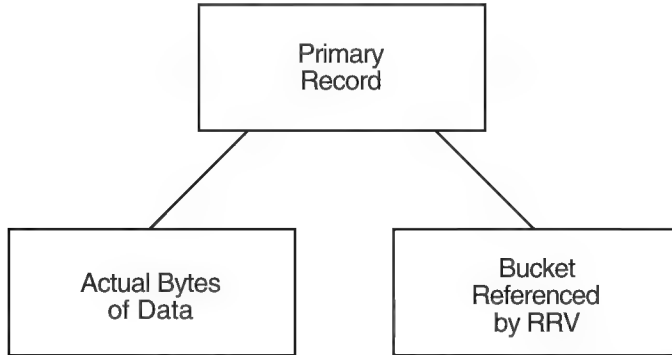

ZK-0332-GE

As shown in Figure 10–6, the branch from the primary record structure allows you to either examine the actual bytes of data within the record or to follow the RRV.

Example 10–6 shows an examination of a primary record.

**Example 10–6 Examining a Primary Record**

```

PRIMARY DATA RECORD (VBN 4, offset %X'000E')
Record Control Flags:
  (2) IRC$V_DELETED    0
  (3) IRC$V_RRV       0
  (4) IRC$V_NOPTRSZ   0
Record ID: 1
RRV ID: 1, 4-Byte Bucket Pointer: 4
Key:
      7 6 5 4 3 2 1 0          01234567
-----
      31 30 30 30 30 30 30 | 0000 | 000001 |
  
```

ANALYZE> DOWN BYTES

```

      7 6 5 4 3 2 1 0          01234567
-----
31 30 30 30 30 30 00 49 | 0000 | I.000001 |
20 4C 41 54 49 47 49 44 | 0008 | COMPAQ  |
4E 45 4D 50 49 55 51 45 | 0010 | COMPUTER|
52 4F 50 52 4F 43 20 54 | 0018 | CORPORAT|
31 31 20 4E 4F 49 54 41 | 0020 | ION 110  |
42 20 54 49 50 53 20 30 | 0028 | SPIT BRO |
41 4F 52 20 4B 4F 4F 52 | 0030 | OK ROAD  |
41 55 48 53 41 4E 20 44 | 0038 | NASHUA   |
33 30 48 4E 20 20 20 20 | 0040 |          |
                        31 36 30 | 0048 | 062     |
  
```

ANALYZE> UP

(continued on next page)

**Example 10-6 (Cont.) Examining a Primary Record**

```

PRIMARY DATA RECORD (VBN 4, offset %X'000E')
Record Control Flags:
    (2) IRC$V_DELETED      0
    (3) IRC$V_RRV         0
    (4) IRC$V_NOPTRSZ     0
Record ID: 1
RRV ID: 1, 4-Byte Bucket Pointer: 4
Key:
      7 6 5 4 3 2 1 0          01234567
-----
      31 30 30 30 30 30 | 0000 |000001 |
  
```

ANALYZE> DOWN RRV

```

BUCKET HEADER (VBN 4)
Check Character: %X'00'
Area Number: 0
VBN Sample: 4
Free Space Offset: %X'0104'
Free Record ID Range: 4 - 255
Next Bucket VBN: 4
Level: 0
Bucket Header Flags:
    (0) BKT$V_LASTBKT     1
    (1) BKT$V_ROOTBKT    0
  
```

Figure 10-7 displays the structure of the alternate records.

**Figure 10-7 Structure of Alternate Records**

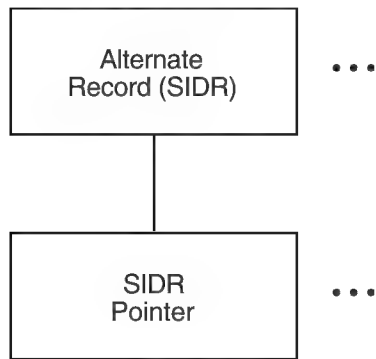

ZK-0333-GE

## Maintaining Files

### 10.1 Viewing File Characteristics

Example 10–7 shows an examination of an alternate record.

#### Example 10–7 Examining an Alternate Record

```
ANALYZE> DOWN

SIDR RECORD (VBN 6, offset %X'000E')
  Control Flags:
    (4) IRC$V_NOPTRSZ    0
  Record ID: 1
  Key:
      7 6 5 4 3 2 1 0          01234567
      -----
      31 36 30 33 30| 0000 |03062 |

ANALYZE> DOWN

sidr pointer control flags:
  (2) IRC$V_DELETED    0
  (5) IRC$V_KEYDELETE  0
sidr pointer record id: 1, 4-byte record VBN: 4
```

## 10.2 Generating an FDL File from a Data File

You can use the Analyze/RMS\_File utility to create an FDL file generally called an *analysis file*. FDL files created by ANALYZE/RMS\_FILE contain statistics about each area and key in the primary sections named ANALYSIS\_OF\_AREA and ANALYSIS\_OF\_KEY.

These analysis sections are then used by the Edit/FDL utility in its Optimize script. You can compare the statistics in these sections with your assumptions about the file's use; you may find some places in the file's structure where additional tuning will be possible.

To generate an FDL file from a data file, use the following command syntax:

```
ANALYZE/RMS_FILE/FDL filespec
```

With a command of this type, the FDL file obtains its file name from the input file specification; to assign a different file name, use the /OUTPUT qualifier. For example, the following command would generate an FDL file named INDEXDEF.FDL from the data file CUSTFILE.DAT:

```
$ ANALYZE/RMS_FILE/FDL/OUTPUT=INDEXDEF CUSTFILE.DAT
```

Example 10–8 shows an FDL file showing the KEY and ANALYSIS\_OF\_KEY sections for an indexed file with two keys.

## Maintaining Files

### 10.2 Generating an FDL File from a Data File

#### Example 10-8 KEY and ANALYSIS\_OF\_KEY Sections in an FDL File

```

IDENT          2-JUN-1993 16:15:35          VMS ANALYZE/RMS_FILE Utility
SYSTEM
FILE           SOURCE                        VMS
ALLOCATION      9
BEST_TRY_CONTIGUOUS  no
BUCKET_SIZE    1
CONTIGUOUS     no
EXTENSION      0
GLOBAL_BUFFER_COUNT  0
NAME           DISK$USERWORK:[WORK.RMS32]CUSTDATA.DAT;4
ORGANIZATION   indexed
OWNER          [520,50]
PROTECTION     (system:RWED, owner:RWED, group:RWED, world:)
READ_CHECK     no
WRITE_CHECK    no

RECORD
BLOCK_SPAN     yes
CARRIAGE_CONTROL carriage_return
FORMAT         variable
SIZE           0

AREA 0
BEST_TRY_CONTIGUOUS  no
BUCKET_SIZE    1
CONTIGUOUS     no
EXTENSION      0

KEY 0
CHANGES       no
DATA_AREA      0
DATA_FILL      100
DUPLICATES     no
INDEX_AREA     0
INDEX_FILL     100
LEVEL1_INDEX_AREA  0
NULL_KEY       no
PROLOG         1
SEGO_LENGTH    6
SEGO_POSITION  0
TYPE           string

KEY 1
CHANGES       no
DATA_AREA      0
DATA_FILL      100
DUPLICATES     yes
INDEX_AREA     0
INDEX_FILL     100
LEVEL1_INDEX_AREA  0
NULL_KEY       no
SEGO_LENGTH    5
SEGO_POSITION  68
TYPE           string

ANALYSIS_OF_AREA 0
RECLAIMED_SPACE  0

```

(continued on next page)

## Maintaining Files

### 10.2 Generating an FDL File from a Data File

#### Example 10–8 (Cont.) KEY and ANALYSIS\_OF\_KEY Sections in an FDL File

```
ANALYSIS_OF_KEY 0
  DATA_FILL                50
  DATA_RECORD_COUNT        3
  DATA_SPACE_OCCUPIED      1
  DEPTH                      1
  INDEX_FILL                4
  INDEX_SPACE_OCCUPIED      1
  MEAN_DATA_LENGTH          73
  MEAN_INDEX_LENGTH         9

ANALYSIS_OF_KEY 1
  DATA_FILL                14
  DATA_RECORD_COUNT        3
  DATA_SPACE_OCCUPIED      1
  DEPTH                      1
  DUPLICATES_PER_SIDR       1
  INDEX_FILL                4
  INDEX_SPACE_OCCUPIED      1
  MEAN_DATA_LENGTH          19
  MEAN_INDEX_LENGTH         8
```

### 10.3 Optimizing and Redesigning File Characteristics

To maintain your files properly, you must occasionally tune them. Tuning involves adjusting and readjusting the characteristics of the file, generally to make the file run faster or more efficiently, and then reorganizing the file to reflect those changes.

There are two ways to tune files. You can redesign your FDL file to change file characteristics or parameters. You can change these characteristics either interactively with the Edit/FDL utility (the preferred method) or by using a text editor. With the redesigned FDL file, then, you can create a new data file.

You can also optimize your data file by using ANALYZE/RMS\_FILE with the /FDL qualifier. This method, rather than actually redesigning your FDL file, produces an FDL file containing certain statistics about the file's use that you can then use to tune your existing data file.

Figure 10–8 shows how to use the RMS utilities to perform the tuning cycle.

Figure 10–8 RMS Tuning Cycle

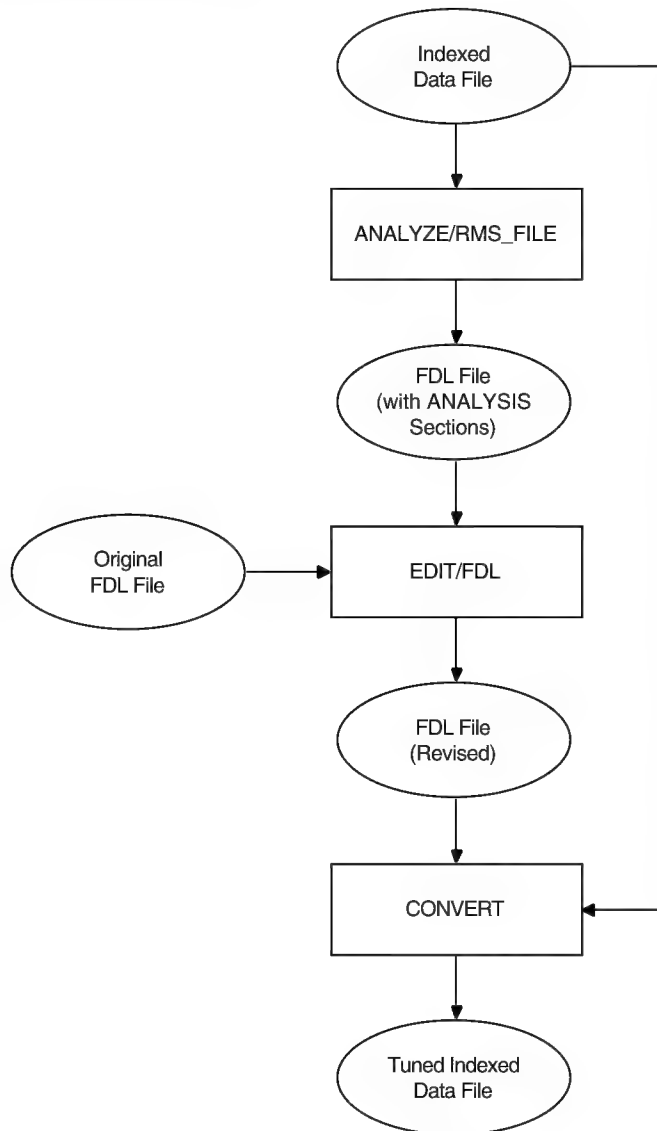

ZK-0952-GE

Section 10.3.1 describes how to redesign an FDL file, and Section 10.3.2 explains how to optimize the run-time performance of a data file.

### 10.3.1 Redesigning an FDL File

There are many ways to redesign an FDL file. If you want to make small changes, you can use the ADD, DELETE, and MODIFY commands at the main menu (main editor) level.

## Maintaining Files

### 10.3 Optimizing and Redesigning File Characteristics

| Command | Function   |
|---------|--|
| ADD     | <p>Allows you to add one or more new lines to the FDL file. When you give the ADD command at the main menu level, the Edit/FDL utility prompts you with a menu displaying all legal primary attributes; your FDL file does not necessarily have to contain all these attributes. You can add a new primary attribute to your file, or you can add a new secondary attribute to an existing primary attribute.</p> <p>When you type in a primary attribute, the Edit/FDL utility displays all the legal secondary attributes for that primary attribute with their possible values. You can then select the secondary attribute that you want to add to your FDL file and supply the appropriate value for the secondary attribute.</p> |
| DELETE  | <p>Allows you to delete one or more lines from the FDL file. When you give the DELETE command at the main menu level, the Edit/FDL utility prompts you with a menu displaying the current primary attributes of your FDL file.</p> <p>When you select the primary attribute for the attribute you want to remove from your FDL definition, the Edit/FDL utility displays the current values for all of the FDL file's secondary attributes. When you select the appropriate secondary from this list, the Edit/FDL utility removes it from the FDL definition. If you delete all of the secondary attributes of a primary attribute, the Edit/FDL utility removes the primary attribute from the current definition.</p>               |
| MODIFY  | <p>Allows you to change an existing line in the FDL definition. When you issue the MODIFY command at the main menu level, the Edit/FDL utility prompts you with a menu displaying the current primary attributes of your FDL file.</p> <p>When you type in a primary attribute, the Edit/FDL utility displays all the existing secondary attributes for that primary attribute with their current values. You can then select the secondary attribute of which you want to change the value and then supply the appropriate value for the secondary attribute.</p>   |

However, if you want to make substantial changes to an FDL file, you should invoke the Touch-up script. Because sequential and relative files are simple in design, the Touch-up script works only with FDL files that describe indexed files. If you want to redesign sequential and relative files, you can use the command listed above (ADD, DELETE, or MODIFY), or you can go through the design phase again, using the scripts for those organizations.

To completely redesign an existing FDL file that describes an indexed sequential file, use the following command syntax:

```
EDIT/FDL/SCRIPT=TOUCHUP fdl-filespec
```

#### 10.3.2 Optimizing a Data File

To improve the performance of a data file, use a 3-step procedure that includes analysis, FDL optimization, and conversion of the file. If used periodically during the life of a data file, this procedure yields a file that performs optimally.

For the analysis, use the ANALYZE/RMS\_FILE/FDL command to create an output file (**analysis-fdl-file**) that reflects the current state of the data file. The command syntax for creating the **analysis-fdl-file** follows:

```
ANALYZE/RMS_FILE/FDL/OUTPUT=analysis-fdl-file original-data-file
```

The output file **analysis-fdl-file** contains all of the information and statistics about the data file, including create-time attributes and information that reflects changes made to the structure and contents of the data file over its life.

## 10.3 Optimizing and Redesigning File Characteristics

For FDL optimization, use the Edit/FDL utility to produce an optimized output file (**optimized-fdl-file**). You can do this by modifying either the original FDL file (**original-fdl-file**) if available, or the FDL output of the file analysis **analysis-fdl-file**.

Modification of an FDL file can be performed either interactively using a terminal dialogue or noninteractively by allowing the Edit/FDL utility to calculate optimal values based on analysis information.

To optimize the file interactively using an OPTIMIZE script, use a command with the following format:

```
EDIT/FDL/ANALYSIS=analysis-fdl-file/SCRIPT=OPTIMIZE-
/OUTPUT=optimized-fdl-file original-fdl-file
```

To optimize the file noninteractively, use a command with the following format:

```
EDIT/FDL/ANALYSIS=analysis-fdl-file/NOINTERACTIVE-
/OUTPUT=optimized-fdl-file original-fdl-file
```

The **optimized-fdl-file** parameter is the optimized version of the original FDL file.

Conversion is the process of applying the optimized FDL file to the original data file. You use the Convert utility to do this using a command with the following syntax:

```
CONVERT/FDL=optimized-fdl-file original-data-file new-data-file
```

## 10.4 Making a File Contiguous

If your file has been used for some time or if it is extremely volatile, the numerous deletions and insertions of records may have caused the optimal design of the file to deteriorate. For example, numerous extensions will degrade performance by causing window-turn operations. In indexed files, deletions can cause empty but unusable buckets to accumulate.

If additions or insertions to a file cause too many extensions, the file's performance will also deteriorate. To improve performance, you could increase the file's window size, but this uses an expensive system resource and at some point may itself hurt performance. A better method is to make the file contiguous again.

This section presents techniques for cleaning up your files. These techniques include using the Copy utility, the Convert utility, and the Convert/Reclaim utility.

### 10.4.1 Using the Copy Utility

You can use the COPY command with the /CONTIGUOUS qualifier to copy the file, creating a new contiguous version. The /CONTIGUOUS qualifier can be used only on an output file.

To use the COPY command with the /CONTIGUOUS qualifier, use the following command syntax:

```
COPY input-filespec output-filespec/CONTIGUOUS
```

If you do not want to rename the file, use the same name for **input-filespec** and **output-filespec**.

## Maintaining Files

### 10.4 Making a File Contiguous

By default, if the input file is contiguous, COPY likewise tries to create a contiguous output file. By using the /CONTIGUOUS qualifier, you ensure that the output file is copied to consecutive physical disk blocks.

The /CONTIGUOUS qualifier can only be used when you copy disk files; it does not apply to tape files. For more information, see the COPY command in the *OpenVMS DCL Dictionary*.

#### 10.4.2 Using the Convert Utility

The Convert utility can also make a file contiguous if contiguity is an original attribute of the file.

To use the Convert utility to make a file contiguous, use the following command syntax:

```
CONVERT input-filespec output-filespec
```

If you do not want to rename the file, use the same name for **input-filespec** and **output-filespec**.

#### 10.4.3 Reclaiming Buckets in Prolog 3 Files

If you delete a number of records from a Prolog 3 indexed file, it is possible that you deleted all of the data entries in a particular bucket. RMS generally cannot use such empty buckets to write new records.

With Prolog 3 indexed files, you can reclaim such buckets by using the Convert/Reclaim utility. This utility allows you to reclaim the buckets without incurring the overhead of reorganizing the file with CONVERT.

As the data buckets are reclaimed, the pointers to them in the index buckets are deleted. If as a result any of the index buckets become empty, they too are reclaimed.

Note that RFA access is retained after bucket reclamation. The only effect that CONVERT/RECLAIM has on a Prolog 3 indexed file is that empty buckets are reclaimed.

To use CONVERT/RECLAIM, use the following command syntax, in which **filespec** specifies a Prolog 3 indexed file:

```
CONVERT/RECLAIM filespec
```

Please note that the file cannot be open for shared access at the time that you give the CONVERT/RECLAIM command.

### 10.5 Reorganizing a File

Using the Convert utility is the easiest way to reorganize a file. In addition, CONVERT cleans up split buckets in indexed files. Also, because the file is completely reorganized, buckets in which all the records were deleted will disappear. (Note that this is not the same as bucket reclamation. With CONVERT, the file becomes a new file and records receive new RFAs.)

To use the Convert utility to reorganize a file, use the following command syntax:

```
CONVERT input-filespec output-filespec
```

If you do not want to rename the file, use the same name for **input-filespec** and **output-filespec**.

## 10.6 Making Archive Copies

Another part of maintaining files is making sure that you protect the data in them. You should keep duplicates of your files in another place in case something happens to the originals. In other words, you need to **back up** your files. Then, if something does happen to your original data, you can restore the duplicate files.

The Backup utility (BACKUP) allows you to create backup copies of files and directories, and to restore them as well. These backup copies are called **save sets**, and they can reside on either disk or magnetic tape. Save sets are also written in BACKUP format; only BACKUP can interpret the data.

Unlike the DCL command COPY, which makes new copies of files (updating the revision dates and assigning protection from the defaults that apply), BACKUP makes copies that are identical in all respects to the originals, including dates and protection.

To use the Backup utility to create a save set of your file, use the following command syntax:

```
BACKUP input-filespec output-filespec[/SAVE_SET]
```

You have to use the /SAVE\_SET qualifier only if the output file will be backed up to disk. You can omit the qualifier for magnetic tape.

For more information about BACKUP, see the description of the Backup utility in the *OpenVMS System Management Utilities Reference Manual*.



---

## Edit/FDL Utility Optimization Algorithms

This appendix lists the algorithms used by the Edit/FDL utility to determine the optimum values for file attributes.

### A.1 Allocation

For sequential files with block spanning, the Edit/FDL utility allocates enough blocks to hold the specified number of records of mean size. If you do not allow block spanning, the Edit/FDL utility factors in the potential wasted space at the end of each block.

For relative files, the Edit/FDL utility calculates the total number of buckets in the file and then allocates enough blocks to hold the required number of buckets and associated overhead. The Edit/FDL utility calculates the total number of buckets by dividing the total number of records in the file by the bucket record capacity. The overhead consists of the prolog which is equal to one block and is stored in VBN 1.

For indexed files, the Edit/FDL utility calculates the depth to determine the actual bucket size and number of buckets at each level of the index. It then allocates enough blocks to hold the required number of buckets. Areas for the data level (Level 0) have separate allocations from the areas for the index levels of each key.

In all cases, allocations are rounded up to a multiple of bucket size.

### A.2 Extension Size

For sequential files, the Edit/FDL utility sets the extension size to one-tenth of the allocation size and truncates any fraction. For relative files and indexed files, the Edit/FDL utility extends the file by 25 percent rounded up to the next multiple of the bucket size.

### A.3 Bucket Size

Because most records that the Edit/FDL utility accesses are close to each other, it makes the buckets large enough to hold 16 records or the total record capacity of the file, whichever is smaller. The maximum bucket size is 63 blocks.

For indexed files, the Edit/FDL utility permits you to decide the bucket size for any particular index. The data and index levels get the same bucket size but you can use the MODIFY command to change these values.

The Edit/FDL utility calculates the default bucket size by first finding the most common index depth produced by the various bucket sizes. If you specify smaller buffers rather than fewer levels, the Edit/FDL utility establishes the default bucket size as the smallest size needed to produce the most common depth. On Surface\_Plot graphs, these values are shown on the leftmost edge of each bucket size.

## Edit/FDL Utility Optimization Algorithms

### A.3 Bucket Size

---

#### Note

---

If you specify a separate bucket size for the Level 1 index, it should match the bucket size assigned to the rest of the index.

---

The bucket size is always a multiple of disk cluster size. The ANALYZE/RMS\_FILE primary attribute ANALYSIS\_OF\_KEY now has a new secondary attribute called LEVEL1\_RECORD\_COUNT that represents the index level immediately above the data. It makes the tuning algorithm more accurate when duplicate key values are specified.

### A.4 Global Buffers

The global buffer count is the number of I/O buffers that two or more processes can access. This algorithm tries to cache or “map” the whole Key 0 index (at least up to a point) into memory for quicker and more efficient access.

### A.5 Index Depth

The indexed design routines simulate the loading of data buckets with records based on your data regarding key sizes, key positions, record sizes (mean and maximum), compression values, load method, and fill factors.

When the Edit/FDL utility finds the number of required data buckets, it can determine the actual number of index records in the next level up (each of which points to a data bucket). The process is repeated until all the required index records for a level can fit in one bucket, the root bucket. When a file exceeds 32 levels, the Edit/FDL utility issues an error message.

With a line\_plot, the design calculations are performed up to 63 times—once for each legal bucket size. With a surface\_plot, each line of the plot is equivalent to a line\_plot with a different value for the variable on the Y-axis.

---

# Glossary

This glossary defines terms used in this manual.

**accessor**

A process that accesses a file or a record stream that accesses a record.

**alternate key**

An optional key within the data records in an indexed file; used by RMS to build an alternate index. See also *key (indexed file)* and *primary key*.

**area**

An RMS-maintained region of an indexed file. It allows you to specify placement or specific bucket sizes, or both, for particular portions of a file. An area consists of any number of buckets, and there may be from 1 to 255 areas in a file.

**asynchronous record operation**

An operation in which your program may possibly regain control before the completion of a record retrieval or storage request. Completion ASTs and the Wait service are the mechanisms provided by RMS for programs to synchronize with asynchronous record operations. See also *synchronous record operation*.

**bits per inch**

The recording density of a magnetic tape. Indicates how many characters can fit on one inch of the recording surface. See also *density*.

**block**

The smallest number of consecutive bytes that RMS transfers during read and write operations. A block is 512 8-bit bytes on a Files-11 On-Disk Structure disk; on magnetic tape, a block may be anywhere from 8 to 8192 bytes.

**block I/O**

The set of RMS procedures that allows you direct access to the blocks of a file regardless of file organization.

**block spanning**

In a sequential file, the option for records to cross block boundaries.

**bootstrap block**

A block in the index file of a system disk. Can contain a program that loads the operating system into memory.

**bucket**

A storage structure, consisting of 1 to 32 blocks, used for building and processing relative and indexed files. A bucket contains one or more records or record cells. Buckets are the units of contiguous transfer between RMS buffers and the disk.

**bucket split**

The result of inserting records into a full bucket. To minimize bucket splits, RMS attempts to keep half of the records in the original bucket and transfer the remaining records to a newly created bucket.

**buffer**

A memory area used to temporarily store data. Buffers are generally categorized as being either user buffers or I/O buffers.

**cluster**

The basic unit of space allocation on a Files-11 On-Disk Structure volume. Consists of one or more contiguous blocks, with the number being specified when the volume is initialized.

**contiguous area**

A group of physically adjacent blocks.

**count field**

A 2-byte field prefixed to a variable-length record that specifies the number of data bytes in the record. This field may be formatted in either LSB or MSB format.

**cylinder**

The tracks at the same radius on all recording surfaces of a disk.

**density**

The number of bits per inch (bpi) of magnetic tape. Typical values are 800 bpi and 1600 bpi. See also bits per inch.

**directory**

A file used to locate files on a volume. A directory file contains a list of files and their unique internal identifications.

**directory tree**

The subdirectories created beneath a directory and the subdirectories within the subdirectories (and so forth).

**disk**

See volume (disk).

**extent**

One or more adjacent clusters allocated to a file or to a portion of a file.

**FDL**

See File Definition Language.

**file**

An organized collection of related items (records) maintained in an accessible storage area, such as disk or tape.

**File Definition Language (FDL)**

A special-purpose language used to write file creation and run-time specifications for data files. These specifications are written in text files called FDL files; they are then used by the RMS utilities and library routines to create the actual data files.

**file header**

A block in the index file describing a file on a Files-11 On-Disk Structure disk, including the location of the file's extents. There is at least one file header for every file on the disk.

**file organization**

The physical arrangement of data in the file. You select the specific organization from those offered by RMS, based on your individual needs for efficient data storage and retrieval. See also indexed file organization, relative file organization, and sequential file organization.

**Files-11 On-Disk Structure**

The standard physical disk structure used by RMS.

**fixed-length control field**

A fixed-size area, prefixed to a VFC record, containing additional information that can be processed separately and that may have no direct relationship to the other contents of the record. For example, the fixed-length control field might contain line sequence numbers for use in editing operations.

**fixed-length record format**

Property of a file in which all records are the same length. This format provides simplicity in determining the exact location of a record in the file and eliminates the need to prefix a record size field to each record.

**global buffer**

A buffer that many processes share.

**home block**

A block in the index file, normally next to the bootstrap block, that identifies the volume as a Files-11 On-Disk Structure volume and provides specific information about the volume, such as volume label and protection.

**index**

The structure that allows retrieval of records in an indexed file by key value. See also key (indexed file).

**index file**

A file on each Files-11 On-Disk Structure volume that provides the means for identification and initial access to the volume. Contains the access information for all files (including itself) on the volume: bootstrap block, home block, file headers.

**indexed file organization**

A file organization that allows random retrieval of records by key value and sequential retrieval of records in sorted order by key value. See also key (indexed file).

**interrecord gap (IRG)**

An interval of blank space between data records on the recording surface of a magnetic tape. The IRG enables the tape unit to decelerate, stop if necessary, and accelerate between record operations.

**I/O buffer**

A buffer used for performing input/output operations.

**IRG**

See interrecord gap.

**key (indexed file)**

A character string, a packed decimal number, a 2- or 4-byte unsigned binary number, or a 2- or 4-byte signed integer within each data record in an indexed file. You define the length and location within the records; RMS uses the key to build an index. See also primary key, alternate key, and random access by key value.

**key (relative file)**

The relative record number of each data record cell in a data file; RMS uses the relative record numbers to identify and access data records in a relative file in random access mode. See also relative record number.

**local buffer**

A buffer that is dedicated to one process.

**locate mode**

Technique used for a record input operation in which the data records are not copied from the I/O buffer, but a pointer is returned to the record in the I/O buffer. See also move mode.

**move mode**

Technique used for a record transfer in which the data records are copied between the I/O buffer and your program buffer for calculations or operations on the record. See also locate mode.

**multiblock**

An I/O unit that includes up to 127 blocks. Use is restricted to sequential files.

**multiple-extent file**

A disk file having two or more extents.

**native mode**

The processor's primary execution mode in which the programmed instructions are interpreted as byte-aligned, variable-length instructions that operate on the following data types: byte, word, longword, and quadword integers; floating and double floating character strings; packed decimals; and variable-length bit fields. The other instruction execution mode is compatibility mode.

**OpenVMS RMS**

See RMS (Record Management Services).

**primary key**

The mandatory key within the data records of an indexed file; used to determine the placement of records within the file and to build the primary index. See also key (indexed file) and alternate key.

**random access by key (indexed file)**

Retrieval of a data record in an indexed file by either a primary or alternate key within the data record. See also key (indexed file).

**random access by key (relative file)**

Retrieval of a data record in a relative file by the relative record number of the record. See also key (relative files).

**random access by record file address (RFA)**

Retrieval of a record by the record's unique address, which RMS returns to you. This record access mode is the only means of randomly accessing a sequential file containing variable-length records.

**random access by relative record number**

Retrieval of a record by its relative record number. For relative files and sequential files (on disk devices) that contain fixed-length records, random access by relative record number is synonymous with random access by key. See also random access by key (relative files only) and relative record number.

**read-ahead processing**

A software option used for sequentially accessing sequential files using two buffers. One buffer holds records to be read from the disk. The other buffer awaits I/O completion.

**record**

A set of related data that your program treats as a unit.

**record access mode**

The manner in which RMS retrieves or stores records in a file. Available record access modes are determined by the file organization and specified by your program.

**record access mode switching**

Term applied to the switching from one type of record access mode to another while processing a file.

**record blocking**

The technique of grouping multiple records into a single block. On magnetic tape, an IRG is placed after the block rather than after each record. This technique reduces the number of I/O transfers required to read or write the data, and, in addition (for magnetic tape), it increases the amount of usable storage area. Record blocking also applies to disk files.

**record cell**

A fixed-length area in a relative file that can contain a record. Fixed-length record cells permit RMS to directly calculate the record's actual position in the file.

**record file address (RFA)**

The unique address RMS returns to your program whenever it accesses a record. Using the RFA, your program can access disk records randomly regardless of file organization. The RFA is valid only for the life of the file, and when an indexed file is reorganized, each record's RFA will typically change.

**record format**

The way a record physically appears on the recording surface of the storage medium. The record format defines the method for determining record length.

**record length**

The size of a record in bytes.

**record locking**

A facility that prevents access to a record by more than one record stream or process until the initiating record stream or process releases the record.

**Record Management Services**

See RMS (Record Management Services).

**record stream**

The access environment for reading, writing, deleting and updating records.

**relative file organization**

The arrangement of records in a file in which each record occupies a cell of equal length within a bucket. Each cell is assigned a successive number, called a relative record number, which represents the cell's position relative to the beginning of the file.

**relative record number**

An identification number used to specify the position of a record cell relative to the beginning of the file; used as the key during random access by key mode to relative files.

**reorganization**

A record-by-record copy of an indexed file to another indexed file with the same key attributes as the input file.

**RFA**

See record file address.

**RMS (Record Management Services)**

The file and record access subsystem of the operating system. RMS helps your application program process records within files, thereby allowing interaction between your application program and the data.

**RMS-11**

A set of routines that is linked with compatibility mode and PDP-11 programs and provides similar features for RMS. The file organizations and record formats used by RMS-11 are very similar to those of RMS; one exception is that RMS-11 does not support Prolog 3 indexed files, which are supported by RMS.

**root bucket**

The primary routing bucket for an index; geometrically, the top of the index tree. When a key search begins, RMS goes first to the index root bucket to determine which bucket, at the next lower level, is the next link in the bucket chain.

**seek time**

The time required to position the read/write heads over the selected track.

**sequential file organization**

The arrangement of records in a file in one-after-the-other fashion. Records appear in the order in which they were written.

**sequential record access mode**

Record storage or retrieval that starts at a designated point in the file and continues in one-after-the-other fashion through the file. That is, records are accessed in the order in which they physically appear in the file.

**shared access**

A file management technique that allows more than one user to simultaneously access a file or a group of files.

**stream**

An access window to a file associated with a record access control block (RAB) supporting record operation requests.

**stream record format**

Property of a file specifying that the data in the file is interpreted as a continuous sequence of bytes, without control information, except for terminators that are recognized as record separators. Stream record format applies to sequential files only.

**synchronous record operation**

An operation in which your program does not regain control until after the completion of a record retrieval or storage request. See also asynchronous record operation.

**terminator**

Special characters or character sequences used to delimit the records in files using the stream record format.

**track**

A collection of blocks at a single radius on one recording surface of a disk.

**tuning**

The process of designing your files to achieve better processing performance.

**user buffer**

A buffer within an application program.

**variable-length record format**

Property of a file in which record length may vary.

**variable-length with fixed-length control field (VFC) record format**

Property of a file in which records of variable-length contain an additional fixed-length control field capable of storing data that may have no connection with the other contents of the record. VFC record format is not applicable to indexed files.

**VFC record format**

See variable-length with fixed-length control field (VFC) record format.

**volume (disk)**

An ordered set of 512-byte blocks. The medium that carries Files-11 On-Disk Structure files.

**volume (magnetic tape)**

A reel of magnetic tape, which may contain a part of a file, a complete file, or more than one file.

**volume set**

A collection of related volumes.

**write-behind processing**

A software option used for sequentially accessing sequential files using two buffers. One buffer holds records to be written to the disk. The other buffer awaits I/O completion.

## A

---

### Access

See also Random access; Record access

direct, 1-2

random, 3-16

sequential, 1-2, 3-16

shared, 10-28

in an OpenVMS Cluster, 3-32

to files, 1-31

to process-permanent files, 6-21

ACCESS attributes, 7-3

Access categories, 4-26

Access control lists

See ACLs

Accessibility field, 1-27, 1-31

Accessing files on ODS-5 disks, VAX systems,  
5-14

Access modes

See also Record access mode

ACLs (access control lists)

as protection basis, 4-26

compared with UIC protection, 1-35

ACP truncation

determining factors, 3-9

error, 3-9

using the FAB\$V\_TEF bit, 3-9

Active Streams field, interpretations of zero  
reading, 3-29

ADD command, 10-25

AGAIN command, 10-11

Allocation, 3-24, 4-34, A-1

ALLOCATION attribute, 3-25, 4-35

Allocation-quantity option, 4-35

Alternate indexes, 3-22

Alternate keys, 3-18, 3-19

Alternate record structure, 10-21

Analysis section, 4-4, 10-1, 10-26

ANALYSIS\_OF\_AREA section, 10-1, 10-22

ANALYSIS\_OF\_KEY section, 10-1, 10-22

Analyze/RMS\_File utility (ANALYZE/RMS\_FILE),  
1-37, 10-1, 10-26

commands, 10-11

default file type, 10-5

examining prologs, 3-18

file optimizing, 4-4

with FDL files, 4-2

.ANL file type, 10-5

ANSI magnetic tape

file names, 1-28

standard, 1-19

volumes, 1-19, 1-22

format, 1-20

ANY\_CYLINDER option, 4-35

Application design, 2-1

shared access consideration, 3-3

space consideration, 3-2

speed consideration, 3-1

Area default extension quantity, 3-6

AREA DESCRIPTOR structure, 10-17

Area options, 4-35

Areas, 3-24

defining multiple in an FDL file, 3-25

multiple on a volume set, 3-24

ASCII character set, 1-20

ASSIGN command, /TRANSLATION\_

ATTRIBUTES qualifier, 5-20

Asynchronous operations, 8-18, 8-19

performance, 9-8

Attributes

creation by the Edit/FDL utility, 4-3

primary, 4-9

Auto extends

for Block I/O with sequential files, 3-5

for indexed files, 3-6

how to establish default quantity, 3-6

maximized value, 3-5

minimal size, 3-5

size selection, 3-5

specifying size, 3-5

Auto extend size selections, 3-5

## B

---

Backup log file, 1-10

Backup operations, 1-34

Backup utility (BACKUP), 10-2

eliminating extents, 9-8

making archive copies, 10-29

BADBLK.SYS file, 1-10

Bad block file, 1-10

BADLOG.SYS file, 1-10

Base character set, 5-4  
 BASIC USEROPEN routine, 5-23, 9-5  
 Beginning-of-tape marker  
   See BOT markers  
 BEST\_TRY\_CONTIGUOUS attribute, 3-24, 4-35  
 Binary data, 1-20  
 BITMAP.SYS file, 1-9  
 Bitmaps  
   index file, 1-9  
   storage, 1-9  
 Bits per inch (bits/inch), 1-18  
 Blocked record, 1-31  
 Block I/O, 8-15  
 Block length field, 1-32  
 Blocks, 1-7, 3-10  
 Block size options, 4-32  
 Block span options, 3-13  
   effect on maximum record size, 2-9  
   FDL RECORD section, 4-33  
 BLOCK\_IO attribute, 7-3  
 BLOCK\_SPAN attribute, 3-13, 4-34  
 Bootstrap block, 1-8  
 BOT markers, 1-22  
 Buckets, 3-10, 3-20  
   boundary, 3-22  
   definition, 2-1  
   reclaiming, 3-20, 10-28  
 Bucket size options, 4-32, A-1  
   considering performance, 3-26  
   for indexed files, 7-21  
   for relative files, 7-20  
   relative to index depth, 3-25  
   with multiple areas, 3-24  
 Bucket splits, 3-10, 3-23, 9-13  
   cleaning up, 10-28  
   minimizing, 3-26  
 BUCKET\_SIZE attribute, 4-32, 7-20, 7-21  
 Buffer areas, requirement for Get service, 8-2  
 Buffer caches, 7-4, 7-20  
   for storing index levels, 7-21  
   types, 7-22  
   using with multistreaming, 7-4  
 Buffered I/O, byte count quota, 9-8  
 Buffering techniques, 7-17 to 7-25  
 Buffer-offset length field, 1-33  
 Buffers  
   See also Global buffers  
   I/O, 3-2, 7-18  
   key, 9-13, 9-15, 9-18  
   local, 3-13, 3-28, 7-22  
   multiple, 3-11  
   number of, 3-14, 3-27  
   record header, 9-17, 9-19, 9-20  
   selecting for optimum performance, 7-18 to 7-20  
   space allocation, 7-18  
   user, 9-17, 9-18

/BUFFER\_COUNT qualifier, 7-20, 7-21, 7-22  
 Bytes, 1-1

## C

C, sample search key option program, 8-10  
 Caches  
   buffer, 7-4  
     for file sharing, 9-6  
     global, 7-23  
     specifying as read-only, 7-24  
     with multiple buffers, 9-9  
   memory, 3-14, 3-16, 3-18, 3-27  
     for file sharing, 3-17  
     for random processing, 3-17  
     for storing index, 3-26  
     relative to bucket size, 3-26  
   process local, 3-12  
 Calling FDL\$PARSE and FDL\$RELEASE from a Pascal program, 4-13  
 Carriage return terminator for stream records, 2-13  
 CARRIAGE\_CONTROL attribute, 4-34  
 CD-ROM (compact disc read-only memory), 1-5, 1-6  
   concepts, 1-14  
   formats, 1-14  
   using Digital System Identifiers, 1-15  
   volume structure, 1-14  
 Cells  
   fixed-length, 3-15  
   record structure and, 10-15  
 /CHECK qualifier, 10-1  
 Check report, 10-1, 10-5  
 Clusters, disk allocation, 1-7  
 COBOL  
   calling CONVERT routines from, 4-29  
   calling FDL\$CREATE from, 4-17  
 Command procedures, 1-34  
 Completion status code field, 5-25  
 Compound characters, 5-6  
 Compound documents, 4-19  
 Concurrent Access, global section, 7-24  
 Connect service, 8-5  
   asynchronous operations and, 8-19  
   effect on next-record position, 8-17  
 Contiguity, 10-27  
   FAB and XAB fields, 3-8  
 CONTIGUOUS attribute, 3-24, 4-35  
 Contiguous-best-try option, 4-35  
 Contiguous-best-try request, 3-8  
 Contiguous option, 4-35  
 Contiguous request, 3-8  
 CONTIN.SYS file, 1-10  
 Continuation files, 1-10  
 CONTROL\_FIELD\_SIZE attribute, 4-33

Convert/Reclaim utility (CONVERT/RECLAIM),  
 1–38, 3–19  
 using with Prolog 3 files, 3–20, 10–28

Convert utility (CONVERT), 1–37, 9–8  
 creating data files, 4–15, 4–16  
 making a file contiguous, 10–28  
 populating a file, 4–27  
 reorganizing files, 10–28  
 reorganizing noncontiguous files, 3–27, 10–28  
 using with Prolog 3 files, 3–20  
 with corrupted files, 10–1, 10–2  
 with FDL files, 4–2  
 with Prolog 1 and Prolog 2 files, 3–19

COPY command  
 /CONTIGUOUS qualifier, 9–8, 10–27

Core image file, 1–10

CORIMG.SYS file, 1–10

Count field for variable-length records, 2–9

Create/FDL utility (CREATE/FDL), 1–39, 4–2,  
 4–16  
 maintaining files, 10–1

Create-if option, 4–15, 4–31, 5–22

/CREATE qualifier, 4–10

Create service, 4–15, 5–22  
 for process-permanent files, 6–22

CREATE\_IF attribute, 4–31

Creation date field, 1–30  
 zero creation date, 1–31

Creation-time options  
 contiguous space allocation, 3–13  
 defining file characteristics, 4–32  
 using RMS, 4–31  
 using the Edit/FDL utility, 4–2

Ctrl/Z key sequence, 4–3

Current context  
 current-record position, 8–16 to 8–17  
 listed for OpenVMS record management  
 services, 8–15  
 next-record position, 8–17

Current-record position, 8–3, 8–4

Cylinders, 1–12, 3–10  
 boundary, 3–16  
 options for, 4–35

## D

---

DATA\_BUCKET structure, 10–15, 10–18

Data compression, 3–19

Data files  
 creating, 4–15  
 creating with FDL\$CREATE routine, 4–13,  
 4–16  
 reorganizing, 10–27

Data reliability, 9–11

Data storage, file organization and, 3–2

Data types, 3–19

DATA\_AREA attribute, 3–25

Date-information option, 4–32

DATE primary, 4–32

DCL commands  
 for Analyze/RMS\_File utility, 10–11  
 for the Edit/FDL utility, 4–3

DCL interface for enabling RMS statistics  
 gathering, 3–29

Deadlock detection, record locking, 7–17

Default extension option, 4–35

Default extension quantity  
 \$CREATE fixing of value, 3–7  
 determining factors, 3–7  
 file, 3–5  
 for multiple area file, 3–6  
 how determined for indexed files, 3–6  
 process, 3–5  
 set permanently using FAB and XAB, 3–6  
 set permanently with FDL editor, 3–6  
 setting with DCL, 3–7  
 setting with VOLUME/EXTENSION=n, 3–8  
 specified by RMS, 3–5  
 system, 3–5  
 volume, 3–5

Default file specifications, 6–1 to 6–4, 9–6

Deferred-write processing, 9–8

DEFERRED\_WRITE attribute, 7–21, 7–22

DEFINE command, 6–14  
 /TRANSLATION\_ATTRIBUTES qualifier, 5–20

Defining symbols to USEROPEN routine, 5–23

DELETE attribute, 7–3

DELETE command, 10–25

Delete service, 8–2, 8–4  
 high-level language equivalents, 8–2  
 run-time options, 9–21

Design graphics mode, 4–11

Design mnemonic, 4–13

Device component, 5–3

DID-abbreviated directories, 6–19

Direct access mode, 1–2

Directories, 6–11

DIRECTORY/FULL command for checking RMS  
 statistics status, 3–29

Directory component, 5–8

Directory specifications  
 normal, 6–11 to 6–13  
 rooted, 6–14 to 6–18

Directory trees, 6–12

DIRECTORY\_ENTRY attribute, 4–32

Disconnect service, 8–5

Disks  
 See also CD-ROM  
 basic concepts, 1–3

Disk structure  
 Files–11, 1–8

Double tape mark, 1–22

DOWN command, 10–11, 10–12  
Dual format, ISO 9660 CD and Files–11 CD, 1–4  
DUMP command, 10–11  
Duplicate keys, null key processing, 3–22

## E

EDIT/ACL command, 4–27  
Edit/FDL utility (EDIT/FDL), 1–39

- calculating bucket size, 3–16, 3–26
- calculating extension size, 9–7
- commands, 4–3
- contiguous files, 3–4
- creating areas for index structures, 3–24
- creating FDL files, 4–2, 4–5
- default value, 4–11
- invoking a script, 4–4
- optimization algorithms, A–1
- Optimize script, 10–1, 10–22
- prompt, 4–10
- specifying run-time options, 9–1 to 9–5

Empty fixed-length file cells, effect on sequential search of relative files, 2–3  
End-of-tape markers

- See EOT markers

EOF (end-of-file), label, 1–22  
EOT markers, 1–22  
EOV (end-of-volume), label, 1–22  
Equal-or-next key option, 8–8, 8–9  
Equivalence strings, 6–4  
Erase service, 5–22  
Error checking, 10–1  
Exact key match, 8–12  
EXACT\_POSITIONING attribute, 4–36  
EXIT command, 10–11  
Expanded string, 6–4  
Expiration date field, 1–30  
Extend contiguity options and controls, 3–8  
Extended attribute blocks

- See XABs

Extended character set, 5–4  
Extending a file, 3–4 to 3–9  
Extending RMS subdirectories, 6–18  
Extend operations, 3–4 to 3–9  
Extend placement controls for various file organizations, 3–8  
Extends

- See also Auto extends
- invoking by way of \$EXTEND service, 3–5
- placement and contiguity options, 3–8
- two methods, 3–5

/EXTEND\_QUANTITY qualifier, 9–7  
EXTENSION attribute, 4–36  
Extension size, A–1

- calculating, 9–7
- performance, 9–7, 9–8

Extents, 1–3, 1–7, 9–7

## F

FAB\$B\_BKS field, 3–25, 4–32, 7–20, 7–21  
FAB\$B\_BLS field, 4–32  
FAB\$B\_DNS field, 9–7  
FAB\$B\_FAC field, 9–6

- options, 7–3

FAB\$B\_FNS field, 6–5, 9–6  
FAB\$B\_FSZ field, 4–33  
FAB\$B\_ORG field, 4–32  
FAB\$B\_RAT field, 4–34  
FAB\$B\_RFM field, 4–34  
FAB\$B\_RTV field, 9–8, 9–9  
FAB\$B\_SHR field, 9–6

- FAB\$V\_MSE option, 7–24
- FAB\$V\_SHRGET option, 7–24
- FAB\$V\_UPI option, 7–6
- list of options, 7–4

FAB\$L\_ALQ field, 4–35  
FAB\$L\_DNA field, 6–3, 9–7  
FAB\$L\_FNA field, 6–3, 6–5, 9–6  
FAB\$L\_FOP field, 4–31

- FAB\$V\_CBT option, 4–35
- FAB\$V\_CTG option, 4–35
- FAB\$V\_DFW option, 3–17, 3–18, 3–27, 3–28, 7–21, 7–22, 9–8
- FAB\$V\_MXV option, 4–31
- FAB\$V\_NAM option, 6–5
- FAB\$V\_NEF option, 8–16, 8–17
- FAB\$V\_OFFP option, 6–8, 6–9, 6–10
- FAB\$V\_PPF option, 6–21
- FAB\$V\_RCK option, 9–11
- FAB\$V\_SQO option, 9–10
- FAB\$V\_TMP option, 4–32
- FAB\$V\_UFO option, 7–4, 9–14
- FAB\$V\_WCK option, 9–11

FAB\$L\_MRN field, 4–33  
FAB\$L\_MRS field, 4–33  
FAB\$L\_NAM field, 6–8, 9–7  
FAB\$L\_NAML field, 6–8  
FAB\$L\_STV field, 9–14  
FAB\$V\_CTG option, problem with fragmented disk, 3–9  
FAB\$W\_DEQ field, 4–36, 9–7, 9–8  
FAB\$W\_GBC field, 7–19, 7–23, 9–9  
\$FABDEF macro, 5–23  
FABs (file access blocks), 1–32, 1–36, 4–1  
Fast-delete option, 8–4, 9–8  
FDL (File Definition Language), 1–35, 3–16, 4–2

- attributes, 4–2
- predefined attributes using FDL\$PARSE routine, 9–1
- scripts, 4–2
- syntax, 4–2

- FDL AREA section, 3–24
  - BEST\_TRY\_CONTIGUOUS attribute, 4–35
  - EXACT\_POSITIONING attribute, 4–36
  - POSITION attribute, 4–35
  - VOLUME attribute, 4–36
- FDL CONNECT section
  - ASYNCHRONOUS attribute, 9–8, 9–15, 9–18, 9–20, 9–21
  - DELETE\_ON\_CLOSE attribute, 9–12
  - END\_OF\_FILE attribute, 9–10
  - FAST\_DELETE attribute, 9–8, 9–12, 9–21
  - FILL\_BUCKETS attribute, 9–13, 9–18
  - GLOBAL\_BUFFER\_COUNT attribute, 9–9
  - KEY\_GREATER\_EQUAL attribute, 8–8, 8–9, 9–12, 9–15
  - KEY\_GREATER\_THAN attribute, 8–8, 8–9, 9–12, 9–15
  - KEY\_LIMIT attribute, 9–13, 9–16
  - KEY\_OF\_REFERENCE attribute, 9–13, 9–15
  - LOCATE\_MODE attribute, 9–9, 9–16
  - LOCK\_ON\_READ attribute, 7–13, 9–16
  - LOCK\_ON\_WRITE attribute, 7–13, 9–16, 9–19
  - MANUAL\_LOCKING attribute, 9–16
  - MANUAL\_UNLOCKING attribute, 7–16
  - MULTIBLOCK\_COUNT attribute, 3–14, 7–20, 9–9
  - MULTIBUFFER\_COUNT attribute, 3–14, 3–16, 3–27, 7–19 to 7–21, 9–9
  - NOLOCK attribute, 7–13, 9–15
  - NONEXISTENT\_RECORD attribute, 7–16, 8–8, 9–16
  - READ\_AHEAD attribute, 9–9, 9–16
  - READ REGARDLESS attribute, 7–14, 9–17
  - TIMEOUT\_PERIOD attribute, 7–14, 9–17, 9–19
  - TRUNCATE\_ON\_PUT attribute, 9–10, 9–20
  - UPDATE\_IF attribute, 8–7, 9–11, 9–20
  - WAIT\_FOR\_RECORD attribute, 7–14, 9–18
  - WRITE\_BEHIND attribute, 9–10, 9–20
- FDL files
  - creating, 4–2
  - creating data files, 4–15
  - creating with FDL\$GENERATE routine, 4–13
  - designing, 4–10
  - examining with ANALYZE/RMS\_FILE, 10–1
  - generating from a data file, 10–22
- FDL FILE section
  - ALLOCATION attribute, 3–4, 3–25, 4–35
  - BEST\_TRY\_CONTIGUOUS attribute, 3–4, 4–35
  - BUCKET\_SIZE attribute, 3–16, 3–25, 4–32, 7–20, 7–21
  - CONTIGUOUS attribute, 3–4, 3–25, 4–35
  - CONTROL\_FIELD\_SIZE attribute, 4–33
  - CREATE\_IF attribute, 4–31
  - DEFAULT\_NAME attribute, 6–3, 9–7
  - DEFERRED\_WRITE attribute, 3–17, 3–27, 7–21, 7–22, 9–8
- FDL FILE section (cont'd)
  - DIRECTORY\_ENTRY attribute, 4–32
  - EXTENSION attribute, 4–36, 9–7, 9–8
  - GLOBAL\_BUFFER\_COUNT attribute, 3–13, 7–19, 7–23
  - MAXIMIZE\_VERSION attribute, 4–31
  - MAX\_RECORD\_NUMBER attribute, 4–33
  - MT\_BLOCK\_SIZE attribute, 4–32
  - MT\_CLOSE\_REWIND attribute, 9–14
  - MT\_CURRENT\_POSITION attribute, 9–14
  - MT\_NOT\_EOF attribute, 9–13
  - MT\_OPEN\_REWIND attribute, 9–14
  - MT\_PROTECTION attribute, 4–33
  - NAME attribute, 6–3, 9–6
  - NON\_FILE\_STRUCTURED attribute, 9–14
  - ORGANIZATION attribute, 4–32
  - OWNER attribute, 4–33
  - PRINT\_ON\_CLOSE attribute, 9–12
  - PROTECTION attribute, 4–33
  - READ\_CHECK attribute, 9–11
  - REVISION attribute, 4–32
  - SEQUENTIAL\_ONLY attribute, 9–10
  - SUBMIT\_ON\_CLOSE attribute, 9–12
  - SUPERSEDE attribute, 4–31
  - TEMPORARY attribute, 4–31
  - USER\_FILE\_OPEN attribute, 7–4, 9–14
  - WINDOW\_SIZE attribute, 9–8, 9–9
  - WRITE\_CHECK attribute, 9–11
- FDL KEY section, 4–33
  - DATA\_AREA attribute, 3–25
  - DATA\_FILL attribute, 3–26
  - INDEX\_AREA attribute, 3–25
  - INDEX\_FILL attribute, 3–26
  - LEVEL1\_INDEX\_AREA attribute, 3–25
  - TYPE attribute, 3–23
- /FDL qualifier, 10–22
- FDL RECORD section
  - BLOCK\_SPAN attribute, 3–13, 4–33, 4–34
  - CARRIAGE\_CONTROL attribute, 4–34
  - CARRIAGE\_RETURN attribute, 4–33
  - count field format attribute, 4–33
  - FORMAT attribute, 4–34
  - Fortran attribute, 4–33
  - Fortran carriage control attribute, 4–33
  - MSB\_RECORD\_LENGTH attribute, 4–33
  - PRINT attribute, 4–33
  - PRINT carriage control attribute, 4–33
  - SIZE attribute, 4–33
- FDL routines
  - FDL\$CREATE routine, 4–13, 4–16, 6–3
  - FDL\$GENERATE routine, 4–13
  - FDL\$PARSE routine, 4–13, 6–3, 9–1
    - example, 9–22 to 9–23
  - FDL\$RELEASE routine, 4–13, 6–3, 9–1
    - example, 9–22 to 9–23
- FDL SHARING attributes, 7–4, 7–6, 7–24

- FID-abbreviated names, 6–20
  - restrictions, 6–21
- Fields, 1–1
- File access blocks (FAB)
  - See FABs
- File access sensing tags, 4–23
- FILE ATTRIBUTES structure, 10–12, 10–15, 10–17
- File characteristics, 4–31, 4–32
- File corruption, 10–2
- File default extension quantity, 3–5
  - with multiple areas, 3–7
- File Definition Language
  - See FDL
- File design attributes, 3–4
- File disposition, 9–11
- File extends
  - See Extends
- File header labels
  - See Header labels
- File headers, 1–9
  - Files–11 structure, 1–9
- FILE HEADER structure, 10–12, 10–15, 10–17
- File identifier field, 1–28
- File names, 5–9
- File-opening options
  - See also Creation-time options
  - adding records, 9–10, 9–11
  - data reliability, 9–11
  - file access and sharing, 9–6
  - file disposition, 9–11
  - file performance, 9–7 to 9–10
  - file specification, 9–6, 9–7
  - for indexed files, 9–12, 9–13
  - for magnetic tape processing, 9–13, 9–14
  - for nonstandard file processing, 9–14
  - record access, 9–10
- File organization
  - See also Indexed files; Relative files; Sequential files
- File organization option, 4–32
- File positioning, 4–34
- File processing
  - many files, 5–28 to 5–29
  - nonstandard file, 9–14
  - single file, 5–27 to 5–28
- File protection, 4–32
- Files, 1–1
  - See also File protection; File sharing; File structures; Indexed files
  - accessing
    - category summary, 4–26
    - defaults, 7–5
    - in an OpenVMS Cluster, 3–33
    - options, 4–26
  - aligning, 3–16
- Files (cont'd)
  - contiguity, 3–4, 3–25
  - extensions, 3–24
  - FDL, 4–2, 4–15, 10–1, 10–22
  - header, 3–15, 3–18, 10–11
  - initial allocation, 3–4
  - internal structure, 10–1
  - locking in an OpenVMS Cluster, 3–33
  - magnetic tape, 1–19
  - organization, 1–2, 2–13, 2–14
    - selecting, 2–1
  - reserved, list of, 1–8
  - specifying one or many, 5–29
  - volume configurations, 1–24
- Files, truncating, 3–9
- Files–11 CD, on dual format CDs, 1–4
- Files–11 disk structures, 1–8
  - file headers, 1–9
  - home block, 1–8
  - levels compared, 1–11
  - reserved files, 1–8
- Files–11 On-Disk Structure
  - comparison of ODS Levels 1, 2, and 5, 1–4
  - definition, 1–3
- File section number field, 1–30
- File sequence number field, 1–30
- File-set identifier field, 1–30
- File sharing, 3–12, 9–6
  - compatibility with subsequent record access, 7–5 to 7–6
  - defaults, 7–5
  - interlocked interprocess, 7–2, 7–5 to 7–6
  - multistreaming, 7–2, 7–4
  - no-access function, 7–4
  - options, 7–4
  - user-interlocked interprocess, 7–2, 7–4, 7–6, 7–7
- File specification parsing, 6–4 to 6–11
  - conventions used by RMS, 6–4 to 6–11
  - for input file, 6–9
  - for output file, 6–10
  - for related file, 6–8 to 6–9
  - logical name, 6–5 to 6–6
  - search list, 6–7 to 6–8
- File specifications, 1–28
  - See also Default file specifications
  - applicable services and routines, 5–21 to 5–27
  - components, 5–1, 5–2
  - default, 5–17, 6–1 to 6–4, 9–6
  - directory, 6–11 to 6–18
  - format, 5–1 to 5–14, 6–5, 6–6
  - for remote file access, 5–3, 5–21
  - input, 6–9
  - length limits, 5–12
  - output, 6–10
  - preprocessing, 5–21
  - primary, 6–1 to 6–4, 9–6
  - program supplied, 6–1 to 6–4

- File specifications (cont'd)
  - related, 6-1 to 6-4, 6-8, 6-9, 9-7
  - using logical name, 6-5, 6-6
  - using name block, 5-21
  - using search lists, 5-21 to 5-29, 6-7, 6-8
  - using SYS\$DISK, 6-2
  - using wildcard characters, 5-21 to 5-29
- File specifications parsing, 5-21, 5-22
- File structures, 10-11
  - options on OpenVMS systems, 1-3
- File tags
  - creating, 4-20
  - requirement for, 4-19
  - using, 4-19
- File tuning
  - See Tuning
- File type field, 1-28
- File types, 5-9
- File versions, 5-9
- FILE\_ID option, 4-36
- FILE\_MONITORING attribute, 3-29
- FILE\_NAME option, 4-36
- Fill factor, 3-26
- Find service
  - compared with Get service, 8-2
  - effect on next-record position, 8-17
  - high-level language equivalents, 8-1
  - improved performance, 8-3
  - key matches and, 8-11
  - requirement for end-of-file test, 8-3
  - run-time options, 9-14 to 9-18
- FIRST command, 10-11
- Fixed-length cells, 3-15
- Fixed-length control fields, 3-15
  - size option, 4-33
- Fixed-length records, 1-31
- Flush service, 7-6, 8-5
- FORMAT attribute, 4-34
- Formats for ANSI magnetic tape volumes, 1-20
- Fortran program example
  - calling the FDL\$CREATE Routine, 4-17
  - remote file access, 5-18
  - using the CONVERT Routines, 4-27
- Fragmented files, 3-4 to 3-9
- Free service, 8-5

## G

---

- GBLPAGES system parameter, 1-40
- GBLPAGFIL system parameter, 1-40
- GBLSECTIONS system parameter, 1-40
- Generation version number, 1-30
- Generic key match, 8-12
- GET attribute, 7-4, 7-24
- Get service
  - compared with Find service, 8-2
  - current-record and, 8-16
  - effect on next-record position, 8-17

- Get service (cont'd)
  - high-level language equivalents, 8-1
  - requirement for end-of-file test, 8-3
  - run-time options, 9-14 to 9-18
- Global buffer counts, example of run-time specification, 5-23 to 5-25
- Global buffer performance enhancements, 7-24
- Global buffers, 1-40, 3-12, 3-28
  - number, 7-19
  - performance, 9-9
  - restricted use, 7-23
  - with deferred-write option, 3-13
  - with indexed file, 7-22
  - with relative file, 7-22
  - with shared file, 7-22 to 7-25
  - with shared sequential file, 3-14
- Global buffer sizes
  - for shared sequential file operations, 3-14, 7-24
- Global page tables, 1-40
- Global section, concurrent access, 7-24
- Global sections, 1-40
- /GLOBAL\_BUFFERS qualifier, 7-23
- GLOBAL\_BUFFER\_COUNT attribute, 7-19, 7-23

## H

---

- Hard-positioning option, 4-36
- Hardware errors, 10-2
- Header labels, 1-22
  - HDR1 label, 1-28
    - accessibility field, 1-31
    - creation date field, 1-30
    - expiration date field, 1-30
    - file identifier field, 1-28
    - file section number field, 1-30
    - file sequence number field, 1-30
    - file-set identifier field, 1-30
    - generation number field, 1-30
    - generation version-number field, 1-30
  - HDR2 label, 1-28, 1-31
    - block length field, 1-32
    - buffer-offset length field, 1-33
    - record format field, 1-31
    - record length field, 1-33
    - system-dependent field, 1-33
  - HDR3 label, 1-28
    - RMS attributes field, 1-34
  - HDR4 label, 1-28, 1-34
- HELP command, 10-11
- Home blocks, 1-8

## I

I/O and performance, 3-1  
I/O unit, 3-9 to 3-13  
Identifier fields  
  file, 1-28  
  file-set, 1-30  
  implementation, 1-27  
  owner, 1-27  
  volume, 1-27  
Image activations, 5-17  
INDEX BUCKET structure, 10-18  
Index compression  
  prohibition against using, 4-8  
  restrictions, 3-2, 3-19, 3-26  
Index depth, A-2  
Indexed files, 2-19, 3-18  
  advantages of using, 2-25  
  allocating, A-1  
  alternate key, 2-20  
  bitmap, 1-9  
  bucket size, 3-10, 3-25, 7-21, A-1  
  buffering, 7-21, 7-22  
  compression, 3-2, 3-19, 3-26  
  deferred-write option with, 3-12  
  designing, 3-18 to 3-28  
  disadvantages of using, 2-25  
  examining, 10-17  
  extend size, 3-6  
  fill factor, 3-10  
  global buffers, 7-22  
  INDEXF.SYS, 1-8  
  key type, 2-20  
  making contiguous, 10-28  
  optimizing performance, 3-18 to 3-28  
  organization, 1-2  
  primary key, 2-20  
  Prolog 1 files and Prolog 2 files, 3-19  
  reclaiming buckets in, 10-28  
  record access, 8-9 to 8-14  
  redesigning, 10-25  
  reorganizing, 10-28  
  run-time options, 9-12, 9-13  
  selection of default extension quantity, 3-6  
  tuning, 3-18 to 3-28  
  with global buffers, 3-28  
/INDEXED qualifier, 7-22  
Index entries, ordering, 2-5  
Index levels, number of, A-2  
Index structures, 3-18, 3-25  
  Level 0, 3-20  
  Level 1, 3-20  
  primary, 3-20  
INDEX\_AREA attribute, 3-25  
INITIALIZE command, window size and, 9-8

/INTERACTIVE qualifier, 10-11  
Internal buffers, 8-3  
Interrecord gap  
  See IRG  
INVOKE command, 4-5  
IRG (interrecord gap), 1-18  
ISO 9660 CD, file format, 1-4  
ISO 9660 standard, resolution of incompatibilities  
  with OpenVMS, 1-15

## K

Key 0, 3-20  
Key buffers, 8-3, 9-13, 9-18  
Key-characteristics option, 4-33  
Key compression  
  front, 3-19  
  prohibition against using, 4-8  
  rear, 3-19  
  restrictions, 3-2, 3-19, 3-26  
KEY DESCRIPTOR structure, 10-17  
Key greater than option  
  See Next-key option  
Key greater than or equal option  
  See Equal-or-next-key option  
Key matches  
  approximate, 8-12  
  exact, 8-12  
  generic, 8-12, 8-13  
  generic and approximate, 8-13 to 8-14  
Keys (in records)  
  alternate, 3-18, 3-19, 3-23  
  duplicate values, 2-20  
  for Prolog 1 files and Prolog 2 files, 3-19  
  null value, 2-20  
  number of, 3-23  
  primary, 3-20, 3-23  
  segmented, 3-20  
  size, 9-13, 9-16, 9-18  
  used in storing indexed records sequentially,  
    2-5  
Keys of reference, 2-5  
KEY\_GREATER\_EQUAL attribute, 8-8, 8-9  
KEY\_GREATER\_THAN attribute, 8-8, 8-9

## L

Labels  
  ANSI magnetic tape, 1-19, 1-22  
  EOF (end-of-file), 1-34  
  EOV (end-of-volume), 1-34  
  HDR1, 1-28  
  HDR2, 1-31  
  HDR3, 1-34  
  HDR4, 1-34  
  header, 1-27  
  ISO, 1-19

## Labels (cont'd)

- trailer, 1-34
- VOL1, 1-24
- Leading hyphens
  - file names, 5-10
  - subdirectory names, 5-10
- Leading zeros in stream records, 2-13
- LEVEL1\_INDEX\_AREA attribute, 3-25
- LIB\$FIND\_FILE routine, 5-21 to 5-25
- LIB\$STOP routine, 5-25
- Line\_Plot graph, 4-11, A-2
- Local nodes, 5-3
- Locate mode, record retrieval and, 8-2
- Lock-mastering nodes, 3-33
- Lock-requesting nodes, 3-33
- Lock root, 3-33
- LOCK\_ON\_READ attribute, 7-13
- LOCK\_ON\_WRITE attribute, 7-13
- Logical-block-position option, 4-36
- Logical names
  - concealed attribute, 5-20
  - concealed-device, 6-14
  - parsing, 5-11, 5-21
  - rooted-device, 6-14
  - sample program, 5-17, 5-18
  - search lists, 5-20, 6-7, 6-8
  - translation, 5-20, 6-5, 6-6
  - types of, 5-20
- LOGICAL option, 4-36
- Lowercase letters, 5-7

## M

---

- MACRO language, 3-15, 3-18, 3-28, 4-2
  - RMS and, 9-5
- Magnetic tape ancillary control process
  - See MTACP
- Magnetic tape dating, year 2000 readiness, 1-30
- Magnetic tapes
  - basic concepts of, 1-18
  - processing run-time options, 9-13 to 9-14
  - 9-track drive, 1-20
- MANUAL\_UNLOCKING attribute, 7-16
- Master File Directories
  - See MFDs
- MAXIMIZE\_VERSION attribute, 4-31
- Maximum record number option, 4-33
- Maximum record size, indexed file, 3-23
- Maximum record size option, 4-33
- MAX\_RECORD\_NUMBER attribute, 4-33
- Memory
  - cache, 3-14, 3-16, 3-17
  - nonpaged system dynamic, 9-8
  - releasing with the FDL\$RELEASE routine, 4-13

- MFDs (master file directories), 1-10, 6-11
- Modes
  - interactive, 10-11
  - locate performance, 9-9
- MODIFY command, 10-25
  - Edit/FDL utility, A-1
- Modifying records in occupied cells, 2-4
- MONITOR command, for displaying all RMS statistics screens, 3-32
- Monitoring RMS performance using RMS statistics, 3-29
- Monitor utility (MONITOR)
  - analyzing RMS cache statistics display, 3-31
  - for sampling RMS statistics, 3-30
- MOUNT command
  - /BLOCKSIZE qualifier, 1-32
  - /RECORDSIZE qualifier, 1-33
  - window size and, 9-8
- MTACP (magnetic tape ancillary control process), 1-20
- MT\_BLOCK\_SIZE attribute, 4-32
- MT\_PROTECTION attribute, 4-33
- Multiblocks, 3-13
  - count for calculating auto extend, 3-5
  - count to establish global buffer size in shared sequential file operations, 7-24
  - definition, 3-10
  - option, 2-1
  - restriction for use, 3-10
- MULTIBLOCK\_COUNT attribute, 7-20
- Multibuffer count, 3-14, 3-27
- MULTIBUFFER\_COUNT attribute
  - for sequential file, 7-20
  - record access type and, 7-21
- Multifile/multivolume configuration, 1-24
- Multiple areas, advantages, 3-24
- Multiple files on a single tape volume, 1-24
- Multiple File Versions, 5-7
- Multiple services for retrieving records, 8-3
- MULTISTREAM attribute, 7-4

## N

---

- NAM\$B\_RSS field, 6-8
- NAM\$L\_ESA field, 6-4
- NAM\$L\_RLF field, 6-3, 6-8, 9-7
- NAM\$L\_RSA field, 6-3, 6-8
- NAM\$T\_DVI field, 6-5
- NAM\$W\_DID field, 6-5
- NAM\$W\_FID field, 6-5
- \$NAMDEF macro, 5-23
- Name blocks
  - See NAMs
- NAML\$L\_FNB field, 6-11
- NAML\$L\_LONG\_RESULT field, 6-8

NAML\$L\_LONG\_RESULT\_ALLOC field, 6–8  
 NAML\$L\_RLF field, 6–8  
 NAMs (long name blocks), 5–21  
 NAMs (name blocks), 5–25  
   address field, 5–22  
   resulting file specification and, 5–21  
   search list in, 5–22  
   Search service and wildcards, 5–21  
   support by FDL, 5–23  
   support by languages, 5–23  
   wildcard character in, 5–22  
 NEXT command, 10–11 to 10–15  
 Next key option, 8–8, 8–9  
 Next-record position, 8–18  
   use with sequential access, 8–17  
 Next Volume service, 8–5  
 Node component, 5–2  
   local, 5–2  
   remote, 5–2  
 Nodes  
   lock-mastering, 3–33  
   lock-requesting, 3–33  
 NOLOCK attribute, 7–13  
 NONEXISTENT\_RECORD attribute, 7–16, 8–8  
 Nonstandard file processing, run-time options,  
   9–14  
 No query locking, 7–10  
 Normal directory syntax, 6–11 to 6–13  
 Null keys, for improving performance, 3–22

## O

ODS-1  
   comparing with ODS-2, 1–4  
   comparing with ODS-2 and ODS-5, 1–4  
 ODS-1 disks, 3–29  
 ODS-2, comparing with ODS-1 and ODS-5, 1–4  
 ODS-2 on Alpha and VAX systems, 5–12  
 ODS-5 on Alpha systems, 5–13  
 ODS-5 on VAX systems, 5–12  
 On-disk components, 5–4  
   character set, 5–4  
 On-disk representation, 5–5  
 Open-by-name-block option, 5–22, 6–5  
   performance and, 6–6  
 Open service, 5–22  
   for process-permanent files, 6–22  
 OpenVMS Cluster environments, 3–32  
   locking considerations, 3–33  
 Optimization  
   Edit/FDL utility, A–1  
   of indexed files, 10–26  
 ORGANIZATION attribute, 4–32  
 OWNER attribute, 4–33

## P

P0 region, used for RMS buffers, 7–18  
 Parity bit, 1–18  
 Parse service, 5–21 to 5–25  
 Parsing file specifications, 6–4  
   See also File specification parsing  
 Pascal program example, calling FDL\$PARSE and  
   FDL\$RELEASE routines, 4–13  
 Pending bad block log file, 1–10  
 Performance, 3–1  
   asynchronous processing and, 9–8  
   buffers, 9–9  
   deferred-write option, 3–28, 9–8  
   effect of compression, 3–20  
   extension size and, 9–7 to 9–8  
   fast-delete option and, 9–8  
   global buffer count and, 9–9  
   I/O in OpenVMS Cluster, 3–33  
   improving with null keys, 3–22  
   in an OpenVMS Cluster, 3–32  
   locate mode and, 9–9  
   multiblock count, 9–9  
   read-ahead option, 9–9  
   recommendations for an OpenVMS Cluster  
     environment, 3–33  
   sequential access, 9–10  
   using Prolog 3, 3–20  
   window size and, 9–7 to 9–9  
   write-behind option, 9–10  
 Placement of extends, 3–8  
 Pointer retrieval, 9–7  
 POSITION attribute, 4–36  
 Primary attributes, 4–9  
 Primary record structures, 10–18  
 Process default extension quantity, 3–5, 3–7  
 Processes  
   types of resources, 1–40  
     asynchronous system trap limit (ASTLM),  
       1–41  
     buffered I/O limit (BIOLM), 1–41  
     I/O limit (DIOLM), 1–41  
 Process I/O segment, 1–40  
 Processing  
   deferred-write option, 3–18, 3–28  
   options for improving file performance, 3–10  
   read-ahead option, 3–14, 3–15  
   write-behind option, 3–14, 3–15  
 Process-permanent files, 1–40  
   access to, 6–21  
   implications for indirect access, 6–22  
   restriction to gathering RMS statistics, 3–29  
 Process quotas, resource limits, 1–40  
 Programming interface, 4–20  
 PROHIBIT attribute, 7–4

- Prolog 1 files, 3–18
- Prolog 2 files, 3–18
- Prolog 3 files, 3–19, 10–28
- Prolog files, 3–15, 3–18, 3–22
- PROLOG structure, 10–15, 10–17
- Protection
  - access category, 4–26
  - ACL-based, 1–35, 4–26
  - disk and tape volumes, 1–35
  - UIC-based codes, 1–35, 4–26
- PROTECTION attribute, 4–33
- PUT attribute, 7–3, 7–4
- Put service, 8–1, 8–3 to 8–4
  - effect on next-record position, 8–17
  - high-level language equivalents, 8–1
  - run-time options, 9–18 to 9–20

## Q

- Query locking, 7–10
- Queue I/O request system service, 7–4, 9–14
- Queue I/O services, \$QIO call, 1–20

## R

- RAB\$B\_KRF field, 9–13, 9–15
- RAB\$B\_KSZ field, 8–7, 8–8, 8–14, 9–13, 9–16, 9–18
- RAB\$B\_MBC field, 3–14, 7–20, 9–9
- RAB\$B\_MBF field, 3–14, 3–27, 9–9
- RAB\$B\_RAC field
  - RAB\$C\_KEY option, 8–6, 9–10, 9–17, 9–19
  - RAB\$C\_RFA option, 8–6, 9–10, 9–17, 9–19
  - RAB\$C\_SEQ option, 8–6, 9–10, 9–17, 9–19
- RAB\$B\_TMO field, 7–14, 7–15, 9–17
- RAB\$L\_KBF field, 8–7, 8–8, 8–14, 9–13, 9–15, 9–18
- RAB\$L\_RBF field, 9–19, 9–21
- RAB\$L\_RBZ field, 9–19
- RAB\$L\_RHB field, 9–17, 9–19, 9–20
- RAB\$L\_ROP field, 9–6
  - RAB\$V\_ASY option, 8–18, 8–19, 9–8, 9–15, 9–18, 9–20, 9–21
  - RAB\$V\_EOF option, 8–15, 8–17, 9–10
  - RAB\$V\_EQNXT option, 9–12, 9–15
  - RAB\$V\_FDL option, 9–8, 9–12, 9–21
  - RAB\$V\_KGE option, 8–8, 8–9
  - RAB\$V\_KGT option, 8–8, 8–9
  - RAB\$V\_LIM option, 9–13, 9–16
  - RAB\$V\_LOA option, 9–13, 9–18
  - RAB\$V\_LOC option, 9–9, 9–16
  - RAB\$V\_NLK option, 7–13, 9–15
  - RAB\$V\_NXR option, 7–16, 8–8, 9–16
  - RAB\$V\_NXT option, 9–12, 9–15
  - RAB\$V\_RAH option, 3–15, 9–9, 9–16
  - RAB\$V\_REA option, 7–13, 9–16
  - RAB\$V\_RLK option, 7–13, 9–16, 9–19
  - RAB\$V\_RRL option, 7–14, 9–17

- RAB\$L\_ROP field (cont'd)
  - RAB\$V\_TMO option, 7–14, 7–15, 9–17, 9–19
  - RAB\$V\_TPT option, 9–10, 9–20
  - RAB\$V\_UIF option, 8–4, 8–7, 9–11, 9–20
  - RAB\$V\_ULK option, 7–16, 9–16
  - RAB\$V\_WAT option, 7–14, 9–18
  - RAB\$V\_WBH option, 3–15, 9–10, 9–20
- RAB\$L\_UBF field, 9–17
- RAB\$L\_USZ field, 9–18
- RAB\$W\_RBF field, 8–2
- RAB\$W\_RFA field, 8–14, 8–17, 9–17
- RAB\$W\_RSZ field, 8–2, 9–21
- \$RABDEF macro, 5–23
- RABs (record access blocks), 1–36
- Random access
  - by key value, 2–6, 2–7, 8–6, 8–12 to 8–14
  - by relative record number, 2–6 to 2–7, 8–6, 8–7, 8–8
  - by RFA (record file address), 2–7, 8–6, 8–14
  - to indexed files, 2–6, 8–12 to 8–14
  - to relative files, 2–6, 8–8, 8–14
  - to sequential files, 2–6, 8–7, 8–14
  - with multibuffer count, 3–27
- RCW (record control word), 1–32
- Read-mode bucket locking, 7–25
- READ\_REGARDLESS attribute, 7–14
- Record access, 9–6, 9–10
  - See also Access
  - in stream context, 8–15
  - options, 7–3
- Record access blocks
  - See RABs
- Record access modes, 2–2
  - for indexed files, 8–9 to 8–14
  - for relative files, 8–7, 8–9
  - for sequential files, 8–7
  - sequential, 2–2, 8–6, 8–8, 8–12
  - specifying, 8–6, 8–7, 9–10, 9–17, 9–19
- Record buffering
  - See Buffering techniques
- Record buffers, 9–19, 9–20
- Record control word
  - See RCW
- Record file addresses
  - See RFAs
- Record formats, 1–2, 2–8, 3–15
  - fixed-length, 1–2, 1–31, 2–9, 2–10, 3–15, 3–22
  - selecting, 2–1
  - stream, 1–3
  - variable-length, 1–2, 1–31, 2–9, 2–10, 3–15, 3–22
- Record header buffer, 9–17, 9–19, 9–20
- Record length field, 1–33
- Record Management Services
  - See RMS

- Record operation, 8-1 to 8-5
- Record processing, list of services, 8-5
- Record-processing run-time option
  - deleting, 9-21
  - inserting, 9-18 to 9-20
  - retrieving, 9-14 to 9-18
  - updating, 9-20 to 9-21
- Record reference vector
  - See RRV
- Records, 1-1
  - See also Record formats
  - adding, 9-10, 9-11
  - blocking, 1-18
  - contents, 2-1
  - deleting, 8-4, 9-21
  - format options, 4-34
  - inserting, 8-3 to 8-4, 9-18 to 9-20
  - locating, 8-2 to 8-3
  - locking, 9-6
    - deadlock, 7-17
    - use with update operation, 8-3
  - retrieving, 8-2 to 8-3, 9-14 to 9-18
    - sequentially from an indexed file, 2-5
  - updating, 8-4, 9-20, 9-21
- Record stream connection option
  - See File-opening options
- Record streams
  - connecting to a file, 7-2
  - definition, 7-2
- Record transfer mode
  - locate, 7-17
  - move, 7-17
- RECORD\_IO attribute, 7-3
- Related-file-position option, 4-36
- Relative file extend size
  - initial value, 3-5
  - maximized value, 3-6
- Relative files, 2-17
  - advantages of using, 2-18
  - allocating, A-1
  - bucket sizes, 3-10, 3-16, 7-20, A-1
  - buffering, 7-20 to 7-21
  - deferred-write option with, 3-12
  - designing, 3-15 to 3-18
  - disadvantages of using, 2-18
  - examining, 10-15, 10-16
  - maximum record size, 3-15
  - optimizing performance, 3-15 to 3-18
  - organization, 1-2
  - record access, 8-7 to 8-9, 8-14
  - tuning, 3-15 to 3-18
    - with global buffers, 3-17
- /RELATIVE qualifier, 7-21
- Relative record number, 1-2, 3-15
- Release service, 8-5
- Remote file access
  - See also File specifications
  - Fortran program example, 5-18
- Remote nodes, 5-3
- Rename service, 5-22
- Repeating characters in compression, 3-19
- REST command, 10-11, 10-12, 10-15
- Restrictions
  - tilde (~), 5-10
- Restriction with extended file names, 5-10
- Retrieval pointer, 9-7
- Retrieving records sequentially from an indexed file, 2-5
- Return key, interactive mode, 10-11
- Reverse-search key options, 8-9, 8-17
- REVISION attribute, 4-32
- Revision data, 9-10
- Rewind service, 8-5
  - effect on next-record position, 8-18
- RFAs (record file addresses), 1-2, 8-14, 9-17, 10-28
  - access, 10-28
  - created by CONVERT, 3-19
  - use of table for rapid access, 8-3
- RMS, 1-20, 1-31, 1-32, 1-35
  - allocating buffers, 3-14, 3-17
  - attributes, 1-33, 1-34
  - bucket splits, 3-24
  - calculating extension size, 3-13
  - connect-time options, 4-2
  - control blocks, 1-36, 4-13
  - creation-time options, 4-2, 4-15
  - data structures, 1-36
  - deferred-write operation, 3-18, 3-28
  - image activation, 5-17
  - in indexed files, 3-18
  - MACRO parameter, 3-15
  - option selection, 9-1
  - overflow into P0, 7-18
  - placing file information in prologs, 3-18
  - statistics
    - cache display, 3-31
    - determining when enabled, 3-29
    - displaying, 3-30
    - enabling gathering, 3-29
    - example of using, 3-30
    - impact on resources associated with global sections, 3-29
    - restrictions to gathering, 3-29
    - using to improve performance, 3-30
- truncation
  - error, 3-9
  - requesting, 3-9
    - use with large extends, 3-9
  - use of multiblocks, 3-14
  - using with languages, 1-35
  - utilities
    - ANALYZE/RMS\_FILE, 1-37

RMS  
 utilities (cont'd)  
   CONVERT, 1-38  
   CONVERT/RECLAIM, 1-38  
   CREATE/FDL, 1-39  
   EDIT/FDL, 1-39  
 with Prolog 3 files, 10-28  
 RMS global buffer management, scalability, 7-24  
 RMS interface, 5-1  
 RMS representation, 5-5  
 RMS subdirectories, extending, 6-18  
 RMS\_GBLBUFQUO system parameter, 1-40  
 Root component, 5-8  
 Rooted-device logical names, 6-14  
 Rooted-directory specifications  
   concatenated, 6-15 to 6-17  
   syntax, 6-14 to 6-18  
 Root level, 3-20  
 Rotational latency, 1-12  
 RRV (record reference vector), 3-10, 3-23  
 RSX systems, use of ODS-1 file structure with,  
 1-4  
 Run-time options  
   example, 9-22 to 9-23  
   specifying, 9-1 to 9-5

**S**

---

Save sets, 10-29  
 Scalability, RMS global buffer management, 7-24  
 /SCRIPT qualifier, 10-26  
 Scripts  
   list of, 4-4  
   Optimize, 10-1  
   Touch-up, 10-25  
 Search key option example program, 8-10  
 Search key options, 8-8 to 8-11  
 Search key types, 8-9  
 Search lists  
   See also File specifications  
   definition, 5-20  
   example, 5-27, 5-28  
   multiple file locations, 5-20, 5-21  
   translations, 6-7, 6-8  
 Search service, 5-21 to 5-25  
 Secondary completion status value field, 5-25  
 Secondary index data record  
   See SIDR  
 Secondary indexes  
   See Alternate indexes  
 Secondary services, effect on next-record position,  
 8-18  
 Sectors, 1-12  
 Seek time, 1-12  
 Segmented keys, 2-20

Semantics tags  
 See File tags  
 Sequential access, 1-2, 8-6  
   to indexed files, 2-5, 8-12  
   to relative files, 2-3, 8-8  
   use with sequential files, 2-3, 8-7  
   with multibuffer count, 3-27  
 Sequential cell search in relative files, 2-3  
 Sequential files, 2-15  
   advantages of using, 2-16  
   allocating, A-1  
   buffering, 7-20  
   designing, 3-13 to 3-15  
   disadvantages of using, 2-16  
   examining, 10-12, 10-13  
   optimizing performance, 3-13 to 3-15  
   read-ahead and write-behind, 3-13  
   record access, 8-7, 8-14  
   tuning, 3-13 to 3-15  
 /SEQUENTIAL qualifier, 7-20  
 SET DEFAULT command, 6-13, 6-14  
   /TRANSLATION\_ATTRIBUTES qualifier, 6-14  
 SET FILE/EXTENSION=n command, 3-7  
 SET FILE/SEMANTICS command, example of  
   tagging file, 4-19  
 SET FILE/STATISTICS command, 3-29  
 SET FILE command  
   /ACL qualifier, 4-27  
   /GLOBAL\_BUFFERS qualifier, 3-13, 7-23  
 SET PROTECTION command, 4-26  
 SET RMS\_DEFAULT command, 3-14  
   /BUFFER\_COUNT qualifier, 3-11, 3-14, 3-16,  
   7-20, 7-21, 7-22  
   /EXTEND\_QUANTITY qualifier, 9-7  
   /INDEXED qualifier, 7-22  
   /RELATIVE/BUFFER\_COUNT qualifier, 3-17  
   /RELATIVE qualifier, 7-21  
   /SEQUENTIAL qualifier, 7-20  
 Shared access, 3-3  
 Shared files  
   See File sharing  
 Shared sequential file operations, establishing  
   global buffer size, 3-14, 7-24  
 SHOW RMS\_DEFAULT command, 3-11, 3-17  
   current default extension size, 9-7  
   current process-default buffer count, 7-20 to  
   7-22  
 SIDR (secondary index data record), 3-18, 3-22,  
 10-21  
 Signaling errors, example in a VAX MACRO  
 program, 5-25  
 Simple characters, 5-6  
 Single file on a single tape volume, 1-24  
 Single file on multiple tape volumes, 1-24  
 SIZE attribute, 4-33

- Software errors, 10–2
- Software Performance Reports
  - See SPRs
- Sort order, effect on record retrieval, 2–5
- Spanning block boundaries, stream records, 2–13
- Speed
  - See Performance
- Spool-on-close option, 9–12
- SPRs (Software Performance Reports), 10–2
- /STATISTICS qualifier, 10–6
- Statistics reports, 10–6, 10–10
- Sticky defaults for file specifications, 6–8
- Storage bitmap file, 1–9
- Stored semantics file attribute, 4–19
  - See also File tags
- Storing records sequentially in a relative file, 2–4
- STR\$GET1\_DX routine, 5–23
- Stream record format, 2–13
  - set of terminating characters, 2–13
- Stream record type, 1–32
- STREAM\_CR format, 2–13
- STREAM\_LF format, 2–13
- Structural level of a disk device
  - determining, 5–14
- Subdirectory depths, maximum, 5–13
- SUPERSEDE attribute, 4–31
- Supersede option, 4–31, 5–22
- Surface\_Plot graph, 4–11, A–2
- Synchronous operations, 8–18
- SYS\$CVT\_FILENAME system service, 5–8
- SYS\$DISK logical name, applied to file
  - specification, 6–2
- SYS\$OUTPUT logical name, for check report, 10–1
- SYS\$SETDDIR system service, 6–13
- System default extension quantity, 3–5, 3–7
- System-dependent field, 1–33
- System management, 3–11
  - image activation, 5–17
- System parameters, limiting global buffers, 1–40
- System resources, 1–40

## T

---

### Tags

- See File tags
- Tape files, 1–19
- Tape marks
  - BOT, 1–22
  - EOT, 1–22
- Tape processing, run-time options, 9–13 to 9–14
- TEMPORARY, delete option, 4–31
- TEMPORARY option, 4–31
- Terminator characters, used to delimit stream
  - records, 2–13

- Tilde (~)
  - first file name character, 5–10
- TIMEOUT\_PERIOD attribute, 7–14
- TOP command, 10–11
- Track, 1–12, 3–16
- Trailer labels, 1–22, 1–34
- /TRANSLATION\_ATTRIBUTES qualifier, 5–20, 6–14
- Tree structures
  - of indexed files, 10–17
  - of relative files, 10–15
  - of sequential files, 10–12
- TRUNCATE attribute, 7–3
- Truncate-on-put option, access requirement, 7–7
- Truncate service, 8–4, 8–5
  - effect on next-record position, 8–17
- Truncating a file, access limitation, 3–9
- Truncation errors, 3–9
- Tuning, 3–3, 10–24
  - indexed files, 3–18
  - relative files, 3–15
  - sequential files, 3–13

## U

---

- UIC-based protection, 4–26
- UICs (user identification codes), 1–35
- UNDEFINED format, 2–13
- UP command, 10–11
- UPDATE attribute, 7–3, 7–4
- Update-if option, 8–3 to 8–4
- Update operation, 3–13
- Update service, 8–1, 8–4
  - high-level language equivalents, 8–1
  - run-time options, 9–20 to 9–21
- UPDATE\_IF attribute, 8–7
- Uppercase letters, 5–7
- User buffers
  - address, 9–17
  - size, 9–18
- User identification codes
  - See UICs
- USER\_FILE\_OPEN attribute, 7–4
- USER\_INTERLOCK attribute, 7–4, 7–6

## V

---

- Variable-length records, 1–32
  - with D format, 2–10
  - with V (LSB) format, 2–9
  - with V (MSB) format, 2–9
- Variable with fixed-length control field
  - See VFC record format
- VAX BASIC
  - See BASIC
  - See BASIC USEROPEN routine

VAX COBOL  
  See COBOL  
VAX Fortran  
  See Fortran  
VAX Pascal  
  See Pascal  
Version numbers, 1–29  
VFC records, format, 1–2, 1–32, 2–11  
Virtual-block-position option, 4–36  
VIRTUAL option, 4–36  
VOL1 labels  
  See Volume labels  
VOL labels  
  See Volume labels  
VOLSET.SYS file, 1–10  
VOLUME attribute, 4–36  
Volume default extension quantity, 3–5, 3–8  
Volume identifier field, 1–27  
Volume labels  
  EOF (end-of-file) label, 1–22  
  EOV (end-of-volume) label, 1–22  
  VOL1 label, 1–24  
    accessibility field, 1–27  
    volume identifier field, 1–27  
  VOL label, 1–22  
Volume-number option, 4–36  
Volumes, 1–7  
  ANSI magnetic tape, 1–22  
  file configurations, 1–23, 1–24  
  label, 1–22  
  mounting  
    without HDR2 labels, 1–33  
  multidisk, 3–24  
  owner field, 1–27  
  positioning, 3–24  
Volume sets, 1–8  
  for improving performance, 3–10  
  list file, 1–10  
  loosely coupled, 1–10  
  to minimize disk head competition, 3–24

---

## W

Wait service, 8–5  
  asynchronous operations and, 8–19  
WAIT\_FOR\_RECORD attribute, 7–14  
Wildcard characters  
  See also File specifications  
  multiple file locations, 5–21  
  program preprocessing, 5–21 to 5–26  
Windows, 9–7 to 9–9  
  sizes, 10–27  
Working sets, 1–40  
\$WRITE service, use in calculating auto extend,  
  3–5

---

## X

XAB\$B\_AID field, 4–35  
XAB\$B\_ALN field, options, 4–35  
XAB\$B\_AOP field, options, 4–35  
XAB\$B\_BKZ field, 3–25, 4–32, 7–20, 7–21  
XAB\$L\_ALQ field, 4–35  
XAB\$L\_LOC field, 4–35, 4–36  
XAB\$W\_DEQ field, 4–36  
XAB\$W\_VOL field, 4–36  
XABDAT blocks  
  CDT field, 1–31  
  EDT field, 1–31  
XABs (extended attribute blocks), 1–36, 4–2  
  date and time fields, 4–32  
  key definition fields, 4–33  
  protection fields, 4–33

---

## Y

Year 2000 readiness, magnetic tape dating, 1–30

---

## Z

Zero creation date, 1–31

