

# English

ENGLISH

## ***Edition 1***

This publication could contain technical inaccuracies or typographical errors. Changes are made periodically to the information herein; these changes will be made in later editions. IBM may make improvements and/or changes in the product(s) and/or program(s) at any time.

It is possible that this publication may contain reference to, or information about, IBM products (machines and programs), programming, or services that are not announced in your country.

Requests for copies of this publication and for technical information about IBM products should be made to your IBM Authorized Dealer or IBM Retailer.

No part of this publication may be reproduced or distributed in any form or by any means without prior permission in writing from the International Business Machines Corporation.

© Copyright International Business Machines Corporation 1999.  
All rights reserved.

## ***Notices***

References in this publication to IBM products, programs, or services do not imply that IBM intends to make these available in all countries in which IBM operates. Any reference to an IBM product, program or service is not intended to state or imply that only IBM's product, program, or service may be used. Any functionally equivalent product, program, or service that does not infringe any of IBM's intellectual property rights or other legally

protectable rights may be used instead of the IBM product, program, or service. Evaluation and verification of operation in conjunction with other products, programs, or services, except those expressly designated by IBM, are the user's responsibility.

IBM may have patents or pending patent applications covering subject matter in this document. The furnishing of this document does not give you any license to these patents.

## ***Trademarks***

The following terms, used in this publication, are trademarks or service marks of the IBM Corporation in the United States or other countries:

**IBM HelpCenter**

**ENERGY STAR** is a U.S. registered mark.

# Contents

---

- Contents ..... 1**
- Setup ..... 2**
- User controls ..... 5**
- On-Screen-Display ..... 7**
- Further information ..... 14**
- Specifications ..... 16**
- Troubleshooting ..... 17**
- Compliances ..... A1**
- Warranty ..... A6**

# Setup

---

**Important:** Before connecting the monitor, turn off the computer and attached devices. Also ensure the power at the electrical outlet matches the power requirements of the monitor. Refer to the **Specifications** section on page 16 for more details.

## ***Attaching the Stand***

1. Place the monitor face down on a soft surface to prevent the screen being scratched.
2. Insert the hooks (1) into the matching slots on the underside of the monitor (2).
3. Slide the base towards the front of the monitor until the latch (3) clicks into the locked position.

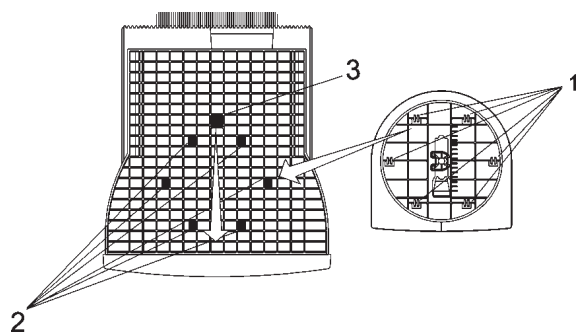

## Connecting your monitor

1. Connect the signal cable to the video port on the back of your computer (figure A). Your computer may have a video adapter card installed. In this case, attach the signal cable to the connector on the video adapter card (figure B).
2. Connect the power cord to the monitor first, then firmly insert the plug into a properly grounded electrical outlet.
3. Turn on the monitor, and then the computer.

If your monitor does not seem to be working correctly, refer to the **Troubleshooting** section on page 17 for help.

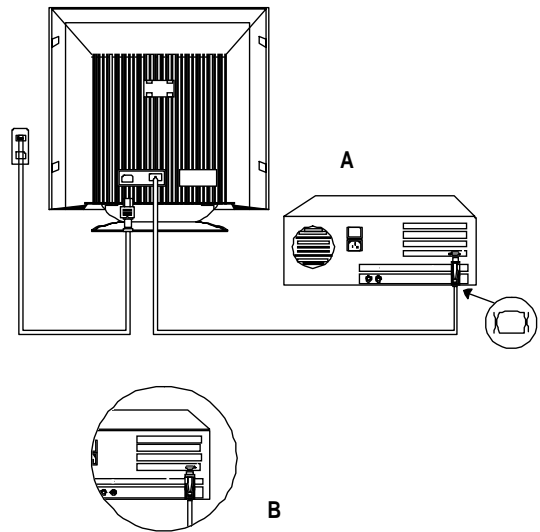

## ***Workplace preparation***

### ***Positioning the monitor***

Choose a suitable place to position the monitor where it is not near fluorescent desk lighting or any equipment that produces magnetic fields that could cause interference. Ensure that the furniture or equipment can support the weight of the monitor. Allow at least 2 inches (50mm) ventilation space around the monitor.

### ***Height***

The monitor should be positioned so that the top of the screen is slightly below your eye level when you sit at your workstation.

### ***Orientation***

Choose a position that gives the least reflection from lights and windows, usually at a right angle to any windows. The monitor should be positioned directly in front of you so that you do not have to twist your body. Tilt the monitor to a comfortable viewing angle.

## ***Working Practices***

### ***Rest***

Take regular breaks. Vary your posture, and stand up and stretch occasionally as prolonged use of computer workstations can be tiring.

### ***Back***

You should sit back in the chair and use the back rest.

### ***Hands***

Use a light touch on the keyboard, keeping your hands and fingers relaxed. Allow a space in front of the keyboard to rest your wrists when not typing. Consider using a wristpad.

### ***Eyesight***

Working with monitors, in common with any prolonged close work, can be visually demanding. Look away from the screen periodically and have your eyesight checked regularly.

### ***Screen settings***

Set the screen brightness and contrast to a comfortable level. You may have to adjust this as the lighting changes during the day. Many application programs let you select colour combinations which can help you to view in comfort.

# User controls

The image is already optimized for many display modes. However, the controls can be used to adjust the image to your liking.

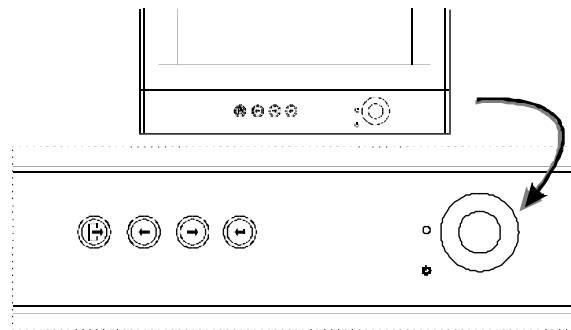



Icon	Control	Description
⏻	Power switch.	Switches the monitor on and off.
↵	OSD / Select	Activates the On-Screen-Display / select control icon.
→	Move right / down; Contrast adjustment selection	This control has two functions: 1) To move the highlighted icons to the right for selection. Also used to adjust image after control icon has been selected. 2) To adjust the image contrast.
←	Move left / up; Brightness adjustment selection	This control has two functions: 1) to move the highlighted icons to the left for selection. Also used to adjust image after control icon has been selected. 2) To adjust the image brightness.
⏏	Exit	Exit OSD control. Note: by selecting this button, the current set up will be saved.

### Contrast and Brightness

Contrast and Brightness can be adjusted as follows, without the need to display the OSD.

Select function and use " ← " " → " control to adjust: If adjustment is not made within 15 seconds, the current setup will be saved and the control screen will disappear automatically.



Icon	Content	Description
	Contrast	Adjusts contrast between foreground and background
	Brightness	Adjust background brightness

# On-Screen Display

## Activating the On-Screen Display

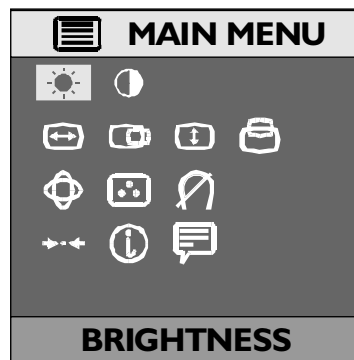





The monitor controls are accessed by pressing button  to enable OSD (On-Screen Display). The main menu will be displayed as follows.















Each Sub-Menu icon is selected by highlighting it via the "←" "→" control and pressing button (  ) to select. To exit the main or Sub-Menu, press the exit button (  ).

























Note: (1) To unlock / lock the adjustments made using the OSD, press and hold (  ) for 10 seconds.



(2) If no adjustment or selection of any OSD menu is made within 15 seconds, the current setup will be saved and the OSD will disappear automatically.



Brightness & Contrast			
Function	Effect of Control		Description
	←	→	
 BRIGHTNESS			Adjusts background brightness
 CONTRAST			Adjusts contrast between foreground and background



Screen Size & Position			
Function	Effect of Control		Description
	←	→	
 WIDTH			Adjusts image width
 H-POSITION			Moves image left or right
 HEIGHT			Adjusts image height
 V-POSITION			Moves image up or down



 Advanced

Function	Effect of Control		Description
	←	→	
 PINCUSHION			Adjusts the amount of curvature on the vertical edges in opposite directions.
 TRAPEZOID			Equalizes the length of the top and bottom edges.
 PARALLELOGRAM			Adjusts the tilt of the vertical edges.
 PINCUSHION BALANCE			Adjusts the amount of curvature on the vertical edges in the same direction.
 ROTATION			Tilts the image clockwise or counter-clockwise.
 H MOIRE			Horizontal moire cancellation function.
 V MOIRE			Vertical moire cancellation function.
 V LINEAR			Adjusts the linearity of vertical image.

 Color	
Function	Description
9300 K	Factory preset color temperature of 9300 K
6500 K	Factory preset color temperature of 6500 K
 R G B	User set 1 for color temperature. Select R, G, B for adjustment using the user controls. Adjusts red intensity. Adjusts green intensity. Adjusts blue intensity.
 R G B	User set 2 for color temperature. Select R, G or B for adjustment using the user controls. Adjust red intensity. Adjusts green intensity. Adjuste blue intensity.

Degauss & Reset	
Function	Description
 DEGAUSS	<p>Demagnetizes the monitor.            Discoloration of the image can be caused by gradual magnetization of the monitor components. This is particularly likely to occur when the monitor is moved or rotated. The monitor may "buzz" momentarily when this user control is selected and the image will change color and wobble for a few seconds. These effects are normal. Do not use this feature more than once in any 30 minute period.</p> <p>YES: The screen will degauss.            NO: Escape the DEGAUSS function.</p>
 RESET	<p>Recall all settings back to the factory defaults.</p> <p>YES: Confirm the RESET function.            NO: Escape the RESET function.</p>

 Information	
Function	Description
 USER / PRESET MODE	The screen displays the details of the user defined display modes. Press "←" or "→" to switch between the Preset or User Mode screens. The details displayed are addressability, refresh rate, horizontal frequency, sync polarity and the current mode of operation.

 Language	
Function	Description
 LANGUAGE	Select the OSD language. The available languages are English (default), German, Spanish, French and Italian.

# Further information

---

## *Display modes*

The display mode the monitor uses is controlled by the computer. Therefore you should refer to your computer documentation for details on how to change display modes.

The image size, position and shape may change when the display mode changes. This is normal and the image can be readjusted using the monitor controls.

To ensure flicker-free operation, select the highest **(non-interlaced)** refresh rate both the computer and the monitor can support, (generally 75 Hz or higher), for the addressability that your application requires.

For the display modes listed in table 1, the screen image has been optimized during manufacture.

Addressability	Refresh Rate	Horizontal Frequency
640 x 480	60 Hz	31.5 kHz
720 x 400	70 Hz	31.5 kHz
640 x 480	75 Hz	37.5 kHz
720 x 400	85 Hz	38.0 kHz
960 x 529 *	75 Hz	41.8 kHz
640 x 480	85 Hz	43.3 kHz
800 x 600	75 Hz	46.9 kHz
800 x 600	85 Hz	53.7 kHz
1024 x 768	75 Hz	60.0 kHz
1024 x 768	85 Hz	68.7 kHz

Table 1. Factory Preset Mode

\* MFI2 mode

## Power Management

To benefit from power management, the monitor must be used in conjunction with a computer that implements the Video Electronics Standards Association (VESA) Display Power Management Signalling (DPMS) Standard.

The power management feature is invoked when the computer recognizes that you have not used your mouse or keyboard for a user-definable period of time. There are several states as described in the table below.

State	Power indicator	Screen	Restoring Operation	Compliance
ON	Steady green	Normal		
VESA Standby	Flashing green 0.5 sec interval	Blank	Press a key or move the mouse *	
VESA Suspend	Flashing green 1.0 sec interval	Blank	Press a key or move the mouse *	ENERGY STAR
VESA Off	Flashing green 2.0 sec interval	Blank	Press a key or move the mouse *	ENERGY STAR & NUTEK
Out of Frequency Range	Flashing green 0.3 sec interval	Blank	Input with normal PC signal (H/V sync.), it will restart automatically	

\* There may be a slight delay before the picture returns

As an ENERGY STAR (R) Partner, IBM has determined that this product meets the ENERGY STAR guidelines for energy efficiency. IBM recommends that you switch off your monitor at the end of each working day, or whenever you expect to leave it unused for long periods during the day.

# Specifications

The E74 (M/T 6564-x2x) color monitor uses a 17 inch FST CRT with a viewable image size of 15.9 inches (403 mm).

Dimensions	Width:	16.3 inch (414 mm)
	Depth:	17.4 inch (443 mm)
	Height:	17.9 inch (455 mm)
Weight		41.8 lb (16 Kg)
Tilt Swivel	Forward tilt:	4.5
	Backward tilt:	15
	Swivel:	+ 90 / -230
Image	Maximum Height:	9.5 inch (242 mm)
	Maximum Width:	12.7 inch (323 mm)
	Dot Pitch:	0.27 mm
Power Input	Supply Voltage:	100-240 Vac 50/60 Hz
	Max Supply Current:	1.8A at 100 Vac
Video input	Input Signal:	Analogue Direct Drive, 75 ohm 0-0.7v
	H. Addressability:	1280 pels (max.)
	V. Addressability:	1024 lines (max.)
	Clock Rate:	110 Mpels/sec

Communication	VESA DDC	1/2 B
Synchronization Range	Horiz. Frequency:	30 kHz - 69 kHz
	Vert. Frequency:	50 Hz - 120 Hz
Power Consumption (Typical)	Normal Operation:	< 110 W
	VESA Standby:	< 15 W
	VESA Suspend:	< 15 W
	VESA Off:	< 8 W
Environment	Operating Temperature:	
	Storage Temperature:	-25 to 60 C
	Shipping Temperature:	-20 to 60 C
	Operating Humidity:	10 to 80 %
	Storage Humidity:	10 to 90 %
	Shipping Humidity:	10 to 90 %

# Troubleshooting

If you have a problem setting up or using your monitor, you may be able to solve it yourself. Before calling your retailer or IBM you should try the suggested actions that are appropriate to your problem.

Problem	Possible Cause	Suggested Action	Reference
Screen is blank and power indicator is off.	No power to monitor.	Ensure the electrical outlet and the monitor are both switched on. Check power cord is firmly plugged into the monitor and the electrical outlet. If the power cord plug has a removable fuse, replace it. Try another power cord. Try another electrical outlet.	"Setup" section starting on page 2
Screen is blank and power indicator is steady green.	Brightness and Contrast may be too low.	Adjust brightness and contrast.	"User controls" section starting on page 5
"SIGNAL OUT OF RANGE" message is displayed.	Display mode of the computer is outside the range of the monitor.	Reconfigure the computer to use a supported display mode.	"Further Information" section starting on page 14
"CHECK SIGNAL CABLE" message is displayed.	Video cable connection.	Check the signal cable is firmly connected to the computer. Check no pins are bent in the signal cable connector.	

Problem	Possible Cause	Suggested Action	Reference
Screen is blank and power indicator is flashing green 0.5/1.0/2.0 sec interval.	The monitor is in Power Management Standby / Suspend or Off state.	Press any key on the keyboard or move the mouse to restore operation.	
	No video signal from the computer.	Check the computer is powered on. Check the signal cable is firmly connected to the computer. Check no pins are bent in the signal cable connector.	
Image appears to be flickering.	The monitor is operating in an interlaced or low refresh rate display mode.	Reconfigure the computer to use a non-interlaced display mode with a refresh rate of at least 75 Hz.	"Further information" section starting on page 14
	The monitor may be affected by interference from nearby equipment.	Move fluorescent desk lighting or any equipment that produces magnetic fields further away from the monitor.	
		If another monitor is close by, a separation distance of at least 12 inches (300mm) is recommended.	

Problem	Possible Cause	Suggested Action	Reference
Image appears to be discolored.	The monitor may be affected by interference from nearby equipment.	Move any equipment that produces magnetic fields (e.g. sub woofer loud speakers) further away from the monitor. If another monitor is close by, a separation distance of at least 12 inches (300mm) is recommended.	
	Magnetization of monitor components has built up.	Degauss the monitor using OSD manual demagnetize function. This function can only be used once in a 30 minute period.	

### ***Further help***

If you are unable to correct the problem yourself, you may seek further help as follows:

Call IBM HELPCENTER.

In the US call 1-800-722-2227

In Canada call 1-800-565-3344

In other countries, contact your dealer, retailer, or other IBM authorized servicer.

Before calling, please have available as much of the following information as possible:

1. Type, model and serial number from the label on the back of your monitor.
2. Purchase receipt.
3. Description of problem.
4. Computer type and model.
5. System configuration (hardware fitted etc.).
6. System BIOS version number.
7. Operating System and version number.
8. Display driver version number.

If possible, stay by your computer system. Your technical support representative might want to go through the problem with you during the call.