

TOSHIBA

Color Television

OWNER'S MANUAL

CF19E22



SET UP

BASIC OPERATION

ADVANCED
OPERATION

EQUIPMENT
CONNECTIONS

REFERENCE
SECTION

Dear Customer

Congratulations! You have purchased one of the finest Color TV's on the market!

This manual will help you use the many exciting and useful features to make your TV viewing more enjoyable than ever before.

Before operating your TV set, please read all these safety and operating instructions completely and then retain for future reference.

Customer's Record

You will find the model number and serial number on the back of your TV set.

Record these numbers in the spaces provided below. Refer to them whenever you call upon your TOSHIBA dealer regarding this product.

Model Number _____

Serial Number _____

Safety Precautions

WARNING:

TO REDUCE THE RISK OF FIRE OR ELECTRIC SHOCK, DO NOT EXPOSE THIS APPLIANCE TO RAIN OR MOISTURE.

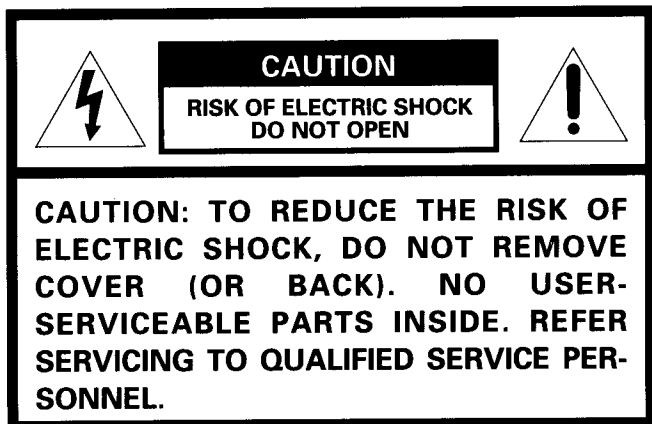

The lightning symbol in the triangle tells you that the voltage inside this product may be strong enough to cause an electric shock. DO NOT TRY TO SERVICE THIS PRODUCT YOURSELF.



The exclamation point in the triangle tells you that important operating and maintenance instructions follow this symbol.

CAUTIONS:

TO PREVENT ELECTRIC SHOCK, DO NOT USE THIS POLARIZED PLUG WITH AN EXTENSION CORD RECEPTACLE OR OTHER OUTLET UNLESS THE PRONGS CAN BE FULLY INSERTED INTO THE OUTLET TO PREVENT ANY EXPOSURE OF THE PRONGS ON THE POLARIZED PLUG.

Avoid displaying stationary images on your TV screen for extended periods of time. Stationary patterns generated by computer displays, video games, stock market reports, etc. can become permanently engrained on the picture tube. This damage is not protected by your warranty as it is the result of misuse. Should you wish to use your TOSHIBA Television to display still images, it is always advisable to reduce brightness and contrast settings. Never leave a video game or computer display unattended.

NOTE TO CATV SYSTEM INSTALLER IN THE USA:

This reminder is provided to call the CATV system installer's attention to Article 820-40 of the NEC that provides guidelines for proper grounding and, in particular, specifies that the cable ground shall be connected to the grounding system of the building, as close to the point of cable entry as practical.

Installing Your TV Set

WARNING

TO AVOID PERSONAL INJURY

- Do not place the TV on an uneven floor or on unstable stand.
- Do not stand or climb on the TV.
- Do not put a VCR or any heavy object on top of the TV.

Do not

- Place your TV set in a room where direct lighting strikes the screen.
- Place your TV set too close to a wall, in a confined area or in a very warm location.
- Change the plug's safety prong.

Do

- Use soft and indirect lighting.
- Sit at least 6 feet away from the set.
- Provide normal air circulation for reliable long life.
- Plug into an electrical outlet with standard house power (120 volt AC, 60 Hz).

CAUTION:

As a safety feature, the plug has one prong wider than the other. It will fit only one way into a standard electrical outlet. If the plug will not fit into the outlet, try turning it around. If the plug will not fit either way, the outlet is probably old and non-standard. You will need to have a new outlet installed by an electrician. DO NOT CHANGE THE SAFETY FEATURE OF THE PLUG.

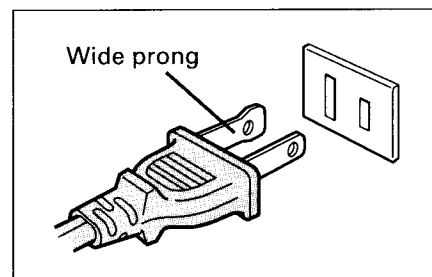

Antenna/Cable TV General Information

You can use either an indoor or outdoor antenna to receive VHF and/or UHF channels.

Channels 2–13 are VHF channels, and channels 14–69 are UHF channels.

We recommend using an outdoor antenna for better picture quality.

You can receive Cable TV by connecting a cable supplied by your local cable company.

Cable TV delivers both VHF and UHF channels and other channels not available from your antenna.

Types of antenna cables

Shown below are two basic types of antenna cables. Signals from a home antenna may be conducted through either type. Cable TV signals will always be conducted through 75 ohm coaxial cable.

1. A 75 ohm system is generally a round cable with F-type connectors that can easily be attached to terminal without tools.

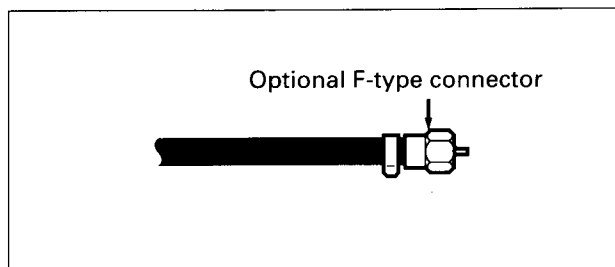

2. A 300 ohm system is a flat "twin-lead" cable that can be attached to a terminal through an optional antenna adapter.

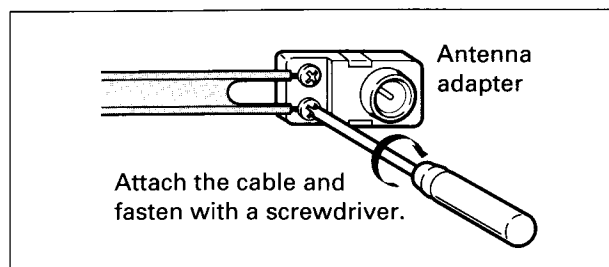

Antenna/Cable TV Connection

Connecting an antenna or Cable without a decoder box

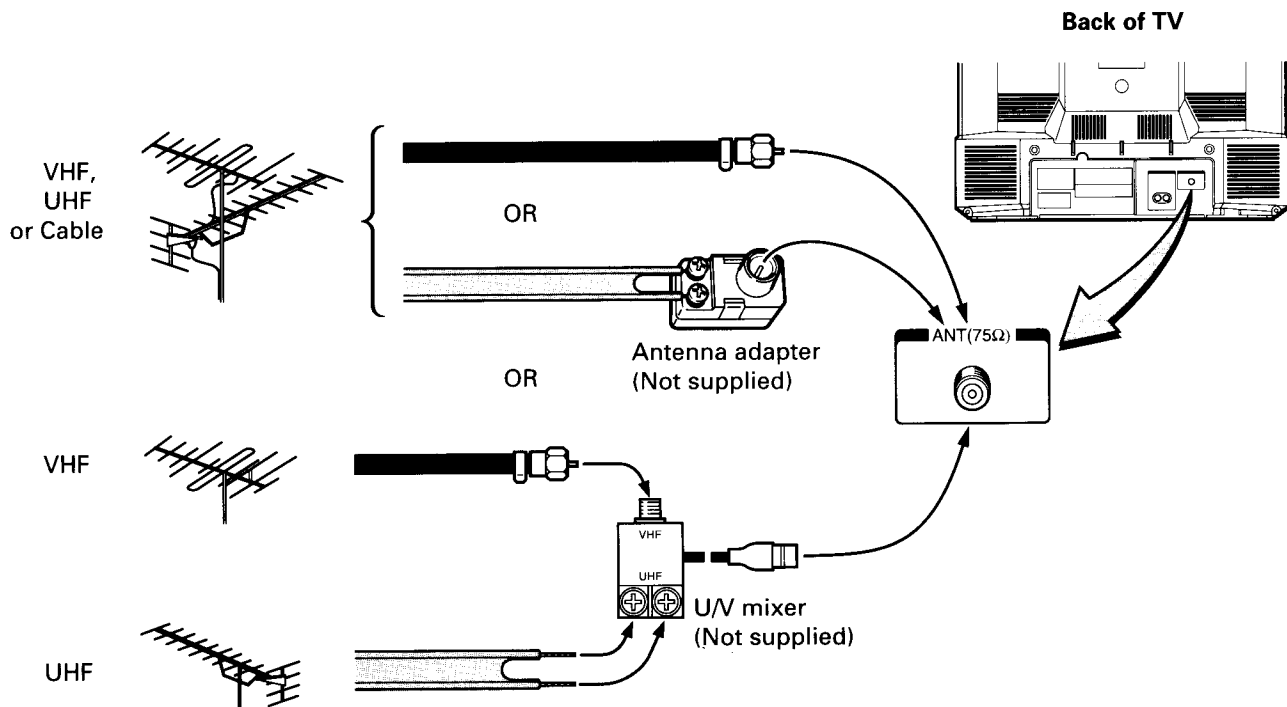

Connecting a Cable with a decoder box

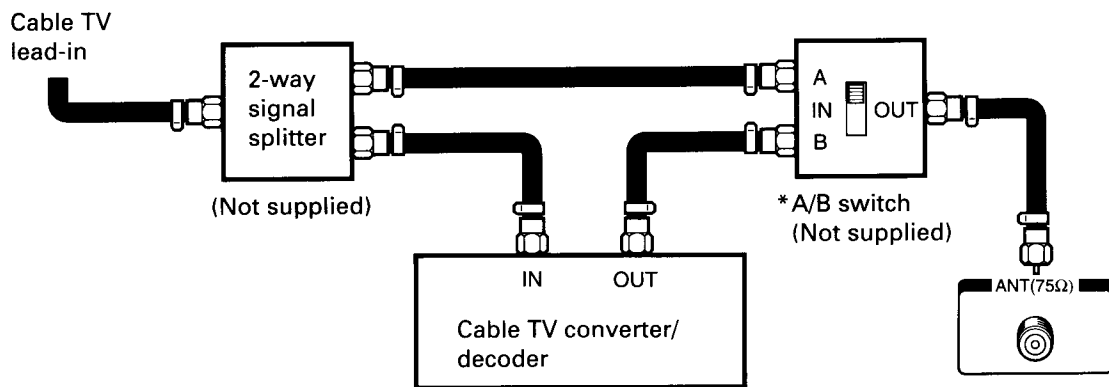

Notes:

- * "A" position on the A/B switch allows you to select unscrambled channels using the TV's channel keys.
- "B" position allows you to select scrambled channels via the converter/decoder box using the converter's channel keys. Place your TV on channel 3 or 4 to match the converter's output channel.
- If you use a VCR, connect its antenna in/out between the decoder box and A/B switch.

Operation and Controls (TV Set)

For specific use of each control, consult the corresponding page numbers in brackets.

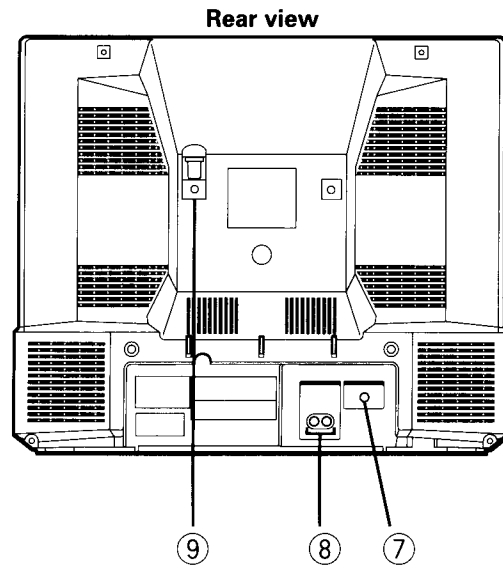
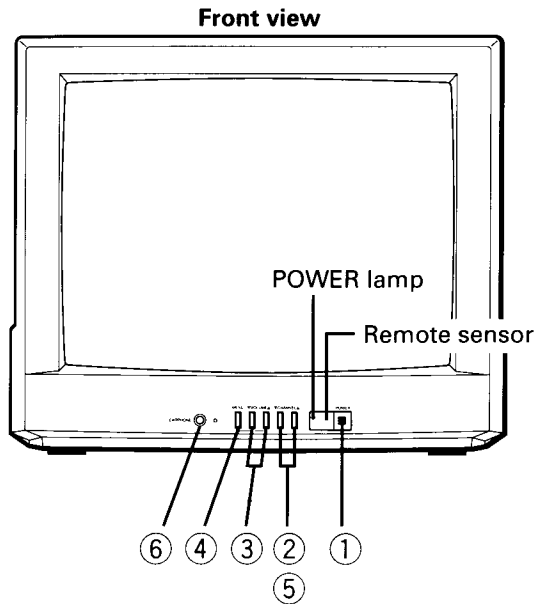

- ① POWER button
Press to turn on the TV.
Press again to turn off the TV.
- ② CHANNEL ▼/▲ buttons
Press ▲ to select next higher channel.
Press ▼ to select next lower channel.
- ③ VOLUME ▼/▲ buttons (Dual function with ⑤)
Press ▲ to increase the volume.
Press ▼ to decrease the volume.
- ④ MENU button
Each time you press **MENU**, each item will be selected in order, then press - or +.

- ⑤ -/+ buttons
Use these -/+ after you have selected the item you want to adjust by pressing MENU.
- ⑥ EARPHONE jack
- ⑦ Antenna/Cable terminal [4]
- ⑧ VIDEO/AUDIO INPUT jacks [13]
- ⑨ Indoor antenna socket

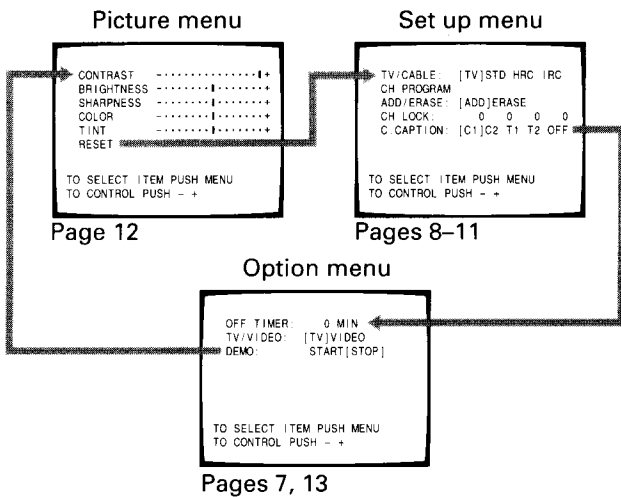

Auto-Power-Off

If a vacant channel is tuned in or a TV broadcast has finished for the day, the TV automatically turns off after about 15 minutes. This feature does not operate in the VIDEO mode.

Last Mode Memory

If the power is cut off while you are watching the TV and then later restored, the TV will turn back on automatically by the **Last Mode Memory** feature. To ensure that the power does not turn on, when you are away from home for a long time, unplug the power cord from the wall outlet.

SET UP

BASIC OPERATION

Antenna/Cable TV Connection
Operation and Controls (TV Set)

Operation and Controls (Remote Control)

This Remote Control allows you to control the functions of your TV set from 16 feet (5m) away. The "*" marked function buttons do not have duplicate locations on your TV set. They can be controlled only by the Remote Control. For specific use of each control, consult the corresponding page numbers in brackets.

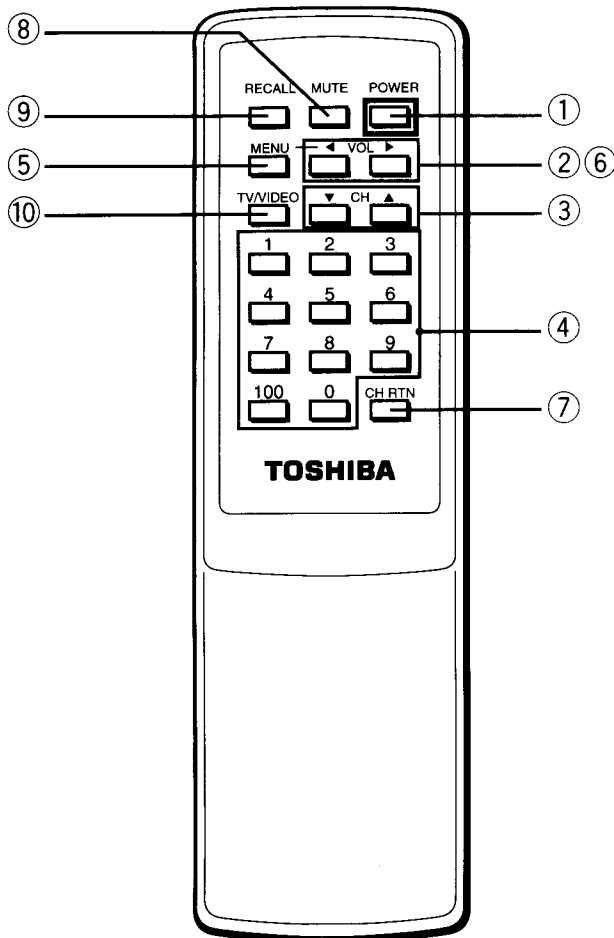

- ① **POWER** button
Press to turn on the TV.
Press again to turn off the TV.
- ② **VOLUME** ◀/▶ buttons (Dual function with ⑤)
Press ▶ to increase the volume.
Press ◀ to decrease the volume.
- ③ **CHANNEL** ▼/▲ buttons
Press ▲ to select next higher channel.
Press ▼ to select next lower channel.
- ④ **Channel Number** buttons*
To select channel 4, press "4" (or press "0", "4").
To select channel 38, press "3", "8".
To select channel 125, press "100", "2", "5" in sequence.
- ⑤ **MENU** button [5]
- ⑥ **-/+** buttons [5]
- ⑦ **CH RTN** (Channel Return) button* [7]
- ⑧ **MUTE** button* [7]
- ⑨ **RECALL** button* [7]
- ⑩ **TV/VIDEO** button* [13]

Installing and replacing batteries

- 1 Place the Remote Control with the face down. Press down on the ridged area of the battery cover and slide it off.

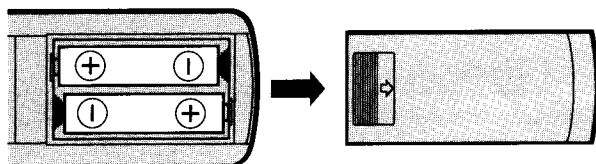

- 2 Place the two "AA" size batteries, matching the + and - signs on each battery to the + and - signs of the battery compartment
- 3 Replace the battery cover until the lock snaps.

CAUTIONS:

- Do not throw your batteries into a fire. Dispose of your batteries in a designated disposal area.
- Do not combine used old batteries with new ones.
- Do not mix battery types.

Notes:

- If your Remote Control does not always adjust the set as you wish, you probably need to replace the batteries. The life expectancy of the battery is about one year.
- Remove dead batteries immediately to prevent battery acid from leaking into the battery compartment.
- If you do not intend to use the Remote Control for a long period, remove the batteries.

Convenient Remote Functions

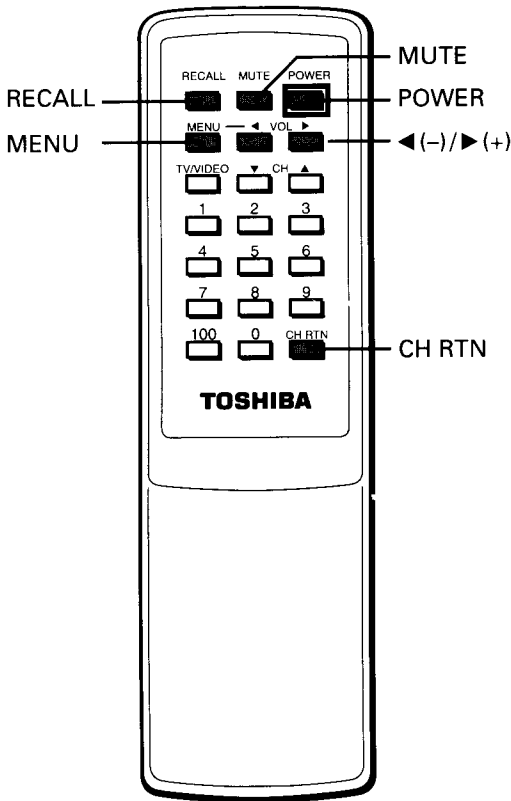

To display on-screen information

Press **RECALL** to display the following on-screen information.

- Channel number
- VIDEO mode selected
- Closed Caption or Text program status

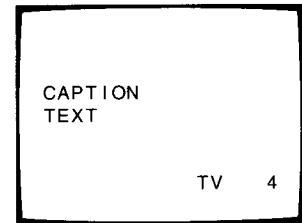

Or to erase the on-screen menu display instantly, press **RECALL**.

To mute the sound

Press **MUTE** to mute the sound. The word "MUTE" will be displayed on the screen as shown. This is useful during telephone calls or other interruptions.

To restore the sound, press **MUTE** again.



To change quickly between two channels

Press **CH RTN** to return to the last channel viewed.

This is useful should you want to view two channels. This allows you to view two programs without entering an actual channel number each time.

To operate this function

- 1 Select the first channel you want to view.
- 2 Select the other channel with the Channel Number buttons.
- 3 Press **CH RTN**.
The previous channel will return.

Each time you press **CH RTN**, the TV will switch back and forth between the two channels.

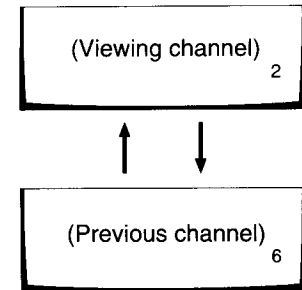

Notes on the OFF-timer

- To cancel the OFF-timer, press **POWER**.
To turn the TV on again, press **POWER**.
- The OFF-timer setting can also be performed using the **MENU** and **-/+** buttons on the TV.

To set the OFF-timer

With the OFF timer, you can set the TV to turn off automatically after a predetermined period of time (up to 3 hours, in 10 minutes units).

- 1 Press **MENU** repeatedly until "OFF TIMER" in the Option menu is displayed in magenta.
- 2 Press **-** or **+** to enter the length of time you want the TV to stay on. If you press The **+** button, the time display will increase 10 minutes or the **-** button the time display will decrease 10 minutes.

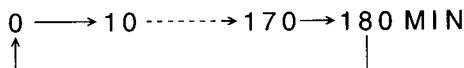
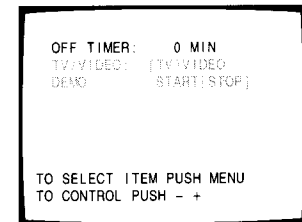

Programming Channel Memory

The channel memory is the list of TV channel numbers your TV will stop on when you press the CHANNEL ▲ or ▼ button. **First, use the TV/CABLE and CH PROGRAM functions to preset all active channels in your area.** If necessary, arrange the preset channels with the ADD/ERASE functions so that you can tune into only desired channels.

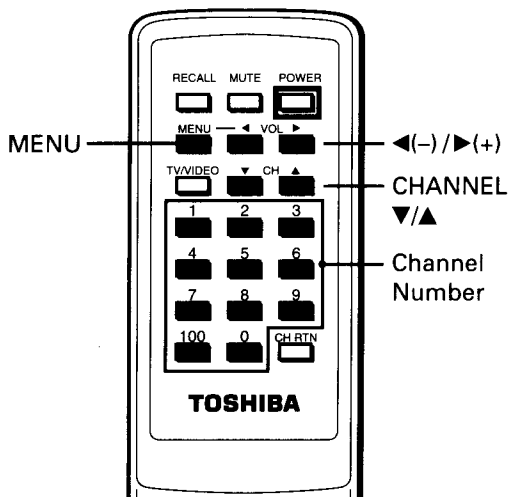
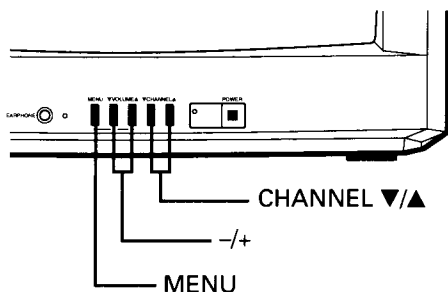

TV/CABLE function

- 1 Press **POWER** to turn on the TV.
- 2 Press **MENU** repeatedly until "TV/CABLE" in the Set up menu is displayed in magenta.
- 3 Press **-** or **+** until the mode that corresponds to your TV signal system is displayed in magenta. Each time you press the button, the TV*, STD CABLE*, HRC CABLE* or IRC CABLE* mode will be selected in order.

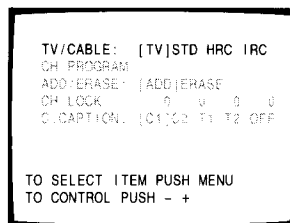
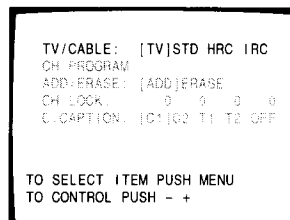

CH PROGRAM function

- 1 Press **MENU** repeatedly until "CH PROGRAM" in the Set up menu is displayed in magenta.
- 2 Press **-** or **+** to start channel programming. The TV will automatically cycle through all the TV or CABLE channels depending on the mode selected, and store active channels in the channel memory.
- 3 When channel programming is complete, you will see the message at the right.
- 4 Press **CHANNEL ▲** or **▼** to make sure the channel programming has been done properly.

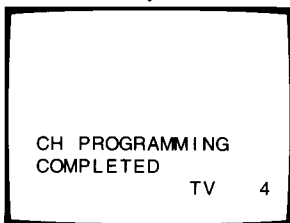
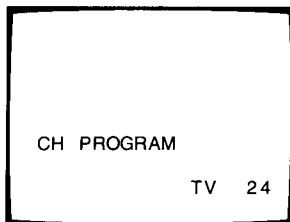
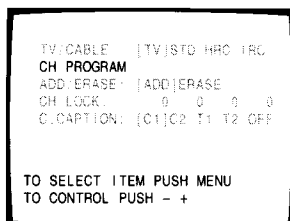

* This TV receives the following TV signals:

1. **TV:** TV broadcasts signals. (VHF channels 2 through 13 and UHF channels 14 through 69)
2. **STD CABLE:** Standard cable TV signals.
3. **HRC CABLE:** Harmonic Related Carrier cable TV signals.
4. **IRC CABLE:** Incremental Related Carrier cable TV signals.

If you are not sure what CABLE system they are using, consult your local CABLE company.

ADD/ERASE function

After performing the CH PROGRAM function, you can add or erase specific channels.

- 1 Select the channel you want to erase using the **CHANNEL ▲** or **▼** button, or select the channel you want to add using the **Channel Number** buttons.

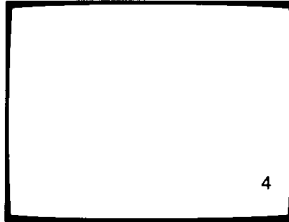

- 2 Press **MENU** repeatedly until "ADD/ERASE" in the Set up menu is displayed in magenta.

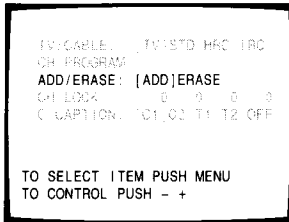

- 3 Press **-** or **+**:
 - To erase the channel**

Press the button until "ERASE" is displayed in magenta indicating that the channel has been erased from the memory.

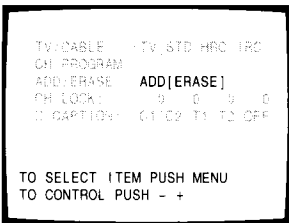

- To add the channel**

Press the button until "ADD" is displayed in magenta indicating that the channel has been memorized.

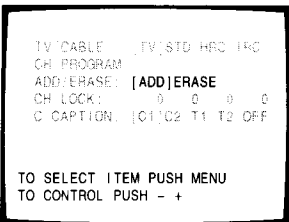

- 4 Repeat steps 1 to 3 for other channels.

You have now completed the channel programming.

Note: The **-/+** buttons also function as the **VOLUME ▼ (◀) / ▲ (▶)** buttons when no menu display is on the screen.

CABLE channel reference chart

Number on this TV	Corresponding CABLE channel	Number on this TV	Corresponding CABLE channel
1	A-8	67	67
5	5 (A-7)	68	68
6	6 (A-6)	69	69
14	A	⋮	⋮
15	B	92	92
16	C	93	93
⋮	⋮	94	94
34	U	95	A-5
35	V	96	A-4
36	W	97	A-3
37	AA	98	A-2
38	BB	99	A-1
⋮	⋮	100	100
60	XX	101	101
61	YY	102	102
62	ZZ	⋮	⋮
63	AAA	123	123
64	BBB	124	124
65	65	125	125
66	66		

The above chart is typical of many cable system channel allocations. If in doubt, consult your cable company.

Locking Channels

This feature allows you to program the TV so that any specific channel cannot be viewed without the use of the Channel Number buttons on the Remote Control.

This TV has 4 memory spaces total for the TV and Cable modes, 4 spaces for TV and 4 spaces for Cable.

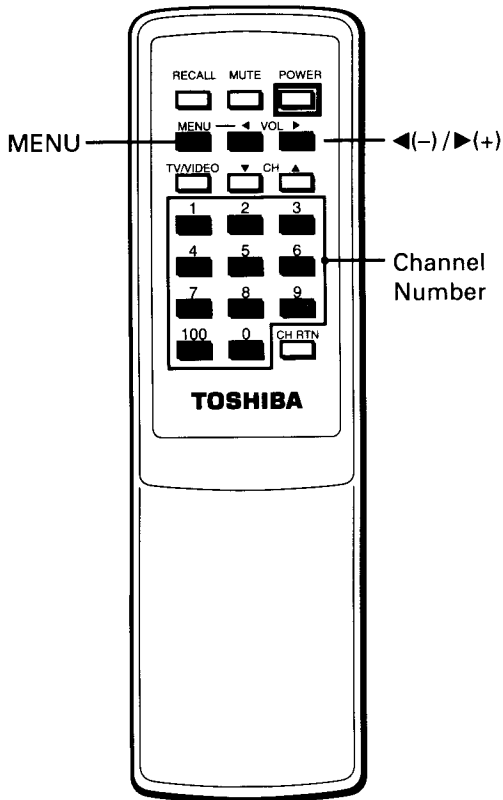
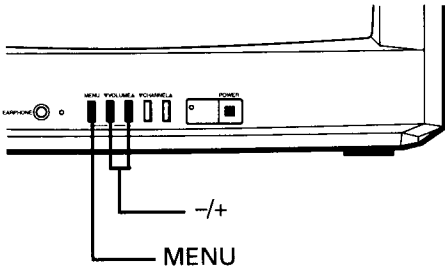

To lock out channels

- 1 Select a channel you want to lock out. (Example: channel 4)
- 2 Press **MENU** repeatedly until "CH LOCK" in the Set up menu is displayed in magenta.

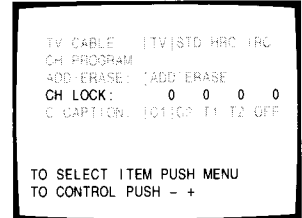

- 3 Press - or + until the channel number you selected "4" replaces the zero "0" in the channel lock program display.

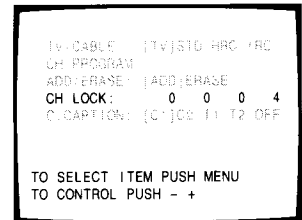

- 4 Repeat steps 1 to 3 for other channels.
- 5 Select another channel, or turn off the TV if desired.

If you want to know the channels you have locked out
Press MENU to display the Set up menu.

To restore channels

- 1 Select the channel you want to restore to normal viewing by pressing the **Channel Number** buttons. (Example: channel 7)
- 2 Press **MENU** repeatedly until "CH LOCK" is displayed in magenta.

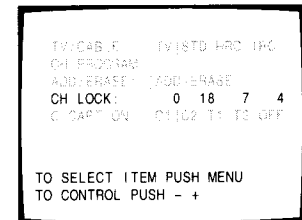

- 3 Press - or + until the zero "0" replaces the channel number display "7" you want to restore in the channel lock program display.

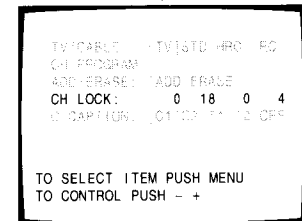

- 4 Repeat steps 1 to 3 for other channels.

Operating Closed Captioning Feature

CAPTION mode example display (C1, C2)

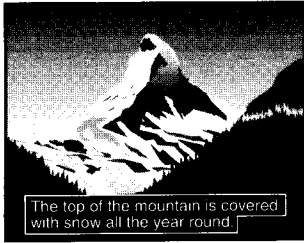

TEXT mode example display (T1, T2)

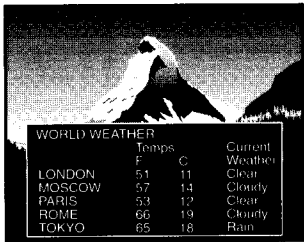

CAPTIONS

Closed captioning provides an on-screen display of the dialogue, narration, and/or sound effects of a TV program. Captions will appear at either the top or bottom of the screen while a captioned broadcast is shown. Captioning is especially helpful for hearing impaired individuals.

TEXT

Text is information that is presented on a portion of the TV screen. It is usually not related to the program. For example, it could be a listing of the closed-captioned programs, news, weather information or stock market reports.

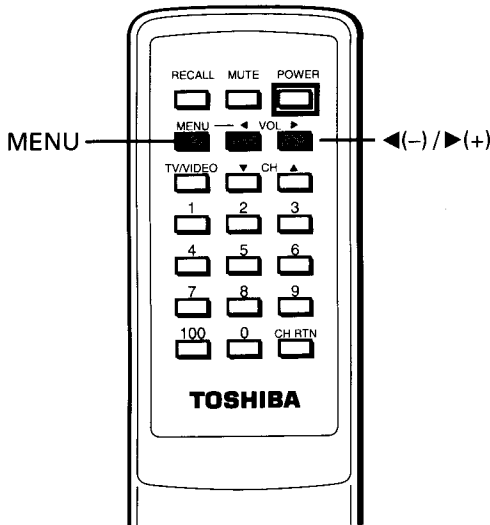
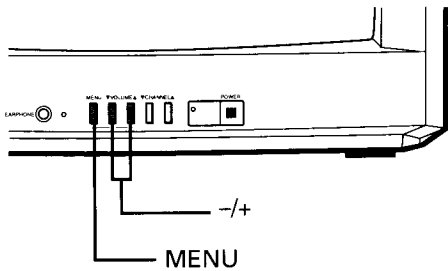

To view captions or text

- 1 Select the desired program.
- 2 Press **RECALL** to check if the program is being captioned. If it is, the word "CAPTION" or "TEXT" is displayed on the screen. The captioned programs are usually notated on your local TV listings by its service marks such as "CC".
- 3 Press **MENU** repeatedly until "C. CAPTION" in the Set up menu is displayed in magenta.
- 4 Press - or + until "C1", "C2", "T1" or "T2" is displayed in magenta. The C2 mode may be utilized for alternate languages if they are being transmitted. Usable selections are displayed in yellow.

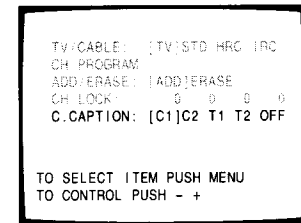
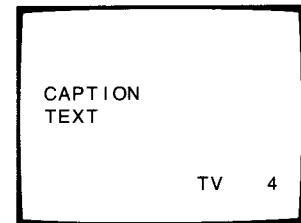

To deactivate this feature

Select "OFF" in the C. CAPTION mode display.

Notes:

- A closed captioned signal may not be decoded in the following situations.
 - When a video tape has been dubbed.
 - When the signal reception is weak.
 - When the signal has been changed or altered.
- If you select a Caption format channel and the "T1 or T2" mode, the TEXT screen will always be displayed. However, if the TEXT character signal is not transmitted, the characters are not displayed.

Adjusting the Picture

You can adjust the picture quality (CONTRAST, BRIGHTNESS, SHARPNESS, COLOR and TINT) to suit your personal preference.

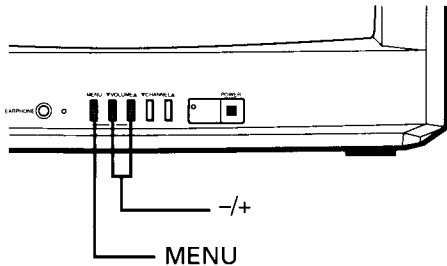

To adjust the picture quality

- 1 Press **MENU** repeatedly until the selection in the Picture menu is displayed in magenta.

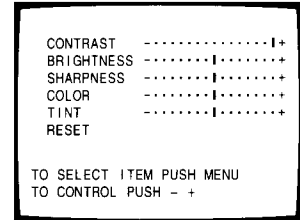

- 2 Press **-** or **+** to adjust the level.

Example: CONTRAST adjustment mode display

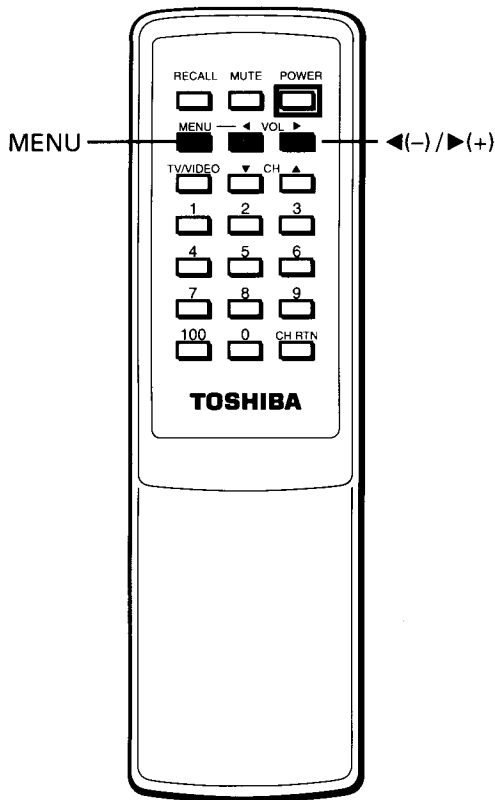
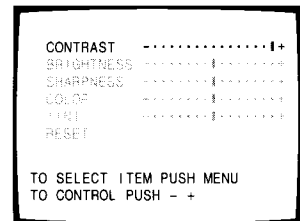

Selection	Pressing	
	-	+
CONTRAST	lower	higher
BRIGHTNESS	darker	lighter
SHARPNESS	softer	sharper
COLOR	paler	deeper
TINT	reddish	greenish

To reset the PICTURE adjustment to the factory-preset level
 (maximum CONTRAST and all other adjustments centered)

- 1 Press **MENU** repeatedly until "RESET" in the Picture menu is displayed in magenta.

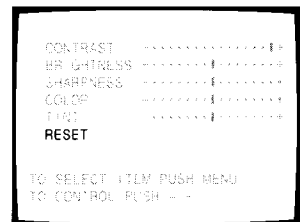

- 2 Press **-** or **+**.

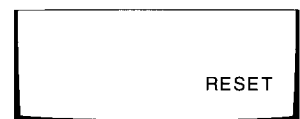

Connecting a VCR

Connect VIDEO/AUDIO IN jacks to the video/audio output jacks of a VCR, Laserdisc Player, Camcorder, etc. for playback of video material.

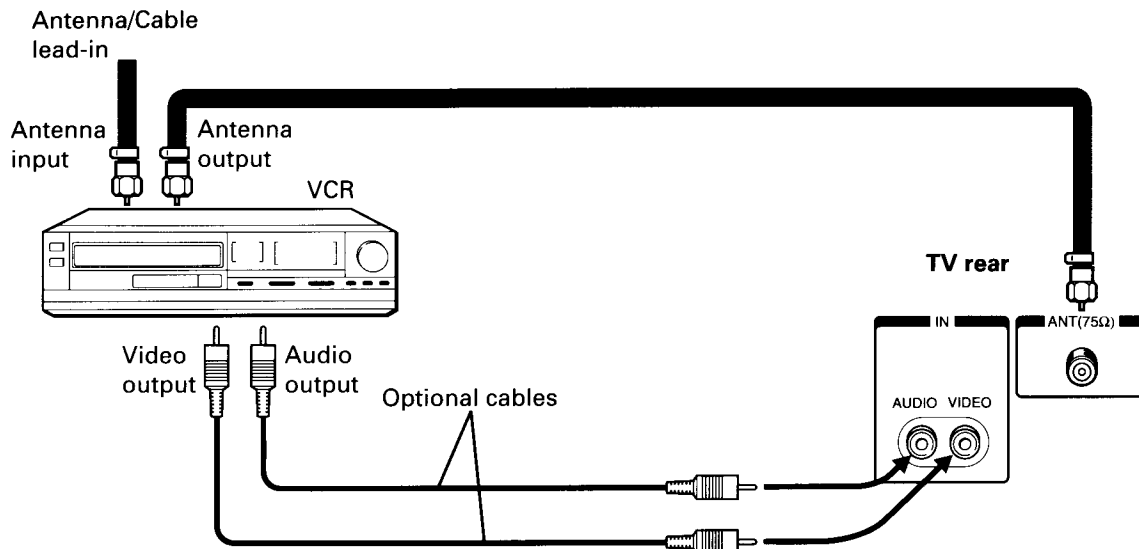

Adjusting the Picture
Connecting a VCR / Option Menu

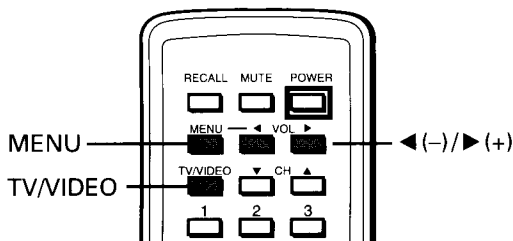

To select video input source

To operate your TV and video equipment properly, refer to the instructions furnished with the video equipment.

- 1 Press **TV/VIDEO** on the Remote Control until "VIDEO" is displayed on the screen in magenta.



- 2 Operate your VCR normally.

ADVANCED
OPERATION

EQUIPMENT
CONNECTIONS

Option Menu

OFF-TIMER — You can set the TV to turn off automatically after a predetermined period of time. See page 7 for details.

TV/VIDEO — You can also select VIDEO source using this menu. Select "VIDEO" using **MENU** and **-/+** buttons.

DEMO — When this function is activated, your TV will automatically display a variety of its on-screen menus and special features. This function is provided for demonstration purpose only. Select "START" using **MENU** and **-/+** buttons.

To stop the demonstration
Press **RECALL**, or select "STOP".

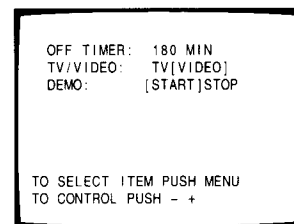

Before Calling Service Personnel

Before calling service personnel, please check the following chart for a possible cause of the problem you are experiencing. A minor adjustment on your part may eliminate the problem and restore your TV reception.

Symptoms	Check	Adjustments
● No picture, no sound	<ul style="list-style-type: none"> ● Be sure power cord is plugged in. ● May be station trouble. ● Check antenna connections. ● Check antenna for broken wires. 	<ul style="list-style-type: none"> ● Press POWER button. ● Try another channel.
● No sound, picture OK	<ul style="list-style-type: none"> ● May be station trouble. 	<ul style="list-style-type: none"> ● Try another channel. ● Adjust VOLUME.
● Poor sound, picture OK	<ul style="list-style-type: none"> ● May be station trouble. ● Check antenna connections. ● May be local interference from appliance. 	<ul style="list-style-type: none"> ● Try another channel. ● Adjust VOLUME. ● Re-orient antenna.
<ul style="list-style-type: none"> ● Poor picture, sound OK ● Snowy picture ● Lines in picture ● Distorted picture ● Weak picture 	<ul style="list-style-type: none"> ● May be local interference from appliance. ● Check antenna connections. ● Check antenna for broken wires. ● May be station trouble. 	<ul style="list-style-type: none"> ● Try another channel. ● Adjust BRIGHTNESS. ● Adjust CONTRAST. ● Adjust SHARPNESS. ● Re-orient antenna.
● Poor reception of broadcast channels	<ul style="list-style-type: none"> ● Check antenna connections. ● Check antenna for broken wires. ● If VCR is connected, check TV/VCR switch on the VCR. 	<ul style="list-style-type: none"> ● Try another channel. ● Re-orient antenna.
● No UHF, VHF OK	<ul style="list-style-type: none"> ● Be sure TV/CABLE function (page 8) is in "TV" mode. 	
● Unable to select a certain channel with CHANNEL ▲/▼ buttons	<ul style="list-style-type: none"> ● That channel may be locked out with CH LOCK function (page 10), or erased with the ADD/ERASE function (page 9). 	
● Multiple images (ghosts)	<ul style="list-style-type: none"> ● May be station trouble. ● Check antenna connections. 	<ul style="list-style-type: none"> ● Try another channel. ● Re-orient antenna.
● Poor color or No color	<ul style="list-style-type: none"> ● May be station trouble. ● Check antenna connections. ● Check antenna for broken wires. ● May be local interference from appliance. ● Check if station is broadcasting in color. ● If you change the direction of the TV while the TV is activated, the picture may suffer from color shading. If so, turn off the TV and allow for about 30 minutes to cool, then turn on the TV again. The picture should improve. 	<ul style="list-style-type: none"> ● Try another channel. ● Re-orient antenna. ● Adjust TINT. ● Adjust COLOR.
● Remote Control does not work	<ul style="list-style-type: none"> ● Be sure power cord is plugged in. ● Check battery in Remote Control. 	<ul style="list-style-type: none"> ● Change batteries.

LIMITED UNITED STATES WARRANTY

Toshiba America Consumer Products, Inc. ("TACP") and Toshiba Hawaii Inc. ("THI") make the following limited warranties. These limited warranties extend to the original consumer purchaser or any person receiving this set as a gift from the original consumer purchaser and to no other purchaser or transferee.

Limited One (1) Year Warranty

TACP and THI warrant this product and its parts against defects in materials or workmanship for a period of one (1) year after the date of original retail purchase. During this period, TACP and THI will repair a defective product or part, without charge to you. You must deliver the entire set to an authorized TACP/THI Service Station. You pay for all transportation and insurance charges for the set to and from the Service Station.

Limited Two (2) Year Warranty of Picture Tube

TACP and THI further warrant the picture tube in this product against defects in materials or workmanship for a period of two (2) years after the date of original retail purchase. During this period, TACP and THI will replace a defective picture tube, but you must pay labor charges. You must also deliver the entire set to an Authorized TACP/THI Service Station. You pay for all transportation and insurance charges for the product to and from the Service Station.

Owner's Manual and Registration Card

You should read this owner's manual thoroughly before operating this product. You should also insure that your name and address are on file as owner's of a TACP/THI product by completing and mailing the enclosed registration card within ten days after you, or the person who has given you this product as a gift, purchased this product. This is one way to

enable TACP/THI to provide you with better customer service and improved products. Failure to return the card will not affect your rights under this warranty so long as you retain other proof of purchase such as a bill of sale.

Your Responsibility

The above warranties are subject to the following conditions:

- (1) You must retain your bill of sale or provide other proof of purchase.
Completing and mailing in the enclosed registration card within ten days after the original retail purchase is one way of providing such other proof of purchase.
- (2) All warranty servicing of this product must be made by an Authorized TACP/THI Service Station.
- (3) **These warranties are effective only if the product is purchased and operated in the U.S.A.**
- (4) Labor service charges for set installation, set up, adjustment of customer controls and installation of repair of antenna systems are not covered by this warranty. Reception problems caused by inadequate antenna systems are your responsibility.
- (5) Warranties extend only to defects in materials or workmanship as limited above and do not extend to any product or parts which have been lost or discarded by you or to damage to products or parts caused by misuse, accident, improper installation, improper maintenance or use in violation of instructions furnished by us; or to units which have been altered or modified without authorization of TACP/THI or to damage to products or parts there of which have had the serial number removed, altered, defaced or rendered illegible.

Step-By-Step Procedures-How to Obtain Warranty Service

If, after following all of the operating instructions in this manual and checking the section "BEFORE CALLING SERVICE PERSONNEL", you find that service is needed:

- (1) Contact one of the TACP/THI Service Centers listed below for warranty service or call the TACP toll free number **800-631-3811** within thirty (30) days after you find a defective product or part to find the nearest TOSHIBA Authorized Service Station or authorized TOSHIBA Dealer.
- (2) Arrange for the delivery of the product to the Authorized TACP/THI Service Station. Products shipped to the Service Station must be insured and safely and securely packed, preferably in the original shipping carton, and a letter explaining the defect and also a copy of the bill of sale or other proof of purchase must be enclosed. All transportation and insurance charges must be prepaid by you.
- (3) If you have any question about service, please contact one of the following TACP/THI Service Centers:

NORTHEAST	MIDWEST	WEST	SOUTHEAST	SOUTHWEST	HAWAII
82 Totowa Road, Wayne, New Jersey 07470	1010 Johnson Drive, Buffalo Grove, Illinois 60089-6900	5490 E. Francis St., Ontario, California 91761	6115 Jimmy Carter Blvd., Suite C2, Norcross, Georgia 30071-4607	1421 Champion Drive, Suite 304, Carrollton, Texas 75006	327 Kamakee Street, Honolulu, Hawaii 96814

IN THE CONTINENTAL UNITED STATES
Should your unit require service, Call



ALL WARRANTIES IMPLIED BY STATE LAW, INCLUDING THE IMPLIED WARRANTIES OF MERCHANTABILITY AND FITNESS FOR A PARTICULAR PURPOSE, ARE EXPRESSLY LIMITED TO THE DURATION OF THE LIMITED WARRANTIES SET FORTH ABOVE. Some states do not allow limitations on how long an implied warranty lasts, so the above limitation may not apply to you. **WITH THE EXCEPTION OF ANY WARRANTIES IMPLIED BY STATE LAW AS HEREBY LIMITED, THE FOREGOING EXPRESS WARRANTY IS EXCLUSIVE AND IN LIEU OF ALL OTHER WARRANTIES, GUARANTEES, AGREEMENTS AND SIMILAR OBLIGATIONS OF MANUFACTURER OR SELLER WITH RESPECT TO THE REPAIR OR REPLACEMENT OF ANY PRODUCT OR PARTS.**

IN NO EVENT SHALL TACP OR THI BE LIABLE FOR CONSEQUENTIAL OR INCIDENTAL DAMAGES. Some states do not allow the exclusion or limitation of incidental or consequential damages so the above limitation may not apply to you.

ATTENTION CANADIAN CUSTOMERS:

Canadian consumers are requested to complete the special Canadian "Warranty Registration form" enclosed. And forward this completed form with a copy of bill of sale to TOSHIBA OF CANADA to "Register and Validate" their warranty.

Before calling service personnel / Limited warranty

REFERENCE SECTION

Specifications

TELEVISION SYSTEM	NTSC standard
CHANNEL COVERAGE	VHF; 2 through 13 UHF; 14 through 69 Cable TV; mid band (A-8 through A-1, A through I) super band (J through W) hyper band (AA through ZZ, AAA, BBB) ultra band (65 through 94, 100 through 125)
POWER SOURCE	120V AC, 60Hz
POWER CONSUMPTION	52W (average)
AUDIO POWER	1W
SPEAKER TYPE	2-3/4 inches round
VIDEO/AUDIO TERMINALS	VIDEO INPUT: 1V(p-p), 75 ohm, negative sync. AUDIO INPUT: 150mV (rms) (30% modulation, 47k ohm)
DIMENSIONS	Width20 15/32 inches (520mm) Height17 13/32 inches (442mm) Depth18 25/64 inches (467mm)
MASS	34.4 lbs (15.6kg)
SUPPLIED ACCESSORIES	Remote Control with 2 size "AA" batteries

Design and specifications are subject to change without notice

TOSHIBA AMERICA CONSUMER PRODUCTS, INC.

HEAD OFFICE/82 TOTOWA ROAD, WAYNE, NEW JERSEY 07470

FACTORY SERVICE CENTERS/NORTHEAST: 82 TOTOWA ROAD, WAYNE, NEW JERSEY 07470

MIDWEST: 1010 JOHNSON DRIVE, BUFFALO GROVE, ILLINOIS 60089-6900

WEST: 5490 E. FRANCIS ST., ONTARIO, CA 91761

SOUTHWEST: 1421 CHAMPION DRIVE, SUITE 304 CARROLLTON, TEXAS 75006

SOUTHEAST: 6115 JIMMY CARTER BLVD., SUITE C2, NORCROSS, GA 30071-4607

TOSHIBA HAWAII, INC.

HEAD OFFICE/327 KAMAKEE STREET, HONOLULU, HAWAII 96814, U.S.A.

TOSHIBA OF CANADA LTD.

HEAD OFFICE/191 MCNABB STREET, MARKHAM, ONTARIO, L3R 8H2, CANADA TEL: (905) 470-5400

SERVICE CENTERS/TORONTO: 191 MCNABB STREET, MARKHAM, ONTARIO, L3R 8H2, CANADA TEL: (905) 470-5400

MONTREAL: 1643, NORTH SERVICE RD., TRANS-CANADA HIGHWAY, DORVAL QUEBEC, H9P 1J1, CANADA

TEL: (514) 332-6860

VANCOUVER: 3870 JACOMBS ROAD, RICHMOND, B.C., V6V 1Y6, CANADA TEL: (604) 270-8481

MANUFACTURED BY

TOSHIBA AMERICA CONSUMER PRODUCTS, INC.

PRINTED IN USA

(95-01)

TOSHIBA